



**HARLEY-DAVIDSON® GENUINE MOTORCYCLE
PARTS & ACCESSORIES**

MODEL INFORMATION						
YEAR:	MODEL:	ALPHA CODE:	FAMILY:	COLOR:	ENGINE TYPE:	DISPLACEMENT:

HARLEY-DAVIDSON MODELS – 1984 to 2022W (excluding LiveWire, V-Rod, FX and FXR models)

REVOLUTION MAX® FAMILY			
PAN AMERICA™	RA1250	'21-CURRENT	
PAN AMERICA™ SPECIAL	RA1250S	'21-CURRENT	
SPORTSTER® S	RH1250S	'21-CURRENT	
NIGHSTER	RH975	'22-CURRENT	
NIGHSTER SPECIAL	RH975S	'23 -CURRENT	

STREET™ FAMILY			
HARLEY-DAVIDSON STREET® 500	XG500	'15-'21	
HARLEY-DAVIDSON STREET 750	XG750	'15-'21	
STREET ROD®	XG750A	'17-'21	

SPORTSTER® FAMILY			
SPORTSTER® 1000	XLH	'84-'85	
SPORTSTER 883	XLH883/XL883	'86-'08	
SPORTSTER 883 CUSTOM	XLH883C/XL883C	'99-'09	
SPORTSTER 883 DELUXE	XLH883 DLX	'88-'95	
SPORTSTER 883 HUGGER™	XLH883 HUG	'88-'03	
SPORTSTER 1100 / 1200	XLH1100 / XLH1200	'86-'87 / '88-'03	
SPORTSTER 1200 CUSTOM	XLH1200C/XL1200C	'96-'20	
SPORTSTER 1200 SPORT	XL1200S	'96-'03	
SPORTSTER 883 LOW	XL883L	'05-'10	
SPORTSTER SUPERLOW®	XL883L	'11-'20	
SPORTSTER 883 IRON™	XL883N	'09-'22	
SPORTSTER 883R	XL883R	'02-'03, '05-'07	
SPORTSTER ROADSTER®	XL1200CX	'16-'20	
SPORTSTER 1200 LOW	XL1200L	'06-'11	
SPORTSTER 1200 NIGHTSTER™	XL1200N	'07-'12	
SPORTSTER IRON 1200™	XL1200NS	'18-'20	
SPORTSTER 1200 ROADSTER	XL1200R	'04-'08	
SPORTSTER SUPERLOW 1200T	XL1200T	'14-'17	
SPORTSTER SEVENTY-TWO®	XL1200V	'12-'16	
SPORTSTER FORTY-EIGHT®	XL1200X	'10-'22	
SPORTSTER FORTY-EIGHT® SPECIAL	XL1200XS	'18-'20	
50TH ANNIVERSARY SPORTSTER	XL50	'07	
ROADSTER	XLS	'84-'85	
XLX-61	XLX	'84-'86	
XR-1000	XR-1000	'84-'85	
XR1200™ / XR1200X™	XR1200 / XR1200X	'08-'10 / '11-'13	

DYNA® FAMILY			
SWITCHBACK™	FLD	'12-'16	
DYNA SUPER GLIDE®	FXD/I	'95-'10	
STREET BOB®	FXDB/I	'06-'17	
DYNA SUPER GLIDE CUSTOM	FXDC/I	'05-'14	
FAT BOB®	FXDF	'08-'17	
CVO FAT BOB	FXDFSE	'09-'10	
DYNA LOW RIDER	FXDL/I	'93-'09, '14-'17	
DYNA LOW RIDER S	FXDLS	'16-'17	
DYNA CONVERTIBLE	FXDS CONV	'94-'00	
SCREAMIN' EAGLE® DYNA	FXDSE	'07-'08	
DYNA WIDE GLIDE®	FXDWG/I	'93-'08, '10-'17	
CVO DYNA WIDE GLIDE	FXDWG2/3	'01-'02	
DYNA SUPER GLIDE SPORT	FXDX/I	'99-'05	

SOFTAIL® FAMILY – MILWAUKEE-EIGHT®			
SOFTAIL® DELUXE	FLDE	'18-'20	
FAT BOY®	FLFB/S	'18-CURRENT	
HERITAGE SOFTAIL® CLASSIC	FLHC/S	'18-CURRENT	
SOFTAIL SLIM®	FLSL	'18-'21	
SPORT GLIDE™	FLSB	'18-'21	
STREET BOB®	FXBB/S	'18-CURRENT	
BREAKOUT®	FXBR/S	'23-CURRENT	
FXDR 114	FXDRS	'19-'20	
FAT BOB®	FXFB/S	'18-CURRENT	
LOW RIDER®	FXLR	'18-'20	
LOW RIDER® S	FXLRS	'20-CURRENT	
LOW RIDER® ST	FXLRST	'22-CURRENT	
SOFTAIL® STANDARD	FXST	'21-CURRENT	

SOFTAIL® FAMILY – EVOLUTION® 1340/TWIN CAM			
SOFTAIL SLIM®	FLS	'12-'17	
SOFTAIL SLIM S	FLSS	'16-'17	
HERITAGE SOFTAIL®	FLST/I	'86-'90, '06	
HERITAGE SOFTAIL CLASSIC	FLSTC/I	'88-'17	
CROSS BONES®	FLSTSB	'08-'11	
SOFTAIL SPRINGER™ CLASSIC	FLSTSC/I	'05-'07	
CVO™ SOFTAIL CONVERTIBLE	FLSTSE	'10-'12	
FAT BOY®	FLSTF/I	'90-'17	
FAT BOY LO/SPECIAL	FLSTFB	'10-'16	
FAT BOY S	FLSTFBS	'16-'17	
CVO FAT BOY	FLSTFSE	'05-'06	
HERITAGE SOFTAIL SPECIAL/NOSTALGA	FLSTN	'93-'96	
SOFTAIL DELUXE	FLSTN/I	'05-'17	
CVO DELUXE	FLSTNSE	'14-'17	
HERITAGE SPRINGER®	FLSTS/I	'97-'03	
ROCKER™	FXCW	'08-'09	
ROCKER C	FXCWC	'08-'11	
BLACKLINE®	FXS	'11-'13	
BREAKOUT®	FXSB	'13-'17	
CVO BREAKOUT	FXSBSE	'13-'14	
CVO PRO STREET BREAKOUT	FXSE	'16-'17	
SOFTAIL/SOFTAIL STANDARD	FXST/I	'84-'90, '99-'15	
NIGHT TRAIN™	FXSTB/I	'98-'09	
SOFTAIL CUSTOM	FXSTC	'86-'99, '07-'10	
SOFTAIL DEUCE™	FXSTD/I	'00-'07	
CVO DEUCE	FXSTDSE	'03-'04	
SPRINGER SOFTAIL	FXSTS/I	'88-'06	
BAD BOY	FXSTSB	'95-'97	
CVO SPRINGER SOFTAIL	FXSTSSE	'07-'09	

TOURING FAMILY			
ROAD KING®	FLHR/I	'94-'22	
ROAD KING CLASSIC	FLHRC/I	'98-'19	
ROAD KING CUSTOM	FLHRS/I	'04-'07	
ROAD KING SPECIAL	FLHRXS	'17-CURRENT	
CVO ROAD KING	FLHRSE	'02-'03, '07-'08, '13-'14	
ELECTRA GLIDE®	FLH	'84-'85	
ELECTRA GLIDE SPECIAL	FLHX	'84-'85	
ELECTRA GLIDE SPORT	FLHS	'84, '87-'93	
ELECTRA GLIDE STANDARD	FLHT/I	'86-'87, '95-'09, '19-'22	
ELECTRA GLIDE CLASSIC	FLHTC/I	'84-'13	
CVO ELECTRA GLIDE	FLHTCSE	'04-'05	
ELECTRA GLIDE ULTRA CLASSIC®	FLHTCU/I	'89-'19	
ELECTRA GLIDE ULTRA CLASSIC TWIN-COOLED™	FLHTCU TC	'14-'19	
ELECTRA GLIDE ULTRA CLASSIC LOW	FLHTCUL	'15-'16	
ELECTRA GLIDE ULTRA CLASSIC LOW TWIN-COOLED	FLHTCUL TC	'15-'16	
CVO ELECTRA GLIDE ULTRA CLASSIC	FLHTCUSE	'06-'13	
STREET GLIDE®	FLHX	'06-CURRENT	
STREET GLIDE SPECIAL	FLHXS	'14-CURRENT	
STREET GLIDE ST	FLHXST	'22-CURRENT	
CVO STREET GLIDE	FLHXSE	'10-'12, '15-CURRENT	
ULTRA LIMITED	FLHTK	'10-CURRENT	
ULTRA LIMITED LOW	FLHTKL	'15-'19	
CVO LIMITED	FLHTKSE	'14-CURRENT	
TOUR GLIDE™ CLASSIC	FLTC	'84-'91	
ULTRA CLASSIC TOUR GLIDE	FLTCU/I	'89-'96	
ROAD GLIDE®	FLTR/I, FLTRX	'98-'09, '15-CURRENT	
CVO ROAD GLIDE	FLTRSE	'00-'01, '09	
ROAD GLIDE ULTRA	FLTRU	'11-'13, '16-'19	
CVO ROAD GLIDE ULTRA	FLTRUSE	'11, '15-'16	
ROAD GLIDE CUSTOM	FLTRX	'10-'13	
ROAD GLIDE SPECIAL	FLTRXS	'15-CURRENT	
ROAD GLIDE ST	FLTRXST	'22-CURRENT	
ROAD GLIDE LIMITED	FLTRK	'20-CURRENT	
CVO ROAD GLIDE CUSTOM	FLTRXSE	'12-'13, '18	

TRIKE FAMILY			
TRI GLIDE® ULTRA CLASSIC	FLHTCUTG	'09-CURRENT	
CVO TRI GLIDE	FLHTCUTGSE	'20	
STREET GLIDE TRIKE	FLHXXX	'10-'11	
FREEWHEELER®	FLRT	'15-CURRENT	
ROAD GLIDE 3	FLTRT	'23-CURRENT	

PAN AMERICA™			
PACKAGES		12	
WINDSHIELDS		16	
SEATS		18	
VEHICLE PROTECTION		20	
LUGGAGE		22	
PERFORMANCE		26	
CHASSIS TRIM		27	
WHEELS		28	
MAINTAINANCE		28	

SPORT			
PACKAGES		15	
WINDSHIELDS		30	
SEATS		32	
LUGGAGE		35	
CONTROLS		36	
COLLECTIONS AND TRIM		37	

CRUISER - SPORTSTER®			
WINDSHIELDS		58	
SEATING		60	
BACKRESTS & RACKS		64	
SADDLEBAGS		64	
SUSPENSION		70	
HAND & FOOT CONTROLS		72	
ENGINE GUARDS		74	
CHASSIS TRIM – FRONT END		76	

CRUISER - DYNA®			
WINDSHIELDS		82	
SEATING		86	
BACKRESTS & RACKS		91	
LUGGAGE		96	
SUSPENSION		97	
FOOT CONTROLS		98	
ENGINE GUARDS & HIGHWAY PEGS		101	
CHASSIS TRIM – FRONT END		102	

CRUISER - MILWAUKEE-EIGHT® SOFTAIL®			
WINDSHIELDS		106	
SEATING		113	
BACKRESTS & RACKS		123	
SADDLEBAGS		128	
LUGGAGE		133	
SUSPENSION		134	
HAND & FOOT CONTROLS		135	
ENGINE GUARDS		142	
AUDIO		144	
CHASSIS TRIM – FRONT END		145	
CHASSIS TRIM – REAR END		147	

CRUISER - TWIN-CAM SOFTAIL®			
WINDSHIELDS		150	
SEATING		154	
BACKRESTS & RACKS		160	
SADDLEBAGS		166	
FOOT CONTROLS		170	
ENGINE GUARDS & HIGHWAY PEGS		175	
CHASSIS TRIM – FRONT END		176	
CHASSIS TRIM – REAR END		182	
CHASSIS TRIM – ENGINE & FENDERS		188	

TOURING & TRIKE			
WINDSHIELDS		218	
FAIRING LOWERS & ACCESSORIES		234	
COOLFLOW™ FAN & OIL FANS		236	
SEATING		240	
BACKRESTS & RACKS		250	
TOUR-PAK® & ACCESSORIES		264	
SADDLEBAGS & ACCESSORIES		271	
LUGGAGE ACCESSORIES		274	
FOOT CONTROLS		280	
ENGINE GUARDS & CENTER STANDS		288	
SUSPENSION & FRONT END		290	
CHASSIS TRIM – FAIRING & CONSOLE		306	
CHASSIS TRIM – REAR END		315	
CHASSIS TRIM – REAR LIGHTING		316	
AUXILIARY POWER & CHARGING		320	
PAINT PROTECTION		325	

SCREAMIN' EAGLE®			
STREET TUNER		332	
MILWAUKEE-EIGHT® POWERTRAIN		334	
TWIN-CAM POWERTRAIN		370	
SPORTSTER® POWERTRAIN		394	
AIR FILTERS & SPARK PLUGS		406	
CRATE ENGINES & TRANSMISSIONS		409	

ENGINE TRIM			
COLLECTIONS		422	
MILWAUKEE-EIGHT™ ACCESSORIES		438	
TWIN CAM ACCESSORIES		444	
AIR CLEANER COVERS		454	
HARDWARE & HARDWARE COVERS		458	

CONTROLS			
HAND & FOOT CONTROL COLLECTIONS		468	
HIGHWAY PEGS & FOOTPEG HARDWARE		500	
FOOTPEGS & FOOTBOARDS		504	
MIRRORS		506	
HAND CONTROLS & LEVERS		510	
HANDLEBARS		518	
HANDLEBAR RISERS & CABLES		541	

AUDIO & GAUGES			
HARLEY-DAVIDSON® AUDIO POWERED BY ROCKFORD FOSGATE®		548	
BOOM!™ AUDIO – TOURING BIKES		562	
BOOM! AUDIO – STAGE I		564	
BOOM! AUDIO – STAGE II		568	
HEADSETS		576	
PHONE MOUNTS & ACCESSORIES		582	
GPS NAVIGATION & SIRIUSXM™		576	
ANTENNA SYSTEMS		585	
AUXILIARY POWER & CHARGING		586	
GAUGES		587	
CLOCKS & AIR TEMP		590	
FUEL GAUGES, CAPS & MEDALLIONS		591	

LIGHTING			
SPECTRA GLO™ & LED CUSTOM LIGHTING		596	
HEADLAMPS & AUXILIARY LIGHTING		599	
HEADLAMP TRIM		606	
TURN SIGNALS		611	
TAIL & BRAKE LAMPS		621	
LICENSE MOUNTS & ACCESSORIES		626	
HORNS & HORN COVERS		629	

WHEELS			
CUSTOM WHEELS		634	
BRAKE ROTORS		642	
SPROCKETS		644	
WHEEL ACCESSORIES		645	

LUGGAGE			
TOURING LUGGAGE & ACCESSORIES		648	
WINDSHIELD & FAIRING BAGS		655	
TIE-DOWNS & ACCESSORIES		656	
FLAGS		658	

COLOR SHOP			
COLOR-MATCHED ACCESSORIES		662	
PAINTS		676	
MEDALLIONS & DECALS		677	

GARAGE			
OIL		682	
OIL CHANGE ACCESSORIES		688	
LUBES AND SEALENTS		690	
SURFACE CARE PRODUCTS		692	
MOTORCYCLE COVERS		700	
GARAGE STORAGE		704	
MOTORCYCLE LIFTS & TIE-DOWNS		705	
SECURITY LOCKS & SYSTEMS		707	
BATTERY CHARGERS		714	
BATTERIES		717	
TOOLS		718	
AIR FILTERS		720	
SPARK PLUGS		722	
BRAKE PADS		723	
TIRE GAUGES & AIR PUMPS		724	

INDEX			
ALPHABETIC INDEX		740	
PAGE NUMBER/PART NUMBER INDEX		747	
WARRANTY INFORMATION		IBC	



Front Axle Guards

20



Rear Brake Reservoir Guard

20



Offroad Adjustable Brake Lever

27



Offroad Folding and Adjustable Shift Lever Kit

27

HARLEY-DAVIDSON® ADVENTURE TOURING - RA1250

PAN AMERICA 1250

This bike is ready to tackle dirty work. An Offroad Brake Lever and Folding Shift Lever can be height-adjusted trail-side for comfort and control when standing on the pegs. Rugged aluminum guard protects the rear brake reservoir and the Front Axle Guard protects the axle from damage in a low-speed tip-over event. Stand for adventure.



Adventure 18-inch Windshield

16

HARLEY-DAVIDSON® ADVENTURE TOURING - RA1250S

PAN AMERICA 1250 SPECIAL

Make quick work of the road ahead. A Screamin' Eagle® Quickshifter enables clutchless, seamless up and downshifts. Make your getaway with rugged Black Aluminum Top and Side Cases and a stout Muffler Guard. Tuck in behind the 18-inch Adventure Windshield. Feel unstoppable.



Black Aluminum Top Case

22



Screamin' Eagle Quickshifter

26



Muffler Guard

20



Tracker Handlebar

38

HARLEY-DAVIDSON® SPORT - RH1250S

SPORTSTER S

One for the road. Roll solo and experience enhanced agility on backroads and urban streets with Mid-Controls and a wide Tracker Handlebar. Empty your pockets and stash essentials in our updated Single-Sided Swingarm Bag. '66 Collection Footpegs, Hand Grips and Cam Sprocket Medallions add undeniable style.



'66 Collection Hand Grips

470



Single-Sided Swingarm Bag - Modern Style

35



Mid-Control Kit

36



Mini-Ape Handlebar

527

HARLEY-DAVIDSON® SPORT - RH975

NIGHTSTER

Amp up the attitude with a black Mini-Ape Handlebar and a black side-draft Velocity Stack intake. Accessories from the '66 Collection provide handcrafted style. Stick your stash in the classic leather Single-Sided Swingarm Bag. Tough enough for the gritty city.



Velocity Stack

39



'66 Collection Rider Footpegs

470



Single-Sided Swingarm Bag - Classic Style

35



Velocity Stack

39

HARLEY-DAVIDSON® SPORT - RH975S

NIGHTSTER SPECIAL

Details make this machine extra special. Machined forged billet Adversary™ Collection Engine Trim, Alternator Plug Cover and a raw side-draft Velocity Stack intake. Cover the front axle in style with these smooth custom, die-cast Front Axle Nut Covers. You're ready for your day (or night) on the prowl.



Adversary Collection Engine Trim

425



Front Axle Nut Covers

41



Adversary Collection Alternator Plug Cover

425

ULTIMATE TREKKER PACKAGE - PAN AMERICA®

Kickstart your customization journey and make it as seamless as possible with the Pan America® Model Ultimate Trekker Custom Package from H-D® Genuine Parts & Accessories. Ready for your ultimate trek. Head out for a weekend or around the world with a collection of accessories designed to support the biggest adventure tour. Rugged detachable luggage for all your gear. Added protection for rider and motorcycle. How far will you go?

Includes: Aluminum Side Cases, Aluminum Top Case, Passenger Backrest Pad, Muffler Guard, Tank Knee Pad Kit, SE Extreme Flow Air Filter, 18" Windshield Kit, Headlight Guard, Radiator Shield, Skid Plate, Daymaker® LED Auxiliary Lights, Screamin' Eagle® Quick Shifter. Available exclusively in Dealerships – See your Dealer for details.

50700098

\$4,434.95

Fits '22-later RA1250 and RA1250S models. RA1250 models require separate purchase of Brush Guard P/N 49000192. Installation requires dealer Digital Technician® update.



Aluminum Side Cases Daymaker LED Auxiliary Lights Headlight Guard 18" Windshield Kit Radiator Shield Passenger Backrest Pad Aluminum Top Case Screamin' Eagle Quick Shifter

Notice: Some Kit items not shown: Muffler Guard, Tank Knee Pad Kit, SE Extreme Flow Air Filter and Skid Plate. Kit may include additional components required for complete installation. The prices appearing in this catalog are the manufacturer's suggested retail prices. Actual retail prices may vary.

MIDNIGHT PACKAGE - PAN AMERICA®

Kickstart your customization journey and make it as seamless as possible with the Pan America® Model Midnight Custom Package from H-D® Genuine Parts & Accessories. Travel in stealth mode. A black-out beauty equipped with a select collection of accessories designed to support the biggest adventure tour. Performance upgrades. Rugged luggage for all your gear. Added protection for rider and motorcycle. How far will you go?

Includes: Adventure Soft Saddlebags, Adventure Duffle Bag, Tank Bag, Muffler Guard, Headlight Guard, Skid Plate, 11" Windshield Kit, Daymaker® LED Auxiliary Lights, Screamin' Eagle® Quick Shifter, Screamin' Eagle® Extreme-Flow Air Filter and Tank Knee Pad Kit. Available exclusively in Dealerships – See your Dealer for details.

50700101

\$3,296.95

Fits '22-later RA1250 and RA1250S models. RA1250 models require separate purchase of Brush Guard P/N 49000192. Installation requires dealer Digital Technician® update.



Adventure Duffle Bag Tank Bag Adventure Soft Saddlebags Daymaker LED Auxiliary Lights Skid Plate Muffler Guard Screamin' Eagle Quick Shifter

Notice: Some Kit items not shown: Headlight Guard, 11" Windshield Kit, Screamin' Eagle Extreme-Flow Air Filter and Tank Knee Pad Kit. Kit may include additional components required for complete installation. The prices appearing in this catalog are the manufacturer's suggested retail prices. Actual retail prices may vary.

GREAT ESCAPE PACKAGE - PAN AMERICA®

Kickstart your customization journey and make it as seamless as possible with the Pan America® Model Great Escape Custom Package from H-D® Genuine Parts & Accessories. Ready for the daily commute or a week-long tour equipped with a select collection of accessories designed for versatility, comfort and performance. Detachable luggage. Performance upgrades. Wind and weather protection. Where does your road lead?

Includes: Sport Side Cases, Sport Top Case, Side Case Liners, Top Case Liner, Tank Bag, Screamin' Eagle® Extreme-Flow Filter, Screamin' Eagle® Quick Shifter, 18" Windshield Kit, and Daymaker® LED Auxiliary Lights.

Available exclusively in Dealerships – See your Dealer for details.

50700102

\$3,351.95

Fits '22-later RA1250 and RA1250S models. RA1250 models require separate purchase of Brush Guard P/N 49000192. Installation requires dealer Digital Technician® update.



Tank Bag Sport Side Cases Side Case Liners Sport Top Case Top Case Liner Daymaker LED Auxiliary Lights 18" Windshield Kit Screamin' Eagle Quick Shifter

Notice: Some Kit items not shown: Screamin' Eagle Extreme-Flow Filter. Kit may include additional components required for complete installation. The prices appearing in this catalog are the manufacturer's suggested retail prices. Actual retail prices may vary.

WILD ONE PACKAGE - SPORTSTER® S

Kickstart your customization journey and make it as seamless as possible with the Sportster® S Model Wild One Custom Package from H-D® Genuine Parts & Accessories. Add raw and rugged style. Wild One Collection powertrain and control accessories feature a gleaming black finish with bright machined highlights. The look is powerful.

Includes: Wild One Collection – Hand Grips, Rider Footpegs, Rear Brake Lever, Shifter Peg, Cam Sprocket Medallions, Alternator Plug Cover, Clutch Medallion, Timer Medallion and the Mid-Control Kit. Available exclusively in Dealerships See your Dealer for details.

50700104

\$1,666.95

Fits '21-later RH1250S models.



Hand Grips Rider Footpegs Front Axle Covers Alternator Plug Cover Cam Sprocket Medallions Timer Medallion

Notice: Some Kit items not shown: Rear Brake Lever, Shifter Peg, Clutch Medallion and Mid-Control Kit. Kit may include additional components required for complete installation.

ADVERSARY PACKAGE - NIGHTSTER™

Kickstart your customization journey and make it as seamless as possible with the Nightster™ model Adversary™ Custom Package from H-D® Genuine Parts & Accessories. Black and orange. A classic color combination applied to forged billet aluminum Adversary Collection accessories for a look that's tight and technical.

Includes: Adversary Collection Cam Sprocket Medallions, Adversary Clutch Medallion, Adversary Timer Medallion, Adversary Alternator Plug Cover, Adversary Shifter Peg, Adversary Mirrors, Adversary Hand Grip, Adversary Hand Grip End Cap; Black Velocity Stack. Available exclusively in Dealerships – See your Dealer for details.

50700100

\$1,053.95

Fits '22-later RH975 and RH975S models.



Adversary Hand Grips Adversary Mirrors Black Velocity Stack Alternator Plug Cover Timer Medallion Cam Sprocket Medallions

Notice: Some Kit items not shown: Adversary Clutch Medallion, Adversary Shifter Peg and Adversary Hand Grip End Cap. Kit may include additional components required for complete installation. The prices appearing in this catalog are the manufacturer's suggested retail prices. Actual retail prices may vary.

16 PAN AMERICA®

Windshields

A. ADVENTURE WINDSHIELD – 18" CLEAR

This windshield is approximately 2.5 inches taller than the Original Equipment windshield for added protection from the elements.

57400454 **\$173.95**
Fits '21-later RA1250 and RA1250S models.

B. ADVENTURE WINDSHIELD

This windshield is approximately 4.5 inches lower than the Original Equipment windshield and allows most riders to see over the windshield.

Fits '21-later RA1250 and RA1250S models.
57400456 11" Dark Smoke. **\$142.95**
57400499 11" Clear. **\$131.95**

C. TANK KNEE PAD KIT – PAN AMERICA®

These self-adhesive black rubber pads are easy to install and feature tapered raised ridges that complement the styling of the seat, and add traction and comfort when knees grip the tank. The two-piece kit offers protection for surfaces where rider legs and riding gear contact the tank.

57300291 **\$54.95**
Designed for RA1250 and RA1250S models, but will fit other fuel tanks. May cover a portion of fuel tank graphics. Check appearance before adhering to tank.



A. ADVENTURE WINDSHIELD – 18" CLEAR



B. ADVENTURE WINDSHIELD – 11" DARK SMOKE



C. TANK KNEE PAD KIT



D. DAYMAKER ADAPTIVE HEADLAMP UPGRADE KIT



D. DAYMAKER LED FORWARD AUXILIARY LIGHTS



E. DAYMAKER LED FORWARD AUXILIARY LIGHTS



E. DAYMAKER LED FORWARD AUXILIARY LIGHTS

PAN AMERICA® 17

Lighting

D. DAYMAKER® ADAPTIVE HEADLAMP UPGRADE KIT – PAN AMERICA®

See more road at night. Daymaker® Adaptive Headlamp technology utilizes motorcycle sensors to determine the lean angle of the bike and automatically projects additional light into corners to illuminate areas of the road that may be unlit by an LED headlamp without this technology. The system includes three LED elements per side in a separate lighting unit located above the main Daymaker LED headlamp. The LED elements illuminate in sequence based on motorcycle lean angle, at 8 degrees, 15 degrees and 23 degrees. Each element will fade on during the activation and off during deactivation, appearing seamless to the rider. The system functions when the headlight is in either high-beam or low-beam mode. Engineered by Harley-Davidson® for ideal fit and function. Original Equipment on the Pan America® 1250 Special model.

69202757 **\$611.95**
Fits '21-later RA1250 models. Original Equipment on RA1250S models.

E. DAYMAKER LED FORWARD AUXILIARY LIGHTS*

These rugged auxiliary LED lights offer three-way function that will serve the adventure touring rider in any situation. Installed as a pair, each light has a three-beam, four-lens design within durable aluminum housing. In daylight these lights also make the motorcycle more conspicuous to other motorists. The factory-integrated design makes these lights easy to install and a perfect fit and look on the bike. Three-way functionality: Fog lights produce a wide pool of light directly in front of the motorcycle to light the edge of the road in low-visibility conditions. Driving lights punch light further down the road to augment headlight performance. Off-Road beams deliver 275-meter forward visibility and 50-meter side visibility to light up the trail (not street legal). Powder coated lightweight aluminum housing. High-impact hard-coated and anti-fog coated outer lens. Installation requires separate purchase of Auxiliary Light Installation Kit.

68000340 **\$532.95**
Fits '21-later RA1250 and RA1250S models equipped with Original Equipment Brush Guard or accessory Brush Guard P/N 49000192, and '14-later Touring models. Separate purchase of model-specific installation kit is required.

Also available: AUXILIARY LIGHT INSTALLATION KIT – PAN AMERICA

Installation kit includes a wiring harness, mounting brackets, and switch pack for installing Daymaker® LED Forward Auxiliary Lights.

68000343 **\$170.95**
Fits '21-later RA1250 and RA1250S models.

18 PAN AMERICA®

Seats

A. SUNDOWNER™ SOLO SEAT - PAN AMERICA®

Have miles to ride before you sleep? The new Sundowner™ Solo Seat for Harley-Davidson® Pan America® 1250 models can help keep you comfortable and alert until the next gas stop or camp site. Its enhanced bucket shape and spherical-void foam construction is designed to reduce numbing pressure points, and waterproof construction means you won't have a soggy bum after the rain quits. Factory fit retains your bike's tool storage and high/low position features. Treat your passenger to a matching Sundowner™ Pillion (sold separately) for two-up comfort.

52000478 **\$368.95**

Fits '21-later RA1250 and RA1250S models.



A. SUNDOWNER SOLO SEAT - PAN AMERICA

B. SUNDOWNER PASSENGER PILLION - PAN AMERICA

Provides a passenger Sundowner comfort with style that matches the Sundowner seat. Wider shape than Original Equipment pillion for added passenger comfort and confidence when riding on or off road. Designed for Original Equipment mounting points and does not compromise rider seat features. Waterproof construction and seam sealed stitch lines prevent water from soaking into the foam and leaving the rider with a damp bum.

52400249 **\$168.95**

Fits '21-later RA1250 and RA1250S models equipped with Sundowner Solo Seat P/N 52000478.



B. SUNDOWNER PASSENGER PILLION - PAN AMERICA

C. REACH® SOLO SEAT – PAN AMERICA

The Reach® Solo Seat lowers seat height by 1 inch to optimize fit for riders of shorter stature, while retaining full functionality. Helps many riders get feet down with confidence at a stop. Retains the two-position seat adjustability feature to fine-tune rider ergonomics. Retains easy access to under seat tool storage. Replaces only the rider seat position. Matches the style of the Original Equipment seat.

52000471 **\$266.95**

Fits '21-later RA1250 and RA1250S models.



C. REACH SOLO SEAT – PAN AMERICA

D. TALLBOY® SOLO SEAT – PAN AMERICA

For riders with a longer inseam, a Tallboy® Seat moves the rider up from the stock seating position and places the body for a natural arm and leg reach to the controls. The Tallboy Seat increases seat height by 1". Opens the rider's hip/knee/ankle angles for more comfort, especially over longer distances. Gives the rider a more-commanding position and view of the road or trail ahead. Retains the two-position seat adjustability feature to fine-tune rider ergonomics. Retains easy access to under seat tool storage. Replaces only the rider seat position. Matches the style of the Original Equipment seat.

52000472 **\$266.95**

Fits '21-later RA1250 and RA1250S models.



D. TALLBOY SOLO SEAT – PAN AMERICA



Reach Seats



Tallboy Seats

Notice: The prices appearing in this catalog are the manufacturer's suggested retail prices. Actual retail prices may vary.

PAN AMERICA® 19

Adventure Hand Controls

E. TACTICAL HAND GRIPS

A black rubber grid pattern with deep grooves provides outstanding grip for rider comfort and confidence in any riding condition.

56100402 **\$85.95**

Fits '21-later RA1250 and RH1250S models. Does not fit models with original equipment heated grips. Models with Bar End Mirrors require separate purchase of P/N 55801095 qty (2).



E. TACTICAL HAND GRIPS



F. TACTICAL HEATED HAND GRIPS

F. TACTICAL HEATED HAND GRIPS

Get more comfort and control with these heated grips. Heat settings are controlled with a military grade resistor, and use a thermostat to automatically monitor and adjust heat output relative to the ambient temperature. A heating element wound internally to the grips provides consistent and even heating. The grips feature a black rubber grid pattern with deep grooves that provide outstanding grip for rider comfort and confidence in any riding condition.

56100401 **\$182.95**

Fits '21-later RA1250S, RH1250S and RH975S models. RH1250S and RH975S models require a Digital Tech update by a Harley-Davidson® dealer.

G. WILD ONE™ HEATED HAND GRIPS

Add daring, raw-and-rugged style with durable billet aluminum Wild One™ Collection accessories. Each is finished in gloss black with bright, machined aluminum highlights, a variety of textures and exposed hardware to communicate power, speed, and performance. These thermostatically controlled grips feature variable heat settings controlled with a military grade resistor, and use automatic temperature monitoring to adjust to ambient temperatures. Grips have been thermally mapped to provide more-uniform heat and are designed to achieve a maximum operating temperature approximately 20° Fahrenheit warmer than previous accessory heated grips for added warmth during cold morning or frigid night rides.

56100483 Heated. **\$244.95**

Fits '21-later RA1250S, RH1250S and RH975S models. RH1250S and RH975S models require a Digital Tech update by a Harley-Davidson dealer.



G. WILD ONE™ HEATED HAND GRIPS



H. EMPIRE™ COLLECTION – HEATED HAND GRIPS

H. EMPIRE™ COLLECTION – HEATED HAND GRIPS

Combine style and comfort for cool morning or frigid night rides. These thermostatically controlled grips feature variable heat settings controlled with a military grade resistor, and use automatic temperature monitoring to adjust to ambient temperatures. Grips have been thermally mapped to provide a more-uniform heat and are designed to achieve a maximum operating temperature approximately 20° Fahrenheit warmer than previous accessory heated grips for added warmth during cold rides.

Fits '21-later RA1250S, RH1250S and RH975S models. RH1250S and RH975S models require a Digital Tech update by a Harley-Davidson dealer.

56100487 Black. **\$245.95**

56100488 Black Machine Cut. **\$255.95**

I. PAN AMERICA® TALL RISERS

Gain comfort with these Tall Risers, which move the handlebar up and back 2 inches compared to the stock riser. Improves seated reach for riders with shorter arm length. Improves control and comfort when the rider is standing on the foot pegs for off-road travel.

55900241 **\$191.95**

Fits '21-later RA1250 and RA1250S models.



I. PAN AMERICA TALL RISERS

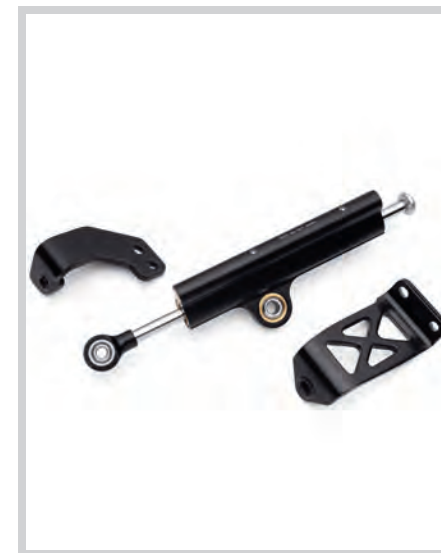

J. PAN AMERICA STEERING DAMPER KIT

J. PAN AMERICA STEERING DAMPER KIT

Rocks. Ruts. That deep sand washes. Ride it all with more confidence after installing this Ohlins™ steering damper kit, designed and validated by Harley-Davidson specifically for the Pan America® 1250 model. This premium steering damper enhances dynamic performance, especially during aggressive off-road riding. You'll moto with less fatigue and enhanced control. Get out there. Reduces fatigue by damping handlebar motion while off-road. Kit includes bracket, damper, and necessary installation hardware. Factory designed for ideal fit and function.

45700068 **\$419.95**

Fits '21-later RA1250 models. Original Equipment on RA1250S models.

Notice: The prices appearing in this catalog are the manufacturer's suggested retail prices. Actual retail prices may vary.

20 PAN AMERICA®

Vehicle Protection

A. SKID PLATE

Tackle tough off-road situations with confidence. The accessory Skid Plate replaces the Original Equipment skid plate for added protection from flying rocks and impacts during off-road riding. Heavy-duty aluminum construction. The factory-integrated design ensures proper fit and easy installation. The Skid Plate also gives the motorcycle extra rugged style.

49000191 **\$378.95**
Fits '21-later RA1250 and RA1250S models.



A. SKID PLATE

B. MUFFLER GUARD

Tackle tough off-road situations with confidence. This rugged, tubular steel guard is designed to protect the muffler from damage during a tip-over event. The factory-integrated design ensures a perfect fit and easy installation.

47200732 **\$170.95**
Fits '21-later RA1250 and RA1250S models.



B. MUFFLER GUARD

C. FRONT AXLE GUARDS

Durable engineered materials are designed to protect the Pan America® 1250 model front axle from damage in a low-speed tip-over event. Polyamide guard with a reinforced plastic core and TPU coating is abrasion resistant with excellent mechanical damping capabilities to protect the axle in a low-speed tip-over event. Axle thread and spacers for easy installation on Pan America models. Axle thread and spacers for easy installation on Pan America models. Embossed Harley-Davidson script logo. Sold as a set of two guards.

43000303 **\$106.95**
Fits '21-later RA1250 and RA1250S models.



C. FRONT AXLE GUARDS

D. REAR AXLE GUARDS

Durable engineered materials are designed to protect the Pan America 1250 model rear axle from damage in a low-speed tip-over event. Polyamide guard with a reinforced plastic core and TPU coating is abrasion resistant with excellent mechanical damping capabilities to protect the axle in a low-speed tip-over event. Axle thread and spacers for easy installation on Pan America 1250 models. Embossed Harley-Davidson script logo. Sold as a set of two guards.

43000304 **\$106.95**
Fits '21-later RA1250 and RA1250S models.



D. REAR AXLE GUARDS

E. REAR BRAKE RESERVOIR GUARD

This compact and rugged aluminum guard is designed to help protect the Pan America 1250 model rear brake fluid reservoir from damage in a low-speed tip-over event, and from passing brush or flying gravel. Compact aluminum guard fits within motorcycle frame for outstanding protection with minimal weight and no interference while riding. Guard is secured to existing mount by a single M6 Allen bolt for quick and easy removal when maintenance is required. Designed specifically for Pan America 1250 models for a factory fit and installation with no drilling. Laser-etched Harley-Davidson script

49000248 **\$52.95**
Fits '21-later RA1250 and RA1250S models.



E. REAR BRAKE RESERVOIR GUARD



F. ADVENTURE JIFFY

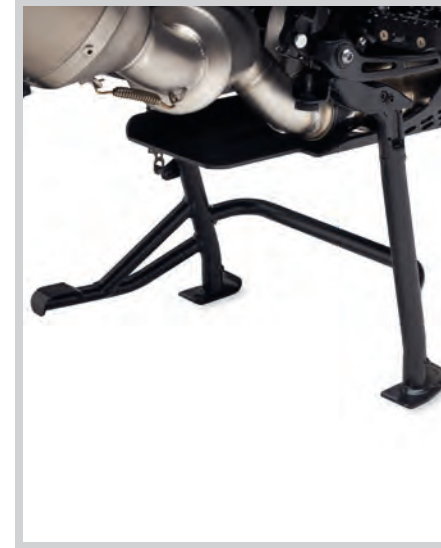

G. CENTER STAND



H. RADIATOR SHIELD



I. BRUSH GUARD



J. PAN AMERICA HAND WIND DEFLECTORS



K. HEADLAMP GUARD

PAN AMERICA® 21

Vehicle Protection

F. ADVENTURE JIFFY STAND FOR PAN AMERICA® 1250 MODELS

Heading off-road on a Harley-Davidson® Pan America® 1250 model? This Adventure Jiffy Stand offers added stability on soft surfaces and is an ideal factory fit. Jiffy stand features a 60% larger footprint compared to the Original Equipment jiffy stand for more-secure support when parking the motorcycle on soft ground. Does not alter the height of the jiffy stand to maintain original lean of bike when parked. Factory designed for easy installation, an ideal fit and maximum durability. Does not change lean angle when motorcycle is cornering.

50000248 **\$53.95**
Fits '21-later RA1250 and RA1250S models without Adaptive Ride Height.

50000264 **\$53.95**
Fits '21-later RA1250S models equipped with Adaptive Ride Height.

G. CENTER STAND

The Center Stand supports the parked motorcycle in an upright position. Raises the rear wheel off the ground for easier maintenance and tire changes. With the Center Stand deployed, the parked motorcycle takes up less space than it would leaning on its side stand. Pre-assembled with springs in place.

92900066 **\$294.95**
Fits '21-later RA1250 models. Original Equipment on RA1250S.

H. RADIATOR SHIELD

The mesh Radiator Shield attaches to the front of the radiator to protect it from small stones and other debris, especially when riding off road. The factory-integrated design of this shield ensures a perfect fit and easy installation, and its mesh adds rugged style to the bike.

57200258 **\$160.95**
Fits '21-later RA1250 and RA1250S models.

I. BRUSH GUARD*

Tackle tough off-road situations with confidence. The Brush Guard is designed to protect the radiator shroud and other components from damage due to passing brush along a trail, and in the case of a tip-over. Factory-integrated design ensures a perfect fit and easy installation. Rugged tubular steel construction and durable Satin Black finish matches motorcycle frame.

49000192 **\$319.95**
Fits '21-later RA1250 models. Original Equipment on RA1250S.

J. PAN AMERICA HAND WIND DEFLECTORS

Add protection from the elements. These lightweight Hand Wind Deflectors help keep wind, insects, small stones and small branches from impacting the rider's hands and provide added comfort in cool weather. Easy to install on Original Equipment mounting points.

55900297 **\$137.95**
Fits '21-later RA1250 models. Original Equipment on RA1250S.

K. HEADLAMP GUARD

Tackle tough off-road situations with confidence. The rugged mesh is designed to help protect the headlamp from impact damage and debris and adds rugged styling. The factory-integrated design ensures a perfect fit and easy installation. Does not degrade headlamp performance.

67700555A **\$104.95**
Fits '21-later RA1250 and RA1250S models.



***WARNING:** These guards may provide limited leg and cosmetic vehicle protection under unique circumstances (fall over while stopped, very low speed slide). They are not made nor intended to provide protection from bodily injury in a collision with another vehicle or any other object.

22 PAN AMERICA®

Luggage

PAN AMERICA® ALUMINUM LUGGAGE

All rugged aluminum luggage was created in collaboration with SW-MOTEC™ for on- and off-road travel. Each piece has been designed and tested with the motorcycle to ensure factory-quality fit, durability and reliability, without compromising motorcycle handling or lean angle. Both the cases and mounts have passed Harley-Davidson static tip-over tests. The anodized or painted finish is easy to clean and prevents oxidation. With a gasket in the lid, each piece is waterproof and passes a rigorous Harley-Davidson water-intrusion test. The cases each have integrated handles and bungee eyes, and a single key locks each case closed and locks the case to its mount.

A. PAN AMERICA ANODIZED ALUMINUM TOP CASE

Luggage volume capacity: 38 liters.
Luggage weight capacity is 10 kg (22 pounds).

53000814 Clear Anodized. **\$580.95**
Fits '21-later RA1250 and RA1250S models. Requires separate purchase of Top Case Mounting System P/N 53000800.

B. PAN AMERICA ANODIZED ALUMINUM SIDE CASES

Luggage volume capacity: Right case 37 liters, left case 45 liters. Luggage weight capacity is 10 kg (22 pounds) in each case.

90202082 Clear Anodized. **\$1,038.95**
Fits '21-later RA1250 and RA1250S models. Requires separate purchase of Side Case Mounting System P/N 90202087.

C. PAN AMERICA ANODIZED ALUMINUM TOP CASE – BLACK

Luggage volume capacity: 38 liters.
Luggage weight capacity is 10 kg (22 pounds).

53000816 Black. **\$580.95**
Fits '21-later RA1250 and RA1250S models. Requires separate purchase of Top Case Mounting System P/N 53000800.

D. PAN AMERICA ALUMINUM SIDE CASES – BLACK

Luggage volume capacity: Right case 37 liters, left case 45 liters. Luggage weight capacity is 10 kg (22 pounds) in each case.

90202088 Black. **\$1,038.95**
Fits '21-later RA1250 and RA1250S models. Requires separate purchase of Side Case Mounting System P/N 90202087.



A. PAN AMERICA ALUMINUM TOP CASE – CLEAR ANODIZED



B. PAN AMERICA ALUMINUM SIDE CASES – CLEAR ANODIZED



C. PAN AMERICA ALUMINUM TOP CASE – BLACK



D. PAN AMERICA ALUMINUM SIDE CASES – BLACK



E. PAN AMERICA SPORT DETACHABLE TOP CASE



F. PAN AMERICA SPORT SIDE CASES



G. PAN AMERICA SPORT TOP CASE LINERS



H. PAN AMERICA SPORT SIDE CASE LINERS

PAN AMERICA® 23

Luggage

PAN AMERICA® SPORT LUGGAGE

Designed primarily for on-road touring, Sport Luggage offers a smooth aesthetic and presents a clean silhouette on the motorcycle. Mounts are designed for easy installation and removal of the luggage and leave a clean look when the luggage is removed. With a gasket in the lid, each piece is waterproof and passes a rigorous Harley-Davidson water intrusion test. Each luggage piece has an integrated handle to make it easy to carry off the bike. Contains complete kit to key locks to vehicle ignition. See H-D.com and search for the bag part number for a How To video on keying the locks.

E. PAN AMERICA SPORT TOP CASE

The top case and its mount (sold separately) are designed to maximize loading capacity without compromising ride and handling. Luggage volume capacity: 36 liters. Luggage weight capacity is 10 kg (22 pounds).

Fits '21-later RA1250 and RA1250S models. Requires separate purchase of Top Case Mounting System P/N 53000800.

53000751 **\$534.95**

F. PAN AMERICA SPORT SIDE CASES

The mounts for left and right side cases are part of the motorcycle, so when the cases are removed there is no extra hardware left behind to clutter the styling. Luggage volume capacity: Right case 30 liters, left case 35 liters. Luggage weight capacity is 10 kg (22 pounds) in each case.

90201973 **\$875.95**
Fits '21-later RA1250 and RA1250S models.

G. PAN AMERICA SPORT TOP CASE LINERS

This water-resistant liner is designed to fit perfectly into the Sport Top Case. This liner features heavy-duty zippers, comfortable carrying handles and convenient D-rings for optional shoulder straps.

53000862 **\$55.95**
Fits '21-later RA1250 and RA1250S models. equipped with Sport Side Cases P/N 90201971.

H. PAN AMERICA SPORT SIDE CASE LINERS

Simplify packing and unpacking your motorcycle. These liners are designed to fit perfectly into Sport Side Cases. These bags feature heavy-duty zippers, comfortable carrying handles and D-rings for optional shoulder straps.

90202220 **\$107.95**
Fits '21-later RA1250 and RA1250S models. equipped with Sport Side Cases P/N 53000753.

24 PAN AMERICA®

Luggage

PAN AMERICA® ADVENTURE SOFT LUGGAGE

The Adventure Soft Luggage line is intended for the hard-core off-road rider. Designed specifically for motorcycle use, these durable bags resist damage if the bike tips over. The bag material is waterproof, exterior pockets have waterproof zippers, and the roll-top closure creates a weather-tight seal, so you can ride with confidence knowing that gear will stay dry no matter the conditions. The roll-top design and multiple compression straps make it possible to cinch the load tightly, and give this luggage flexible capacity. The bags are reflective to enhance their visibility in low light conditions. Includes universal mounting straps.

A. PAN AMERICA ADVENTURE SOFT SADDLEBAGS

Adventure Soft Saddlebags are supported by the Side Case Mounting System (sold separately). Luggage volume capacity is 25 liters in each bag. Weight capacity is 10 kg (22 pounds) in each bag. Sold as a set of two bags with mounting straps. Installation requires separate purchase of Side Case Mounting System P/N 90202087.

90202107 **\$518.95**

Fits '21-later RA1250 and RA1250S models. Requires separate purchase of Side Case Mounting System P/N 90202087.

B. PAN AMERICA ADVENTURE DUFFEL BAG

The Adventure Duffel Bag has extra-large volume capacity but can be compressed to match the volume of the contents and be as compact as possible. Duffel can be secured to the Top Case Mounting Plate (sold separately) behind the seat or on the passenger pillion in front of a hard case. Luggage volume capacity: 2,440 cubic inches (40 liters). Luggage weight capacity: 22 pounds (10 kg) P/N 90202087.

93300142 **\$175.95**

Fits '21-later RA1250 and RA1250S models.



A. PAN AMERICA ADVENTURE SOFT SADDLEBAGS



B. PAN AMERICA ADVENTURE DUFFEL BAG



C. PAN AMERICA TANK BAG



D. PAN AMERICA SIDE CASE MOUNTING SYSTEM



E. PAN AMERICA TOP CASE MOUNTING SYSTEM



F. PAN AMERICA PASSENGER BACKREST PAD



G. PREMIUM INDOOR/OUTDOOR COVER

PAN AMERICA® 25

Luggage

C. PAN AMERICA® TANK BAG

Keep essentials and a mobile device handy on the ride. Designed specifically for Pan America® 1250 and Pan America 1250 Special models, the bottom of this tank bag is co-molded to fit over the plastic cover on the top of the fuel tank for a secure, custom fit. Touch-sensitive window over the top pocket that enables function of a mobile device stored in the pocket. A water-resistant rain cover has a matching touch-sensitive window. A compartment designed to hold an auxiliary lithium battery is located below the device pocket, and has a port for a charging cable. The interior of the bag is high-visibility orange to make it easier to see contents. Side pockets are fleece-lined. Bag has a top carry-handle, pockets and dividers inside the bag. A leave-behind strap to secure bag can be tucked under the front of the motorcycle seat when bag is not in place. Luggage volume capacity is 8 liters. Weight capacity is 2 kg (5 pounds).

93300129 **\$263.95**

Fits '21-later RA1250 and RA1250S models.

D. PAN AMERICA SIDE CASE MOUNTING SYSTEM

Factory integrated design mates perfectly to mounted points on the motorcycle. Installing and adjusting the system is simple and does not require specialty tools. Built to demanding Harley-Davidson specifications to ensure gear is protected in the most-rugged conditions.

90202087 **\$329.95**

Fits '21-later RA1250 and RA1250S models.

E. PAN AMERICA TOP CASE MOUNTING SYSTEM

Required for installation of Aluminum Top Cases or Sport Top Case. Optimized load points ensure system is durable. Can also be used to support and secure Soft luggage.

53000800 **\$183.95**

Fits '21-later RA1250 and RA1250S models.

F. PAN AMERICA PASSENGER BACKREST PAD

Optimize passenger comfort when Aluminum Top Case is installed.

53000847 **\$100.95**

Fits '21-Later RA1250 and RA1250S models equipped with Aluminum Top Case P/Ns 53000814 or 53000816.

G. PREMIUM INDOOR/OUTDOOR COVER

This custom water-resistant motorcycle cover is an ideal fit for Pan America models and is adjustable to fit well with or without luggage installed on the bike. Durable materials and construction help protect the motorcycle from the elements when stored indoors or outdoors. Weather-shielded vents in the top of the cover promote air circulation to reduce moisture build-up and minimize corrosion. Integrated storage pouch with compression buckles permits convenient packing and conserves valuable luggage space. Reflective Bar & Shield logos make the motorcycle more visible in low light conditions. The cover skirt features front and rear adjustable drawstrings to cinch the cover and a belly strap to reduce ballooning in the wind. Convenient opening near the front wheel for a security chain or cable, and internal pocket that accepts the optional Cover Alarm (P/N 69000038, sold separately)

93100070 **\$186.95**

Fits RA1250 and RA1250S models.

26 PAN AMERICA®

Screamin' Eagle® Performance Parts

A. SCREAMIN' EAGLE® QUICKSHIFTER FOR PAN AMERICA® 1250 MODELS

Shift in an instant. The Screamin' Eagle® Quickshifter provides clutchless up and down shifts without risking transmissions damage. When foot shift control is engaged fuel and ignition are cut within milliseconds, which unloads the transmission allowing you to fly through up-shifts without touching the throttle or clutch. Shifter signal also blips the throttle for seamless down-shifts without using the clutch. Precise shifts are accomplished in an instant enabling smoother, stress-free control in on- and off-road situations. Installation requires a dealer Digital Technician™ update/flash.

32700151 **\$323.95**
Fits '22-later RA1250 and RA1250S models. Installation requires dealer Digital Technician update. Does not fit California models.

B. SCREAMIN' EAGLE® STREET CANNON MUFFLER – PAN AMERICA

Realize a significant weight reduction and a deep, sporty exhaust tone with this Screamin' Eagle® Street Cannon muffler, designed specifically to fit right and look great on Pan America® 1250 and Pan America 1250 Special models. Weighs 42 percent less than the Original Equipment muffler. Durable construction includes a titanium shell, carbon fiber end cap and a stainless-steel mid-pipe. The deep and sporty exhaust note is stirring but not extreme. Engineered with the motorcycle for easy installation and seamless fit.

65600389 Titanium. **\$983.95**
Fits '21-later RA1250 and RA1250S models. California models instead require P/N 65600449. Does not fit California models.

C. SCREAMIN' EAGLE AIR FILTERS

1. SCREAMIN' EAGLE® HIGH-FLOW AIR FILTER – ROUND

This washable and reusable filter is a direct replacement for the original equipment filter and provides the same air flow performance as the original equipment.

29400428 **\$74.95**
Fits '21-later RA1250, RA1250S and RH1250S models.
29400449 **\$78.95**
Fits '21 California RA1250 and RA1250S models.

2. SCREAMIN' EAGLE® HIGH-FLOW AIR FILTER – HOMEPLATE

This washable and reusable filter provides 5 percent more air flow to the engine compared to the original equipment filter.

29400426 **\$84.95**
Fits '21-later RA1250, RA1250S and RH1250S models.
29400450 **\$89.95**
Fits '21 California RA1250, RA1250S and RH1250S models.

3. SCREAMIN' EAGLE® EXTREME-FLOW AIR FILTER – PAN AMERICA

This washable and reusable filter is specifically designed for off-road environments with off-road specific filter media. Provides 9 percent more air flow to the engine compared to the original equipment filter to allow the engine to breathe in all types of riding conditions. Clean, dry, and re-oil to reuse

29400427 **\$127.95**
Fits '21-later RA1250 and RA1250S models.
29400451 **\$111.95**
Fits '21 California RA1250 and RA1250S models.

Harley-Davidson® motorcycles modified with some Screamin' Eagle® Performance products must not be used on public roads and, in some cases, may be restricted to closed-course competition. These performance parts are 49-state U.S. EPA compliant but are NOT compliant for sale or use in California on pollution-controlled motor vehicles. California guidelines on tampering can also lead to substantial fines and penalties. Screamin' Eagle® Performance products are intended for the experienced rider only.



A. SCREAMIN' EAGLE QUICKSHIFTER FOR PAN AMERICA 1250 MODELS



B. SCREAMIN' EAGLE STREET CANNON MUFFLER – PAN AMERICA

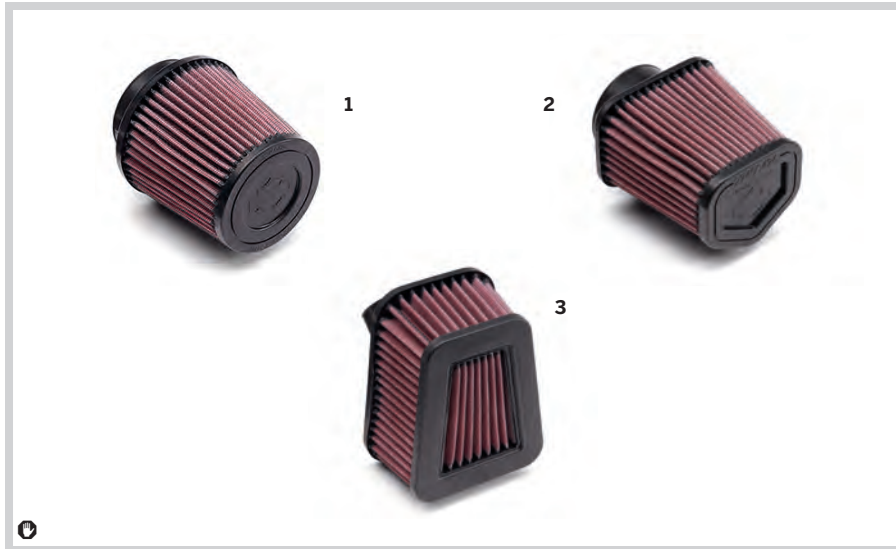

C. SCREAMIN' EAGLE AIR FILTERS



D. CARBON FIBER EXHAUST SHIELD INSERT



F. OFFROAD ADJUSTABLE BRAKE LEVER KIT



H. 80GRIT RIDER FOOTPEGS



E. PAN AMERICA ROUND STYLE LOCKING FUEL CAP



G. OFFROAD FOLDING AND ADJUSTABLE SHIFT LEVER KIT



I. 80GRIT SHIFTER PEG – BLACK

PAN AMERICA® 27

Accessories

D. CARBON FIBER EXHAUST SHIELD INSERT

The lightweight carbon fiber exhaust shield helps keep heat away from the rider's leg while adding a touch of style to the exhaust shield. Hand-laid carbon fiber construction is extremely light weight and strong. Designed for easy installation over the existing exhaust shield. Reflective heat shielding material bonded to the backside of the insert. Adds a style element to complement the Screamin' Eagle® Street Cannon exhaust system.

65400648 **\$64.95**
Fits '21-later RA1250 and RA1250S models.

E. PAN AMERICA® ROUND STYLE LOCKING FUEL CAP

Secure and safeguard your fuel supply. This locking fuel cap was designed and tested by Harley-Davidson specifically for Pan America models. Key slot is hidden from view and protected from the elements by a swing-away cover that features Bar & Shield logo. Includes parts and instructions to match the locking cylinder to your factory key set.

61100188 **\$129.95**
Fits '21-later RA1250 and RA1250S models.

F. OFFROAD ADJUSTABLE BRAKE LEVER KIT

Change controls with conditions. Adjustable trailside without tools for ideal comfort and control when riding in a seated or standing position. The rear brake lever adjusts upwards higher than the OE position for comfort when riding while standing. No tools required for adjustment. Durable black finish.

41600371 Black. **\$224.95**
Fits '21-later RA1250 and RA1250S models.

G. OFFROAD FOLDING AND ADJUSTABLE SHIFT LEVER KIT.

Change controls with conditions. Adjustable trailside for ideal comfort and control when riding in a seated or standing position or for rider preference. The footpeg position is adjustable on the lever for quick and easy position change. Adjustment changes shifter peg distance (fore/aft) relative to the footpeg. The footpeg folds away to prevent damage in a low-speed tip-over event. Durable black finish.

33600401 Black. **\$189.95**
Fits '21-later RA1250 and RA1250S models.

H. 80GRIT™ RIDER FOOTPEGS

The rugged 80GRIT™ Collection foot controls combine form and function with the feel of an old-school BMX-style footpeg.

Fits rider position on '21-later RA1250 and RA1250S models.
50501383 Black. **\$191.95**
50501390 Raw. **\$191.95**

I. 80GRIT™ SHIFTER PEG

The rugged 80GRIT™ Collection foot controls combine form and function with the feel of an old-school BMX-style footpeg. Aluminum material with rugged styled edges, which complement the styling of the footpegs.

33600306 Black. **\$54.95**
Fits '21-later RA1250 and RA1250S models.

28 PAN AMERICA®

Wheels

A. LACED WHEELS

This laced wheel is as rugged as it looks. A new design has an aluminum rim and carbon steel with zinc plated spokes. The spokes are inserted through the aluminum wheel rim outside of the tire bead. An ideal wheel set for serious off-road adventure riding. Anodized matte black rim and gloss black acrylic e-coat hub. Strong, durable design intended for challenging off-road duty with no compromise of on-road performance. Design permits the use of a tubeless tire, which eliminates the weight of an inner tube. Spokes are repairable in the field without removing the wheel from the motorcycle.

43300821 19" Front. **\$820.95**
Fits '21-later RA1250 and RA1250S models. Requires separate purchase of (qty 2) Front Brake Rotors P/N 41500195, (qty 10) Brake Rotor Hardware P/N 41500020 and Wheel Installation Kit P/N 42400038.

40900814 17" Rear. **\$874.95**
Fits '21-later RA1250 and RA1250S models. Requires separate purchase of Wheel Installation Kit P/N 42400039.

B. WHEEL INSTALLATION KIT (ABS) – FRONT

Enables installation of front Laced wheel

42400038 **\$84.95**
Fits '21-later RA1250 and RA1250S models.

WHEEL INSTALLATION KIT (ABS) – REAR

Enables installation of rear Laced wheel.

42400039 **\$84.95**
Fits '21-later RA1250 and RA1250S models.

C. MOTORCYCLE TIRE PRESSURE MONITORING SYSTEM

The Harley-Davidson® Tire Pressure Monitoring System (TPMS) displays current front and rear tire pressure on the on the display screen and displays an indicator to alert the rider when tire pressure is low, and the pressure should be checked.

Fits '21-later Pan America® models (except Japan) equipped with laced wheels.

42300150 **\$213.95**

Fits '20-later Touring and '21-later Pan America (except Japan) with cast Original Equipment or Accessory wheels that accept a TPMS sensor.

42300124A **\$213.95**

D. HARLEY-DAVIDSON® TOOL KIT – PAN AMERICA®

A tool kit designed specifically for Pan America 1250 models. Provides tools necessary for external service and maintenance of your vehicle.

Kit Includes:

- 6" long nose locking pliers with wire cutter. Curved jaw line-man pliers with wire cutter
- L-handle 1/4" square drive, 1/4" square to 1/4" hex adaptor, 1/4" 8mm square drive
- 32mm flat wrench, 36mm/22mm flat wrench
- 14mm spark plug wrench, 6" adjustable wrench
- 22mm X 2cm hex large
- 1/4" hex drive bits: T25, T27, T30, T40, T45, T50, 4mm, 5mm, 6mm, with 9-bit holder
- 5 ft. length of 1.6mm safety wire, Duct tape roll 48-75mm width X 2 meters, Zip ties: (5) 6" long and (5) 12" long
- 2 tool handle extensions and tool pouch

14900127 **\$160.95**
For use with '21-later Revolution® Max models.



A. LACED WHEEL – 19" FRONT



B. WHEEL INSTALLATION KIT (ABS)



C. MOTORCYCLE TIRE PRESSURE MONITORING SYSTEM



D. HARLEY-DAVIDSON TOOL KIT – PAN AMERICA



E. MICHELIN ANAKEE WILD OFF-ROAD FRONT TIRE



E. MICHELIN ANAKEE WILD OFF-ROAD REAR TIRE



F. GENUINE HARLEY-DAVIDSON OIL FILTER – BLACK



G. PAN AMERICA ENDCAP STYLE FILTER WRENCH



H. H-D GENUINE SYN BLEND MOTORCYCLE OIL



I. HARLEY-DAVIDSON ORIGINAL EQUIPMENT SPARK PLUGS



J. SCREAMIN' EAGLE PERFORMANCE SPARK PLUGS

REVOLUTION® MAX 29

Accessories

E. MICHELIN® ANAKEE WILD OFF-ROAD TIRES

All-new compounds, combined with an innovative tread pattern inspired by Dakar winning MICHELIN® Desert Race® tire, offering extraordinary longevity for extended adventure On/Off-road traction, handling, and precise steering thanks to an innovative tread pattern. The alignment of the scoop-shaped, staggered tread blocks offer traction on soft terrain and in all conditions. Resistant to damage and high temperatures due to optimized tread depth and a new compound. Excellent longevity. These tires may be installed on the Original Equipment cast aluminum or laced wheels

*Tires requires the purchase of a Digital Technician™ update completed by a Harley-Davidson® dealer.

Michelin® Anakee Wild Off-Road Front Tire

Fits '21-later RA1250 and RA1250S models.

43100049 120/70R19. **\$249.95**

Michelin® Anakee Wild Off-Road Rear Tire

Fits '21-later RA1250 and RA1250S models.

43200050 170/60R17. **\$329.95**

F. GENUINE HARLEY-DAVIDSON® OIL FILTER – BLACK

Trust the fit and performance. This Harley-Davidson® oil filter is the same Original Equipment filter that is installed at the factory. Designed and quality-tested for the Revolution® Max 1250 engine.

62700280 Spin On **\$14.95**
Fits '21-later Revolution Max engine equipped models.

G. PAN AMERICA® ENDCAP STYLE FILTER WRENCH

14900138 Spin On **\$16.95**
Fits '21-later Revolution Max engine equipped models.

H. H-D™ GENUINE SYN BLEND MOTORCYCLE OIL

Genuine SYN Blend Motorcycle Oil is a formulation engineered by Harley-Davidson and factory tested for optimal performance. This oil blends premium base stocks with premium Harley-Davidson proprietary additives for:

- Optimized durability.
- Minimal friction loss.
- Wide ambient operating temperature.
- Superior durability for engine components over a wide operating range and temperature.

Supports tighter engine tolerances in colder temperatures. Formulated for optimal clutch, engine, and transmission performance. Facilitates long life of emission components, including exhaust catalysts.

Fits '21-later Revolution Max engine equipped models.

62600099 Quart, US **\$13.95**

62600102 Quart, AP **\$13.95**

62600100 Litre, Can **\$13.95**

62600101 Litre, EMEA/LA **\$13.95**

I. HARLEY-DAVIDSON® ORIGINAL EQUIPMENT SPARK PLUGS

Stock replacement spark plugs.

31600190 **\$10.95**
Fits '21-later Revolution Max engine equipped models.

J. SCREAMIN' EAGLE® PERFORMANCE SPARK PLUGS

For Standard Compression Applications. Ribbed Core Technology (RCT) provides resistance to plug fouling. Designed with Original Equipment-style noise suppression to limit electrical interference with radios and communication equipment. Plated Jacket helps prevent corrosion in harsh weather and temperature conditions. Unique style with Screamin' Eagle logo. Sold in pairs

31600180 **\$32.95**
Fits '21-later Revolution Max engine equipped models.

30 REVOLUTION® MAX

Windshields

A. QUICK-RELEASE TOURING WINDSHIELD – CLEAR

Wind deflection with sporty style. This detachable windshield is designed specifically for the Nightster® model and can be installed or removed quickly and easily for desired style and protection. 17" clear windshield deflects wind flow over the head of most riders to reduce wind force on the helmet and chest to reduce fatigue on long highway rides. Offers added rider protection from wind, rain and insects. Mounts to the forks with quick-release clamps so there is no leave-behind hardware when the windshield is removed. Black mounting hardware and support brackets match the style of the Nightster model. Harley-Davidson quality hard-coated polycarbonate material resists chips and scratching. Includes all necessary mounting hardware

57400479 \$449.95
Fits '22-later RH975 and RH975S models.

B. QUICK-RELEASE COMPACT WINDSHIELD – LIGHT SMOKE

Wind deflection with sporty style. This detachable windshield is designed specifically for the Nightster model and can be installed or removed quickly and easily for desired style and protection. 11" smoked windshield maintains consistent wind flow at shoulders and above for improved comfort and added protection from the elements. Light Smoke tint and compact design enhances the look of the bike. Mounts to the forks with quick-release clamps so there is no leave-behind hardware when the windshield is removed. Black mounting hardware and support brackets match the style of the Nightster model. Harley-Davidson quality hard-coated polycarbonate material resists chips and scratching. Includes all necessary mounting hardware

57400492 \$429.95
Fits '22-later RH975 and RH975S models.



A. QUICK-RELEASE TOURING WINDSHIELD – CLEAR



B. QUICK-RELEASE COMPACT WINDSHIELD – LIGHT SMOKE



C. QUICK-RELEASE COMPACT WINDSHIELD – DARK SMOKE



D. ENGINE GUARD – GLOSS BLACK

REVOLUTION® MAX 31

Windshield & Engine Guards

C. QUICK-RELEASE COMPACT WINDSHIELD

Wind deflection with sporty style. This detachable windshield is designed specifically for the Sportster® S model and can be installed or removed quickly and easily for desired style and protection. Shaped to maintain wind flow at shoulders and above for improved comfort or added protection from the elements while maintaining airflow. Mounts to the forks with quick-release clamps. Black mounting hardware and support brackets and dark windshield tint match the style of the Sportster® S model. Harley-Davidson quality hard-coated polycarbonate material resists chips and scratching. Includes all necessary mounting hardware.

57400459 Dark Smoke. \$417.95
Fits '21-later RH1250S models.

D. ENGINE GUARD*

The strength of steel. This tubular steel engine guard is designed to help protect the Sportster® S motorcycle from cosmetic damage in the event of a stationary or low-speed tip-over. Strong one-piece tubular steel guard. Black finish matches the motorcycle chassis. Bolts onto existing mounting points for clean style and easy installation with no modifications. Includes all necessary mounting hardware.

49000194 Gloss Black. \$263.95
Fits '21-later RH1250S models.

REVOLUTION MAX

Notice: The prices appearing in this catalog are the manufacturer's suggested retail prices. Actual retail prices may vary.

***WARNING:** Engine guards may provide limited leg and cosmetic vehicle protection under unique circumstances (fall over while stopped, very low speed slide). They are not made nor intended to provide protection from bodily injury in a collision with another vehicle or any other object.

Notice: The prices appearing in this catalog are the manufacturer's suggested retail prices. Actual retail prices may vary.

32 REVOLUTION® MAX

Seats

A. SUNDOWNER™ SOLO RIDER SEAT

Maximize your miles. The Sundowner™ Solo Seat for the Harley-Davidson® Nightster® model can help keep you comfortable and alert until the next gas stop. Its enhanced bucket shape and spherical-void foam construction is designed to reduce numbing pressure points, and waterproof construction means you won't have a soggy bum after the rain quits. Enhanced bucket design cradles the rider and minimizes pressure points for improved long-haul comfort.

Waterproof construction and seam sealed stitch lines prevent water from soaking into the foam and leaving the rider with a damp bum. Factory fit retains access to fuel fill and under-seat features. Easy installation.

52000571 **\$277.95**
Fits '22-later RH975 models.



A. SUNDOWNER™ SOLO RIDER SEAT

B. SUNDOWNER™ PASSENGER PILLION

Share the ride and the comfort. Designed for the Nightster model, the Sundowner™ pillion is wider and longer than a standard accessory pillion for more miles of comfort. Designed to match the styling of the Sundowner™ Solo Rider Seat. Waterproof construction and seam sealed stitch lines prevent water from soaking into the foam and leaving the passenger with a damp bum. Uses factory mounting points for clean-and-easy installation and removal. Cover and stitching matches the Sundowner Solo Seat to maintain integrated motorcycle style. Includes all necessary mounting hardware.

52400288 **\$170.95**
Fits '22-later RH975 models equipped with Original Equipment or Sundowner solo seat. Installation requires separate purchase of Passenger Footpeg Mount and Peg Kit P/N 50502434.



B. SUNDOWNER™ PASSENGER PILLION

C. REACH® SOLO SEAT

This seat is shaped to deliver the ergonomic position that a shorter rider needs for optimal comfort and control, while maintaining premium style. Places the rider a 0.5" (13mm) forward and 0.3" (8mm) lower when compared to the stock Nightster model seat. Heavily sculpted nose and inner thigh area greatly improves reach to ground and removes inner thigh pressure for shorter riders. Low overall height provides the rider with added confidence and control while the bike is at a stop or during parking maneuvers. Seat maintains style and fit of the stock seat for a great look. Seat width 12.8"

52000550 **\$249.95**
Fits '22-later RH975 models.



C. REACH® SOLO SEAT

D. PASSENGER PILLION

Share the ride and the fun. Designed for the Nightster® model, the pillion is secured to the tail section behind the solo seat. Uses factory mounting points for clean-and-easy installation and removal. Quality vinyl cover maintains integrated motorcycle style. Includes all necessary mounting hardware.

52400306 **\$139.95**
Fits '22-later RH975 models equipped with Original Equipment solo seat. Installation requires separate purchase of Passenger Footpeg Mount and Peg Kit P/N 50502434.



D. PASSENGER PILLION



E. SUNDOWNER SOLO SEAT – SPORTSTER S MODEL



F. SUNDOWNER PASSENGER PILLION



G. PASSENGER PILLION



H. PASSENGER BACKREST KIT

REVOLUTION® MAX 33

Seats

E. SUNDOWNER™ SOLO SEAT – SPORTSTER® S MODEL

Head for the horizon. This Sundowner™ Seat provides the Sportster® S rider with maximum comfort for long rides. Enhanced bucket design and spherical-void foam construction for improved long-haul comfort. Extra support for more-aggressive riding. Seam sealed stitch lines prevent water from soaking into the foam and leaving the rider with a damp bum. Details in the top seat cover enhance overall style.

52000510 **\$288.95**
Fits '21-later RH1250S models.

F. SUNDOWNER PASSENGER PILLION

Share the ride and the fun. Designed for the Sportster S model, the pillion is secured to the tail section behind the solo seat. Pillion upholstery detail matches the accessory Sundowner Solo Seat P/N 52000510 (sold separately) for an integrated look and fit on the motorcycle. Slightly larger width than the standard accessory pillion for added passenger comfort. Seam sealed stitch lines prevent water from soaking into the foam and leaving the passenger with a damp bum. Kit includes a rear fender extension designed to deflect spray or debris from the passenger's back. The pillion also provides a solid base for accessory Tail Bag luggage P/N 93300128 (sold separately). Includes all necessary mounting hardware.

52400251 **\$189.95**
Fits '21-later RH1250S models equipped with Sundowner Solo Seat P/N 52000510. Installation requires separate purchase of Passenger Footpeg Mount Kit P/N 50502192 and passenger footpegs.

G. PASSENGER PILLION

Share the ride and the fun. Designed for the Sportster S model, the pillion is secured to the tail section behind the solo seat. Pillion upholstery matches the Original Equipment rider seat for an integrated look and fit on the motorcycle. Kit includes a rear fender extension designed to deflect spray or debris from the passenger's back. The pillion also provides a solid base for accessory Tail Bag P/N 93300128 (sold separately). Includes all necessary mounting hardware.

52400271 **\$168.95**
Fits '21-later RH1250S models equipped with Original Equipment solo seat. Installation requires separate purchase of Passenger Footpeg Mount Kit P/N 50502192 and passenger footpegs.

H. PASSENGER BACKREST KIT

This low padded backrest slides into position on Passenger Pillion Kit P/N 52400271 or 52400251 (sold separately) and is secured to the tail section to provide ideal passenger confidence and comfort. Integrated design with the Sportster® S model for easy installation and removal. Pad matches the upholstery of the Original Equipment seat for an integrated look. The backrest is not designed to support luggage. Includes required mounting hardware.

52300715 **\$209.95**
Fits '21-later RH1250S models. Requires separate purchase of Passenger Pillion Kit P/N 52400271.

34 REVOLUTION® MAX

Backrests & Racks

A. HOLDFAST™ SISSY BAR UPRIGHT – LOW HEIGHT – GLOSS BLACK

A sissy bar and passenger backrest pad is the starting point for building a complete touring machine. The backrest adds long-range comfort and support and provides a feeling of confidence and control for the passenger. HoldFast™ One-Piece Uprights feature an exclusive latch system that permits the backrest to be installed or removed in seconds to add versatility to your ride. The HoldFast sissy bar upright simply slips into position on the docking points, and the fingertip latches are clicked into position for a positive lock. Gloss Black Finish. An ideal location to secure cargo. Improves passenger comfort and confidence. Available in short and standard height for optimized passenger back support. Works with Compact Passenger Backrest Pads (sold separately).

52300702 **\$199.95**
Fits '22-later RH975 and RH975S models.



A. HOLDFAST™ SISSY BAR UPRIGHT – LOW HEIGHT – GLOSS BLACK



B. HOLDFAST™ SISSY BAR UPRIGHT – STANDARD HEIGHT – GLOSS BLACK

B. HOLDFAST™ SISSY BAR UPRIGHT – STANDARD HEIGHT – GLOSS BLACK

A sissy bar and passenger backrest pad is the starting point for building a complete touring machine. The backrest adds long-range comfort and support and provides a feeling of confidence and control for the passenger. HoldFast™ One-Piece Uprights feature an exclusive latch system that permits the backrest to be installed or removed in seconds to add versatility to your ride. The HoldFast™ sissy bar upright simply slips into position on the docking points, and the fingertip latches are clicked into position for a positive lock. Gloss Black Finish. An ideal location to secure cargo. Improves passenger comfort and confidence. Available in short and standard height for optimized passenger back support. Works with Compact Passenger Backrest Pads (sold separately).

52300700 **\$199.95**
Fits '22-later RH975 and RH975S models.



A. HOLDFAST™ SISSY BAR UPRIGHT – LOW HEIGHT – GLOSS BLACK



B. HOLDFAST™ SISSY BAR UPRIGHT – STANDARD HEIGHT – GLOSS BLACK

C. LUGGAGE RACK FOR HOLDFAST™ SISSYBAR UPRIGHT – GLOSS BLACK

Smooth sweeping curves and gloss black finish defines the look of this Sport Luggage Rack. Designed to complement both short and standard-height HoldFast™ Sissy Bar Uprights, this sleek rack adds a practical and stylish touch to the motorcycle. Gloss Black Finish. Practical, stylish and convenient for packing. For use with short or standard-height HoldFast Sissy Bar Uprights. When bolted to the HoldFast™ Sissy Bar system makes for combined backrest and luggage rack. Can be installed or removed from the bike in seconds for a truly versatile touring or cruising machine.

50300292 **\$149.95**
Fits '22-later RH975 and RH975S models.



C. LUGGAGE RACK FOR HOLDFAST™ SISSYBAR UPRIGHT – GLOSS BLACK

D. HOLDFAST™ DOCKING HARDWARE KIT

The ideal choice for maximum versatility, this complete kit contains the docking hardware necessary to install all HoldFast™ detachable accessory options. Even if you only install a passenger backrest today, this kit allows you to add additional accessories in the future. Gloss Black Finish. Allows the addition of accessories as your customizing demands change. Includes docking points to allow installation of H-D® Detachables™ Sissy Bar and Solo Luggage Rack. This kit has been tested and validated to the rigorous standards required from the Harley-Davidson brand of premium products.

52300705 **\$44.95**
Fits '22-later RH975 and RH975S models..



D. HOLDFAST™ DOCKING HARDWARE KIT



E. DETACHABLE SADDLEBAGS

REVOLUTION® MAX 35

Luggage

E. DETACHABLE SADDLEBAGS

Optimize your Nightster® model with next generation of stylish, versatile and easy-to-use saddlebags from Harley-Davidson. Handle-mounted locks secure luggage lids and prevent access to the attachment mechanism to reduce the chance of theft. Fast and easy to mount and remove with a positive "click" to when the luggage is secured to the mounts. Ride with confidence in the wet weather thanks to advanced water sealing that keep luggage content dry. Size and shape of luggage is optimized for the Nightster model to deliver maximum capacity without affecting comfort or the installation of other accessories. Nightster™ models require separate purchase of Turn Signal Relocation Kit 67801297

90202254 **\$774.95**
Fits '22-later RH975 models. Requires separate purchase of Turn Signal Relocation Kit P/N 67801297.

Shown with:

TURN SIGNAL RELOCATION KIT

Provides third mounting point for Detachable Saddlebags (P/N 90202254, sold separately). Required to ensure proper attachment and functionality of the bags. Ensures compliance for license plate and turn signal visibility

67801297 **\$159.95**
Fits '22-later RH975 models.

F. TAIL BAG – SPORTSTER® S MODEL

This expandable Tail Bag luggage is designed to fit and look great on the Sportster® S model, and provides a convenient luggage option for ride essentials that is easy to install and remove. The Tail Bag is secured to the motorcycle tail section with quick-release straps and cam-lock buckles. The bag interior is bright orange to make it easier to see the contents. A carry handle makes it easy to move from bike to home or office. Includes waterproof rain cover. Luggage capacity is 5 pounds. The main compartment volume is expandable from 8.2 liters to 11.5 liters. Requires the Tail Bag be installed over the accessory Passenger Pillion Kit P/N 52400271 or 52400251 (sold separately).

93300128 **\$205.95**
Fits '21-later RH1250S models. Requires separate purchase of accessory passenger pillion for installation.

G. SINGLE-SIDED SWINGARM BAG – CLASSIC

Room for essentials with classic style, the Single-Sided Swingarm Bag is updated with modern design. Bag secures to left-side swingarm with easy-to-use straps and a semi-rigid back. Large enough to hold riding essentials you can't carry in a pocket, including most medium sized bottles. The detachable backwall organizer makes pre-packing the bag easy without having to squat or bend down to the bag. A waterproof removable liner helps keep contents dry. Engineered to not affect motorcycle lean angle. The black leather shell has a classic look that gains patina with age. Bag support required for installation.

90202530
Fits '21-later RH1250S and '22-later RH975 and RH975S models. RH1250S models require separate purchase of bracket P/N 90202533. RH975 models require separate purchase of bracket P/N 90202532

H. SINGLE-SIDED SWINGARM BAG – MODERN

Room for essentials with classic style, the Single-Sided Swingarm Bag is updated with modern design. Bag secures to left-side swingarm with easy-to-use straps and a semi-rigid back. Large enough to hold riding essentials you can't carry in a pocket, including most medium sized bottles. The detachable backwall organizer makes pre-packing the bag easy without having to squat or bend down to the bag. A waterproof removable liner helps keep contents dry. Engineered to not affect motorcycle lean angle. The black nylon shell is durable and fade-resistant. Bag support required for installation.

90202531 **\$199.95**
Fits '21-later RH1250S and '22-later RH975 and RH975S models. RH1250S models require separate purchase of bracket P/N 90202533. RH975 models require separate purchase of bracket P/N 90202532.



F. TAIL BAG – SPORTSTER S MODEL



G. SINGLE-SIDED SWINGARM BAGS – CLASSIC



H. SINGLE-SIDED SWINGARM BAGS – MODERN

Notice: The prices appearing in this catalog are the manufacturer's suggested retail prices. Actual retail prices may vary.

36 REVOLUTION® MAX

Foot Controls

A. FORWARD CONTROL KIT – GLOSS BLACK

Stretch out for maximum comfort and style. Gloss Black finish Moves the controls 10.2" (259mm) forward and 1.6" (40mm) upward from the Original Equipment foot position, providing a comfortable riding position. Does not compromise motorcycle lean angle. Ideal for taller riders or those that like to stretch out when hitting the open road. Includes all components necessary to convert your mid-controls to forward controls.

50502205 \$599.95

Fits '22-later RH975S models not equipped with engine guards.

B. CHIN GUARD

Replacement Chin Guard offers factory mounting locations and updated design to accommodate pass through of accessory forward foot controls or engine guard. Original Equipment mounting locations for easy bolt-on installation. No cutting or other modification required for a factory finish out of the box.

57200347 \$39.95

Fits '22-later RH975S models.

C. MID-CONTROL KIT

Move your feet. This complete mid-control conversion kit puts the Sportster® S motorcycle rider in a more-aggressive foot position for enhanced comfort and cornering confidence. It also reduces the reach to foot controls, an ergonomic advantage for riders of shorter stature. Relocates the left and right rider foot pegs and foot controls from the Original Equipment forward position to a mid-position on the bike. Installation does not compromise motorcycle lean angle. Mid-controls may be installed with passenger footpegs. Factory design ensures ideal fit and function. Includes all necessary mounting components and hardware.

50502136 \$693.95

Fits '21-later RH1250S models.

D. BLACK SHIFT LINKAGES

Complete a custom look when installing black accessory foot controls. Direct replacement for Original Equipment linkage ensures proper fit and performance. Durable black finish.

33600402 \$99.95

Fits '21-Later RH1250S models with original equipment forward controls.



A. FORWARD CONTROL KIT – GLOSS BLACK



B. CHIN GUARD



C. MID-CONTROL KIT



D. BLACK SHIFT LINKAGES



E. WILD ONE COLLECTION – REAR BRAKE LEVER

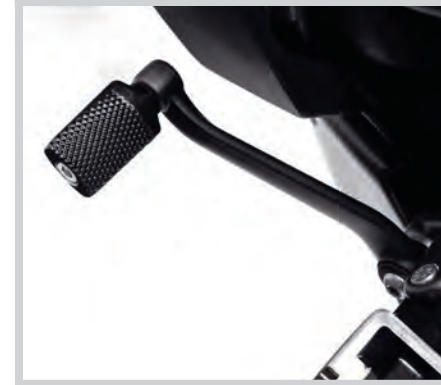

F. WILD ONE COLLECTION – SHIFTER PEG



G. '66 COLLECTION – REAR BRAKE LEVER



G. '66 COLLECTION – REAR BRAKE LEVER



H. PASSENGER FOOTPEG MOUNT KIT
(SHOWN WITH PASSENGER FOOTPEG P/N 50502026)



I. PASSENGER FOOTPEG MOUNT & PEG KIT



I. PASSENGER FOOTPEG MOUNT & PEG KIT

REVOLUTION® MAX 37

Foot Controls

E. WILD ONE™ COLLECTION – REAR BRAKE LEVER

Machined aluminum highlights. Complete this custom look with additional accessories from the Wild One™ Collection.

41600326 \$104.95

Fits '21-later RH1250S models.

F. WILD ONE COLLECTION – SHIFTER PEG

Machined aluminum highlights. Complete this custom look with additional accessories from the Wild One Collection.

33600338 \$53.95

Fits '21-later Revolution Max engine-equipped models.

G. '66 COLLECTION – REAR BRAKE LEVER

Durable satin black finish. Complete this custom look with additional accessories from the '66 Collection.

41600370 \$99.95

Fits '22-later RH975 models. Requires separate purchase of Brake Pedal Pad P/N 50600483.

41600348 \$99.95

Fits '21-later RH1250S models. Requires separate purchase of Brake Pedal Pad P/N 50600483.

H. PASSENGER FOOTPEG MOUNT KIT

Share the ride and the fun with passenger footpegs for the Sportster® S motorcycle. The foot peg mounts match the look of the motorcycle and bolt directly to integrated mounting points on the bike, for an easy clean-looking installation. Kit includes black left and right foot peg supports and mounting hardware. Footpegs and foot peg hardware sold separately.

50502192A \$232.95

Fits '21-later RH1250S models. Separate purchase of Passenger Footpegs is required

I. PASSENGER FOOTPEG MOUNT & PEG KIT

Share the ride and the fun with passenger footpegs for the Nightster® motorcycle. The footpeg mounts match the look of the motorcycle and bolt directly to integrated mounting points on the bike, for an easy, clean-looking installation. Kit includes black left and right footpeg supports, mounting hardware and footpegs. Easy to install

50502434 \$274.95

Fits '22-later RH975 and '23-later RH975S models.

38 REVOLUTION® MAX

Mirrors & Handlebars

A. EMPIRE™ COLLECTION – MIRRORS

Fits '21-later Revolution® Max engine-equipped models. RH975 and RH1250S models require separate purchase of Handlebar End Cap P/N 55801095, 55900246, 55900247 or 55900248.

56000220	Black Anodized.	\$234.95
56000221	Black Machine Cut.	\$244.95



A. EMPIRE™ COLLECTION MIRRORS – BLACK



A. EMPIRE™ COLLECTION MIRRORS – BLACK MACHINE CUT

B. ADVERSARY COLLECTION MIRRORS

Fits '21-later Revolution® Max engine-equipped models. RH975 and RH1250S models require separate purchase of Handlebar End Cap P/N 55801095, 55900246, 55900247 or 55900248.

56000224	Black w/ Orange Highlights.	\$219.95
56000225	Graphite w/ Machined Highlights.	\$199.95



B. ADVERSARY COLLECTION MIRRORS

C. '66 COLLECTION MIRRORS

D. REACH® HANDLEBAR

With a shape designed to place the handlebars closer to the rider, this Reach® Handlebar puts the rider in an upright seating position for added comfort and control. Designed to place the handlebars closer to the rider for ideal fit, comfort and control. Nightster® models require separate purchase of Brake Line P/N 41800874. Gloss Black finish 1" bar diameter.

55801263		\$99.95
Fits '21-later RH1250S and '22-later RH975 models.		



D. REACH® HANDLEBAR

E. TRACKER HANDLEBAR

Inspired by rough-and-tumble flat track race bikes, this handlebar is wider and taller than stock and features a cross brace. Designed to give the Sportster® S and Nightster models additional leverage during spirited riding. Fixed cross-bar gives aggressive look to front end. Nightster models require separate purchase of Brake Line P/N 41800874. Gloss Black finish

55801280		\$149.95
Fits '21-later RH1250S '22-later RH975 models.		

For additional Collections that fit Sport models, see the Engine Trim and Controls sections of this catalog.



E. TRACKER HANDLEBAR



F. CHROME EXHAUST SHIELDS



G. HEAVY BREATHER AIR CLEANER – CHROME



G. HEAVY BREATHER AIR CLEANER – BLACK

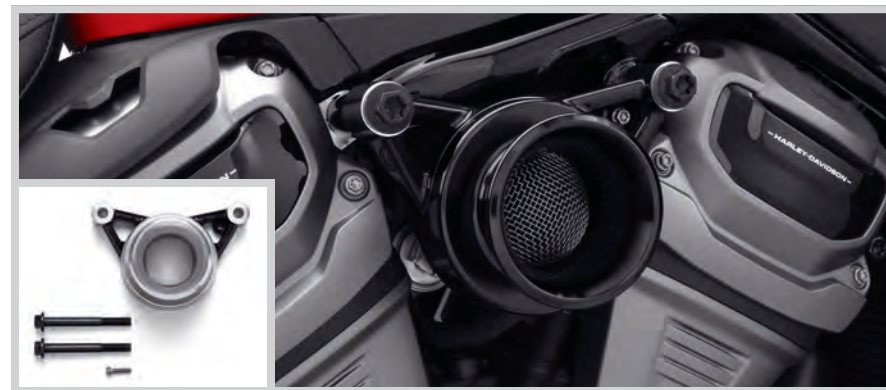

H. VELOCITY STACK – BLACK (RAW SHOWN INSET)

REVOLUTION® MAX 39

Intakes

F. CHROME EXHAUST SHIELDS

Use these shields to quickly and easily change the exhaust appearance to add some contrast. The perfect complement to a chrome Heavy Breather.

65400681		\$149.95
Fits '22-later RH975 models.		

G. HEAVY BREATHER AIR CLEANER

This forward-facing exposed element Air Cleaner kit is sure to turn heads at the starting line. Featuring a gloss back or chrome elbow and exposed high-flow filter, the performance feel is unmistakable. Exposed high-flow filter for an aggressive, high-performance look. Washable and rechargeable filter element saves time and money over the long run versus buying replacement filters. Lightweight die-cast aluminum intake tube and backing plate for smooth airflow into the engine. Kit includes all necessary mounting hardware

Fits '22-later RH975 models

29400442	Chrome.	\$359.95
29400440	Black.	\$359.95

H. VELOCITY STACK

Add the look of wide-open performance with this hot rod style side-draft intake. 2.5" spun aluminum stack with hidden fasteners and a durable black anodized finish for a clean custom look. Stainless steel mesh screen adds classic detail. Black backing plate lets the raw velocity stack pop with contrast

Fits '22-later RH975 models

29400453	Black.	\$224.95
29400433	Raw w/ Clear.	\$224.95

Notice: The prices appearing in this catalog are the manufacturer's suggested retail prices. Actual retail prices may vary.

Notice: The prices appearing in this catalog are the manufacturer's suggested retail prices. Actual retail prices may vary.

40 REVOLUTION® MAX

Wild One™ Collection

WILD ONE™ COLLECTION

Add daring, raw-and-rugged style with durable billet aluminum Wild One™ Collection accessories. Each is finished in gloss black with bright, machined aluminum highlights, a variety of textures and exposed hardware to communicate power, speed, and performance.

A. WILD ONE™ COLLECTION – HAND GRIPS

Glueless design permits removal for servicing without damage. Rubber provides a positive grip while riding. Sold as a pair.

56100462 **\$138.95**

Fits '21-later Revolution® Max engine-equipped models. Does not fit models with original equipment heated grips.

56100483 Heated. **\$244.95**

Fits '21-later RA1250S, RH1250S and RH975S models.

RH1250S and RH975S models require a Digital Technician™ update by a Harley-Davidson® dealer.



A. WILD ONE COLLECTION – HAND GRIPS

B. WILD ONE COLLECTION – MIRRORS

Includes Left and Right mirror and mounting hardware.

56000241 **\$234.95**

Fits '21-later Revolution Max engine-equipped models.

RH975, RH975S and RH1250S models require separate purchase of Handlebar End Cap P/N 55801095, 55900246, 55900247 or 55900248.



B. WILD ONE COLLECTION – MIRRORS

C. WILD ONE COLLECTION – RIDER FOOTPEGS

Includes Left and Right footpegs.

50502020 Rider. **\$158.95**

Fits rider position on '21-later RH1250S models.

50502026 Passenger. **\$158.95**

Fits passenger position on '21-later RH1250S, '22-later RH975 and '23-later RH975S models. RH1250S models require separate purchase of Passenger Footpeg Mount Kit P/N 50502192A. RH975 models require separate purchase of Passenger Footpeg Mount Kit P/N50502434.



C. WILD ONE COLLECTION – RIDER FOOTPEGS

D. WILD ONE COLLECTION – CAM SPROCKET MEDALLIONS

Sold as a set of two adhesive covers.

14101557 **\$104.95**

Fits '21-later Revolution Max engine-equipped models.

E. WILD ONE COLLECTION – ALTERNATOR PLUG COVER

Includes Left and Right mirror and mounting hardware.

25701181 **\$104.95**

Fits '21-later Revolution Max engine-equipped models.

F. WILD ONE COLLECTION – CLUTCH MEDALLION

HDMC "dog tag" style logo adds subtle authenticity. Includes mounting hardware.

14101402 **\$132.95**

Fits '21-later Revolution Max engine-equipped models.

G. WILD ONE COLLECTION – TIMER MEDALLION

Machined aluminum highlights. Includes mounting hardware.

14101398 **\$63.95**

Fits '21-later Revolution Max engine-equipped models.

For additional Collections that fit Sport models, see the Engine Trim and Controls sections of this catalog.



D. WILD ONE COLLECTION – CAM SPROCKET MEDALLIONS



E. WILD ONE COLLECTION – ALTERNATOR PLUG COVER



F. WILD ONE COLLECTION – CLUTCH MEDALLION



G. WILD ONE COLLECTION – TIMER MEDALLION



H. FRONT AXLE NUT COVERS – GLOSS BLACK



I. REAR AXLE NUT COVERS – GLOSS BLACK



J. SWINGARM PIVOT BOLT COVERS – GLOSS BLACK



K. SECURITY SIREN KIT

REVOLUTION® MAX 41

Chassis Trim

H. FRONT AXLE NUT COVERS – GLOSS BLACK

Cover the front axle in style. These smooth custom die-cast Axle Nut Covers add the finishing detail to complete a custom front end. Easy to install. Includes all necessary mounting hardware. Sold in pairs

43000214 **\$47.95**

Fits '21-later Revolution Max engine-equipped models.

I. REAR AXLE NUT COVERS – GLOSS BLACK

Cover the rear axle in style. These smooth custom die-cast Axle Nut Covers add the finishing detail to complete the custom look. Easy to install. Includes all necessary mounting hardware. Sold in pairs

43000215 **\$45.95**

Fits '21-later RA1250, RA1250S and RH1250S models.

J. SWINGARM PIVOT BOLT COVERS – GLOSS BLACK

Conceal the swingarm pivot bolt for a clean style detail. These easy-to-install covers hide the Original Equipment hardware. Gloss black finish. Kit includes left and right die-cast pivot bolt covers. Easy to install

47500047 **\$42.95**

Fits '21-later RH1250S models. Does not fit with Passenger Footpeg Mount Kit P/N 50502192.

K. SECURITY SIREN KIT

Plug in this very loud siren for additional peace of mind that your motorcycle is protected. The siren sounds an alarm when the Factory Security System is activated. Easy-to-install plug-and-play connection to vehicles equipped with a Harley-Davidson® Factory Security System. Homologated for international use

69000124 **\$83.95**

Fits '21-later RA1250, RA1250S, RH975, RH975S and RH1250S models, '17-later XG, '02-'17 VRSC™, '14-later XL, '04-'17 Dyna®, '03-later Softail® (except FXCW and FXCWC), '02-later Touring and '09-later Trike models equipped with H-D® Smart Security System or H-D® Factory Security System. '21-later RA1250, RA1250S and RH1250S models require separate purchase of Adapter Wire P/N 69202993 and two cable ties P/N 10065. '17-later XG models require separate purchase of mounting bracket P/N 69201473. 2002-2006 VRSCA, VRSCB, VRSCD Models require the purchase of a loop side Velcro strip, P/N 59274-01.

Also available:

SIREN ADAPTER WIRE

Required to install Security Siren P/N 69000124 on '21-later RA1250, RA1250S, RH975S and RH1250S models.

69202993 **\$33.95**



Adversary Collection Hand Grips

468

HARLEY-DAVIDSON® CRUISER - FXBR

BREAKOUT 117

Don't cramp your ride. A Tallboy® Two-Up seat is designed to move the long-inseam rider up and back for custom comfort. LED Bullet Turn Signal Inserts, machine cut Front Axle Nut Covers and billet aluminum Adversary™ Collection Hand Grips and Mirrors add eye-catching style details that will earn this bike second looks.



Front Axle Nut Covers

146



LED Bullet Turn Signal Insert Kit

616



Tallboy Two-Up Seat

116



Tall Handlebar Risers

542

HARLEY-DAVIDSON® CRUISER - FXBBS

STREET BOB 114

The weekend called. Get ready with new leather-and-nylon weather-proof Overwatch Quick-Release Saddlebags and the horizon-hunting comfort of a Badlander® Seat. For West Coast style we've added Tall Handlebar Risers plus Flat-Out Bar tip-over protection. Look good and get lost.



Flat-Out Bar

142



Badlander Seat

118



Overwatch Quick-Release Saddlebags

130



Vivid Black Softail Quarter Fairing

106

HARLEY-DAVIDSON® CRUISER - FXLRS

LOW RIDER S

Dig a West Coast vibe behind a color-matched Vivid Black Softail® Quarter Fairing. The edgy Bevel Solo Seat with aluminum button details, Flat-Out Bar tip-over protection and industrial Endgame Rider Footpegs complete a custom look that's hard and aggressive.



Flat-Out Bar

142



Bevel Solo Seat

113



Endgame Collection Rider Footpegs

478

LOW RIDER S



Light Smoke 10-inch Windshield

110

HARLEY-DAVIDSON® CRUISER - FXLRST

LOW RIDER ST

Built for road trippin'. A two-up Sundowner™ Seat, detachable Holdfast™ Sissy Bar with backrest pad and Passenger Footpeg Support provide passenger comfort. For the rider, heated grips and the wind protection of a Light Smoke 10-inch Windshield. The miles will roll by in a hurry.



HoldFast Sissy Bar Upright - Standard Height

124



Sundowner Seat

118



Passenger Footpeg Support Kit

114



Overwatch Small Handlebar Bag

652

HARLEY-DAVIDSON® CRUISER - FXFBS

FAT BOB 114

We built a street scorcher. A Milwaukee-Eight® Stage III Kit and Screamin' Eagle® High Flow Exhaust System produce potent performance. Mid-Controls, Tall Risers and our Flush Mount Fuel Cap amp up the attitude. Stash essentials in the Overwatch Small Handlebar Bag. Green light means go!



Flush Mount Fuel Cap

149



Mid-Control Kit

136



Screamin' Eagle High-Flow Exhaust System

346

FAT BOB® 114



Tall Handlebar Risers

542

HARLEY-DAVIDSON® CRUISER - FXST

SOFTAIL STANDARD

Power to the pavement. Take it to the limit with the Screamin' Eagle® 131 Crate Engine and High-Flow Exhaust, then take it on the road with the Overwatch Dry Backpack. Tall Handlebar Risers hold Adversary Collection Hand Grips that complement the new Adversary Derby Cover. Aggressive – that's an understatement.



Overwatch Dry Backpack

652



Adversary Collection Derby Cover

425



Adversary Collection Rider Footpegs

469

SOFTAIL® STANDARD



Empire Collection Hand Controls

472

HARLEY-DAVIDSON® CRUISER - FLHCS

HERITAGE CLASSIC

Black is back. Gloss Black Rear Saddlebag Guards and Empire™ Collection Hand Controls and Derby Cover contrast perfectly with this bike's Prospect Gold paint. Add the deep rumble of Screamin' Eagle® Street Cannon Exhaust and make a stirring entrance when bike night rolls around.



Gloss Black Rear Saddlebag Guards

132



Empire Collection Derby Cover

428



Screamin' Eagle Street Cannon Mufflers

347

HERITAGE CLASSIC



HARLEY-DAVIDSON® CRUISER - FLFBS

FAT BOY 114 ANNIVERSARY EDITION

Celebrate the 120th Anniversary together with the HoldFast™ Sissy Bar, providing long-range comfort and support for you and your passenger. Add some extra custom detail by emphasizing the long and lean fuel tank with a Flush-Mount Fuel Cap and the Aluminator Billet Front Axle Nut Covers. Call it icing on the birthday cake.



HoldFast Sissy Bar Upright - Standard Height

124



Flush-Mount Fuel Cap

149



Aluminator Billet Front Axle Nut Covers

146

58 CRUISER

Windshields

A. QUICK-RELEASE SUPER SPORT WINDSHIELD

Reduces the pounding of wind and shower of bugs, but keeps the wind-in-the-hair feeling. Ideal for a cool morning ride, the sleek profile of the Super Sport Windshield hugs the front headlamp for a sporty look. The windshield mounts to the fork tubes with elegant die-cast lever locking clamps, so the windshield does not require any leave-behind docking hardware. You get quick on-and-off convenience and a clean, custom look. No tools are required and the kit includes everything needed to install the windshield.

57838-08 19" Light Smoke. **\$385.95**
Fits '88-'22 XL (except XL1200CX, XL1200T, XL1200X, XL1200XS and '11-'22 XL883L and XL1200C). XL1200NS requires removal of headlight visor. Also fits '91-'05 Dyna® models (except FXDWG and FXDXT). XL Custom models require Front Directional Relocation Kit P/N 68517-94A. Windshield dimensions: Overall height – 25.0"; width – 20.1".

B. QUICK-RELEASE COMPACT WINDSHIELD

Combine the classic Harley-Davidson® windshield shape with a revolutionary new attachment system and you have the best of style and function. The windshield mounts to the fork tubes with elegant die-cast lever-release clamps, so the windshield does not require any leave-behind docking hardware. You get quick on-and-off convenience and a clean, custom look. No tools are required and the kit includes everything needed to install the windshield. The tough, hard-coated polycarbonate windshield is available with traditional polished or gloss black horizontal and vertical braces.

Fits '88-'22 XL (except XL1200CX, XL1200T, XL1200X, XL1200XS and '11-'22 XL883L and XL1200C). XL1200NS requires removal of headlight visor. Also fits '91-'05 Dyna models (except FXDWG and FXDXT).

58063-04 18" Clear – Polished Braces. **\$427.95**
Windshield dimensions: Overall height – 26.8"; width – 19.7".

58706-09 18" Clear – Black Braces. **\$450.95**
Windshield dimensions: Overall height – 26.8"; width – 19.7".

58602-04 14" Light Smoke – Polished Braces. **\$435.95**
Windshield dimensions: Overall height – 22.8"; width – 19.5".

58703-09 14" Light Smoke – Black Braces. **\$456.95**
Windshield dimensions: Overall height – 22.8"; width – 19.5".

Fits '11-'22 XL883L and XL1200C and '14-'20 XL1200T models. Windshield dimensions: Overall height 22.8"; width 19.5".

57801-11 18" Clear – Polished Braces. **\$427.95**
Windshield dimensions: Overall height 26.8"; width 19.7".

57802-11 14" Light Smoke – Polished Braces. **\$435.95**
Windshield dimensions: Overall height 22.8"; width 19.5".

Fits '16-'22 XL1200X and XL1200XS models.

57400318 19" Clear – Black Braces. **\$456.95**

57400319 15" Light Smoke – Black Braces. **\$461.95**



A. QUICK-RELEASE SUPER SPORT WINDSHIELD



B. QUICK-RELEASE COMPACT WINDSHIELD – (GLOSS BLACK BRACES SHOWN)



C. SPORT WINDSHIELD KIT – (58192-87A SHOWN)



C. SPORT WINDSHIELD KIT – (58024-96A SHOWN)



D. QUICK-RELEASE SUPER SPORT WINDSHIELD –XL1200CX



E. H-D DETACHABLES QUARTER FAIRING KIT

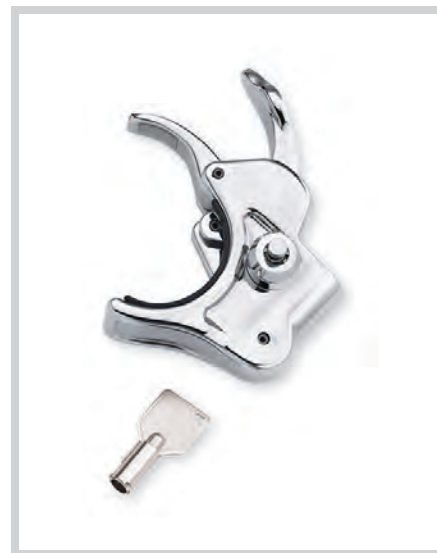

F. LOCKING QUICK-RELEASE WINDSHIELD CLAMP



G. FRONT TURN SIGNAL RELOCATION KIT

CRUISER 59

Windshields

C. SPORT WINDSHIELD KIT

Formed of polycarbonate and hard-coated to resist scratching. Light smoke windshield is contoured to fit the headlamp and incorporates adjustable four-point mounting. Functional styling helps deflect wind to reduce upper body fatigue.

58192-87A 18" Light Smoke. **\$197.95**
Fits '88-'22 XL (except XL883C, XL1200C, XL1200CX, XL1200T, XL1200X, XL1200XS and '11-'22 XL883L). XL1200NS requires removal of headlight visor. Also fits '95-'05 Dyna® models (except FXDWG and FXDXT). Includes black mounting hardware. Windshield dimensions: Overall height – 18.5"; width – 16.3".

58024-96A 17" Light Smoke. **\$213.95**
Fits '96-'10 XL883C and XL1200C, '10 XL1200X, '99-'00 FXR and '87-'94 FXLR models. Windshield dimensions: Overall height-19.1"; width-16.3".

D. QUICK-RELEASE SUPER SPORT WINDSHIELD

Reduces the pounding of wind and shower of bugs but keeps the wind-in-the-hair feeling. The windshield mounts to the fork tubes with elegant die-cast lever locking clamps, so the windshield does not require any "leave-behind" docking hardware. You get quick on-and-off convenience and a clean, custom look. No tools are required and the kit includes everything needed to install the windshield.

57400345 11" Gradient. **\$396.95**
Fits '16-'20 XL1200CX models. Overall height – 13.8"; width – 12.8".

E. H-D® DETACHABLES™ QUARTER FAIRING KIT

Sleek, racy styling and sweeping lines are the make-up of this innovative fairing. Its quarter-sized, detachable design gives your bike a whole new, sporty look that can be changed in an instant. Available in Primed or Vivid Black. Requires the installation of Detachable Docking Hardware Kit P/N 58164-96A.

Fits '88-'12 XL (except XL883C, XL883N, XL1200C, XL1200CX, XL1200T, XL1200V and XL1200X and '11-'22 XL883L), FXR and '95-'05 Dyna models (except FXDWG, FXDXT and FXLR).

57070-97DH Vivid Black. **\$477.95**

F. LOCKING QUICK-RELEASE WINDSHIELD CLAMP

Kit includes one locking clamp and two matching keys.

57400536 39mm. **\$82.95**

Fits '88-'22 XL (except '16-'22 XL1200CX, XL1200X and XL1200XS) and '91-'05 Dyna models (except FXDWG) equipped with Quick-Release Style windshields.

G. FRONT TURN SIGNAL RELOCATION KIT

Fits '88-'22 XL (except XL1200CX, XL1200T, XL1200X, XL1200XS and '11-'22 XL883L and XL1200C) and '91-'05 Dyna models (except FXDWG and FXDXT).

68517-94A Chrome. **\$43.95**

68643-09 Gloss Black. **\$38.95**

60 CRUISER

Seating – Reach® & Tallboy®

A. SUPER REACH® SOLO SEAT

Get a little bit closer. Super Reach® forward position seats are designed to move riders with a shorter inseam even closer to the controls and to bring the legs closer together so that your feet rest firmly on the pavement. After hundreds of hours of on-road and ergonomic testing, the seat shape and foam density were selected as the ideal position for riders 5'-0" to 5'-4" tall. The Super Reach Seat moves the rider 1.5" closer to the controls compared to stock seat on XL883L model, and 2" closer and .5" lower compared to stock seat on XL1200C model. The nose is 1.0" narrower than the stock seat, and it is tastefully sculpted to look great with any size Sportster® fuel tank. The combination of premium textured and smooth vinyl surfaces and charcoal gray stitching and embroidered Bar & Shield logo really set the seat apart. For the ultimate solo touring setup, add the Quick Release Rider Backrest P/N 52300245.

52000207 **\$276.95**
Fits '10-'22 XL models. Seat width 9.5".

B. REACH SEAT

Designed specifically for riders requiring a close to the bar riding position, without compromising comfort. This seat positions the rider approximately .5" forward, closer to the hand and foot controls. The narrow front profile brings your legs closer together to help you plant your feet firmly on the ground. The slightly bucketed rider seat offers lower back support and features a textured insert to prevent you from sliding around while riding.

51737-07 **\$336.95**
Fits '07-'22 XL models equipped with 2.2 or 3.3 gallon fuel tanks. Models not equipped with passenger pegs require separate purchase of Passenger Footpeg Kit P/N 50203-04 ('04-'13 models) or P/N 50500270 ('14-'22 models). XL883N, XL1200N and XL1200X models also require separate purchase of Retention Washer P/N 7487. Seat width 14.0"; passenger pillion width 10.0".

C. SIGNATURE SERIES® SOLO SEAT WITH RIDER BACKREST

A perfect combination of foam density and shape has created our most comfortable seat for long-haul touring. The wide seating area will keep the rider extra comfy on a long trip and when you reach your destination, city driving will be easier with the narrow nose that helps keep your legs closer together. Seat features an easily removable adjustable rider backrest that folds down for easier passenger mounting. Rider backrest has a 5-position height adjustment with 1.5" range and a wide range of forward/back angle adjustment with a quick twist of the control knob. Matching Passenger Pillion P/N 52400053 is available for added versatility.

52000062 **\$532.95**
Fits '07-'22 XL models with 2.2 or 3.3 gallon fuel tank. Seat width 15.0".



A. SUPER REACH SOLO SEAT



B. REACH SEAT



C. SIGNATURE SERIES SOLO SEAT WITH RIDER BACKREST



Reach Seats



Tallboy Seats

Notice: The prices appearing in this catalog are the manufacturer's suggested retail prices. Actual retail prices may vary.

CRUISER 61

Seating — Comfort & Touring

D. SUNDOWNER™ SOLO SEAT

Ride sun-up to sun-down in comfort and style. The Sundowner™ Solo Seat's shape and foam density were developed and refined during hundreds of hours of test rides and ergonomic evaluations. The unique seat features a deep bucket design that cradles the tailbone and provides back support for the rider. The narrow nose of the seat was sculpted to bring the legs closer together, and to look great with any size Sportster® fuel tank. The seat is constructed with premium textured vinyl surfaces for comfort and durability, and features embroidered Bar & Shield logos for style. For two-up riding, simply add the comfortable Sundowner Passenger Pillion P/N 52400121.

52000203 **\$276.95**
Fits '10-'22 XL models. Not compatible with Rider Backrest P/N 52300245. Seat width 15.0".

E. SIGNATURE SERIES® PASSENGER PILLION

This carefully styled pillion matches the Sportster Signature Series® Solo Seat and provides your passenger with a wide seating surface for hours of comfort.

52400053 **\$170.95**
Fits '07-'22 XL models equipped with Signature Series Solo Seat P/N 52000034 or 52000062. Pillion width 10.0".

F. SUNDOWNER PASSENGER PILLION

Bring someone along for the ride without giving up your solo status. This carefully styled pillion matches the Sportster Sundowner Solo Seat and provides the passenger with great Sundowner comfort. The pillion is shaped to maximize support on a long ride, and is constructed with premium foam and textured vinyl for years on the road.

52400121 **\$170.95**
Fits '10-'22 XL models (except XL1200CX) equipped with Sundowner Solo Seat P/N 52000203. Models not equipped with passenger pegs require separate purchase of Passenger Footpeg Kit P/N 50500270 ('14-later models) or 50203-04 ('10-'13 models). Pillion width 11.0".

G. SUNDOWNER™ SEAT

The Sundowner™ Seat provides the maximum in long-riding comfort. The deep-bucket design puts your body in the proper touring position and the generous padding makes it comfortable for both the rider and passenger as the miles are adding up. The dish shape provides added rider back support and the wide passenger pillion is shaped to minimize pressure points.

51736-07 **\$351.95**
Fits '07-'09 XL models equipped with 2.2 or 3.3 gallon fuel tanks. Models not equipped with passenger pegs require separate purchase of Passenger Footpeg Kit P/N 50203-04. XL883N, XL1200N and XL1200X models also require separate purchase of Retention Washer P/N 7487. Seat width 14.5"; passenger pillion width 12.0".



D. SUNDOWNER SOLO SEAT



E. SIGNATURE SERIES PASSENGER PILLION



F. SUNDOWNER PASSENGER PILLION



G. SUNDOWNER SEAT (SHOWN WITH SMOOTH BUCKET LOW BACKREST PAD)

Notice: The prices appearing in this catalog are the manufacturer's suggested retail prices. Actual retail prices may vary.

62 CRUISER

Seating — Comfort & Low Profile

A. BRAWLER® SOLO SEAT

When it's time to go it alone, go in style. These premium quality cowhide leather solo saddles feature a smooth, sleek design that hugs the frame rails for a true custom look. The Brawler® seat's design places the rider "in" the bike for a low-slung riding position, and features a kick-up in the rear to hold the rider in place. The seating position is generally lower than stock, but not as far back as Badlander® or other low-profile seats. The top-grain leather seating surface and contoured foam padding provide a firm but luxurious feel. Seat does not fit with passenger pillions.

52000269 **\$319.95**
Fits '10-'22 XL models. Does not fit with Rider Backrest P/N 52300245. Seat width 12.5".



A. BRAWLER SOLO SEAT

B. LEATHER BADLANDER® SEAT

The traditional Badlander® seat's low and lean style sets the stage for your minimalist custom ride. The frame-hugging rider seat and the slim tapered passenger pillion visually stretch the bike and enhance the slammed look. The seat shape stays low along its entire length and follows the lines of the bike with minimal disruption, and delivers a riding position that is lower and generally farther back than the stock seat. Ideal for both short riders needing to be closer to the ground, or for tall riders who want to move back in the bike without sitting higher. This seat is wrapped in supple top-grain leather and finished with an embroidered Harley-Davidson script. Kit includes leather grab strap and mounting hardware.

52000259 **\$362.95**
Fits '10-'22 XL models. XL1200CX requires separate purchase of Low-Profile Sissy Bar Upright P/N 52300403. Models not equipped with passenger pegs require separate purchase of Passenger Footpeg Kit P/N 50203-04 ('10-'13 models) or P/N 50500270 ('14-'22 models). Seat width 11.5"; passenger pillion width 5.5".



B. LEATHER BADLANDER SEAT

C. BADLANDER CUSTOM SEAT

It's good to be bad. The low and lean Badlander Custom Seat is designed to fit your bike like a glove. The Badlander Seat delivers low-slung cruiser style from the fuel tank to the rear fender, and gives you the feeling of sitting "in" the bike and not on top of it. Ideal for both short riders needing to be closer to the ground, or for tall riders who want to move back in the bike without sitting higher, the seat delivers a riding position that is lower and generally farther back than the stock seat. This Badlander Seat features rich textured vinyl seating surfaces for durability, and charcoal black leather side panels and dark gray stitching and Harley-Davidson embroidered script for style. The narrow nose of the seat is sculpted to complement any size Sportster® fuel tank.

52000211A **\$266.95**
Fits '10-'22 XL models. Models not equipped with passenger pegs require separate purchase of Passenger Footpeg Kit P/N 50203-04 ('10-'13 models) or P/N 50500270 ('14-'22 models). XL1200CX requires separate purchase of Low Profile Sissybar Upright P/N 52300403. Seat width 11.5"; passenger pillion width 5.5".



C. BADLANDER CUSTOM SEAT

D. BOBBER SOLO SADDLE

How low can you go? This minimalist solo seat takes the stripped-down garage-built look about as far as you can go. The thick distressed black leather cover is bonded directly to the formed metal seat pan and minimizes the foam filler and the extra height it brings. The raw-edge leather pad is joined to the pan with brass rivets, and features matching brass "Milwaukee Since 1903" trim that will develop a rich patina with use. The Bar & Shield logo is embossed into the leather surface as a finishing touch. Easy to install, the bolt-on seat and a model-specific installation kit includes everything you need to get the bobber look. No cutting, welding or fabrication is necessary.

52000277 **\$319.95**
Distressed Black Leather.
Fits '04-'06 and '10-'22 XL, '06-'17 Dyna® and '08-'17 FLS, FLSS, FLSTC, FLSTN and FXS models. Installation requires separate purchase of model-specific Rigid or Spring Seat Mounting Hardware Kit. Seat width 10.5".

Also available:

RIGID MOUNT SADDLE INSTALLATION KIT

Get the low, lean, minimalistic, garage-built look. Required for installation of Solo Saddle Kits P/N 52000277, 52000279, 52000278, 52000275, 52000276, 52000180, 54072-10, 54373-10, 52000114 and 52000113. Kit includes mounting brackets and hardware.

52100016 **\$245.95**
Fits '10-'22 XL models.



D. BOBBER SOLO SADDLE (SHOWN WITH RIGID MOUNT SADDLE INSTALLATION KIT)



E. SOLO SADDLE - BLACK DIAMOND



F. PASSENGER PILLION — (52400125 SHOWN)



F. PASSENGER PILLION — (52400127 SHOWN)



G. QUICK-RELEASE RIDER BACKREST



H. QUICK-RELEASE SEAT HARDWARE KIT - CHROME



H. QUICK RELEASE SEAT HARDWARE KIT - GLOSS BLACK

CRUISER 63

Seating — Low Profile

E. SOLO SADDLE

Add nostalgic bobber looks to your modern Harley-Davidson® motorcycle. Available in elegant leather, this solo seat features a low-profile design that provides the minimalistic "just enough to ride" look. The smooth metal seat pan and the simple frame cover leave a clean, finished appearance. Easy to install, the bolt-on seat and model-specific Spring Seat Installation Kit include everything you need to get the bobber look. No cutting, welding or fabrication is necessary and the seat can be removed and replaced with a touring seat for a two-up night on the town.

Fits '04-'06 and '10-'22 XL, '06-'17 Dyna® and '08-'17 FLS, FLSS, FLSTC, FLSTN and FXS models. Installation requires separate purchase of model-specific Rigid or Spring Seat Mounting Hardware Kit. Seat width 10.5".

52000276 Black Diamond. **\$319.95**

F. PASSENGER PILLION

Bring a guest along on your solo seat-equipped Sportster® model. The cover and stitching of this Passenger Pillion complements the solo seat. Kit includes grab strap and mounting hardware.

52400125 '16 XL1200X Style. **\$149.95**
Fits '16-'22 XL1200X and XL1200XS models with Original Equipment solo seat. Models not equipped with passenger pegs require separate purchase of Passenger Footpeg Kit P/N 50500270. Seat width 7.5".

52400127 '16 XL883N Style. **\$139.95**
Fits '16-'22 XL883N models with Original Equipment solo seat. Models not equipped with passenger pegs require separate purchase of Passenger Footpeg Kit P/N 50500270. Seat width 7.5".

G. QUICK-RELEASE RIDER BACKREST

Add exceptional comfort for open road and around town riding. This detachable rider backrest is shaped for maximum lower back support and keeps you in place without shifting you forward in the saddle. Designed to complement Original Equipment and accessory solo seats, the backrest's forward/back position can be adjusted up to 4.5" with a simple fingertip adjustment. The fold-down pad clears the way when throwing your leg over the bike and the backrest can be removed from the bike with the push of a button—leaving behind just two elegant docking points. Complete kit includes upright, pad, fender strut brackets and all required hardware.

52300245 **\$266.95**
Fits '04-'22 XL models equipped with a solo seat. Not compatible with Brawler® Solo Seat P/N 52000269, 52941-04B, 52000118, 52000119, Cafe Solo Seat P/N 52000260, Sundowner™ Solo Seat P/N 52000203, Tallboy® Solo Seat P/N 52000209, Solo Rigid or Spring Seat Mounting Kits, '16-'22 Original Equipment XL883N Solo Seat, or Side-Mount License Plate Kits P/N 60947-10 or 60972-10. Installation of H-D® Detachables™ Solo Luggage Rack requires additional purchase of Bolt P/N 3584 (Qty. 4).

H. QUICK-RELEASE SEAT HARDWARE KIT

This Quick-Release Hardware Kit allows the rider to remove one-piece Harley-Davidson® seats quickly and easily. A raised-logo Harley-Davidson emblem finishes the look. SAE 1/4"-20 thread.

Fits '97-'22 XG, XL, Dyna, Softail® (except '12-'17 FLS models equipped with Original Equipment seat), Touring and Trike models equipped with SAE 1/4"-20 seat mount hardware. Does not fit seats equipped with spring-loaded rear seat bracket.

51676-97A Chrome. **\$23.95**
10500093 Gloss Black. **\$23.95**

NOTE: Some Harley-Davidson® seats are made of leather. Fine leathers or other natural materials WILL gain "character," such as wrinkles or wear, with age. This is normal. A fine, aged patina and character wrinkles are a sign of the extremely high-quality materials used to construct your seat or backrest. The appearance of scars or marks on the leather are a result of using natural leather panels and should not be thought of as an imperfection. Please use Harley-Davidson Leather Protectant P/N 93600034 to protect your investment.

Notice: The prices appearing in this catalog are the manufacturer's suggested retail prices. Actual retail prices may vary.

Notice: The prices appearing in this catalog are the manufacturer's suggested retail prices. Actual retail prices may vary.

64 CRUISER

Backrests & Racks

A. H-D® DETACHABLES™ SIDEPLATES

In the time it takes for a traffic light to change, you can transform your motorcycle from a city cruiser to a cross-country hauler. Start with Harley-Davidson® Detachables™ Sideplates, and add your choice of sissy bar upright and pad to make removing the passenger backrest a simple slide and click operation. Manufactured and tested to rigorous Harley-Davidson standards; installation requires separate purchase of model-specific Docking Hardware Kit.

Fits '04-'22 XL models (except '16-'22 XL1200CX). All models require separate purchase of Docking Hardware Kit (see docking hardware matrix). Docking hardware is Original Equipment on XL1200T models.

1. 53913-04	Chrome.	\$160.95
2. 52710-07	Gloss Black.	\$160.95

B. LOW SISSY BAR UPRIGHT

Shaped to complement a thicker passenger pillion, this Low Sissy Bar Upright stands between the Standard and Short Sissy Bar Upright. The ideal match for touring style seats, this upright also offers an additional height option to riders with custom-style seats.

Fits '04-'22 XL models with H-D® Detachables™ sideplates, '06-'17 Dyna® (except FXDF, FXDFSE and '10-'17 FXDWG), '84-'05 Softail® (except FXSTD) and '06-later FL Softail models (except '07-'17 FLS, FLSS, FLSTF, FLSTFB, FLSTFBS, FLSTSE and FLSTSB and '06 FLSTFSE) with appropriate sideplates.

52300022	Chrome.	\$119.95
-----------------	---------	-----------------

C. STANDARD SISSY BAR UPRIGHT

Give your passenger additional back support with a Standard Sissy Bar Upright, designed to accept a wide variety of Backrest Pads.

Fits '04-'22 XL models with H-D Detachables sideplates, '06-'17 Dyna (except FXDF, FXDFSE and '10-'17 FXDWG), '84-'05 Softail (except FXSTD) and '06-later FL Softail models (except '07-'17 FLS, FLSS, FLSTF, FLSTFB, FLSTFBS, FLSTSE and FLSTSB and '06 FLSTFSE) with appropriate sideplates.

52300018	Chrome.	\$116.95
52300020	Gloss Black.	\$116.95



A. H-D DETACHABLES SIDEPLATES

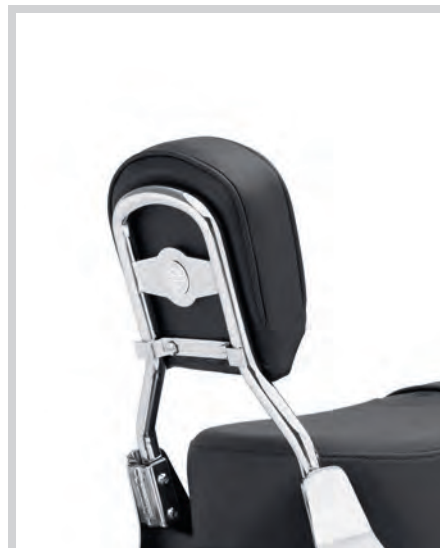

B. LOW SISSY BAR UPRIGHT – CHROME



C. STANDARD SISSY BAR UPRIGHT – CHROME



D. ONE-PIECE H-D DETACHABLES SISSY BAR UPRIGHT – GLOSS BLACK (SHOWN WITH SMOOTH BACKREST PAD)



D. ONE-PIECE H-D DETACHABLES SISSY BAR UPRIGHT – CHROME (SHOWN WITH SMOOTH BACKREST PAD)

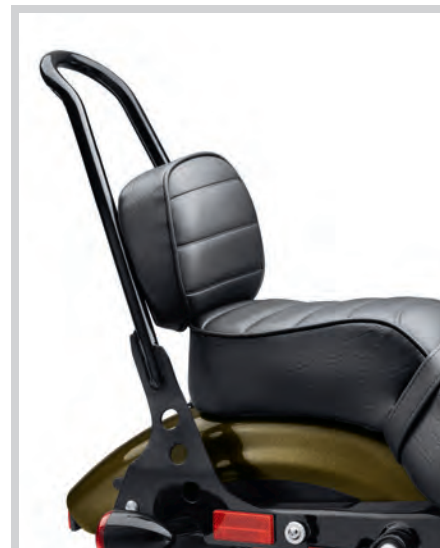

E. PASSENGER BACKREST PAD – XL883N STYLE



E. PASSENGER BACKREST PAD – XL1200X STYLE



F. LOW-PROFILE SISSY BAR UPRIGHT



G. SLIP-OVER PASSENGER BACKREST PAD

65 CRUISER

Backrests & Racks

D. ONE-PIECE H-D® DETACHABLES™ SISSY BAR UPRIGHT

The sweeping shape of this slim, round bar Sissy Bar Upright completes the classic bobber look. The one-piece design eliminates separate sideplates for a clean appearance and the stylized upper kick angle mimics the old-school sissy bars of the '50s and '60s. Available in your choice of chrome or gloss black finish, these bars can be equipped with Passenger Backrest Pad P/N 52631-07.

Fits '04-'22 XL models (except '16-'20 XL1200CX). All models require separate purchase of Docking Hardware Kit (see docking hardware matrix). Docking hardware is Original Equipment on XL1200T models.

51146-10A	Gloss Black.	\$225.95
52300040A	Chrome.	\$225.95

E. PASSENGER BACKREST PADS

Styled to complement available touring and custom seats.

Fits models equipped with One Piece H-D® Detachables™ Sissy Bar Upright P/N 52729-08, 51853-07, 51849-07, 51146-10A, 51161-10A, 52300040A, 52300042A, 52300044A or 52300046A.

52631-07	Smooth Black.	\$79.95
52300366	XL883N Style.	\$84.95
52300364	XL1200X Style.	\$84.95

F. LOW-PROFILE SISSY BAR UPRIGHT

This low and lean one-piece bar mounts between the fender and fender struts for a clean, close-to-the-bike profile. The gloss black round bar upright delivers a simple bobber look on a solo seat-equipped bike, and provides the perfect passenger "butt-stop" for a Sportster® model equipped with a low-profile two-up seat. The bar also accepts Slip-Over Pad P/N 51732-10 for added passenger comfort.

52300403 \$160.95
Fits 16-'20 XL1200CX models with Original Equipment two-up seat and '07-'22 XL models equipped with solo or Badlander® two-up seats.

G. SLIP-OVER PASSENGER BACKREST PAD

This Slip-Over Backrest Pad provides a touch of passenger comfort, while maintaining the long, lean style of the Dyna® Wide Glide® model. Held in place with hook-and-loop tabs, this rich black pad features grey stitching that complements the Original Equipment seat and pillion.

51732-10 \$74.95
Fits '07-'22 XL models with Low-Profile Sissy Bar Upright P/N 52300403 and '10-'17 FXDWG models with Original Equipment sissy bar upright.

SELECT THE DOCKING HARDWARE

Sportster® Docking Hardware for H-D® Detachables™ Racks and Sideplates

Docking hardware fitment is dependent on vehicle model and saddlebag configuration.

H-D Detachables Accessory

	Available to fit:	Required Docking Hardware	
Detachable Sideplates, Detachable Solo Rack 53494-04A, 53512-07A One-Piece Detach Sissy Bar Upright 51146-10A, 52300040A or Detachable Solo Tour-Pak® Rack 53655-04A with Leather Saddlebags 90330-08.	2004-'22 XL models (except XL1200CX)	53544-04	\$54.95
Detachable Sideplates, Detachable Solo Rack 53494-04A, 53512-07A One-Piece Detach Sissy Bar Upright 51146-10A, 52300040A or Detachable Solo Tour-Pak® Rack 53655-04A with Leather Saddlebags 90201321, 90201325 and 88312-07A.	2004-'22 XL models (except XL1200CX)	53544-04	\$54.95
Detachable Sideplates, Detachable Solo Rack 53494-04A, 53512-07A One-Piece Detach Sissy Bar Upright 51146-10A without Leather Saddlebags.	2004-'22 XL models (except XL1200CX)	53529-04	\$54.95
Detachable Sideplates or Detachable Solo Rack 53494-04A, 53512-07A One-Piece Detach Sissy Bar Upright 51146-10A or Solo Tour-Pak Mounting Rack 53655-04A with Hard Saddlebags 91412-0XXX. Hard Saddlebags also require purchase of Hardware Kit 91405-04.	2004-'22 XL models (except XL1200CX)	53529-04	\$54.95
Detachable Sideplates 53545-95A, 53609-01 or Detachable Solo Rack 53495-95 with Leather Saddlebags 90598-04, 90342-04A, 90201329 or 90330-08.	1994-2001 XL models	90465-98A	\$69.95
	2002-2003 XL (except XL883R and XL1200S)	53532-02	\$69.95
Detachable Sideplates 53545-95A, 53609-01 or Detachable Solo Rack 53495-95 without Leather Saddlebags.	1994-2003 XL models (except XL883R and XL1200S)	53528-95B	\$54.95

Notice: The prices appearing in this catalog are the manufacturer's suggested retail prices. Actual pricing may vary.

Notice: The prices appearing in this catalog are the manufacturer's suggested retail prices. Actual retail prices may vary.

SPORTSTER

66 CRUISER

Backrests & Racks

PASSENGER BACKREST PADS

Choose from a wide variety of backrest pad sizes and shapes to match your comfort and style demands. Designed to complement Original Equipment and accessory seats, these pads are engineered to fit specific sissy bar upright types.

A. BACKREST PADS

Sized to fit medallion and mini medallion-style sissy bar uprights. Pad mounts with single center screw and bolt-on mounting strap. Includes chrome-plated mounting hardware.

Fits Low Medallion Style Sissy Bar Upright P/N 52754-04 or 51851-09, Low Square Bar Mini-Medallion Style Sissy Bar Upright P/N 53282-06, Standard Square Bar Mini Medallion Style Sissy Bar Upright P/N 53281-06 or 53407-06, Standard Medallion Style Sissy Bar Upright P/N 52735-85, 53007-98, 52655-84, 52909-02 or 51517-02, Standard Bar & Shield Style Sissy Bar Upright 52739-83 or 51514-02, Standard Heritage Style Sissy Bar Upright P/N 52731-00 and Low Round Bar Sissy Bar Upright P/N 52300022 or 52300024.

- | | | |
|-------------|----------------------|---------|
| 1. 52652-04 | Smooth. | \$79.95 |
| 2. 52626-04 | Smooth Top-Stitched. | \$79.95 |



A. BACKREST PADS

B. BACKREST PADS

Sized to fit medallion and mini medallion-style sissy bar uprights. Pad mounts with single center screw and bolt-on mounting strap. Kit includes chrome-plated mounting hardware.

Fits Low Medallion Style Sissy Bar Upright P/N 52655-84, 52909-02, 52754-04, 51851-09, Standard Medallion Style Sissy Bar Upright P/N 52735-85 or 52877-08, Standard Square Bar Mini Medallion Style Sissy Bar Upright P/N 53281-06 or 53407-06, Standard Heritage Style Sissy Bar Upright P/N 52731-00 and Standard Round Bar Sissy Bar Upright P/N 52300018 or 52300020.

- | | | |
|--------------|-----------------------------|----------|
| 1. 52612-95 | Smooth Top-Stitched. | \$79.95 |
| 2. 52412-79A | Embossed Bar & Shield Logo. | \$84.95 |
| 3. 52348-97 | Heritage Classic Bucket. | \$118.95 |
| 4. 52347-97 | Fat Boy® Bucket. | \$118.95 |
| 5. 51132-98 | Smooth Bucket. | \$107.95 |



B. BACKREST PADS

Notice: The prices appearing in this catalog are the manufacturer's suggested retail prices. Actual retail prices may vary.

CRUISER 67

ENJOY THE RIDE

The relationship between the seat, the handlebar and the foot controls has an enormous impact on the comfort, control and confidence you feel when riding your motorcycle. Once you've picked the bike, it's time to choose the options that match your ride to your personal dimensions.



For shorter riders, consider tailoring your fit by changing to a Reach® Seat, Mid Foot Controls and lowered suspension height.



For taller riders, consider altering your ride by changing to a Tallboy® Seat and Tallboy™ Handlebars.

ESTABLISH YOUR POSITION AND FEEL

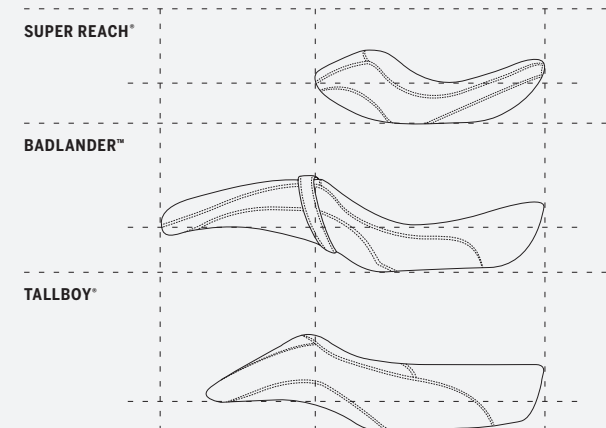

SEATS

Seat height and shape impact rider comfort, fit and confidence. Where the seat positions you relative to the foot controls, hand controls and the ground plays a major role in the quality of your ride.

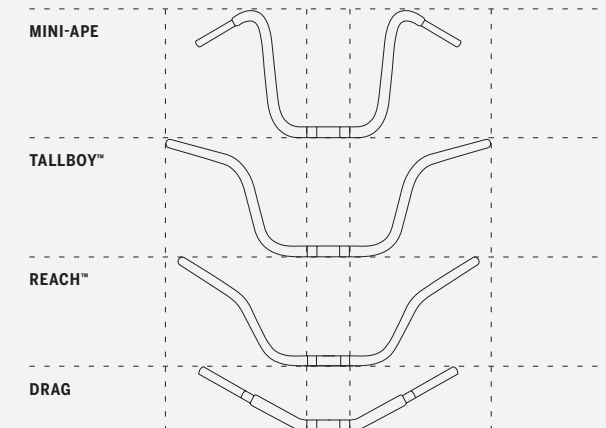

HANDLEBARS

Where the bar positions your arms, hands and wrists directly impacts how you feel on the motorcycle. Choose a bar that falls easily to hand, and does not pull you out of the seat when maneuvering.

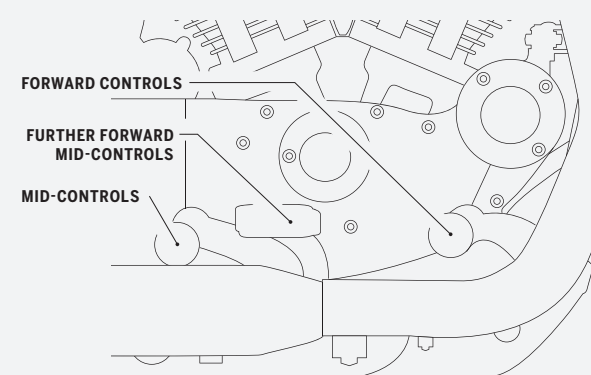

FOOT CONTROLS

Repositioning your feet can relieve muscle tension, take pressure off the tailbone and reduce fatigue. The correct riding position can add hours of comfort and hundreds of miles to your daily saddle time.

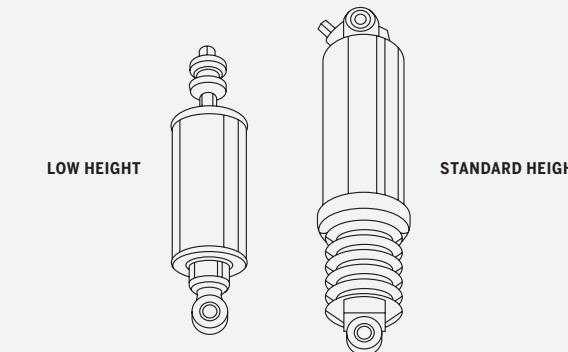

SUSPENSION

Adjusting your motorcycle's ride height by raising or lowering the suspension is often the first step in fitting the bike to your stature. Being sure-footed at a stop can really increase your sense of confidence.

SPORTSTER

68 CRUISER

Backrests & Racks

A. AIR FOIL PREMIUM LUGGAGE RACK*

The low-profile aerodynamic styling defines the look of this Luggage Rack. Available in mirror chrome or rich gloss black finish, the die-cast rear "Air Foil" grabs your attention and the Bar & Shield insert adds a signature touch. The elegant round tube rack features inlaid rubber runners for added grip and dedicated bungee mounting points to simplify luggage tie-down. Kit includes all necessary mounting hardware. For added visibility, the rack is designed to incorporate the internal wiring of the Air Foil Rack LED Light Kit P/N 68000076 for a clean look.

Fits '04-'22 XL models (except XL1200CX) equipped with H-D® Detachables™ Sideplates, '06-'17 Dyna® models (except FXDF, FXDFSE and '10-'17 FXDWG) equipped with Detachable Sideplates, '84-'05 Softail® models (except FLSTN and FXSTD) and '06-'17 FLST, FLSTC, FLSTNSE and FLSTSC models and '06 FLSTF models equipped with Detachable Sideplates.

54290-11	Chrome.	\$230.95
54291-11	Gloss Black.	\$230.95



A. AIR FOIL PREMIUM LUGGAGE RACK – CHROME



A. AIR FOIL PREMIUM LUGGAGE RACK – GLOSS BLACK

B. LED LIGHT KIT**

This fast-acting LED Light Kit operates as a supplemental rear running light and brake light. The high, center-mount position places the light in the line of sight of following vehicles and the bright, fast-acting LED lamps get you noticed. Wiring is concealed inside the rack tubes for a clean, custom installation.

68000076 Red Lens. **\$54.95**
Fits Air Foil Luggage Rack P/N 54290-11, 54291-11 and Air Wing Sissy Bar Upright P/N 52300146 and 52300147. Installation requires separate purchase of model-specific Wiring Harness Kit.

Also available:

LED LIGHT KIT WIRING HARNESS

Required for installation of LED Light Kit on Air Foil Luggage Rack P/N 54290-11 or 54291-11.

70683-08 **\$11.95**
Fits '14-'22 XL models with Air Foil Luggage LED Light Kit P/N 68000076 or 68000077.



B. LED LIGHT KIT

C. FIVE BAR SPORT LUGGAGE RACK – CHROME*

This rack brings touring flexibility to your motorcycle. Can be used with H-D® Detachables™ or Rigid Mount Sissy Bar Sideplates.

53862-00 **\$168.95**
Fits '04-'22 XL models (except XL1200CX) equipped with Detachable Sideplates, '06-'17 Dyna models (except FXDF, FXDFSE and '10-'17 FXDWG) equipped with Detachable Sideplates, '84-'05 Softail models (except FLSTN and FXSTD), '06-'17 FLST, FLSTC and FLSTSC models and '06 FLSTF models equipped with Detachable Sideplates. Does not fit with Round Bar Uprights P/N 52300018, 52300020, 52300022 and 52300024.



C. FIVE BAR SPORT LUGGAGE RACK – CHROME

D. CUSTOM TAPERED SPORT LUGGAGE RACK*

Smooth sweeping curves and the brilliant chrome or gloss black finish define the look of this Sport Luggage Rack. Designed to complement both round and square bar Sissy Bar Uprights, this sleek rack adds a practical and stylish touch to the motorcycle.

Fits '04-'22 XL models (except XL1200CX) equipped with H-D® Detachables™ Sideplates, '06-'17 Dyna models (except FXDF, FXDFSE and '10-'17 FXDWG) equipped with Detachable Sideplates, '84-'05 Softail® models (except FLSTN and FXSTD) and '06-'17 FLST, FLSTC, FLSTNSE and FLSTSC models and '06 FLSTF models equipped with Detachable Sideplates.

50300030	Chrome.	\$168.95
50300031	Gloss Black.	\$168.95



D. CUSTOM TAPERED SPORT LUGGAGE RACK – CHROME



D. CUSTOM TAPERED SPORT LUGGAGE RACK – GLOSS BLACK



E. H-D DETACHABLES SOLO RACK – GLOSS BLACK



F. REAR DOCKING HARDWARE COVER KIT – BLACK



F. REAR DOCKING HARDWARE COVER KIT – CHROME



G. LOCKING H-D DETACHABLES LATCH KIT – BLACK



H. H-D DETACHABLES LATCH KIT – CHROME



H. H-D DETACHABLES LATCH KIT – CHROME

CRUISER 69

Backrests & Racks

E. H-D® DETACHABLES™ SOLO RACK*

Add touring capabilities to your solo seat Sportster® model in less than 60 seconds. This detachable Solo Rack fits over the fender when the passenger pillion is removed. The rack features brazed hand-polished tubing and the chrome-plated or gloss black finish adds a stylish flair. Requires Docking Hardware.

Fits '04-'22 XL models (except XL1200CX) equipped with solo seat. All models require separate purchase of appropriate Docking Hardware. Docking Hardware is Original Equipment on XL1200T models.

53512-07A Gloss Black. **\$221.95**

F. REAR DOCKING HARDWARE COVER KIT

Disguise the rear docking hardware with these easy-to-install covers. The caps slide over the exposed docking points and are held in place by a strong magnetic pull. The caps are easy to remove when you wish to reinstall detachable accessories. Covers are available with brilliant chrome or durable gloss black finish to match your bike's attitude. Sold in pairs.

Fits many accessory docking hardware kits. Refer to the fitment matrix in this P&A Catalog or the Parts & Accessories section of www.harley-davidson.com for details.

48218-10	Short Chrome (pair).	\$38.95
48220-10	Large Chrome (pair).	\$38.95
48035-09	Small Chrome (pair).	\$38.95
48221-10	Short Black (pair).	\$38.95
48223-10	Large Black (pair).	\$38.95
48225-10	Small Black (pair).	\$38.95

G. LOCKING H-D® DETACHABLES™ LATCH KIT

This unique lock replaces the camlock on your Harley-Davidson® Detachables™ accessories, providing additional security and peace of mind when parking your vehicle. The kit includes two extended-reach barrel-style keys for easy access to the lock. Key registration and replacement service is available. Sold in pairs.

Fits all models equipped with detachable Sideplates, Racks and Tour-Pak® Luggage Carriers (except '18-later Softail® models with HoldFast™ racks and uprights or '09-later Touring models equipped with detachable Solo Tour-Pak Rack).

92800008 Black. **\$78.95**

H. H-D DETACHABLES LATCH KIT – CHROME

Decorative chrome latches are the perfect way to enhance the appearance of your detachable accessories. Meticulously polished and chrome-plated, these easy-to-install Rotary Latches are a direct replacement for the Original Equipment satin black parts and are a simple way to add a finishing touch to your ride. Latches feature an easy-to-pull finger release to simplify access in hard-to-reach areas.

12600036 **\$54.95**
Fits all models equipped with detachable Sideplates, One-Piece Sissy Bar Uprights, Racks, and Tour-Pak Luggage Mounting Racks (except '18-later Softail models with HoldFast racks and uprights).



***WARNING:** Do not use this rack as a seat. Do not exceed the fender rack weight capacity. Using as seat or exceeding this capacity could cause handling problems, which could result in loss of control and death or serious injury.



****WARNING:** Disconnecting your DOT-required tail, brake and turn signal lighting could reduce your visibility to others and result in death or serious injury.



***WARNING:** Do not use this rack as a seat. Do not exceed the fender rack weight capacity. Using as seat or exceeding this capacity could cause handling problems, which could result in loss of control and death or serious injury.

Notice: The prices appearing in this catalog are the manufacturer's suggested retail prices. Actual retail prices may vary.

Notice: The prices appearing in this catalog are the manufacturer's suggested retail prices. Actual retail prices may vary.

70 CRUISER

Saddlebags & Luggage

A. RIGID LEATHER LOCKING SADDLEBAGS

The push-button latching swing-out lid is easy to operate with one hand and the fine leather surface and brushed chrome medallion add an elegant touch. The hard-shell design retains its shape in all kinds of weather and is covered in leather for a traditional look. Locking hinged lids offer modern convenience and security. Kit includes reflectors. Luggage Capacity: 2400 cubic inches total.

90201321 **\$809.95**

Fits '04-'22 XL models (except XL1200CX, XL1200T, XL1200V and International (non-Canadian) XL883N, XL1200N or XL1200X models and models with Rear Axle Covers). Models with side-mount license plates require License Plate/Turn Signal Relocation Kit P/N 73279-10. '11-'20 XL1200C models require Turn Signal Relocation Kit P/N 67800071 (Domestic) or 67800077 (International). All other models require separate purchase of Turn Signal Relocation Kit P/N 68732-02A (Domestic), 68733-02A (International) or Layback License Plate Kit P/N 60215-06. Models equipped with H-D® Detachables™ accessories require separate purchase of Docking Hardware Kit P/N 53544-04 (if not already equipped).

B. BLACK STANDARD LINE THROW-OVER SADDLEBAGS

Made of ultra-durable leather-like synthetic featuring a debossed H-D #1 logo, the Black Standard Bags have a simple, black on black style that complements many styling directions and budgets. An internal reinforcement system maintains the bag's shape over time. The "MOLLE-style" system of mounting loops accommodates hook and loop straps and allows for multiple mounting locations and orientations. The bags feature matte black enamel buckles with hidden quick-detach buckles underneath. These Throw-Over Bags feature side gussets for increased capacity and straight and perpendicular mounting loops for easy mounting. Quick-release buckles get you in and out of the bag fast. These Throw-Over Bags can be used with or without a passenger pillion. If used with a passenger pillion, the straps should be mounted under the pillion and the crossover straps feature a soft, non-scratch backing. Installation requires purchase of Saddlebag Support rails and may require the purchase of a Turn Signal Relocation Kit. Large bag measures: 16.5" L x 11.5" H x 7" D. Internal capacity: 1,350CI. Weight capacity: 10 lbs/bag. Compact bag measures: 10" L x 11.5" H x 5.25" D. Internal capacity: 600CI. Weight capacity: 6 lbs/bag.

Fits '82-'22 XL (except XL1200T), '08-'17 Dyna® (except FLD), '84-'99 Softail®, and '18-later Softail models equipped with H-D® Saddlebag Supports. '18-later Softail models require purchase of Turn Signal Relocation Kit P/N 67800802 or 68700830.

90201770	Large.	\$295.95
90201769	Compact.	\$242.95



A RIGID LEATHER LOCKING SADDLEBAGS



B. BLACK STANDARD LINE THROW-OVER SADDLEBAGS – LARGE



B. BLACK STANDARD LINE THROW-OVER SADDLEBAGS – COMPACT

NOTE: Some Harley-Davidson® saddlebags are made of leather. Fine leathers or other natural materials WILL gain "character," such as wrinkles or wear, with age. This is normal. A fine, aged patina and character wrinkles are a sign of the extremely high-quality materials used to construct your saddlebags. The appearance of scars or marks on the leather are a result of using natural leather panels and should not be thought of as an imperfection. Please use Harley-Davidson® Leather Protectant P/N 93600034 to protect your investment.

Notice: The prices appearing in this catalog are the manufacturer's suggested retail prices. Actual retail prices may vary.

CRUISER 71

Secondary Page Head

C. SADDLEBAG SUPPORTS

Keep your throw over-style saddlebags away from the wheel, swingarm and brake caliper. Can be installed on models equipped with rigid-mount sissy bar sideplates and uprights.

90201324 Chrome. **\$110.95**
Fits '00-'22 XL models (except XL1200S, XL1200T and '02-'03 XL883R). Does not fit with H-D® Detachables™ accessories.

90201433 Gloss Black. **\$110.95**
Fits '00-'22 XL models (except XL1200S, XL1200T and '02-'03 XL883R). Does not fit with H-D Detachables accessories.

D. SINGLE-SIDED SWINGARM BAG

These bags are constructed of heavyweight leather and feature a pouch-style flap lid that is secured with two quick-disconnect clips. The semi rigid-backed bag is secured to the left side of the bike with easy-to-install brackets and adjustable straps. Luggage capacity: 430 cubic inches total.

90201326A Black Leather. **\$230.95**
Fits '04-'22 XL models equipped with Solo Seats. Does not fit XL1200T. Requires removal of passenger pegs.

E. H-D® DETACHABLES™ SOLO TOUR-PAK MOUNTING RACK**

The rack is designed to position the Tour-Pak for solo riding. Tour-Pak, Passenger Backrest Pad and Docking Hardware sold separately.

53655-04A **\$155.95**
Fits '04-'22 XL models equipped with solo seat (except XL883N, XL1200C, XL1200CX, XL1200N). Designed to accept Color-Matched Sport Tour-Pak P/N 53929-YYXXX, Leather Tour-Pak P/N 53151-00A, 53147-98B, 53018-04A or 53690-06A. Requires separate purchase of appropriate Docking Hardware.



C. SADDLEBAG SUPPORTS – CHROME



C. SADDLEBAG SUPPORTS – GLOSS BLACK



D. SINGLE-SIDED SWINGARM BAG – BLACK LEATHER



E. H-D DETACHABLES SOLO TOUR-PAK MOUNTING RACK



****WARNING:** Do not use this rack as a seat. Do not exceed the fender rack weight capacity. Using as seat or exceeding this capacity could cause handling problems, which could result in loss of control and death or serious injury.

Notice: The prices appearing in this catalog are the manufacturer's suggested retail prices. Actual retail prices may vary.

SPORTSTER

72 CRUISER

Foot Controls

A. PASSENGER FOOTPEG MOUNT KIT – BLACK

Kit includes black mounting brackets, Original Equipment-style footpegs and all necessary mounting hardware.

50500270 **\$124.95**
Fits '14-'22 XL models.

50203-04 **\$124.95**
Fits '04-'13 XL models.

B. ADJUSTABLE PASSENGER FOOTPEG MOUNT KIT

Easy to adjust with common tools, the mount adjusts through a 360° range (depending on model), allowing both fore and aft and up and down height adjustment. Kit includes left and right adjustable support assembly and all required mounting hardware. Footpegs sold separately.

50763-09 **\$160.95**
Fits models with H-D® male mount-style passenger footpeg supports (except Softail® models). Does not fit with Heel Raiser Footpeg Kit P/N 50178-09. Does not fit the rider position.

C. MINI FOOTBOARD KIT

This footboard kit can be installed in place of traditional footpegs and provides a little additional leg support and more options to move your legs around on a long ride. Mini Footboards mount to the standard H-D® style footpeg supports and can be used in many rider, passenger and high-way peg applications.

Fits rider position:

'02-'17 VRSC™ models with forward controls (except VRSCDX and VRSCF), '15-'20 XG models (except XG750A), '06-earlier XL, '07-'10 XL883, XL883R, XL883C, XL1200C and XL1200R and '07-'11 XL1200L, '91-'17 Dyna® (except FLD) and '84-'17 Softail models with forward controls (except FXCW, FXCWC, FXS, FXSB or FXSBSE).

Fits passenger position:

All models with H-D male-mount passenger peg mounts (except '06-earlier VRSC, '03-earlier XL, '05-earlier Dyna and Softail models equipped with Shotgun exhaust). '84-'17 Softail models require separate purchase of Support Kit P/N 50454-09. Does not fit passenger position on '18-later Softail models.

Fits highway peg position:

All models with frame-mount or engine guard-mount highway pegs (except Whiskers Adjustable Highway Bar P/N 50855-09 and 50865-09).

50500139	Small 3.0" – Chrome.	\$139.95
50500144	Small 3.0" – Gloss Black.	\$139.95
50500109	Large 4.0" – Chrome.	\$139.95
50500124	Large 4.0" – Gloss Black.	\$139.95

D. ADJUSTABLE HIGHWAY PEG SUPPORT KIT*

So you're not the average Sportster® motorcycle rider. But then again, there is nothing average about Harley-Davidson. These chrome-plated Highway Peg Supports adjust easily and quickly into three height-accommodating positions. Use with your choice of H-D® small male mount-style footpegs (not included). Includes all necessary hardware.

49053-04A **\$213.95**
Fits '04-'22 XL models with mid controls (except XL1200C).



A. PASSENGER FOOTPEG MOUNT KIT – BLACK



B. ADJUSTABLE PASSENGER FOOTPEG MOUNT KIT



C. MINI FOOTBOARD KIT



D. ADJUSTABLE HIGHWAY PEG SUPPORT KIT

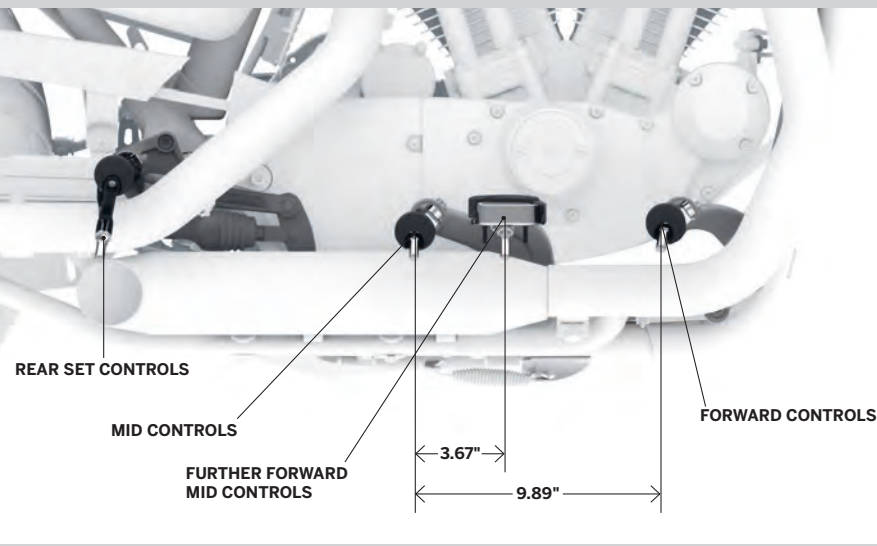

FOOT CONTROL POSITION OPTIONS



E. STANDARD FORWARD CONTROL KIT – CHROME (50700020 SHOWN)



E. STANDARD FORWARD CONTROL KIT – BLACK (33397-07A SHOWN)



F. FURTHER FORWARD MID CONTROL KIT – GLOSS BLACK



G. REAR SET FOOT CONTROLS – SPORTSTER MODELS

CRUISER 73

Foot Controls

SPORTSTER® FOOT CONTROLS

A long stretch to the controls or a knees-high cramped riding position puts strain on your body after even a short ride. Repositioning your feet on the controls relieves muscle tension, takes pressure off the tailbone, and reduces rider fatigue. Where your feet contact the controls can often determine how many miles you can put on in a day.

Many Sportster® models can be equipped with the following foot control configurations:

MID CONTROLS:

Original Equipment on some models, Mid Controls position the feet below the knee for a sporting riding posture.

STANDARD FORWARD CONTROLS:

Places the legs for a "feet-in-the-wind" laid-back profiling posture.

FURTHER FORWARD MID CONTROLS:

Achieves a comfortable foot-down riding position for the taller rider.

E. STANDARD FORWARD CONTROL KIT*

Add the stretched-out look and extended riding position to your Sportster model. The complete kit includes all hardware necessary to convert your Sportster model from mid controls to forward controls. Available in your choice of finishes, these forward controls add style and long range comfort. (Footpegs and shifter peg not included.)

Fits '14-'22 XL models. Requires separate purchase of stock or accessory rider position footpegs with wear pegs that fit '14-'22 XL1200 models.

50700020	Chrome with Black Peg Bracket.	\$524.95
50700021	Black.	\$478.95

Fits '06-'13 XL models with mid-controls (except XL1200CP and XL1200CA). XL1200L requires separate purchase of footpegs P/N 33134-07CAZ and 33135-07CAZ.

33395-06A	Chrome.	\$524.95
33397-07A	Black.	\$499.95

F. FURTHER FORWARD MID CONTROL KIT

Feel a little cramped when your feet are placed on the standard-location mid controls? This kit repositions the controls 3.0" forward of the stock location, eliminating the "knees-high" riding attitude while maintaining a sporty upright riding posture. The forward location provides an open path for your feet to aid maneuvering the bike while parking and improves access to the jiffy stand for a shorter rider. Kit includes control mounts, brake and shift levers, brake rod, mini-footboards with wear pegs and all hardware necessary to convert your mid or forward control-equipped Sportster model.

50700028 Gloss Black. **\$504.95**
Fits '14-'22 XL models.

G. REAR SET FOOT CONTROLS – SPORTSTER MODELS

Transform the on-street profile of your Sportster model. Moving the foot controls to a rear-mounted location takes the riding position from a relaxed cruiser to a solo, aggressive, curve-carving posture. When combined with a Clip-On or Clubman Handlebar, the resulting hands-forward and feet-back profile drapes the rider over the bike and makes you feel a part of the machine. This complete gloss black Rear Set Control Kit includes everything you need to move the brake and shift lever to the rear passenger position. This unique kit maintains the standard 1-down and 4-up shift pattern, and can be installed with the Original Equipment low staggered exhaust system. Kit reuses Original Equipment rider footpegs. Installation requires removal of passenger footpegs and footpeg mounts. For solo rider application only.

50700040 Gloss Black. **\$778.95**
Fits '14-'22 XL883N, XL883L, XL1200CX, XL1200T, and XL1200X models and '18-'22 XL1200NS and XL1200XS models. Does not fit with Rail Collection Sprocket Cover P/N 34800032. For use with solo seat application only. Installation of Rear Set Controls requires removal of passenger foot pegs, therefore removal of the Original Equipment two-up seat and installation of a solo-only seat is required. See your Dealer for solo seat options.



***WARNING:** Do not use highway pegs under normal stop and go operating conditions. Doing so could result in death or serious injury.



***WARNING:** Installation of accessory Forward Control Kits may affect cornering clearance. This could distract the rider, causing loss of control, resulting in death or serious injury.

Notice: The prices appearing in this catalog are the manufacturer's suggested retail prices. Actual retail prices may vary.

Notice: The prices appearing in this catalog are the manufacturer's suggested retail prices. Actual retail prices may vary.

74 CRUISER

Engine Guards

A. ENGINE GUARD*

The unique soft curve shape adds style to function. The one-piece Engine Guard is designed to complement the lines of the Sportster® motorcycle and the choice of finishes adds the perfect finishing touch. Add your choice of Engine Guard Mounted Highway Pegs (sold separately) to change your foot position on a long ride.

Fits '04-'22 XL and XR models (except XL1200CX, XL1200T, '16-'22 XL1200X, '18-'20 XL1200XS and '11-'20 XL883L). Will not fit with Front Spoilers.

49060-04	Chrome.	\$235.95
49215-07	Gloss Black.	\$235.95

Fits '11-'20 XL883L and '14-'22 XL1200T '20-models. Will not fit with Front Spoilers.

49287-11	Chrome.	\$235.95
-----------------	---------	-----------------

Also available: (not shown)

ENGINE GUARD*

This highly-polished, chrome-plated guard matches stock plating and works great with the Sportster Forward Controls.

49018-88C	Chrome.	\$235.95
------------------	---------	-----------------

Fits '82-'03 XL models. '82-early '84 models require Bracket P/N 49014-85. Will not fit with Front Spoilers.



A. ENGINE GUARD – CHROME



A. ENGINE GUARD – GLOSS BLACK



B. MUSTACHE ENGINE GUARD – CHROME



B. MUSTACHE ENGINE GUARD – GLOSS BLACK



C. SOFT LOWERS



D. PREMIUM RIDE EMULSION SHOCKS

C. SOFT LOWERS

Extend your riding season. Full coverage Soft Lower provide wind and mud protection for the rider's legs and boots and minimize cold updrafts as the weather changes. Covers are custom shaped to hug the engine guard to minimize flapping and they clip in place for speedy installation as the weather changes. Two-way zippered outer edge accommodates guard-mounted highway pegs in almost any position. Reflective piping provides added visibility and convenient zippered pockets provide additional storage for maps or other small items.

57100211		\$102.95
-----------------	--	-----------------

Fits '04-'22 XL models (except '11-'22 XL883L, XL1200CX, XL1200T, '16-'22 XL1200X and '18-'20 XL1200XS) equipped with Engine Guard P/N 49060-04 or 49215-07. Does not fit Mustache Engine Guards.

D. PREMIUM RIDE EMULSION SHOCKS*

These fast shocks offer enhanced compression and rebound damping control when compared to typical twin-tube shock absorbers. The nitrogen gas charged shocks resist oil aeration and work with the internal valve stack to provide superior damping control in the twisties. The large pistons and low viscosity high-performance oil allow these shocks to react quickly to impacts and keep the tires tracking the road surface. With the addition of urethane bumpers, you get a controlled ride and minimized bottoming harshness. Kit includes left and right shock and preload adjustment spanner wrench.

54000077	Low-Profile.	\$638.95
-----------------	--------------	-----------------

Fits '04-'15 XL models (except XL883, XL883R, XL1200R and XL1200T).



***WARNING:** Engine guards may provide limited leg and cosmetic vehicle protection under unique circumstances (fall over while stopped, very low speed slide). They are not made nor intended to provide protection from bodily injury in a collision with another vehicle or any other object.



***WARNING:** Do not use engine guard footpegs under normal stop and go operating conditions. Doing so could result in death or serious injury.



***WARNING:** Installation of any accessory suspension components may affect cornering clearance and jiffy stand operation. This could distract the rider, causing loss of control and death or serious injury.

Notice: The prices appearing in this catalog are the manufacturer's suggested retail prices. Actual retail prices may vary.

CRUISER 75

Front Axle Nut Covers

E. CUSTOM GEAR SHIFT LINKAGE – BLACK ANODIZED SLOTTED.

Kick your custom into gear with this collection of high-quality Custom Shift Linkages. Available in a variety of designs to match your bike's style, these linkages feature aircraft quality rod ends for easy adjustment and smooth operation. The easy-to-install linkage kit includes a transmission cover and decorative acorn nuts and bolts for a complete custom look.

Fits '04-'22 XL models equipped with standard forward controls.

2. 33778-09	Black Anodized Slotted.	\$118.95
--------------------	-------------------------	-----------------

F. FRONT AXLE NUT COVERS

Cover the front axle in style. Available in your choice of styles, these custom Axle Nut Covers look great with Original Equipment satin-finish fork sliders or add the finishing touch to a complete chrome or blacked-out front end. Easy to install kits include all necessary mounting hardware. Sold in pairs.

Fits '02-'11 VRSC™ (except VRSCF and VRSCR), '15-'20 XG, '08-'22 XL, '08-'17 Dyna®, '07-later Softail® (except Heritage Springer™, FLSTNSE, FXCW, FXCWC, FXSB, FXSBSE, FXSE, FXST-Aus, and FXSTD) and '08-later Touring and Trike models. '18-later FLDE, FLFB, FLFBS, FLHC, FLHCS, FLSB, FLFL, FXBB, FXBBS, FXBR, FXBRS and FXLR models require separate purchase of Front Axle Adapter Kit P/N 43000090. '19-'20 FXDRS, '18-later FXFB and FXFBS and '20-later FXLRS and FXLRST models, require separate purchase of Front Axle Adapter Kit P/N 43000159.

1. 43000212	Machine Cut.	\$65.95
2. 43000124	Dominion – Gloss Black.	\$79.95
3. 43000123	Dominion – Bronze.	\$79.95
4. 44117-07A	Chrome – Die-cast.	\$33.95
44116-07A	Chrome – Billet.	\$53.95
5. 43000026	Gloss Black – Die-cast.	\$33.95
43428-09	Gloss Black – Billet.	\$53.95
6. 43000177	H-D Motor Co. – Black.	\$35.95
7. 44148-07A	H-D Motor Co. – Chrome.	\$35.95
8. 44114-07	Aluminator.	\$53.95

Also available:

Willie G Skull

Fits '02-'11 VRSC (except VRSCF and VRSCR), '15-'20 XG, '08-'22 XL (except '16-'22 XL1200X and XL1200XS), '08-'17 Dyna, '07-later Softail (except Heritage Springer, FLSTNSE, FXCW, FXCWC, FXSB, FXSBSE, FXSE, FXST-Aus, and FXSTD) and '08-later Touring and Trike models. '18-later FLDE, FLFB, FLFBS, FLHC, FLHCS, FLSL, FXBB, FXBBS, FXBR, FXBRS, FXLR and FXST models require separate purchase of Front Axle Adapter Kit P/N 43000090. '19-'20 FXDRS, '18-later FLSB, FXFB and FXFBS and '20-later FXLRS and FXLRST models require separate purchase of Front Axle Adapter Kit P/N 43000159.

9. 43000096	Black.	\$38.95
10. 43163-08A	Chrome.	\$38.95

Brass Collection

11. 43000046		\$64.95
---------------------	--	----------------

Fits '02-'11 VRSC (except VRSCF and VRSCR), '15-'20 XG, '08-'22 XL (except '16-'22 XL1200X and XL1200XS), '08-'17 Dyna, '07-later Softail (except Heritage Springer, FLSTNSE, FLSB, FXCW, FXCWC, FXDRS, FXFB, FXFBS, FXLRS, FXSB, FXSBSE, FXSE, FXST-Aus, and FXSTD) and '08-later Touring and Trike models. '18-later FLDE, FLFB, FLFBS, FLHC, FLHCS, FLSL, FXBB, FXBBS, FXBR, FXBRS, FXLR and FXST models require separate purchase of Front Axle Adapter Kit P/N 43000090. '19-'20 FXDRS, '18-later FLSB, FXFB and FXFBS and '20-later FXLRS and FXLRST models require separate purchase of Front Axle Adapter Kit P/N 43000159.

Also available: (not shown)

Fits '88-'07 XL, '91-'03 FXD, FXDX, FXDXT, FXDL, FXDSCONV, '93-'05 FXDWG, '88-'07 FXR, '87-later FLXR, FXRS-SP and FXWG, '84-'06 Softail (except Heritage Springer and FXSTD) and '80-'99 Touring models.

43899-86A	Chrome – Die-cast.	\$33.95
------------------	--------------------	----------------



E. CUSTOM GEAR SHIFT LINKAGE – BLACK ANODIZED SLOTTED.



F. FRONT AXLE NUT COVERS

Notice: The prices appearing in this catalog are the manufacturer's suggested retail prices. Actual retail prices may vary.

SPORTSTER

76 CRUISER

Chassis Trim — Front End

A. DOMINION™ COLLECTION FORK STEM COVERS

Top it off with style. These easy-to-install Fork Stem Covers top off the triple tree for a cohesive look. A perfect complement to other Dominion™ Collection Accessories, these Fork Nut Covers provide the finishing touch to your bike's front end. Sold in pairs.

Fits '06-'17 Dyna® models (except FXDB and FXDSE) and '18-later Softail® models (except FXDRS, FXFB, FXFBS, FXLRS, and FL5B). Also fits '88-'13 XL (except XL1200CX, XL1200X, XL883N) '95-'05 FXD, '93-'05 FXDL, '16-'17 FXDLS, '94-'05 FXDS-CONV, '90-'17 FLS, FLSS, FLSTF, FLSTFB, FLSTFBS and FLSTN, and '86-'17 FLSTC models.

45800117 Gloss Black. **\$79.95**



A. DOMINION COLLECTION FORK STEM COVERS – GLOSS BLACK



B. DEFIANCE COLLECTION UPPER FORK STEM COVERS – CHROME



B. DEFIANCE COLLECTION UPPER FORK STEM COVERS – GLOSS BLACK

B. DEFIANCE COLLECTION UPPER FORK STEM COVERS

Top it off with style. These easy-to-install Fork Stem Covers continue the Defiance Collection to the top of the triple tree for a cohesive look. The deep radial grooves define the style of the Defiance Collection, and the choice of chrome, black or machine cut finishes complement your bike's polished, chrome or blacked-out front end components. Sold in pairs.

Fits '06-'17 Dyna models and '18-later Softail models (except FXDRS, FXFB, FXFBS, FXLRS, FXLRST and FL5B). Also fits '88-'13 XL (except XL1200CX, XL1200X, XL883N) '95-'05 FXD, '93-'05 FXDL, '16-'17 FXDLS, '94-'05 FXDS-CONV and '90-'17 FLS, FLSS, FLSTF, FLSTFB, FLSTFBS and FLSTN and '86-'17 FLSTC models.

45500514 Chrome. **\$54.95**

45500515 Gloss Black. **\$55.95**

C. BAR & SHIELD LOGO REAR AXLE COVERS

Die-cast cover conceals the side of the swingarm and axle. Unique styling features an embossed Bar & Shield logo. Easy to install without removing the rear wheel. Kit includes all necessary mounting hardware.

Fits '05-'22 XL883C, XL883L, XL883N, XL1200C, XL1200CX, XL1200L, XL1200N, XL1200NS, XL1200V, XL1200X and XL1200XS models. Also fits '05-'22 XL models equipped with Low Rear Suspension Kit P/N 54731-04, 54733-04 or 54750-05. (Will not fit models equipped with saddlebags or Chrome Billet Shock Hardware Kit P/N 54337-05.)

46399-05A Chrome. **\$59.95**

43013-09A Gloss Black. **\$59.95**



C. BAR & SHIELD LOGO REAR AXLE COVERS – CHROME



C. BAR & SHIELD LOGO REAR AXLE COVERS – GLOSS BLACK

D. SHOCK BOLT COVERS

It's the details that complete the look of your bike. These Shock Bolt Covers are designed to hide the upper shock mounting hardware and provide a custom look to the rear of your bike. Easy to install, the kit includes left and right bolt covers and all required mounting hardware.

Fits '04-'16 XL and '06-'17 Dyna models (except FLD, FXDF, FXDL and FXDLS). Does not fit with H-D® Detachables™ Leather Saddlebag Kit P/N 90181-08A.

54000016 Chrome. **\$43.95**

54000017 Gloss Black. **\$43.95**



D. SHOCK BOLT COVERS – CHROME



D. SHOCK BOLT COVERS – GLOSS BLACK



E. SWINGARM – CHROME



F. BUCKSHOT UPPER BELT GUARD – GLOSS BLACK



G. BUCKSHOT LOWER BELT GUARD – GLOSS BLACK

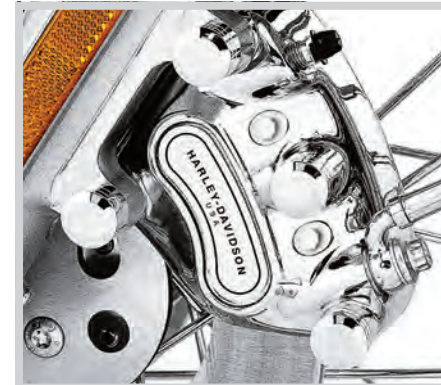

H. BRAKE CALIPER KIT – CHROME (44395-00A SHOWN)



I. SPROCKET HARDWARE – CHROME HEX HEAD



J. REAR SPROCKET BOLT COVER KIT

These chrome-plated covers with internal spring clips hide the Original Equipment sprocket bolts for a clean, custom look. Set of 5 covers.

43876-04 Fits '04-'22 XL, '93-'17 Softail and '99-later Touring models with Original Equipment 7/16" hex head sprocket mounting bolts (5/8" hex across the flats). **\$46.95**



J. REAR SPROCKET BOLT COVER KIT

77 CRUISER

Chassis Trim — Rear End

E. SWINGARM – CHROME

The ultimate chrome accessory, polished to the highest standard using bright plating to match Original Equipment chrome. Affordable and convenient, with no troublesome exchanges necessary. Factory specifications guarantee exact fitment, unparalleled quality and an affordable price. Stamped with the Harley-Davidson Bar & Shield logo.

48434-05A Fits '05-'22 XL models (except XL1200T). **\$266.95**

F. BUCKSHOT UPPER BELT GUARD – GLOSS BLACK

Add the blacked-out look of the Nightster® motorcycle to your Sportster® model. The perforated Buckshot design visually lightens the belt guard and adds a raw, purposeful edge to the bike's profile.

60300196 Fits '04-'22 XL models. **\$119.95**

G. BUCKSHOT LOWER BELT GUARD – GLOSS BLACK

This handsome gloss black steel guard replaces the Original Equipment plastic debris deflector to provide a rich smooth surface that complements the upper belt guard and swingarm. The perforated Buckshot design adds an open look while protecting the belt from stones and debris.

57100297 Fits '04-'22 XL models. **\$116.95**

H. BRAKE CALIPER KIT – CHROME

Add the shine of chrome to your front end with this highly polished Chrome Front Brake Caliper Kit. Manufactured from Original Equipment components for proven performance, these calipers are a great addition to the stock front end or they add the finishing touch to a complete custom with chrome wheels, rotors and chrome fork sliders.

44395-00A Front – Single Disc. **\$419.95**

Fits '00-'03 XL, '00-'07 Dyna® and '00-'07 Softail® models (except Springer) equipped with single disc front brakes. Brake pads sold separately.

I. SPROCKET HARDWARE – CHROME HEX HEAD

This kit includes highly polished, chrome-plated, grade 8 hex-head screws with chrome-plated washers, providing an extra custom accent. The perfect addition to the chrome sprocket. Made from the same Original Equipment bolts to ensure product integrity. Also works with chrome belt sprocket covers and Original Equipment sprockets.

94708-98 Fits '91-'22 XL and '93-'99 Dyna and Softail models. **\$36.95**

J. REAR SPROCKET BOLT COVER KIT

These chrome-plated covers with internal spring clips hide the Original Equipment sprocket bolts for a clean, custom look. Set of 5 covers.

43876-04 Fits '04-'22 XL, '93-'17 Softail and '99-later Touring models with Original Equipment 7/16" hex head sprocket mounting bolts (5/8" hex across the flats). **\$46.95**

78 CRUISER

Oil Cooler & Gauges

A. PREMIUM OIL COOLER KIT

This oil cooler was designed specifically for Harley-Davidson to out-perform all other coolers in the industry. The cooler features a unique "Turbulator" system that evenly distributes oil across the cooling chambers. The air fins are designed to efficiently dissipate heat. The oil cooler has been designed to simplify installation and enhance performance. Kit comes complete with mounting hardware and precut oil lines.

62700082 Side-Mount. **\$405.95**
Fits '04-'22 XL models. Does not include an integrated thermostat.

B. COMBINATION DIGITAL SPEEDOMETER/ANALOG TACHOMETER – 4"

Maintain the clean view over the handlebar. This unique Combination Speedometer/Tachometer allows you to monitor engine speed without additional handlebar-mounted gauges. The unit mounts in the stock dash opening and is a direct plug-in installation. The backlit gauges include a large LCD (liquid crystal display) information screen that displays odometer/tripmeter data, miles-to-empty readings, an easy-to-read segmented fuel display, a gear position indicator and clock. This valuable information is available to the rider at a glance. The gauge features push-button adjustable backlighting with over 600 color tone options, allowing the rider to adjust pointer, LCD and backlighting colors to match any paint scheme or viewing preference. The digital speed reading can be easily toggled between mph and kph to simplify cross-border travel. Mileage reinstatement resides in the vehicle ECM so initial mileage will be uploaded at the time of installation.

NOTE: As a result of different vehicle capabilities, the following exceptions apply: Gear position not available on '04-'07 models, range function not available on '04-'06 XL models and '04-'08 Dyna® models, fuel level function not available on '04-'06 XL models.

70900475 Spun Aluminum Dial, MPH/km/h **\$351.95**
U.S. models. Fits '14-'22 XL, '12-'17 Dyna and '11-'17 Softail® models equipped with 4" speedometer. XL models require separate purchase of Fuel Sensor Kit P/N 61200008A to make use of the fuel level and range function.

70900100C Spun Aluminum Dial, MPH/km/h **\$342.95**
Non-U.S. models. Fits '14-'22 XL, '12-'17 FXDB and FXDWG, '11-'17 FXCWC, FXS and FXSB models with 4" speedometer. XL models require separate purchase of Fuel Sensor Kit P/N 61200008A for fuel level and range function.

70900274 Spun Aluminum Dial, MPH/km/h **\$342.95**
Worldwide Models. Fits '04-'13 XL (except XR, XL50 and '04-'08 XL1200R), '04-'11 Dyna models with 4" speedometer and '08-'10 FXCW and FXCWC models. '07-'13 XL models require separate purchase of Fuel Sensor Kit P/N 61200008A to make use of the fuel level and range function. Does not fit XL883 models equipped with Screamin' Eagle® 1200cc Stage I Conversion Kit P/N 29784-07 and 30003-10.

C. SPORTSTER® FUEL GAUGE KIT*

Keep an eye on your Sportster® model fuel level without watching how many miles you have traveled. In-tank sending unit employs capacitive sensing technology to accurately monitor the fuel level and relays the information to a handlebar-mounted LED indicator for at-a-glance viewing. The segmented LED display is set into a distinctive housing that replaces the brake master cylinder cover on the right hand control. The individual LED segments glow when the tank is full and count down one by one as the fuel level drops. Kit includes sending unit, LED master cylinder cover, wiring harness and all necessary installation hardware.

75031-09 Black. **\$319.95**
Fits '07-'22 XL and '08-'13 XR models. '14-'22 XL models require separate purchase of Electrical Connection Kit 72673-11.

*Some local regulations prohibit using colored lights during vehicle operation on public streets. May not conform to local lighting regulations.



A. PREMIUM OIL COOLER KIT



B. COMBINATION DIGITAL SPEEDOMETER/ANALOG TACHOMETER – 4"



C. SPORTSTER FUEL GAUGE KIT – BLACK



D. OIL LEVEL AND TEMPERATURE DIPSTICK WITH LIGHTED LCD READOUT – CHROME



E. OIL DIPSTICK WITH TEMPERATURE GAUGE – '04-LATER SPORTSTER



F. DIPSTICK BEZEL – GLOSS BLACK



G. OIL TANK COVER



D. OIL LEVEL AND TEMPERATURE DIPSTICK WITH LIGHTED LCD READOUT – GLOSS BLACK



E. OIL DIPSTICK WITH TEMPERATURE GAUGE – '82-'03 SPORTSTER



G. BATTERY COVER

CRUISER 79

Chassis Trim

D. OIL LEVEL AND TEMPERATURE DIPSTICK WITH LIGHTED LCD READOUT

New and improved capacitive level sensing technology provides the highest degree of accuracy and durability. Now available in chrome and black, these dipsticks allow you to check your oil level and oil temperature with the push of a button. Add function and style by replacing your stock dipstick with this hardworking version. No more grabbing a rag to pull your hot dipstick. No more oil drips on your pipes and on the garage floor. These stylish yet hard-working dipsticks allow you to check your oil level and oil temperature with the push of a button. Simply push the button and this dipstick lights up with a brilliant backlight. Oil level is indicated by a four-segment readout – it even reminds you to check your oil when it is hot. Capacitive level sensing technology provides the highest degree of accuracy and durability. The waterproof LCD (liquid crystal display) readout operates on a long-lasting, replaceable lithium coin-type battery (P/N 91800066). Display features a low battery indicator and press-and-hold feature to toggle between Fahrenheit and Celsius.

Fits '04-'22 XL and XR models.

62700009	Chrome.	\$164.95
62700011	Gloss Black.	\$164.95

E. OIL DIPSTICK WITH TEMPERATURE GAUGE

Replace your Original Equipment oil dipstick with this custom-styled version featuring an easy-to-see mechanical temperature readout with Harley-Davidson logo. A chrome-plated cap completes the styling and provides an easy grip for removal.

63023-05	Fits '04-'22 XL and XR models.	\$66.95
62667-87TA	Fits '82-'03 XL models.	\$45.95

F. DIPSTICK BEZEL – GLOSS BLACK

This gloss black Dipstick Bezel replaces the Original Equipment chrome or satin silver bezel and completes the blacked-out look of the Sportster® model's right side oil tank cover. This bezel complements the available Gloss Black LCD Oil Level and Temperature Dipstick P/N 62700011. Includes replacement push nut for installation.

57200159		\$23.95
Fits '04-'22 XL models.		

G. CUT BACK SIDE COVERS

Instantly transform the profile of your Sportster motorcycle. These Cut Back Side Covers feature a unique two-piece design with a cutaway, technical look. The combination of gloss black and textured black surfaces visually reduces the size of the side covers, and the raised "speed lines" impart a sense of forward motion. The side covers feature improved mounting tabs for easy and secure installation. Right-side oil tank cover features a gloss black dipstick surround to add to the blacked-out look. Oil Tank Cover and Battery Cover are sold individually.

Fits '14-'22 XL models.

57200139	Oil Tank Cover.	\$160.95
57200140	Battery Cover.	\$160.95

80 CRUISER

Chassis Trim

A. FUEL TANK TRIM PANEL KIT – CHROME

Set your fuel tank apart from the rest with this mirror chrome Fuel Tank Trim Panel. Fits around the stock fuel cap and is adhesive backed.

61653-04 **\$134.95**

Fits '04-'22 XL883C, XL1200C and XL1200L models. Also fits '04-'22 XL models equipped with a Sportster® Large Capacity Fuel Tank and Installation Kit P/N 62999-04 or 62999-07.



A. FUEL TANK TRIM PANEL KIT – CHROME

B. BATTERY SIDE COVER – CHROME

This chrome-plated cover is designed for use with the Harley-Davidson® AGM sealed maintenance-free batteries and can be used in combination with Battery Top Cover P/N 66367-97 or 66368-97.

66718-01 **\$54.95**

Fits '97-'03 XL models and '97-'05 Dyna® models.



B. BATTERY SIDE COVER – CHROME

C. LOUD HORN KIT

Grab everyone's attention. Engineered to be 3dB louder (at 2 meters) than the Original Equipment front-mounted horn, this Horn Kit is tuned to a frequency that helps cut through the background noise. Designed to be a plug-in replacement for the factory horn, this easy-to-install option is available in your choice of brilliant chrome or gloss black finish. The traditional Bar & Shield logo adds a classic finishing touch.

Fits '96-'22 XL and '08-'13 XR models with front-mount horn.

69000007 Chrome. **\$33.95**

69000009 Gloss Black. **\$33.95**

D. LOUD SIDE-MOUNT HORN KIT

Get noticed. Ride with increased confidence with a loud horn that will grab everyone's attention. Engineered to be 5dB louder (at 2 meters) than the '13-earlier Original Equipment side-mounted horn. The loud horn is stock on '14-later models equipped with side-mount horns. Designed to be a plug-in replacement that is easy to install. Fits all H-D® side-mount horn covers.

69060-90H **\$54.95**

Fits '91-'17 VRSC™, '91-'22 XL1200C and XL1200V, '91-'17 Dyna (except '14-'17 FXDL), '91-'17 Softail® (except FLSTS, FLSTSC, FXCW, FXCWC, FXS, FXSB and FXSBSE), '91-later Touring and '09-later Trike models. Stock on '14-later models equipped with a side-mount horn.



C. LOUD HORN KIT – CHROME



C. LOUD HORN KIT – GLOSS BLACK

E. SIDE-MOUNT HORN KIT – CHROME

Convert your stock Sportster horn to the look of a Big Twin.

69112-95E **\$112.95**

Fits '92-'22 XL883, XL883C, XL883H, XL883L, XL883N, XL833R, XL1200, XL1200L, XL1200N, XL1200NS, XL1200R, XL1200V, XL1200X and XL1200XS and '08-'13 XR models.



D. LOUD SIDE-MOUNT HORN KIT



E. SIDE-MOUNT HORN KIT – CHROME

CRUISER 81

Chassis Trim

G. DOMINION™ COLLECTION FUEL CAPS

Add a custom touch to your tank. Styled to reflect your attitude, these fuel caps are the perfect match for your ride. The fuel cap is easy to install and features a ratcheting design to ensure that the design faces the correct direction.

Fits '92-'22 XL, '92-'17 Dyna® (except '04-'17 FXD, FXDX, '05-'06 FXDC and '07 FXDSE), '00-later Softail® (except FXSTD, and '07-'08 FXSTSSE), '94-later Road King® and '15-later Freewheeler® models. Does not fit models equipped with Original Equipment locking or tethered fuel caps or Softail models with Low-Profile Chrome Fuel Tank Console P/N 71208-07. Use on '13-'14 FXSBSE requires removal of stock flush mount trim ring.

61100107A Gloss Black. **\$99.95**

61100106 Bronze. **\$107.95**



G. DOMINION FUEL CAP – GLOSS BLACK



G. DOMINION FUEL CAP – BRONZE

H. FLUSH-MOUNT FUEL CAPS

Emphasize the long and lean look of the fuel tank. This Flush-Mount Fuel Cap Kit offers a pop-up filler design that replaces the Original Equipment twist-on fuel cap. A simple push and the fuel filler cap pops up to provide ample grip, even while wearing gloves. Easy to install, the cap assembly screws into position and the self-adhesive decorative ring finishes the look. Complete kit includes screw-in mount, pop-up cap and matching trim ring.

Fits '98-'22 XL models equipped with 3.3 gal (12.5 L) fuel tank.

63133-10B Chrome. **\$84.95**

63134-10B Gloss Black. **\$84.95**

Fits '98-'22 XL models equipped with 2.1 gal (7.9 L) or 4.5 gal (17.0 L) fuel tank. Does not fit '04-'10 XL1200C models.

63139-10B Chrome. **\$84.95**

63140-10B Gloss Black. **\$84.95**



H. FLUSH-MOUNT FUEL CAP – CHROME



H. FLUSH-MOUNT FUEL CAP – GLOSS BLACK

Notice: The prices appearing in this catalog are the manufacturer's suggested retail prices. Actual retail prices may vary.

Notice: The prices appearing in this catalog are the manufacturer's suggested retail prices. Actual retail prices may vary.

SPORTSTER

82 CRUISER

Windshields

A. QUICK-RELEASE COMPACT WINDSHIELD

Combine the classic Harley-Davidson® windshield shape with a revolutionary new attachment system and you have the best of style and function. The windshield mounts to the fork tubes with elegant die-cast lever-release clamps, so the windshield does not require any leave-behind docking hardware. You get quick on-and-off convenience and a clean, custom look. No tools are required and the kit includes everything needed to install the windshield. The tough, hard-coated polycarbonate windshield is available in your choice of traditional polished or gloss black horizontal and vertical braces.

Fits '06-'17 Dyna® (except FLD, FXDWG, FXDF and FXDSE) and '18-later FXBB, FXBBS, FXLR and FXST models. FXDLS models require the removal of Original Equipment Wind Deflector.

58346-06 18" Clear – Polished Braces. **\$435.95**
Windshield dimensions: Overall height – 26.8"; width – 19.7".

58348-06 14" Light Smoke – Polished Braces. **\$440.95**
Windshield dimensions: Overall height – 22.8"; width – 19.5".

Fits '06-'17 FXDWG, '13-'17 FXSB and FXSBSE and '18-later FXBR and FXBRS models.

58387-06 18" Clear – Polished Braces. **\$411.95**
Windshield dimensions: Overall height – 26.8"; width – 19.5".

58444-06 14" Light Smoke – Polished Braces. **\$416.95**
Windshield dimensions: Overall height – 22.8"; width – 19.5".

Fits '08-'17 FXDF and FXDFSE models.

57338-08 19" Clear – Polished Braces. **\$440.95**
Windshield dimensions: Overall height – 27.0"; width – 19.6".

58617-09 19" Clear – Black Braces. **\$461.95**
Windshield dimensions: Overall height – 27.0"; width – 19.6".

58630-09 15" Light Smoke – Black Braces. **\$477.95**
Windshield dimensions: Overall height – 23.0"; width – 19.6".

Fits '88-'22 XL (except XL1200CX, XL1200T, XL1200X, XL1200XS and '11-'22 XL883L and XL1200C). XL1200NS requires removal of headlight visor. Also fits '91-'05 Dyna models (except FXDWG and FXDXT).

58063-04 18" Clear – Polished Braces. **\$427.95**
Windshield dimensions: Overall height – 26.8"; width – 19.7".

58706-09 18" Clear – Black Braces. **\$450.95**
Windshield dimensions: Overall height – 26.8"; width – 19.7".

58602-04 14" Light Smoke – Polished Braces. **\$435.95**
Windshield dimensions: Overall height – 22.8"; width – 19.5".

58703-09 14" Light Smoke – Black Braces. **\$456.95**
Windshield dimensions: Overall height – 22.8"; width – 19.5".

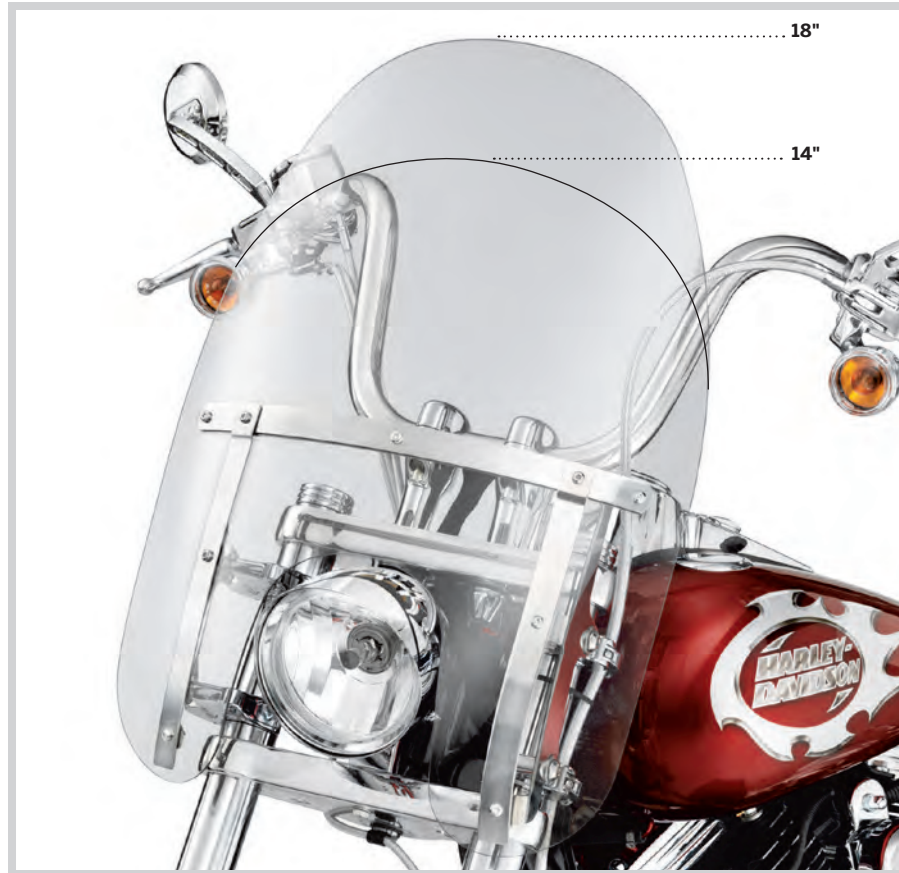

A. QUICK-RELEASE COMPACT WINDSHIELD – POLISHED BRACES



A. QUICK-RELEASE COMPACT WINDSHIELD – 15", GLOSS BLACK BRACES (SHOWN WITH TURN SIGNAL RELOCATION KIT)



B. QUICK-RELEASE SUPER SPORT WINDSHIELD (57300-06 SHOWN)



B. QUICK-RELEASE SUPER SPORT WINDSHIELD (57838-08 SHOWN)



C. H-D DETACHABLES TALL WINDSHIELD – SWITCHBACK

CRUISER 83

Windshields

B. QUICK-RELEASE SUPER SPORT WINDSHIELD

Reduces the pounding of wind and shower of bugs, but keeps the wind-in-the-hair feeling. Ideal for a cool morning ride, the sleek profile of the Super Sport Windshield hugs the fork tubes with elegant die-cast lever locking clamps, so the windshield does not require any leave-behind docking hardware. You get quick on-and-off convenience and a clean, custom look. No tools are required and the kit includes everything needed to install the windshield.

57300-06 19" Light Smoke. **\$406.95**
Fits '06-'17 Dyna® (except FLD, FXDWG, FXDF and FXDSE) and '18-later Softail® FXBB, FXBBS, FXLR and FXST models. FXDLS models require the removal of Original Equipment Wind Deflector. Windshield dimensions: Overall height-25.0"; width-20.1".

57301-06 19" Light Smoke. **\$406.95**
Fits '06-'17 FXDWG, '13-'17 FXSB and FXSBSE and '18-later FXBR and FXBRS models. Windshield dimensions: Overall height – 25.0"; width – 20.1".

57838-08 19" Light Smoke. **\$385.95**
Fits '88-'22 XL (except XL1200CX, XL1200T, XL1200X and '11-'22 XL883L and XL1200C) and '91-'05 Dyna models (except FXDWG and FXDXT). XL Custom models require Front Directional Relocation Kit P/N 68517-94A. Windshield dimensions: Overall height – 25.0"; width – 20.1".

C. H-D DETACHABLES TALL WINDSHIELD – SWITCHBACK™ MODEL

Get maximum protection from the wind. The detachable shield can be removed and reinstalled in seconds to tailor your bike to different riding conditions.

57400120 20" Clear. **\$391.95**
Fits '12-'16 FLD models. Windshield dimensions: Overall height – 27.0"; width – 24.0".

84 CRUISER

Windshields

A. H-D® DETACHABLES™ SUPER SPORT WINDSHIELD

Super is an apt description for this do-it-all windshield with detachable convenience and sport styling. The windshield mounts to the fork tubes with H-D® Detachables™ Docking Hardware (sold separately) for easy on-and-off convenience and a quick return to a sporting profile.

57965-97A 18" Light Smoke. **\$310.95**
Fits '93-'05 FXDWG, '80-'86 FXWG and '84-'15 FXST, FXSTB and FXSTC models. Use Docking Hardware Kit P/N 58350-96. Windshield dimensions: Overall height – 22.3"; width – 17.8".

Shown with:

DOCKING HARDWARE FOR H-D DETACHABLES WINDSHIELDS

58164-96A For 39mm Forks. **\$86.95**
Required for installation of H-D Detachables Windshields on '88-'22 XL (except XL1200CX, XL1200X, XL1200XS and '11-'22 XL1200C) and '91-'05 Dyna® models (except FXDWG and FXDXT). XL and Dyna models with Front Turn Signals originally located on the upper triple clamp may require the additional purchase of Turn Signal Wiring Kit P/N 72389-96.

58350-96 For 41mm Forks. **\$86.95**
Required for installation of H-D Detachables Windshields on '93-'05 FXDWG, '80-'86 FXWG and '84-'17 FXST, FXSTB and FXSTC models.

B. SPORT WINDSHIELD KIT

Formed of polycarbonate and hard-coated to resist scratching. Light smoke windshield is contoured to fit the headlamp and incorporates adjustable four-point mounting. Functional styling helps deflect wind to reduce upper body fatigue.

58192-87A 18" Light Smoke. **\$197.95**
Fits '88-'22 XL (except XL883C, XL1200C, XL1200CX, XL1200T, XL1200, XL1200XS and '11-'22 XL883L). XL1200NS requires removal of headlight visor. Also Fits '95-'05 Dyna models (except FXDWG and FXDXT). Includes black mounting hardware. Windshield dimensions: Overall height – 18.5"; width – 16.3".



A. H-D DETACHABLES SUPER SPORT WINDSHIELD



B. SPORT WINDSHIELD KIT



C. H-D DETACHABLES QUARTER FAIRING KIT – VIVID BLACK



D. HEADLAMP VISOR KIT – VIVID BLACK



E. MID-FRAME AIR DEFLECTOR (DYNA SWITCHBACK SHOWN)



F. SOFT LOWERS



F. SOFT LOWERS



F. SOFT LOWERS

CRUISER 85

Windshield Accessories

C. H-D® DETACHABLES™ QUARTER FAIRING KIT*

Sleek, racy styling and sweeping lines define this innovative fairing. The quarter fairing-sized detachable design gives your bike a whole new sporty look that can be changed in an instant. Available in primed or Vivid Black finish, the fairing is interchangeable with H-D® Detachables™ Windshields, giving you plenty of options for cruising or touring. Plus, the windshield has a two-position adjustment feature for flexibility.

Fits '88-'12 XL (except XL883C, XL883N, XL1200C, XL1200CX, XL1200T, XL1200V, XL1200X and '11-'22 XL883L), FXR and '95-'05 Dyna® models (except FXLR, FXDWG and FXDXT). Requires the installation of Docking Hardware Kit P/N 58164-96A.

57070-98	Primed.	\$336.95
57070-97DH	Vivid Black.	\$477.95

D. HEADLAMP VISOR KITS*

Add an element of racy style to stock headlamps with these visors. Available in Primed or Vivid Black Harley-Davidson® paint.

Fits '95-'22 XL (except XL883C, XL1200C, XL1200CX, XL1200V, XL1200X and XL1200XS), '95-'05 Dyna (except FXDXT and FXDWG) and '82-'94 FXR and FXRS models. Does not fit with Clip-On Handlebar P/N 55800647.

68129-97	Primed.	\$168.95
68129-98DH	Vivid Black.	\$308.95

E. MID-FRAME AIR DEFLECTOR

Improve rider comfort during the summer riding season. Designed for severe duty and extreme temperature applications, these inconspicuous black deflectors attach to the frame and surround the top of the rear cylinder head. The scoop shape captures the moving air and uses the flow to direct the heat down and away from the rider to improve comfort. Kit includes all required mounting hardware.

29200011 **\$97.95**
Fits '06-'17 Dyna models. '06-'11 models require removal of Original Equipment coil cover and separate purchase of Coil Mounting Screws P/N 4717A (Qty 2). Does not fit with accessory Coil Covers P/N 31709-04 or 74616-04. Does not fit with Digital Oil Pressure Gauge P/N 75138-09 or 75340-09.

F. SOFT LOWERS

Extend your riding season. Full coverage Soft Lower provide wind and mud protection for the rider's legs and boots and minimize cold updrafts as the weather changes. Covers are custom-shaped to hug the engine guard to minimize flapping and they simply clip in place for speedy installation as the weather changes. Two-way zippered outer edge accommodates guard-mounted highway pegs in almost any position. Reflective piping provides added visibility and convenient zippered pockets provide additional storage for maps or other small items.

57100212 **\$102.95**
Fits '06-'17 FXD, FXDB, FXDC and FXDL models equipped with Engine Guard P/N 49010-06 or 49320-09. Does not fit models with forward controls or footboards.

Notice: The prices appearing in this catalog are the manufacturer's suggested retail prices. Actual retail prices may vary.

*NOTE: This product is a "Paint to Order" accessory. Please allow for an average of 5 weeks' delivery for this item.
Notice: The prices appearing in this catalog are the manufacturer's suggested retail prices. Actual retail prices may vary.

DYNA

Seating – Reach® & Tallboy®

ENJOY THE RIDE

The relationship between the seat, the handlebar and the foot controls has an enormous impact on the comfort, control and confidence you feel when riding your motorcycle. Once you've picked the bike, it's time to choose the options that match your ride to your personal dimensions.



For shorter riders, consider tailoring your fit by changing to a Reach® Seat, Mid Foot Controls and lowered suspension height.



For taller riders, consider altering your ride by changing to a Tallboy® Seat and Extended Foot Controls.

ESTABLISH YOUR POSITION AND FEEL

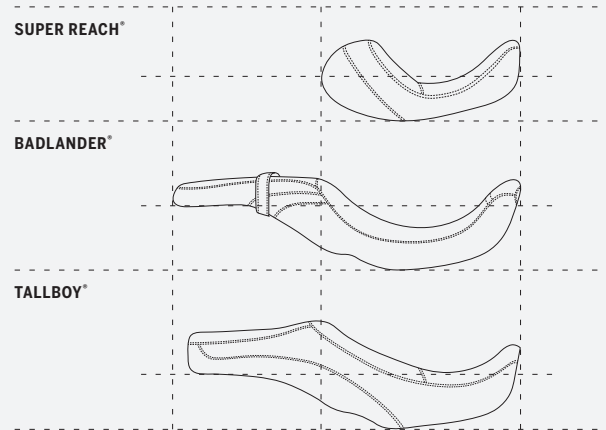

SEATS

Seat height and shape impact rider comfort, fit and confidence. Where the seat positions you relative to the foot controls, hand controls and the ground plays a major role in the quality of your ride.

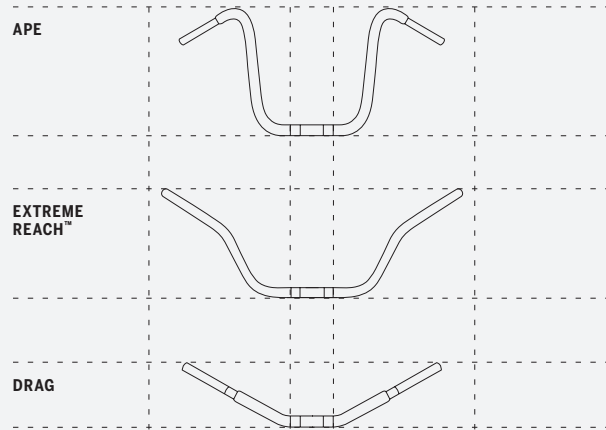

HANDLEBARS

Where the bar positions your arms, hands and wrists directly impacts how you feel on the motorcycle. Choose a bar that falls easily to hand, and does not pull you out of the seat when maneuvering.

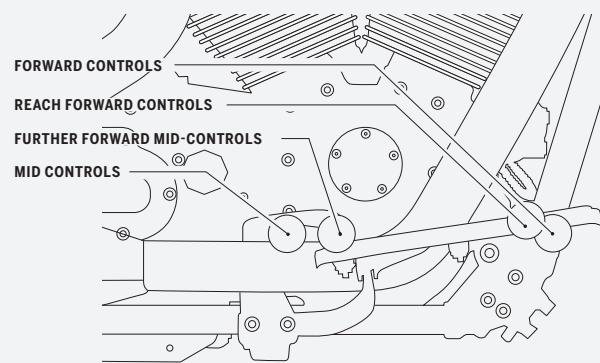

FOOT CONTROLS

Repositioning your feet can relieve muscle tension, take pressure off the tailbone and reduce fatigue. The correct riding position can add hours of comfort and hundreds of miles to your daily saddle time.

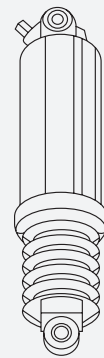

STANDARD HEIGHT

SUSPENSION

Adjusting your motorcycle's ride height by raising or lowering the suspension is often the first step in fitting the bike to your stature. Being sure-footed at a stop can really increase your sense of confidence.



A. SUPER REACH SOLO SEAT

A. SUPER REACH® SOLO SEAT

Get a little bit closer. Super Reach® forward position seats are designed to move riders with a shorter inseam even closer to the controls and to bring the legs about 1.0" closer together so that your feet rest firmly on the pavement. The scooped bucket-shaped saddle is enhanced with added back support padding to move the rider up to 1.0" lower and 3.0" forward. The combination positions the rider closer to the hand and foot controls to offer both comfort and confidence. For a two-up ride, combine the solo seat with the Touring Passenger Pillion P/N 51404-10 (sold separately).

54384-11 **\$266.95**
Fits '06-'17 Dyna® models. Seat width 10.5".

B. TALLBOY® SEAT

Stretch your legs in style. The Tallboy® one-piece seat moves the rider back 1.75" and up 2.0" as compared to the Original Equipment seat. The new position allows additional leg and arm movement for the long-limbed rider and a comfortable seating space for the open road. The Tallboy Seat also features a wide pillion for added passenger comfort.

51471-06 **\$336.95**
Fits '06-'17 Dyna models. FXD, FXDB and FXDLS models require separate purchase of Seat Bumper Kit P/N 51653-06, Passenger Footpegs and Passenger Footpeg Mounting Kit P/N 50210-06. Seat width 16.0"; passenger pillion width 12.0".



B. TALLBOY SEAT



Reach Seats



Tallboy Seats

NOTE: Some Harley-Davidson® seats are made of leather. Fine leathers or other natural materials WILL gain "character;" such as wrinkles or wear, with age. This is normal. A fine, aged patina and character wrinkles are a sign of the extremely high-quality materials used to construct your seat or backrest. The appearance of scars or marks on the leather are a result of using natural leather panels and should not be thought of as an imperfection. Please use Harley-Davidson Leather Protectant P/N 93600034 to protect your investment.

Notice: The prices appearing in this catalog are the manufacturer's suggested retail prices. Actual retail prices may vary.

88 CRUISER

Seating – Dyna®

A. SUNDOWNER™ SEAT

The Sundowner™ Seat provides the maximum in long-riding comfort. The deep-bucket design puts your body in the proper touring position and the generous padding makes it comfortable for both the rider and passenger as the miles are adding up. The dished shape provides added rider back support and the wide passenger pillion is shaped to minimize pressure points.

51540-06 **\$372.95**

Fits '06-'17 Dyna® models. FXD, FXDB and FXDLS models require separate purchase of Seat Bumper Kit P/N 51653-06, Passenger Footpegs and Passenger Footpeg Mounting Kit P/N 50210-06. Seat width 16.0"; passenger pillion width 12.0".



**A. SUNDOWNER SEAT
(SHOWN WITH SMOOTH BUCKET PASSENGER BACKREST PAD)**



**B. SIGNATURE SERIES SEAT WITH RIDER BACKREST
(SHOWN WITH SMOOTH LOW PASSENGER BACKREST PAD)**



C. BADLANDER SEAT



D. LOW-PROFILE LEATHER SEAT

NOTE: Some Harley-Davidson® seats are made of leather. Fine leathers or other natural materials WILL gain "character," such as wrinkles or wear, with age. This is normal. A fine, aged patina and character wrinkles are a sign of the extremely high-quality materials used to construct your seat or backrest. The appearance of scars or marks on the leather are a result of using natural leather panels and should not be thought of as an imperfection. Please use Harley-Davidson® Leather Protectant P/N 93600034 to protect your investment.

Notice: The prices appearing in this catalog are the manufacturer's suggested retail prices. Actual retail prices may vary.

CRUISER 89

Seating – Dyna®

E. PASSENGER PILLION – SMOOTH STYLING

Bring a passenger along for the ride. This Passenger Pillion includes a passenger grab strap.

51404-10 Smooth. **\$170.95**

Fits '09-'17 FXDB and '10-'17 FXDWG models with Original Equipment solo seat. Installation on FXDB models requires separate purchase of Passenger Footpegs and Passenger Footpeg Mounting Kit P/N 50210-06.



E. PASSENGER PILLION – SMOOTH STYLING

F. BOBBER SOLO SADDLE

How low can you go? This minimalist solo seat takes the stripped-down garage-built look about as far as you can go. The thick distressed black leather cover is bonded directly to the formed metal seat pan and minimizes the foam filler and the extra height it brings. The raw-edge leather pad is joined to the pan with brass rivets, and features matching brass "Milwaukee Since 1903" trim that will develop a rich patina with use. The Bar & Shield logo is embossed into the leather surface as a finishing touch. Easy to install, the bolt-on seat and a model-specific installation kit include everything you need to get the bobber look. No cutting, welding or fabrication is necessary.

52000277 Distressed Black Leather. **\$319.95**

Fits '04-'06 and '10-'22 XL, '06-'17 Dyna® and '08-'17 FLS, FLSS, FLSTC, FLSTN and FXS models. Installation requires separate purchase of model-specific Rigid or Spring Seat Mounting Hardware Kit. Seat width 10.5".



F. BOBBER SOLO SADDLE (SHOWN WITH SPRING SADDLE INSTALLATION KIT)

G. ROAD ZEPPELIN® SEAT PAD

Experience ultimate comfort. Designed to ensure hours of comfort in the saddle, Road Zeppelin® Seat Pads are equipped with a unique air bladder system that allows your weight to be supported evenly across the entire seating surface. Shaped to conform to most Harley-Davidson® seats, the pads feature adjustable mounting straps and a non-skid surface to keep them in place. The hand-washable seat pad can be deflated and rolled for compact storage.

52000327 Rider. **\$180.95**

Fits rider position on all models equipped with Original Equipment or accessory seats. Also fits passenger position on Touring models with large pillion area. Pad width – 14.0".

52400162 Passenger. **\$168.95**

Fits Original Equipment and accessory passenger pillions. Pad length – 12.0"; width – 9.0".

H. CIRCULATOR SEAT PADS

Designed to keep the rider cool by reducing the perspiration buildup between you and the seating surface, the Circulator Pad can be installed and removed in seconds for easy cleaning. The low-profile design minimizes seat-height change compared to inflatable pads, while enhancing comfort with its shock-absorbing construction. Elastic under-seat strap and non-slip base provide secure installation and the available Circulator Passenger Pillion Pad attaches to the rider pad with hook-and-loop tabs.

51074-10 Medium Seat Pad. **\$90.95**

Fits VRSC™, XG, XL and Dyna® models with Original Equipment and accessory seats. Pad width – 14.5"

51078-10 Passenger Pillion Pad. **\$74.95**

Fits Original Equipment and accessory passenger pillions. Pad width – 13.0"

52300103 Wide Backrest Pad. **\$64.95**

Fits wide profile rider and passenger backrest pads up to 12.0" wide and 9.0" tall.



G. ROAD ZEPPELIN SEAT PAD



H. CIRCULATOR SEAT PADS

Notice: The prices appearing in this catalog are the manufacturer's suggested retail prices. Actual retail prices may vary.

A. RAIN COVERS*

Featuring a handy storage sack, this black nylon, water-resistant, Cordura® cover packs easily and shelters your seat from the storm.

51638-97 Solo Seat. **\$33.95**
Fits H-D® solo seats (except XR and FLSTS).

51639-97 Two-Up. **\$35.95**
Fits VRSC, XG, XL, Dyna and Softail® models with Two-Up seats. Does not fit Touring and Trike models. Does not fit with Rider Backrests.

B. QUICK-RELEASE SEAT HARDWARE KITS

This Quick-Release Hardware Kit allows the rider to remove one-piece Harley-Davidson® seats quickly and easily.

Fits '97-later XG, XL, Dyna, Softail (except '12-'17 FLS models equipped with Original Equipment seat), Touring and Trike models equipped with SAE 1/4"-20 seat mount hardware. Does not fit seats equipped with spring-loaded rear seat bracket.

51676-97A Chrome. **\$23.95**

10500093 Gloss Black. **\$23.95**

C. TANK KNEE PAD KIT

The rich black rubber pads feature tapered ribs and a raised Bar & Shield logo to protect the surfaces where your legs contact the tank.

57300065 **\$43.95**
Fits fuel tanks on many Harley-Davidson Street®, Sportster®, Dyna and Softail models. May cover a portion of fuel tank graphics; check appearance before adhering to tank.



A. RAIN COVER – SOLO SEAT



A. RAIN COVER – TWO-UP



B. QUICK-RELEASE SEAT HARDWARE KIT – CHROME



B. QUICK-RELEASE SEAT HARDWARE KIT – GLOSS BLACK



C. TANK KNEE PAD KIT

! *WARNING: Do not use while riding; could result in death or serious injury.

Notice: The prices appearing in this catalog are the manufacturer's suggested retail prices. Actual retail prices may vary.

BUILDING A BACKREST

A sissy bar upright and passenger backrest are the starting point to build a complete touring machine. The backrest provides long-range comfort and support and adds a feeling of control and confidence for the passenger. Start by selecting model-specific Docking Hardware, then choose a finish that matches your styling direction, determine the desired sissy bar height and finally select a backrest pad that complements your seat.

DOCKING HARDWARE



SHORT & TALL UPRIGHT



SIDE PLATES



PASSENGER BACKREST PAD



SELECT THE DOCKING HARDWARE

Dyna® Docking Hardware for H-D® Detachables™ Racks and Sideplates
Docking hardware fitment is dependent on vehicle model and saddlebag configuration.

H-D Detachables Accessory	Available to fit:	Required Docking Hardware		Directional Relocation Kit	
No Saddlebags: Detachable Sideplates 52124-09A (Gloss Black), 53543-95B (Chrome), 53834-00A (Wrinkle Black), 52866-06A (Chrome), 53870-01B (Chrome), Detachable Solo Rack 53511-06A, One-Piece Detachable Uprights 51161-10A (Gloss Black), 52300042 (Chrome), One-Piece Detachable Uprights 52300044A (Chrome), 52300046A (Gloss Black)	2006-2008 FXDWG & 2008-2009 FXDF and '09-'10 FXDFSE	53964-06B	\$54.95	—	—
	2006-later FXD, FXDC, FXDL and FXDSE, 2006-2008 FXDB	53961-06	\$54.95	53968-06C	\$54.95
	2009-later FXDB (except 2013-later HDI and India configuration)	53797-09	\$122.95	53968-06C	\$54.95
	2010-later FXDWG	54097-10	\$54.95	53968-06C	\$54.95
With P&A Saddlebags: Adjustable Sideplates 52300110 (Chrome), 52300090 (Gloss Black), Detachable Sideplates 52124-09A (Gloss Black), 53543-95B (Chrome), 53834-00A (Wrinkle Black), 52866-06A (Chrome), Detachable Solo Rack 53511-06A, One-Piece Detachable Uprights 51161-10A (Gloss Black), 52300042 (Chrome), One-Piece Detachable Uprights 52300044 (Chrome), 52300046A (Gloss Black)	2006-2008 FXDWG & 2008-2009 FXDF and FXDFSE/2	53964-06B	\$54.95	—	—
	2006-later FXD, FXDC, FXDL and FXDSE, 2006-2008 FXDB	53961-06	\$54.95	—	—
	2009-later FXDB	53797-09	\$122.95	68227-09	\$118.95
	2010-later FXDWG	54097-10	\$54.95	53968-06C	\$54.95
With P&A Saddlebags: 79300-06D, 88200-09A, 88348-10, 90181-08A, 90307-98, 90369-02, 90369-06D, 90564-02, 90564-06D, 91617-03, 91615-09A, 90126-YYXXX	2010-later FXDF	53964-06B	\$54.95	—	—

Notice: The prices appearing in this catalog are the manufacturer's suggested retail prices. Actual pricing may vary.

DYNA

92 CRUISER

Backrests & Racks

A. H-D® DETACHABLES™ SIDEPLATES

In the time it takes for a traffic light to change, you can transform your motorcycle from a city cruiser to a cross-country hauler. Start with Harley-Davidson® Detachables™ Sideplates, and add your choice of sissy bar upright and pad to make removing the passenger backrest a simple slide and click operation. Manufactured and tested to rigorous Harley-Davidson standards, installation requires separate purchase of model-specific Docking Hardware Kit.

1. Fits '06-'17 Dyna® models (except FLD). Requires separate purchase of appropriate Docking Hardware kit. '13-'17 FXDB models equipped with a side-mount license plate require License Plate Relocation Kit P/N 67900130. '13-'17 FXDB HDI/India configuration require separate purchase of Docking Hardware and Turn Signal Relocation Kit P/N 67800499. Not for use with LED Rear Turn Signal Kit P/N 67800055A or 67800056A.

52866-06A	Chrome.	\$160.95
52124-09A	Gloss Black.	\$160.95

2. Fits '12-'16 FLD models. Requires separate purchase of Docking Hardware Kit P/N 52300065.

52300070A	Chrome.	\$160.95
------------------	---------	-----------------

SISSY BAR UPRIGHTS

Sissy Bar Uprights are available in a variety of shapes and styles. Round bar uprights feature a mini medallion bar and an embossed Bar & Shield insert. Uprights are designed to accept specific 3-bolt or 2-bolt mounted backrest pads.

B. LOW SISSY BAR UPRIGHT

Shaped to complement a thicker passenger pillion, this Low Sissy Bar Upright stands between the Standard and the Short Bar Upright. The ideal match for touring style seats, this upright also offers additional height options to riders with custom-style seats.

Fits '04-'22 XL models with H-D® Detachables™ sideplates, '06-'17 Dyna (except FXDF, FXDFSE and '10-'17 FXDWG), '84-'05 Softail® (except FXSTD) and '06-later FL Softail models (except '07-'17 FLS, FLSS, FLSTF, FLSTFB, FLSTFBS, FLSTSE and FLSTSB and '06 FLSTFSE) with appropriate sideplates.

52300022	Chrome.	\$119.95
52300024	Gloss Black.	\$116.95

C. STANDARD SISSY BAR UPRIGHT

Give your passenger additional back support with a Standard Sissy Bar Upright designed to accept a wide variety of backrest pads.

Fits '04-'22 XL models with H-D Detachables sideplates, '06-'17 Dyna (except FXDF, FXDFSE and '10-'17 FXDWG), '84-'05 Softail (except FXSTD) and '06-later FL Softail models (except '07-'17 FLS, FLSS, FLSTF, FLSTFB, FLSTFBS, FLSTSE and FLSTSB and '06 FLSTFSE) with appropriate sideplates.

52300018	Chrome.	\$116.95
52300020	Gloss Black.	\$116.95



A. H-D DETACHABLES SIDEPLATES



B. LOW SISSY BAR UPRIGHT – CHROME
(52300022 SHOWN)



B. LOW SISSY BAR UPRIGHT – GLOSS BLACK
(52300024 SHOWN)



C. STANDARD SISSY BAR UPRIGHT – CHROME
(52300018 SHOWN)



C. STANDARD SISSY BAR UPRIGHT – GLOSS BLACK
(52300020 SHOWN)

CRUISER 93

Backrests

D. ONE-PIECE H-D® DETACHABLES™ SISSY BAR UPRIGHT

The sweeping shape of this slim, round bar Sissy Bar Upright completes the classic bobber look. The one-piece design eliminates separate sideplates for a clean appearance and the stylized upper kick angle mimics the old-school sissy bars of the '50s and '60s. Available in chrome and gloss black finishes, these bars can be equipped with Passenger Backrest Pad P/N 52631-07.

Fits '06-'17 Dyna® models (except FLD, FXDF, FXDFSE and '10-'17 FXDWG). Requires separate purchase of appropriate Docking Hardware Kit. '13-'17 FXDB models equipped with a side-mount license plate require License Plate Relocation Kit P/N 67900130. '13-'17 FXDB HDI/India configuration require separate purchase of Docking Hardware and Turn Signal Relocation Kit P/N 67800499. Not for use with LED Rear Turn Signal Kit P/N 67800055A or 67800056A.

52300046A	Gloss Black.	\$225.95
------------------	--------------	-----------------

Fits '10-'17 FXDF and FXDWG models. Installation requires separate purchase of appropriate Docking Hardware Kit. Dyna Wide Glide® models require separate purchase of Docking Hardware Kit P/N 54097-10 and Turn Signal Relocation Kit P/N 53968-06C.

51161-10A	Gloss Black.	\$225.95
------------------	--------------	-----------------

Shown with:

PASSENGER BACKREST PAD

Styled to complement available touring and custom seats.

52631-07	\$79.95
-----------------	----------------

Fits One-Piece H-D® Detachables™ Sissy Bar Upright P/N 52729-08, 51853-07, 51849-07, 51146-10A, 51161-10A, 52300040A, 52300042A, 52300044A or 52300046A.

E. LOCKING H-D® DETACHABLES™ LATCH KIT

This unique lock replaces the camlock on your Harley-Davidson® Detachables™ accessories, providing additional security and peace of mind when parking your vehicle. The kit includes two extended-reach barrel-style keys for easy access to the lock. Key registration and replacement service is available. Sold in pairs.

Fits all models equipped with detachable Sideplates, Racks and Tour-Pak® Luggage Carriers (except '18-later Softail® models with HoldFast™ racks and uprights or '09-later Touring models equipped with detachable Solo Tour-Pak Rack).

92800008	Black.	\$78.95
-----------------	--------	----------------

F. H-D DETACHABLES LATCH KIT – CHROME

Decorative chrome latches are the perfect way to enhance the appearance of your detachable accessories. Meticulously polished and chrome-plated, these easy-to-install Rotary Latches are a direct replacement for the Original Equipment satin black parts and are a simple way to add a finishing touch to your ride. Latches feature an easy-to-pull finger release to simplify access in hard-to-reach areas.

12600036	\$54.95
-----------------	----------------

Fits all models equipped with detachable Sideplates, One-Piece Sissy Bar Uprights, Racks, and Tour-Pak Luggage Mounting Racks. (except '18-later Softail models with HoldFast racks and uprights).

G. REAR DOCKING HARDWARE COVER KIT

Disguise the rear docking hardware with these easy-to-install covers. The caps slide over the exposed docking points and are held in place by a strong magnetic pull. The caps are easy to remove when you wish to reinstall detachable accessories. Covers are available with brilliant chrome or durable gloss black finish to match your bike's attitude. Sold in pairs.

Fits many accessory docking hardware kits. Refer to the fitment matrix in this P&A Catalog or the Parts & Accessories section of www.harley-davidson.com for details.

48218-10	Short Chrome (pair).	\$38.95
48220-10	Large Chrome (pair).	\$38.95
48035-09	Small Chrome (pair).	\$38.95
48221-10	Short Black (pair).	\$38.95
48223-10	Large Black (pair).	\$38.95
48225-10	Small Black (pair).	\$38.95



D. ONE-PIECE H-D DETACHABLES SISSY BAR UPRIGHT



E. LOCKING H-D DETACHABLES LATCH KIT – BLACK



F. H-D DETACHABLES LATCH KIT – CHROME



G. REAR DOCKING HARDWARE COVER KIT – CHROME



G. REAR DOCKING HARDWARE COVER KIT – GLOSS BLACK

Notice: The prices appearing in this catalog are the manufacturer's suggested retail prices. Actual retail prices may vary.

Notice: The prices appearing in this catalog are the manufacturer's suggested retail prices. Actual retail prices may vary.

94 CRUISER

Backrests & Racks

PASSENGER BACKREST PADS

Choose from a wide variety of backrest pad sizes and shapes to match your comfort and style demands. Designed to complement Original Equipment and accessory seats, these pads are engineered to fit specific sissy bar upright types.

A. SLIP-OVER PASSENGER BACKREST PAD

This Slip-Over Backrest Pad provides a touch of passenger comfort, while maintaining the long, lean style of the Dyna® Wide Glide® model. Held in place with hook-and-loop tabs, this rich black pad features grey stitching that complements the Original Equipment seat and pillion.

51732-10 Chrome. **\$74.95**
Fits '07-'22 XL models with Low-Profile Sissy Bar Upright P/N 52300403 and '10-'17 FXDWG models with Original Equipment sissy bar upright.

B. BACKREST PADS

Sized to fit medallion and mini medallion-style sissy bar uprights. Pad mounts with single center screw and bolt-on mounting strap. Includes chrome-plated mounting hardware.

Fits Low Medallion Style Sissy Bar Upright P/N 52754-04 or 51851-09, Low Square Bar Mini-Medallion Style Sissy Bar Upright P/N 53282-06, Standard Square Bar Mini Medallion Style Sissy Bar Upright P/N 53281-06 or 53407-06, Standard Medallion Style Sissy Bar Upright P/N 52735-85, 53007-98, 52655-84, 52909-02 or 51517-02, Standard Bar & Shield Style Sissy Bar Upright 52739-83 or 51514-02, Standard Heritage Style Sissy Bar Upright P/N 52731-00 and Low Round Bar Sissy Bar Upright P/N 52300022 or 52300024.

1. 52652-04 Smooth. **\$79.95**
2. 52626-04 Smooth Top-Stitched. **\$79.95**

C. BACKREST PADS

Sized to fit medallion and mini medallion-style sissy bar uprights. Pad mounts with single center screw and bolt-on mounting strap. Kit includes chrome-plated mounting hardware.

Fits Low Medallion Style Sissy Bar Upright P/N 52655-84, 52909-02, 52754-04, 51851-09, Standard Medallion Style Sissy Bar Upright P/N 52735-85 or 52877-08, Standard Square Bar Mini Medallion Style Sissy Bar Upright P/N 53281-06 or 53407-06, Standard Heritage Style Sissy Bar Upright P/N 52731-00 and Standard Round Bar Sissy Bar Upright P/N 52300018 or 52300020.

1. 52612-95 Smooth Top-Stitched. **\$79.95**
2. 52412-79A Embossed Bar & Shield Logo. **\$84.95**
3. 52348-97 Heritage Classic Bucket. **\$118.95**
4. 52347-97 Fat Boy® Bucket. **\$118.95**
5. 51132-98 Smooth Bucket. **\$107.95**

D. BACKREST PADS

Sized to fit round bar sissy bar uprights, these pads mount to mini medallion style uprights with two mounting holes.

Fits Nightster® standard and short uprights P/N's 52300702 and 52300700. Fits Standard Round Bar Mini-Medallion Style Upright P/N 52877-10 or 51168-10. Fits Low Round Bar Mini Medallion Style Sissy Bar Upright P/N 52300401, 52540-09A, 51477-06, 54256-10, 52300049 and 52300050.

1. 51641-06 Smooth Top-Stitched. **\$79.95**
2. 51622-07 Fat Boy Lacing Bucket. **\$129.95**



A. SLIP-OVER PASSENGER BACKREST PAD



B. BACKREST PADS



C. BACKREST PADS



D. BACKREST PADS



E. AIR FOIL PREMIUM LUGGAGE RACK – CHROME



F. AIR FOIL PREMIUM LUGGAGE RACK – GLOSS BLACK

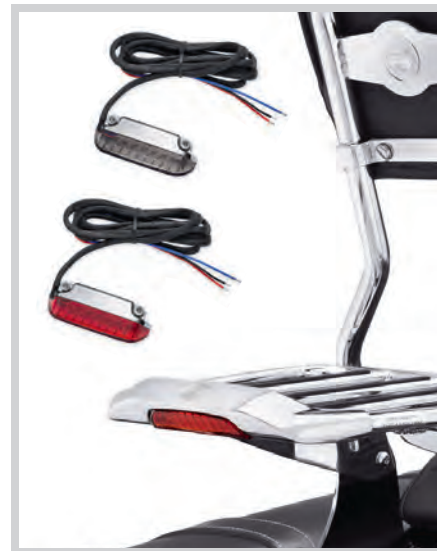

G. FIVE BAR SPORT LUGGAGE RACK – CHROME

CRUISER 95

Backrests & Racks

E. AIR FOIL PREMIUM LUGGAGE RACK*

The low-profile aerodynamic styling defines the look of this Luggage Rack. Available in mirror chrome or rich gloss black finish, the die-cast rear "Air Foil" grabs your attention and the Bar & Shield insert adds a signature touch. The elegant round tube rack features inlaid rubber runners for added grip and dedicated bungee mounting points to simplify luggage tie-down. Kit includes all necessary mounting hardware. For added visibility, the rack is designed to incorporate the internal wiring of the Air Foil Rack LED Light Kit P/N 68000076 (red) or 68000077 (smoked) for a clean look.

Fits '04-'22 XL models equipped with H-D® Detachables™ Sideplates, '06-'17 Dyna® models (except FXDF, FXDFSE and '10-'17 FXDWG) equipped with Detachable Sideplates, '84-'05 Softail® (except FLSTN and FXSTD) and '06-'17 FLST, FLSTC, FLSTNSE and FLSTSC and '06 FLSTF models equipped with Detachable Sideplates.

54290-11 Chrome. **\$230.95**
54291-11 Gloss Black. **\$230.95**

F. LED LIGHT KIT**

This fast-acting LED Light Kit operates as a supplemental rear running light and brake light. The high, center-mount position places the light in the line-of-sight of following vehicles and the bright, fast-acting LED lamps get you noticed. Wiring is concealed inside the rack tubes for a clean, custom installation. Available with red lens.

Fits Air Foil Luggage Rack P/N 54290-11, 54291-11 and Air Wing Sissy Bar Upright P/N 52300146 and 52300147. Installation requires separate purchase of model-specific Wiring Harness Kit.

68000076 Red Lens. **\$54.95**

Also available:

LED LIGHT KIT WIRING HARNESS

Required for installation of LED Light Kit on Air Foil Luggage Rack P/N 54290-11 or 54291-11.

73415-11 **\$14.95**

Fits '06-'17 Dyna (except FXDF, FXDFSE, '14-'17 FXDL, '16-'17 FXDLS and '10-'17 FXDWG), '84-'05 Softail (except FXSTD and FLSTN), '06-'17 FLST, FLSTC and FLSTSC and '06 FLSTF models with Air Foil Luggage LED Light Kit P/N 68000076 or 68000077.

G. FIVE BAR SPORT LUGGAGE RACK – CHROME*

This rack brings touring flexibility to your motorcycle. Can be used with H-D Detachables or Rigid Mount Sissy Bar Sideplates.

53862-00 **\$168.95**

Fits '04-'22 XL models (except XL1200CX) equipped with Detachable Sideplates, '06-'17 Dyna models (except FXDF, FXDFSE and '10-'17 FXDWG) equipped with Detachable Sideplates, '84-'05 Softail (except FLSTN and FXSTD), '06-'17 FLST, FLSTC and FLSTSC and '06 FLSTF models equipped with Detachable Sideplates. Does not fit with Round Bar Uprights P/N 52300018, 52300020, 52300022 and 52300024.

! WARNING: Do not use this rack as a seat. Do not exceed the fender rack weight capacity. Using as seat or exceeding this capacity could cause handling problems, which could result in loss of control and death or serious injury.

! **WARNING: Disconnecting your DOT-required tail, brake and turn signal lighting could reduce your visibility to others and result in death or serious injury.

Notice: The prices appearing in this catalog are the manufacturer's suggested retail prices. Actual retail prices may vary.

Notice: The prices appearing in this catalog are the manufacturer's suggested retail prices. Actual retail prices may vary.

96 CRUISER

Saddlebags

A. RIGID LOCKING LEATHER SADDLEBAGS

These saddlebags combine a premium leather finish with extra-durable construction. The hard-shell design is covered in leather for a traditional look, while the locking hinged lids offer modern convenience and security. Styled to complement the sleek, narrow Dyna® motorcycle profile, these bags offer plenty of storage for a trip across town or across the country. Kit includes reflectors. Luggage capacity: 2400 cubic inches total.

91615-09A **\$846.95**

Fits '02-'17 Dyna models (except FLD, '02-'05 FXDWG and '09-'17 FXDB with optional strut covers). '02-'05 models require separate purchase of Mounting Hardware Kit P/N 92025-09. '10-'17 FXDWG models require separate purchase of Turn Signal Relocation Kit P/N 68544-10. '09-'17 FXDB models require separate purchase of Turn Signal Relocation Kit P/N 68227-09. '13-'17 FXDB models equipped with side-mount license plate requires License Plate Relocation Kit P/N 67900130. '16-'17 FXDLS models require separate purchase of Turn Signal Relocation Kit P/N 68227-09 and Side Mount License Plate Kit P/N 60938-10 or 60978-10. All other years and models (except FXDF and FXDWG) require separate purchase of Turn Signal Relocation Kit P/N 68732-02A (Domestic), 68733-02A (International) or Layback License Plate Kit P/N 60215-06. Not for use with Rear Axle Covers on FXDF and FXDWG models.

B. SYNTHETIC LEATHER SADDLEBAGS

These synthetic leather saddlebags deliver both style and large capacity at a low cost. The rigid plastic tub is wrapped in synthetic leather for long-term durability. The bag features a large protective lid with hook-and-loop and snap closure and an inner pocket for small item storage. Luggage capacity: 2380 cubic inches total.

90564-06D **\$547.95**

Fits '02-'17 Dyna models (except FLD, '02-'05 FXDWG and '09-'17 FXDB with optional strut covers). '02-'05 models require separate purchase of Mounting Hardware Kit P/N 92025-09. '09-'17 FXDB models require separate purchase of Turn Signal Relocation Kit P/N 68227-09. '10-'17 FXDWG models require separate purchase of Turn Signal Relocation Kit P/N 68544-10. '13-'17 FXDB models equipped with side-mount license plate requires License Plate Relocation Kit P/N 67900130. '16-'17 FXDLS models require separate purchase of Turn Signal Relocation Kit P/N 68227-09 and Side Mount License Plate Kit P/N 60938-10 or 60978-10. All other years and models (except FXDF and FXDWG) require separate purchase of Turn Signal Relocation Kit P/N 68732-02A (Domestic), 68733-02A (International) or Layback License Plate Kit P/N 60215-06. Not for use with Rear Axle Covers on FXDF and FXDWG models.

Also available:

TURN SIGNAL RELOCATION KIT

Required for installation of saddlebags and detachable accessories on '09-later FXDB models.

68227-09 **\$118.95**

Fits '09-'17 FXDB models (except models with optional fender strut covers).

TURN SIGNAL RELOCATION KIT

Kit moves turn signals from rear fender struts to a license bracket-mounted turn signal bar.

Required to install Saddlebags P/N 91615-09A, 88200-09A, 90181-08A, 90460-06B, 79300-06D, 90564-06D, 90369-06D, and 88343-10. Fits '02-'17 Dyna (except FXDF, FXDWG and '09-'17 FXDB) and '04-'22 XL models (except XL883N, XL1200N, XL1200NS, XL1200X, XL1200XS and '11-22 XL1200C). Does not fit with Layback License Plate Mounting Kits.

68732-02A Domestic. **\$95.95**

68733-02A International. **\$95.95**

LICENSE PLATE/TURN SIGNAL RELOCATION KIT

Required for installation of Saddlebags.

68544-10 **\$266.95**

Fits '10-'17 FXDWG models equipped with saddlebags.

LICENSE PLATE RELOCATION KIT

Required for installation of available saddlebags and/or detachable sissy bars on '13-later FXDB models equipped with side-mount license plate. Kit replaces Original Equipment side-mount license plate.

67900130 **\$144.95**

Fits '13-'17 FXDB models equipped with side-mount license plate.

Notice: The prices appearing in this catalog are the manufacturer's suggested retail prices. Actual retail prices may vary.



A. RIGID LOCKING LEATHER SADDLEBAGS



B. SYNTHETIC LEATHER SADDLEBAGS



C. PREMIUM RIDE SINGLE CARTRIDGE FORK KIT



D. PREMIUM RIDE EMULSION SHOCKS

CRUISER 97

Suspension

C. PREMIUM RIDE SINGLE CARTRIDGE FORK KIT*

This Single-Sided Cartridge Fork provides improved handling performance by keeping the tire in contact with the road surface. Tuned to work in concert with the Premium Emulsion Rear Shocks, the fork damping is controlled by a specifically calibrated piston and valve stack. Unlike typical orifice damping, the piston/valve system helps the cartridge fork achieve a linear damping force curve for consistent feel throughout the compression and extension of the front suspension. The cartridge allows the forks to react quickly to rough roads, inspiring rider confidence in sweeping corners. The compression piston provides excellent low-speed damping for a better rider feel, and the rebound spring provides a smoother feel during topping. The cartridge fork resists bottoming and dive, and the triple rate spring and oil lock allow the forks to absorb bumps even under hard braking – giving the rider more control while resisting wheel hop. A perfect addition during the installation of chrome or gloss black lower fork sliders, the kit includes fork pipe, cartridge, fork bolts, main springs and oil seals.

45400058 **\$372.95**

Fits '06-'17 Dyna® models (except FLD, FXDWG and '07-'08 FXDSE). Original Equipment on FXDLS models.

D. PREMIUM RIDE EMULSION SHOCKS*

Experience a comfortable and confidence-inspiring ride – no matter the pavement conditions – with Harley-Davidson® Premium Ride Emulsion Shocks. These fast-acting mono-tube nitrogen gas-charged shocks offer enhanced compression and rebound damping control when compared to typical twin-tube shock absorbers. The nitrogen gas charged shocks resist oil aeration and work with the internal valve stack to provide superior damping control in the twisties. The large 36mm pistons and low viscosity high-performance oil allow these shocks to react quickly to impacts and keep the tires tracking the road surface. You get a controlled ride and minimized bottoming harshness transmitted through the frame. The locking threaded adjustment lets you fine-tune the spring preload to your current riding conditions – whether a solo run on the back roads or a fully loaded two-up freeway tour – and urethane bumpers provide a softer feel if the shock bottoms under load. The beautifully finished shocks feature black-anodized billet top caps and black progressively-wound springs. Kit includes left and right shock and preload adjustment spanner wrench.

54000066 Stock Height. **\$638.95**

Fits '06-'17 Dyna models (except FLD and '07-'08 FXDSE). Original Equipment on FXDLS models.



***WARNING:** Installation of any accessory suspension components may affect cornering clearance and jiffy stand operation. This could distract the rider, causing loss of control and death or serious injury.

Notice: The prices appearing in this catalog are the manufacturer's suggested retail prices. Actual retail prices may vary.

DYNA

98 CRUISER

Foot Controls

A. STANDARD FORWARD CONTROLS*

Stretch out for maximum comfort and style. This complete kit includes all components necessary to convert a mid control-equipped Dyna® model to forward controls. Moves controls 11.0" forward from mid control foot position. Kit is available in chrome or gloss black to match your customizing style.

Fits '06-'17 Dyna models with mid controls. FLD models require separate purchase of footpegs.

49080-06A	Chrome.	\$452.95
49021-09	Gloss Black.	\$452.95



A. STANDARD FORWARD CONTROLS – CHROME



B. REACH FORWARD CONTROL CONVERSION KIT

B. REACH FORWARD CONTROL CONVERSION KIT*

This Forward Control Conversion Kit repositions the Original Equipment footpegs and foot controls up and back by over 1.0", positioning the controls closer to the rider for added comfort and confidence. The reduced reach places the rider's boot at the proper pivot point for improved leverage, while maintaining the "foot-forward" riding profile. This easy-to-install Conversion Kit includes heavy-duty steel mounts and shortened brake rod. Kit reuses Original Equipment control supports and brake and shift levers or can be personalized with your choice of custom lever styles.

50700005		\$221.95
Fits '03-'17 Dyna models (except FLD) equipped with forward controls.		

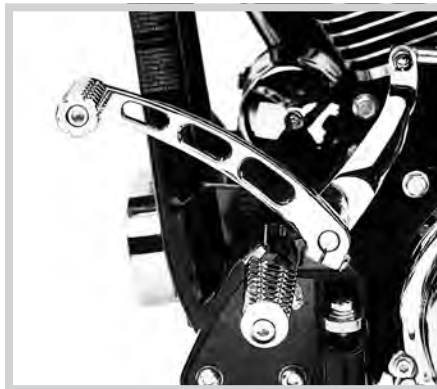

C. BILLET STYLE SHIFT LEVER – CHROME



C. BILLET STYLE SHIFT LEVER – EDGE CUT

C. BILLET STYLE SHIFT LEVER

Styled to complement our billet style mirror stems, these Billet Style Shift Levers are forged from 6061-T6 aluminum, then machined and finished in chrome, satin black or edge cut styles for a beautiful, custom look. Includes chrome hardware.

Fits '91-'17 Dyna® (except '14-'17 FXDL, FXDLS or models equipped with Further Forward Mid-Control Kit P/N 50500386) and '90-'17 FX Softail® models.

34539-00	Chrome.	\$99.95
34043-10	Edge Cut.	\$104.95
34016-08	Satin Black.	\$99.95

D. RIDER FOOTBOARD KIT

Convert your Dyna® model to touring-oriented footboard-based controls. Ideal for riders with an inseam too long for mid controls or for riders who prefer the extra foot room on long rides, this complete kit moves the foot brake and shift lever forward from the standard position. The installation places the rider into a comfortable upright posture with a flat foot and bent knee profile. The kit includes left and right footboards with inserts, footboard supports, brake lever, brake and shift linkage, brake pedal pad and all required hardware. Installation reuses Original Equipment shift lever. Customize the look by adding your choice of accessory traditional D-shaped rider footboard inserts and large brake pedal pads.

50500247		\$473.95
Fits '06-'17 FXD, FXDB and FXDC, '06-'13 FXDL and '06-'08 FXDWG models. Stock on '12-'16 FLD models. Fits '17 FXDBP and FXDBC. Does not fit with frame-mounted highway pegs.		



C. BILLET STYLE SHIFT LEVER – SATIN BLACK



D. RIDER FOOTBOARD KIT

E. RIDER FOOTBOARD HEEL GUARD

Avoid damaged boots and hours of cleaning melted rubber scuff marks from your exhaust shield. This Heel Guard mounts to the right-side rider footboard and The subtle curved shape keeps the boot heel away without restricting fore-and-aft movement of the rider's foot. Kit includes chrome guard with cutaway Bar & Shield logo and all mounting hardware.

50500225		\$74.95
Fits '12-'16 FLD, '86-'17 FL Softail, '86-later Touring and '09-later Trike models equipped with Traditional and Swept Wing footboards. Does not fit models equipped with Half-Moon, Tapered, Airflow, Defiance, Dominion™ or Burst footboards, Extended Reach Rider Footboards P/N 50409-04 or 54145-10, Rider Running Boards P/N 50500158 or Screamin' Eagle® Fat Exhaust Shields.		



E. RIDER FOOTBOARD HEEL GUARD



E. RIDER FOOTBOARD HEEL GUARD



F. PASSENGER FOOTBOARD PAN KIT – CHROME, CLASSIC STYLE



F. PASSENGER FOOTBOARD PAN KIT – CHROME, CONTEMPORARY STYLE

CRUISER 99

Foot Controls

F. PASSENGER FOOTBOARD PAN KIT – CHROME

Replace the factory black painted passenger footboard with the custom look of smooth chrome. These chrome-plated Footboard Pans are ready to install using your Original Equipment hardware and the kit includes left- and right-side Footboard Pans. Just add your choice of Footboard Insert for the finishing touch. Footboard Supports sold separately.

Fits '06-'17 Dyna®, '18-later Softail® (except FXDRS, FXFB and FXFBS) and '86-later Touring models equipped with passenger footboard supports. Does not fit Trike models.

50501144	Classic Style.	\$180.95
50501147	Contemporary Style.	\$180.95

G. PASSENGER FOOTBOARD PAN KIT – BLACK

Complete the blacked-out transformation. Replace your chrome Passenger Footboard Pans with sinister black. Kit includes left- and right-side Footboard Pans and is installed using the Original Equipment hardware. Custom Footboard Inserts and Footboard Supports sold separately.

Fits '06-'17 Dyna, '18-later Softail (except FXDRS, FXFB and FXFBS) and '86-later Touring models equipped with passenger footboard supports. Does not fit Trike models.

50501610	Classic Style.	\$180.95
50501611	Contemporary Style.	\$180.95

H. PASSENGER FOOTBOARD PANS – CHROME

Replace the factory black painted passenger footboard with the custom look of smooth chrome. The kit includes left- and right-hand traditional D-shaped footboard pans, chrome-plated and ready to install with your Original Equipment hardware. Footboard inserts and footboard supports sold separately.

50752-04	Traditional Style.	\$180.95
Fits '06-'17 Dyna, '00-later Softail (except FXDRS, FXFB and FXFBS) and '86-later Touring and Trike models equipped with passenger footboard supports.		

I. HALF-MOON PASSENGER FOOTBOARD PANS AND INSERTS

Styled to match the Half-Moon Rider Footboards, these classic passenger footboards add both style and comfort to your nostalgic ride. Available in mirror-finish chrome or gloss black finish, the kit includes left and right footboard pan and vibration-isolation footboard inserts. Model-specific footboard mounts are sold separately.

Fits '06-'17 Dyna, '00-later Softail (except FXDRS, FXFB and FXFBS) and '86-later Touring models equipped with passenger footboard supports. Does not fit Trike models.

50807-08	Chrome.	\$221.95
50810-08	Gloss Black.	\$209.95

J. SWEEP WING PASSENGER FOOTBOARD PANS

These unique Swept Wing Passenger Footboard pans complement the Swept Wing Rider Footboard shape and allow you to replace the Original Equipment passenger footpegs on certain models with footboards. When folded, the footboard displays a mirror chrome surface in your choice of smooth or "ball-milled" grooved design. Footboard inserts and footboard supports sold separately.

Fits '06-'17 Dyna, '00-later Softail (except FXDRS, FXFB and FXFBS) and '86-later Touring models equipped with passenger footboard supports. Does not fit Trike models.

50357-04	Chrome – Grooved.	\$180.95
50716-04	Chrome – Smooth.	\$180.95



G. PASSENGER FOOTBOARD PAN KIT – GLOSS BLACK, CLASSIC STYLE



G. PASSENGER FOOTBOARD PAN KIT – GLOSS BLACK, CONTEMPORARY STYLE



H. PASSENGER FOOTBOARD PANS – CHROME



I. HALF-MOON PASSENGER FOOTBOARD PANS – GLOSS BLACK SHOWN



J. SWEEP WING PASSENGER FOOTBOARD PANS – CHROME GROOVED



J. SWEEP WING PASSENGER FOOTBOARD PANS – CHROME SMOOTH

***WARNING:** Installation of accessory Forward Control Kits may affect cornering clearance. This could distract the rider, causing loss of control, resulting in death or serious injury.

Notice: The prices appearing in this catalog are the manufacturer's suggested retail prices. Actual retail prices may vary.

Notice: The prices appearing in this catalog are the manufacturer's suggested retail prices. Actual retail prices may vary.

100 CRUISER

Foot Controls

A. PASSENGER FOOTPEG SUPPORT KIT – WRINKLE BLACK

Add footpegs to your solo seat-equipped Dyna® motorcycle. Kit includes left and right footpeg supports and mounting hardware. Footpegs and footpeg hardware sold separately.

Fits '06-'17 Dyna models.

50210-06 Wrinkle Black. **\$84.95**

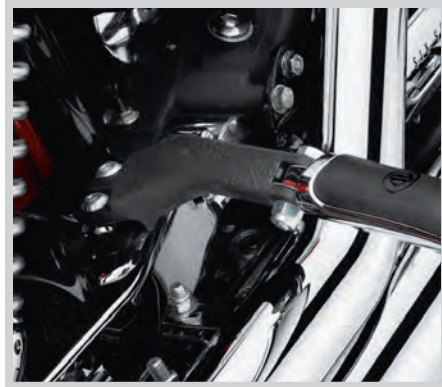

A. PASSENGER FOOTPEG SUPPORT KIT – WRINKLE BLACK



A. PASSENGER FOOTPEG SUPPORT KIT – WRINKLE BLACK

B. ADJUSTABLE PASSENGER FOOTPEG MOUNT KIT

Maximize your passenger's riding comfort. Proper foot position reduces the cramped or stretched-out feeling and relieves pressure on the knees and the tailbone. These Adjustable Mounts raise and lower the passenger footpeg to accommodate taller and shorter passengers. Easy to adjust with common tools, the mount adjusts through a 360° range (depending on model), allowing both fore and aft and up and down height adjustment. Kit includes left and right adjustable support assembly and all required mounting hardware. Footpegs sold separately.

50763-09 **\$160.95**

Fits models with H-D® male-mount style passenger footpeg supports (except Softail® models). Does not fit with Heel Raiser Footpeg Kit P/N 50178-09. Does not fit the rider position.



B. ADJUSTABLE PASSENGER FOOTPEG MOUNT KIT



C. JIFFY STAND EXTENSION KIT

C. JIFFY STAND EXTENSION KIT

Jiffy Stand Extension Kits have been ergonomically designed to simplify the deployment and retraction of the jiffy stand. The extension is shaped to simplify locating the tab with your boot and aid in swinging the jiffy stand into position. The move feels natural and adds confidence when parking your motorcycle in a tight spot. Kit mounts to Original Equipment jiffy stand and includes all required mounting hardware.

50000032 **\$43.95**

Fits '93-'17 Dyna models (except FXDFSE, FXDS-CONV, FXDSE, FXDWG2, FXDWG3, FXDX, FXDXT, '99-'00 FXR and '01-'04 FXDL).

D. MINI FOOTBOARD KIT*

This Footboard Kit can be installed in place of traditional footpegs and provides a little additional leg support and more options to move your legs around on a long ride. Mini Footboards mount to the standard H-D® style footpeg supports and can be used in many rider, passenger and highway applications. Sole-gripping rubber complements Original Equipment or accessory footboards and footpegs and adds vibration isolation and a rich appearance.

Fits rider position:

'02-'17 VRSC™ models with forward controls (except VRSCDX and VRSCF), '15-'20 XG models (except XG750A), '06-earlier XL, '07-'10 XL883, XL883C, XL883R, XL1200C, XL1200R and '07-'11 XL1200L, '91-'17 Dyna® models (except FLD) and '84-'17 Softail models with forward controls (except FXCW, FXCWC, FXS, FXSB or FXSBSE).

Fits passenger position:

All models with H-D male-mount passenger peg mounts (except '06-earlier VRSC, '03-earlier XL, '05-earlier Dyna and Softail models equipped with Shotgun exhaust). '84-'17 Softail models require separate purchase of Support Kit P/N 50454-09. Does not fit passenger position on '18-later Softail models.

Fits highway peg position:

All models with frame-mount or engine guard-mount highway pegs (except Whiskers Adjustable Highway Bar P/N 50855-09 and 50865-09).

50500139 Small 3.0" – Chrome. **\$139.95**

50500144 Small 3.0" – Gloss Black. **\$139.95**

50500109 Large 4.0" – Chrome. **\$139.95**

50500124 Large 4.0" – Gloss Black. **\$139.95**



D. MINI FOOTBOARD KIT – (LARGE CHROME SHOWN)



D. MINI FOOTBOARD KIT – (LARGE BLACK SHOWN)



D. MINI FOOTBOARD KIT



***WARNING:** Do not use highway pegs under normal stop and go operating conditions. Doing so could result in death or serious injury.

Notice: The prices appearing in this catalog are the manufacturer's suggested retail prices. Actual retail prices may vary.

CRUISER 101

Engine Guards

E. ENGINE GUARD KIT*

The one-piece Engine Guard is designed to complement the lines of the motorcycle and the available chrome or gloss black finish adds the perfect finishing touch.

For use with the mid or forward controls. Fits '06-'17 Dyna® models. '14-'17 FXDL, FXDLS (all markets) and '15-'17 Dyna (India models only) require separate purchase of Horn Relocation Bracket P/N 69000058. Fits with Oil Cooler Kit P/N 26151-07B. '07-'08 FXDSE and '09-'10 FXDFSE requires removal of front chin spoiler and separate purchase of Regulator Caddy P/N 70464-08A. '06-'11 models equipped with evap canister also require separate purchase of Canister Bracket P/N 47207-06. '12-'17 models equipped with evap canister require separate purchase of Canister Relocation Kit P/N 60800005.

49010-06 Chrome. **\$242.95**

49320-09 Gloss Black. **\$242.95**

Also available:

EVAPORATIVE CANISTER RELOCATION KIT

60800005 **\$33.95**

Required when mounting Engine Guard P/N 49320-09 or 49010-06 on '12-'17 Dyna models designated for California and Asia-Pacific markets.

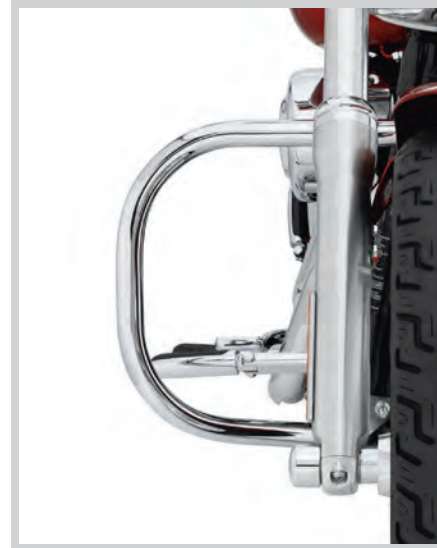

E. ENGINE GUARD KIT – CHROME



E. ENGINE GUARD KIT – GLOSS BLACK



F. MUSTACHE ENGINE GUARD – CHROME



F. MUSTACHE ENGINE GUARD – GLOSS BLACK



G. PREMIUM OIL COOLER KIT – DYNA HORIZONTAL MOUNT



G. PREMIUM OIL COOLER KIT – DYNA SIDE MOUNT

F. MUSTACHE ENGINE GUARD*

The flow of this engine guard complements the bike's traditional style while the gracefully curved upper section incorporates highway pegs into the shape. The integrated rubber pads offer a comfortable and slip-resistant cushion for your feet while traveling the open road. One-piece engine guard kit includes all required mounting hardware.

Fits '06-'17 Dyna models. '14-'17 FXDL, FXDLS (all markets) and '15-later Dyna (India models only) require separate purchase of Horn Relocation Bracket P/N 69000058. Fits with Oil Cooler Kit P/N 26151-07B. '07-'08 FXDSE and '09-'10 FXDFSE requires removal of front chin spoiler and separate purchase of Regulator Caddy P/N 70464-08A. '06-'11 models equipped with evap canister also require separate purchase of Canister Bracket P/N 47207-06. '12-'17 models equipped with evap canister require separate purchase of Canister Relocation Kit P/N 60800005.

49000077 Chrome. **\$314.95**

49000078 Gloss Black. **\$314.95**

Also available: (not shown)

HORN BRACKET ADAPTER

69000058 **\$11.95**

Fits '14-'17 FXDL and FXDLS (all markets) and '15-'17 Dyna (India models only) equipped with Engine Guard P/N 49010-06, 49320-09, 49000077 or 49000078.

G. PREMIUM OIL COOLER KITS

This oil cooler was designed specifically for Harley-Davidson to out-perform all other coolers in the industry. The cooler features a unique Turbulator system that evenly distributes oil across the cooling chambers. The air fins are designed to efficiently dissipate heat. The oil cooler has been designed to simplify installation and enhance performance. The large heat exchanger provides excellent cooling efficiency. The kit features a one-piece adapter plate with integrated thermostat that allows oil lines to connect to the oil filter bracket. Thermostat activates at 185°F (85°C). Kit comes complete with mounting hardware and precut oil lines.

26151-07B Horizontal Mount. **\$465.95**

Fits '06-'17 Dyna models (except FLD, FXDSE, FXDFSE, FXDLS and California models). Does not fit with Front Spoiler Kits or DEFINITIVE5™ Filtration System Kits. Fits with all H-D® Engine Guards. Includes chrome oil cooler cover.

62700017A Side Mount. **\$465.95**

Fits '07-'17 Dyna models (except FXDLS). Fits with all H-D® Engine Guards. Includes gloss black Oil Cooler Cover.



***WARNING:** Do not use highway pegs under normal stop and go operating conditions. Doing so could result in death or serious injury.



***WARNING:** These guards may provide limited leg and cosmetic vehicle protection under unique circumstances (fall over while stopped, very low speed slide). They are not made nor intended to provide protection from bodily injury in a collision with another vehicle or any other object.

Notice: The prices appearing in this catalog are the manufacturer's suggested retail prices. Actual retail prices may vary.

102 CRUISER

Chassis Trim – Front End

A. DASH PANEL EXTENSION – CHROME

Stretch the lines of your chrome dash panel the full length of the fuel tank. This chrome-plated trim kit continues the lines and finishes of your standard tank panel to the front of the seat. The curving lines and Bar & Shield logo add a custom touch without the expense of a custom tank.

71282-04 **\$46.95**
Fits '06 FXD35, '07-'11 FXDC, '08-'10 FXDF and '04-'08 FXDWG models.

B. PREMIUM TANK PANEL WITH POUCH

This leather tank panel features an over-sized pouch for convenient at-your-fingertips storage. The heavy-duty leather pouch will maintain its shape for miles to come while the bold chrome Bar & Shield medallion sits proudly on the flap for all to admire.

91135-09 **\$127.95**
Fits '93-'08 FXDWG, '06 FXD35, '07-'17 FXDC and FXDF and '00-'17 Softail® models (except FLS, FLSS, FLSTNSE, FLSTSB, FLSTSE, FXCW, FXCWC, FXS, FXSB, FXSBSE, FXSE, FXSTD, FXSTSSE, '09-'17 FLSTC and '06 FLSTFSE). '93-'03 FXDWG models require the separate purchase of Clip P/N 10102 and O-Ring P/N 11174.

C. FRONT FENDER EXTENSION – CHROME

Dress your front fender in chrome. This chrome-plated tapered Fender Extension is shaped to follow the curve of the fender for style and function. Using the Original Equipment fender hole, the extension mounts below the trailing edge of the fender to help control road dirt and spray.

59664-03 **\$54.95**
Fits '91-'08 Dyna® and '84-'07 FX Softail models. Will not fit FXD, FXDX or FXDXT models equipped with Voltage Regulator Covers.

D. COIL COVER – CHROME

This sleek, Chrome Coil Cover features an innovative design that conceals all the mounting hardware. It offers a great, easy way to customize a very visible part of your Dyna motorcycles.

31709-04 **\$43.95**
Fits '04-'17 fuel-injected Dyna models.

E. LOWER BELT GUARD COVER – CHROME

Designed to cover the Original Equipment black lower debris deflector, this mirror chrome-finished cover adds an exceptional finish to the rear drive components. Kit includes required mounting hardware.

60514-07A Fits '07-'17 Dyna® models. **\$73.95**

Also available:

UPPER BELT GUARD – CHROME

Hand-polished and chrome-plated to replace your factory-equipped black upper belt guard.

60293-00 Fits '00-'05 Dyna models. **\$170.95**

F. BAR & SHIELD LOGO COIL COVER

Featuring a radical open-face design with a Bar & Shield silhouette, this Chrome Coil Cover matches the Chrome Voltage Regulator Cover for an integrated custom look. Includes all mounting hardware.

74616-04 **\$43.95**
Fits '04-'17 EFI Dyna and '01-'17 EFI equipped Softail models (except FXCW, FXCWC, FXS, FXSB, FXSBSE, FXSE and FXST-Aus).

G. VOLTAGE REGULATOR COVER

Designed for up-front style, the open face and floating Bar & Shield logo on this chrome cover provide good looks without compromising air flow across the voltage regulator. Kit includes chrome-plated mounting hardware.

74667-06 Fits '06-'11 Dyna models. **\$53.95**



A. DASH PANEL EXTENSION – CHROME



B. PREMIUM TANK PANEL WITH POUCH



C. FRONT FENDER EXTENSION – CHROME



D. COIL COVER – CHROME



E. CHROME UPPER AND LOWER BELT GUARDS



F. BAR & SHIELD LOGO COIL COVER



G. VOLTAGE REGULATOR COVER



H. MAGNUM 5 SPROCKET COVER – CHROME

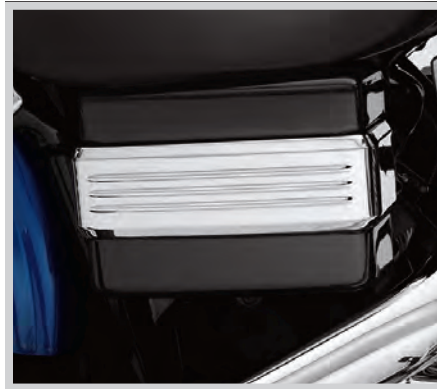

J. BATTERY COVER BAND – CHROME



L. ELECTRICAL PANEL TRIM – CHROME



I. BATTERY COVER – CHROME



K. BATTERY COVER BAND – HARLEY-DAVIDSON SCRIPT



M. ELECTRICAL PANEL COVER WITH TRIM – CHROME



N. BATTERY SIDE COVER – CHROME

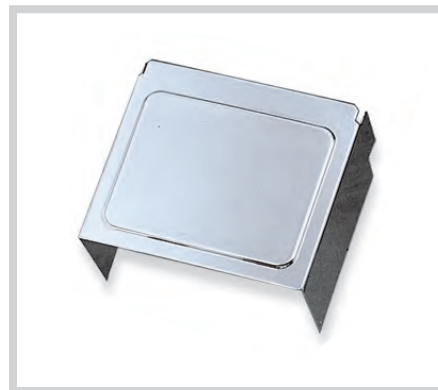

O. BATTERY COVERS – CHROME

CRUISER 103

Chassis Trim – Rear End

H. MAGNUM 5 SPROCKET COVER

Styled to match the distinctive Magnum 5 Custom Wheel. Available in mirror chrome or gloss black, this Sprocket Cover gives the appearance of having a custom sprocket at a fraction of the cost. Cover is easy to install with Original Equipment hardware or add the Chrome Hardware Kit P/N 94773-07 (sold separately) for a finished look.

Fits '07-'17 Dyna® models (except FLD).

40120-09 Chrome. **\$69.95**

I. BATTERY COVER – CHROME

Dress your battery with a new chrome skin. This one-piece Chrome Battery Cover replaces the painted box and adds a bright contrast to the Original Equipment satin aluminum trim band.

66375-06 **\$90.95**

Fits '06-'17 Dyna models (except FXDL). '14-'17 Dyna models require purchase of a battery cover trim band.

J. BATTERY COVER BAND – CHROME

This sweeping chrome band replaces the Original Equipment satin-finish band for a mirror-polished look. The easy-to-install ribbed chrome band is a high-contrast addition to a painted battery cover or the perfect finishing touch to the Chrome Battery Cover P/N 66375-06.

66439-07 **\$37.95**

Fits '06-'17 Dyna models (except FLD, FXDL, '13-'17 FXDB and '14-'17 FXDF). Also fits models equipped with Battery and Electrical Panel Cover Kit P/N 61300186.

K. BATTERY COVER BAND – HARLEY-DAVIDSON SCRIPT

Replace the Original Equipment satin aluminum trim band with a splash of chrome. This easy-to-install custom contoured trim band features a black-filled embossed Harley-Davidson script design and offers a stunning contrast to the factory painted battery cover or a great finishing touch for the Chrome Battery Cover P/N 66375-06 or 61300186.

66443-06 **\$43.95**

Fits '06-'17 Dyna models (except FLD, FXDL, '13-'17 FXDB and '14-'17 FXDF). Also fits models equipped with Battery and Electrical Panel Cover Kit P/N 61300186.

L. ELECTRICAL PANEL TRIM – CHROME

This sweeping chrome spear adds a mirror-polished accent to your bike's profile. The easy-to-install band is a high-contrast addition to the Original Equipment painted electrical panel cover or the perfect finishing touch on a Chrome Cover.

66462-07 **\$48.95**

Fits '04-'17 Dyna models (except '06 FXD35, '04-'13 FXDL, '17-later FXDLS and '04-'08 FXDWG models with Original Equipment electrical panel cover).

M. ELECTRICAL PANEL COVER WITH TRIM – CHROME

Chrome-plated Electrical Panel Cover with concealed mounting hardware provides a nice clean look. Kit includes panel cover, distinctive chrome-plated die-cast trim with black accented lines and Bar & Shield logo and all necessary mounting hardware.

66426-04 Fits '04-'11 Dyna models. **\$90.95**

N. BATTERY SIDE COVER – CHROME*

This chrome-plated cover is designed for use with the new Harley-Davidson® AGM sealed maintenance-free batteries and can be used in combination with Battery Top Cover P/N 66367-97 or 66368-97.

66718-01 **\$54.95**

Fits '97-'03 XL and '97-'05 Dyna® models.

O. BATTERY COVERS – CHROME*

Chrome-plated battery enclosures include slotted openings for convenient visual check of battery fluid levels. Easy installation.

66375-97 **\$74.95**

Fits '97-'05, '97-'05 FXD, '99-'05 FXDX and '01-'03 FXDXT models. Stock on FXDL, FXDWG and FXDS-CONV. models.

*NOTE: Battery dimensions of Harley-Davidson AGM Batteries P/N 65989-97A, 65989-90B and 65991-82B may not allow use of accessory battery side covers on XL and Dyna models.

Notice: The prices appearing in this catalog are the manufacturer's suggested retail prices. Actual retail prices may vary.

Notice: The prices appearing in this catalog are the manufacturer's suggested retail prices. Actual retail prices may vary.

DYNA

COASTAL PACKAGE – SOFTAIL® STANDARD/STREET BOB®

Kickstart your customization journey and make it as seamless as possible with the Coastal Custom Package from H-D® Genuine Parts & Accessories. From the quarter fairing and moto bar to the slotted footpegs and deep solo seat, this package is all about sleek lines and performance-oriented style.

Includes: Vivid Black Softail® Quarter Fairing, Endgame Rider Footpegs, Moto Bar, Tall Handlebar Riser, Get-a-Grip Hand Grips. Available exclusively in Dealerships – See your Dealer for details.

50700095

\$1,743.95

Fits '20-later FXST, '18-later FXBB and '21-later FXBBS models.



Notice: Some Kit items not shown: Kit may include additional components required for complete installation.

COASTAL PACKAGE – LOW RIDER® S

Kickstart your customization journey and make it as seamless as possible with the Coastal Custom Package from H-D® Genuine Parts & Accessories. From the quarter fairing and moto bar to the slotted footpegs and deep solo seat, this package is all about sleek lines and performance-oriented style.

Includes: Bevel Solo Seat, Vivid Black Quarter Fairing Kit, Quarter Fairing Bracket Kit, End-Game Rider Footpegs, Flat-Out Bar. Available exclusively in Dealerships – See your Dealer for details.

50700096

\$1,724.95

Fits '20-later FXLRS models. Seat width 12.75". Does not fit with passenger pillions.



Notice: Some Kit items not shown: Kit may include additional components required for complete installation.

LONG-HAUL PACKAGE – STREET BOB

Kickstart your customization journey and make it as seamless as possible with the Touring Custom Package from H-D® Genuine Parts & Accessories. Ready to roam. A Street Bob® motorcycle equipped for a longer road, with added comfort for rider and passenger. Detachable luggage, sissy bar and windshield for a quick conversion back to cruiser mode.

Includes: H-D® Detachables™ Saddlebags, HoldFast Docking Hardware Kit, HoldFast Sissy Bar Upright, Passenger Backrest Pad, Sundowner® Seat, Wind Splitter Quick-Release Compact 14 in. Windshield. Available exclusively in Dealerships – See your Dealer for details.

50700093

\$2,192.95

Fits '18-later FXBB and FXBBS models. Seat width 14.25"; passenger pillion width 10.0"



Notice: Some Kit items not shown: Adversary Shifter Peg, Adversary Hand Grip End Cap and Black Velocity Stack. Kit may include additional components required for complete installation. The prices appearing in this catalog are the manufacturer's suggested retail prices. Actual retail prices may vary.

COASTAL PACKAGE – LOW RIDER ST

Kickstart your customization journey and make it as seamless as possible with the Coastal Custom Package from H-D® Genuine Parts & Accessories. High-performance audio combined with West Coast style details make for a soulful ride.

Includes: Endgame Rider Footpegs, Flat-Out Bar- Black, Low Rider ST Tip-over Bar Bracket, H-D® Audio by Rockford Fosgate® - Inner Fairing Audio Kit. Available exclusively in Dealerships – See your Dealer for details.

50700097

\$1,621.95

Fits '22-later FXLRST models.



Notice: Some Kit items not shown: Adversary Shifter Peg, Adversary Hand Grip End Cap and Black Velocity Stack. Kit may include additional components required for complete installation. The prices appearing in this catalog are the manufacturer's suggested retail prices. Actual retail prices may vary.

106 CRUISER

Color-Matched Quarter Fairing

A. SOFTAIL® QUARTER FAIRING

This street performance-inspired Quarter Fairing is designed to reduce drag while providing a sleek, custom look. With a Dark Smoke windscreen featuring a Harley-Davidson script on the lower leading edge, it provides the wind protection you need to go all day while looking sinister in the process.

Fits '18-later FXBB and FXLR, '20-later FXLRS, FXST and '21-later FXBBS models. Requires separate purchase of model specific Fairing Bracket Kit. FXBB models require separate purchase of Turn Signal Brackets P/N 12700164 and 67800630 and Hardware P/Ns 67015-02 (qty 2), 7155 (qty 1) and 7331 (qty 1). Does not fit FXBB or FXLR models equipped with Moto Bar P/Ns 55800856 or 55800858 when using Original Equipment handlebar risers. FXLR models equipped with Moto Bar P/Ns 55800856 or 55800858 and Tall Risers P/N 55800852 or 55800854 require separate purchase of Turn Signal Brackets P/N 12700164 and 67800630.

57001627	Raw.	\$336.95
57001615DH	Vivid Black.	\$532.95
57001615EGZ	Gunship Gray.	\$560.95
57001615EKP	Billiard Blue.	\$560.95
57001615EKR	Barracuda Silver.	\$560.95
57001615ENR	Barracuda Silver Denim.	\$560.95
57001615ENT	River Rock Gray.	\$560.95
57001615ENX	Billiard Red.	\$560.95
57001615EOB	Stone Washed White Pearl.	\$560.95
57001615EOG	Spruce.	\$560.95
57001615EUZ	Redline Red.	\$560.95
57001615EVC	Fastback Blue.	\$560.95
57001615EVD	White Sand Pearl.	\$509.95
57001615EXE	Industrial Yellow.	\$509.95

B. SOFTAIL QUARTER FAIRING BRACKET KIT

This matte black bracket kit is required for mounting the Quarter Fairing to your motorcycle.

57001249 **\$114.95**
Fits '18-later FXBB, FXBBS, FXLR and FXST. FXBB, FXBBS and FXST installation requires separate purchase of Turn Signal Brackets P/Ns, 12700164 and 67800630 and Hardware P/Ns 67015-02 (qty 2), 7155 (qty 1) and 7331 (qty 1). FXLR models with Tall Risers/Moto Bars require separate purchase of Turn Signal Brackets P/Ns 12700164 and 67800630 and Hardware P/N 67015-02 (qty 2).

57001250 **\$114.95**
Fits '20-later FXLRS models. Does not fit FXLRS models with Tall Risers and Moto Bars. Also compatible with 5.75" Headlight Bucket P/N 67700380, Trim Ring, Screw and Lock Nut P/N 67700375, 3383 and 7606.



A. SOFTAIL QUARTER FAIRING



B. SOFTAIL QUARTER FAIRING BRACKET KITS

Notice: The prices appearing in this catalog are the manufacturer's suggested retail prices. Actual retail prices may vary.

CRUISER 107

DEFY THE WIND

At highway speed, you take the wind full-force in the chest, causing fatigue in your arms, neck and shoulders.

Take the pressure off with an easy-to-install detachable windshield.

Shaped to divert air, rain and road debris around the rider, a windshield can add hours of riding comfort.

KEEPING YOU COVERED

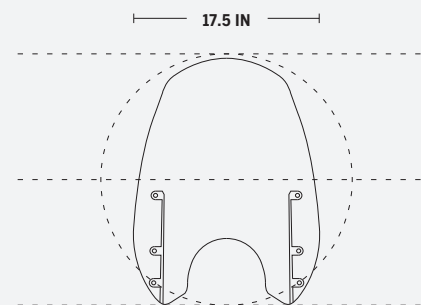

SUPER SPORT

Eliminates wind and debris, but keeps the wind-in-the-hair feeling. Ideal for a cool morning ride to the office, the sleek profile hugs the front lamps for a sporty look.

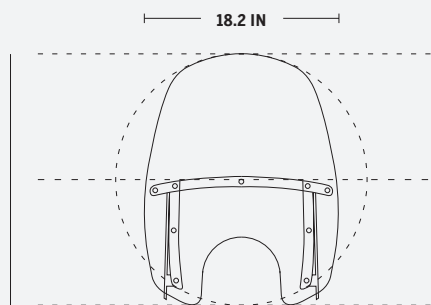

COMPACT

Traditional king-sized shape with a minimalist edge. For Harley-Davidson® custom and cruiser models, the Compact windshield provides wind and weather protection for every day riding.

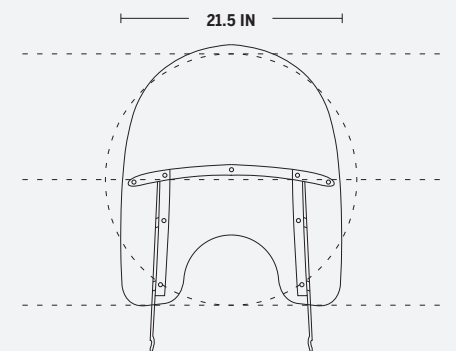

KING SIZE

Nothing gets past this one. The King Size windshield is the ultimate in on-road protection. Available in a variety of shield heights, the road can't lay a finger on you.

READY FOR TAKE-OFF

Designed to be installed or removed without tools in seconds, a detachable windshield gives you the freedom to define your ride at the drop of a hat. Ride across the country protected from the elements, then quickly remove the windshield to hit the streets in style.



To avoid looking through bug spots, condensation and road grime, select a windshield that tops out just below your line of sight.

WIND SPLITTER FLIP

Shaped for effective airflow management, Wind Splitter windshields feature a "flip" at the upper edge to help reduce helmet buffeting at speed.

SCRATCH-RESISTANT HARD-COATED POLYCARBONATE SHIELD

STAINLESS STEEL BRACKETS & BRACES

NO TOOLS QUICK-RELEASE MOUNT

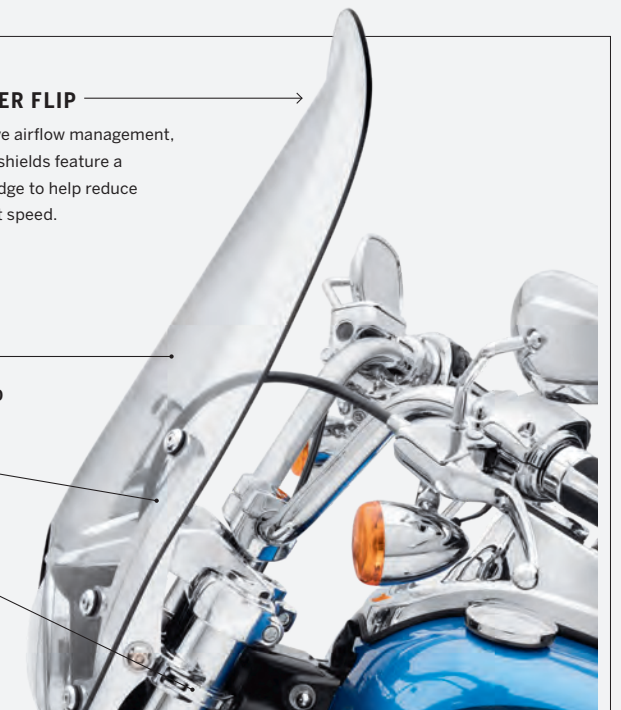

108 CRUISER

Windshields – Super Sport

A. WIND SPLITTER QUICK-RELEASE SUPER SPORT WINDSHIELD

Shaped with just the right mix of width and height to reduce the pounding air pressure against your chest, the Wind Splitter Super Sport Windshield allows you ride comfortably while maintaining the wind-in-the-hair feeling. The windshield's contoured design incorporates a flipped upper edge that manages airflow and turbulence across the top of the shield. The flip adds additional wind shear lift, and effectively provides the protection of a taller windscreen. Ideal for a cool morning ride, the sleek profile of the Super Sport Windshield hugs the front headlamp for a sporty look. And because the windshield mounts to the fork tubes with elegant die-cast lever-locking clamps, you get quick on-and-off convenience and a clean, custom look. Kit includes the hard-coated polycarbonate screen, brackets and quick-release docking clamps.

57400323 19" Light Smoke – Polished. **\$400.95**
Fits '18-later FXBB, FXLR, '14-'17 FXDL, '20-later FXST and '21-later FXBBS models. Does not fit FXLRS. Windshield dimensions: Overall height – 24.4"; width – 17.5".

57400334 19" Light Smoke – Polished. **\$400.95**
Fits '18-later FXBR and FXBRS models. Windshield dimensions: Overall height – 24.4"; width – 17.5".

B. QUICK-RELEASE SUPER SPORT WINDSHIELD

Reduces the pounding of wind and shower of bugs, but keeps the wind-in-the-hair feeling. Ideal for a cool morning ride, the sleek profile of the Super Sport Windshield hugs the front headlamp for a sporty look. The windshield mounts to the fork tubes with elegant die-cast lever locking clamps, so the windshield does not require any "leave-behind" docking hardware. You get quick on-and-off convenience and a clean, custom look. No tools are required and the kit includes everything needed to install the windshield.

57300-06 19" Light Smoke. **\$406.95**
Fits '06-'17 Dyna® (except FLD, FXDWG, FXDF and FXDSE) and '18-later Softail® FXBB, FXBBS, FXLR and FXST models. FXDLS models require the removal of Original Equipment Wind Deflector. Windshield dimensions: Overall height-25.0"; width-20.1".

57301-06 19" Light Smoke. **\$406.95**
Fits '06-'17 FXDWG, '13-'17 FXSB and FXSBSE and '18-later FXBR and FXBRS models. Windshield dimensions: Overall height – 25.0"; width – 20.1".



A. WIND SPLITTER QUICK-RELEASE SUPER SPORT WINDSHIELD
(57400323 SHOWN)



B. QUICK-RELEASE SUPER SPORT WINDSHIELD
(57300-06 SHOWN)



C. WIND SPLITTER QUICK-RELEASE COMPACT WINDSHIELD
(57400327 SHOWN)



D. QUICK RELEASE COMPACT WINDSHIELD
(58346-06 SHOWN)

CRUISER 109

Windshields – Compact

C. WIND SPLITTER QUICK-RELEASE COMPACT WINDSHIELD

Engineered to provide the riding comfort of a larger windshield, this Wind Splitter Windshield features a contemporary contour that sets it apart from the crowd. The compact shape is designed to keep the windshield below your line of sight so you don't need to look through bugs and road grime, while the flipped upper edge manages airflow and turbulence across the top of the shield. The flip adds additional wind shear lift to provide the protection of a taller windscreen. You get a fatigue-free highway ride with reduced pressure on your chest and arms, and the detachable design means you can ride without the shield when the mood strikes. The hard-coated polycarbonate windshield mounts to the fork tubes with elegant die-cast lever-release clamps, so the windshield does not require any leave-behind docking hardware. You get quick on-and-off convenience and a clean, custom look. No tools are required and the kit includes everything needed to install the windshield.

Fits '18-later FXBB, FXBBS, FXLR, FXST and '14-'17 FXDL models. Does not fit FXLRS.

57400327 18" Clear – Polished. **\$426.95**
Windshield dimensions: Overall height – 23.4"; width – 17.6".

57400337 18" Light Smoke – Polished. **\$482.95**
Windshield dimensions: Overall height – 23.4"; width – 17.6".

57400331 14" Light Smoke – Polished. **\$461.95**
Windshield dimensions: Overall height – 19.5"; width – 17.6".

Fits '18-later FXBR and FXBRS models.

57400336 14" Light Smoke – Polished. **\$461.95**
Windshield dimensions: Overall height – 19.5"; width – 17.6".

D. QUICK-RELEASE COMPACT WINDSHIELD

This tough, hard-coated polycarbonate Windshield wraps around the headlamp to offer the maximum wind protection available in a compact profile. The windshield mounts to the fork tubes with diecast lever-release clamps so the windshield does not require any leave behind hardware. You get quick on-and-off convenience and a clean, custom look. No tools are required.

Fits '06-'17 Dyna® (except FLD, FXDWG, FXDF and FXDSE) and '18-later FXBB, FXBBS, FXLR and FXST models. FXDLS models require the removal of Original Equipment Wind Deflector.

58346-06 18" Clear – Polished. **\$435.95**
Windshield dimensions: Overall height – 26.8"; width – 19.7".

58348-06 14" Light Smoke – Polished. **\$440.95**
Windshield dimensions: Overall height – 22.8"; width – 19.5".

Fits '06-'17 FXDWG, '13-'17 FXSB and FXSBSE and '18-later FXBR and FXBRS models.

58387-06 18" Clear – Polished. **\$411.95**
Windshield dimensions: Overall height – 26.8"; width – 19.5".

58444-06 14" Light Smoke – Polished. **\$416.95**
Windshield dimensions: Overall height – 22.8"; width – 19.5".

110 CRUISER

Windshields – Compact

A. WIND SPLITTER DETACHABLE COMPACT WINDSHIELD

Shaped to divert headwinds around the rider, this compact windshield moderates the air pressure against your chest and reduces the strain on your arms during a long highway ride. Designed to provide the riding comfort of a larger windshield, this Wind Splitter Windshield features flipped upper edge to manage the airflow and turbulence across the top of the shield. The flip adds additional wind shear lift to provide the protection of a taller windscreen. The compact size is the perfect compromise between function and style on the road, and the detachable design means you can ride without the shield when you prefer a wind-in-the-hair experience. The hard-coated polycarbonate windshield mounts to the fork triple trees with rubber isolators to reduce vibration and to provide quick tool-free on-and-off installation. Kit includes all mounting hardware.

Fits '18-later FLFB and FLFBS models.

57400368 19" Clear – Polished. **\$450.95**
Windshield dimensions: Overall height – 23.2"; width – 18.9".

57400367 15" Light Smoke – Polished. **\$456.95**
Windshield dimensions: Overall height – 17.8"; width – 18.5".

Fits '18-later FXFB and FXFBS models.

57400324 19" Clear – Black. **\$477.95**
Windshield dimensions: Overall height – 23.2"; width – 18.9".

57400330 15" Light Smoke – Black. **\$482.95**
Windshield dimensions: Overall height – 17.8"; width – 18.5".

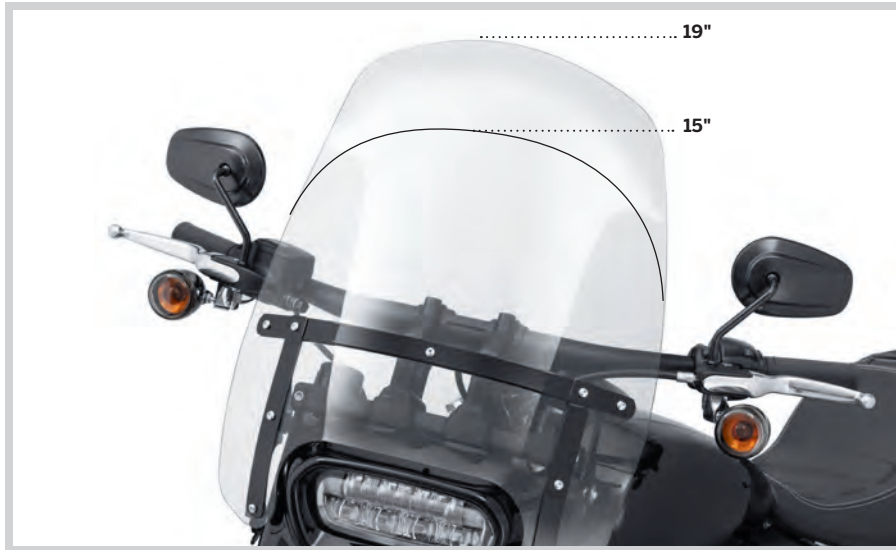

A. WIND SPLITTER DETACHABLE COMPACT WINDSHIELD (57400324 SHOWN)



B. LIGHT SMOKE WINDSHIELD – 10"



C. ST WIND DEFLECTOR

Notice: The prices appearing in this catalog are the manufacturer's suggested retail prices. Actual retail prices may vary.

CRUISER 111

Windshields – King Size

D. KING-SIZE H-D® DETACHABLES™ WINDSHIELD

Nothing gets past this one. The King Size windshield is the ultimate in on-road protection. This full coverage shield creates a clean managed flow of air over and around the rider and passenger, and because it is designed to be installed or removed in seconds without tools, a detachable windshield gives you the freedom to define your ride at the drop of a hat. Ride across the country protected from the elements, then quickly remove the windshield to hit the streets in style. This one-piece windshield is formed from hard-coated polycarbonate material to resist scratching. The shield is attached to stainless steel mounting brackets supported by molded-rubber bushings for improved isolation. Windshields are available in a variety of heights to match your size, and with traditional polished or contemporary gloss black braces to match your bike's finishes. Kit includes mounting hardware.

Fits '18-later FLDE, FLHC and FLHCS models.

57400328 21" Clear – Polished. **\$421.95**
Windshield dimensions: Overall height – 26.8"; width – 21.4".

57400332 18" Clear – Polished. **\$405.95**
Windshield dimensions: Overall height – 23.8"; width – 21.5".

Fits '18-'21 FLSL models.

57400369 21" Clear – Black. **\$445.95**
Windshield dimensions: Overall height – 28.6"; width – 21.4".

57400335 18" Clear – Black. **\$426.95**
Windshield dimensions: Overall height – 23.8"; width – 21.5".



D. KING-SIZE H-D DETACHABLES WINDSHIELD (DELUXE MODEL SHOWN)



E. KING-SIZE NOSTALGIC H-D DETACHABLES WINDSHIELD (DELUXE MODEL SHOWN)



F. SPORT GLIDE WINDSHIELD

E. KING-SIZE NOSTALGIC H-D DETACHABLES WINDSHIELD

A windshield provides a barrier between the rider and errant bugs, discarded cigarette butts, flying debris and bad air. The shield manages airflow and wind blasts to create a pocket of still air for both rider and passenger comfort. But it's not just about function. This one-piece windshield features a nostalgic horseshoe-shaped outer brace that is the perfect match for your classic Harley-Davidson® motorcycle. Formed from hard-coated polycarbonate to resist scratching, this tall windshield provides maximum protection on the highway, but when you want to ride "naked," the detachable shield can be removed completely or reinstalled in seconds to match your riding mood. Kit includes mounting hardware.

57400329 21" Clear – Polished. **\$434.95**
Fits '18-later FLDE, FLHC and FLHCS models. Windshield dimensions: Overall height – 27.0"; width – 21.5".

F. SPORT GLIDE® WINDSHIELD

Style meets function. This 5.5" tall Windshield stands 4" taller than the Original Equipment Sport Glide wind deflector to offer sport styling with a little greater wind protection. The taller shield moves more air up and over the rider to reduce helmet buffeting and wind-related fatigue. Harley-Davidson® windshields are formed of hard-coated polycarbonate for strength and scratch resistance and the light smoke tint complements any paint color.

57400360 5.5" Light Smoke. **\$168.95**
Fits '18-'21 FLSB models.

Also available:

TRANSPARENT PAINT GUARD KIT – SPORT GLIDE

This transparent skin is designed to protect your paint from bugs, boot scuffs and road debris. The crystal-clear material protects the paint without changing the overall look of your bike. And the optical properties of the material disguise minor scuffs and scratches. The application process is similar to that of tinted window film and the material can be removed and replaced when it is no longer cosmetically appealing. Scratches to paint can be expensive to repair but scratches to this film can be removed by applying a small amount of heat with a heat gun.

Fits '18-'21 FLSB and '22-later FXLRST and FXRST models. Not recommended for use on denim or aftermarket paint.

11100225 Fairing. **\$90.95**
11100222 Saddlebags. **\$74.95**

Notice: The prices appearing in this catalog are the manufacturer's suggested retail prices. Actual retail prices may vary.

SOFTAIL

ENJOY THE RIDE

The relationship between the seat, the handlebar and the foot controls has an enormous impact on the comfort, control and confidence you feel when riding your motorcycle. Once you've picked the bike, it's time to choose the options that match your ride to your personal dimensions.



For shorter riders, consider tailoring your fit by changing to a Reach® Seat, Mid-Foot Controls, and lowered suspension height.



For taller riders, consider altering your ride by changing to a Tallboy® Seat and Extended Foot Controls.

ESTABLISH YOUR POSITION AND FEEL

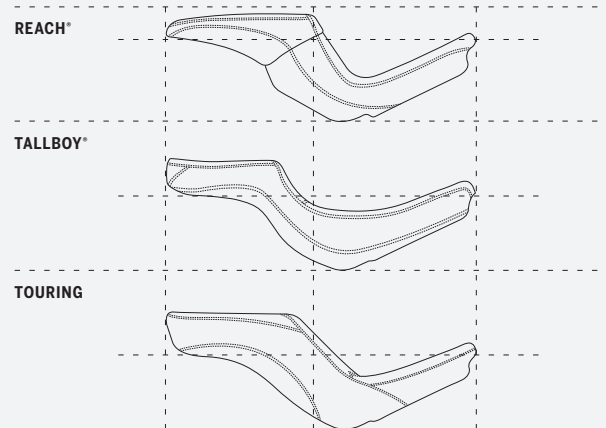

SEATS

Seat height and shape impact rider comfort, fit and confidence. Where the seat positions you relative to the foot controls, hand controls and the ground plays a major role in the quality of your ride.

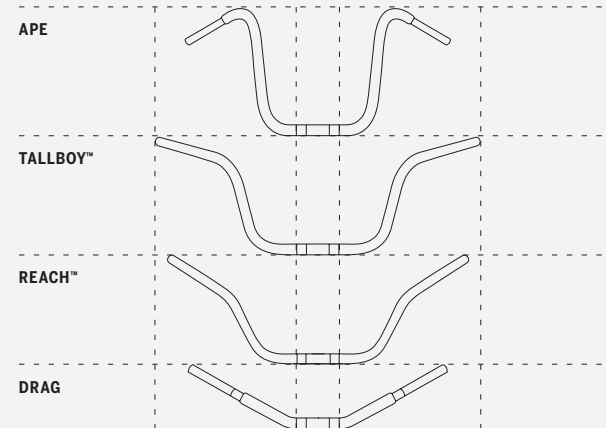

HANDLEBARS

Where the bar positions your arms, hands and wrists directly impacts how you feel on the motorcycle. Choose a bar that falls easily to hand, and does not pull you out of the seat when maneuvering.

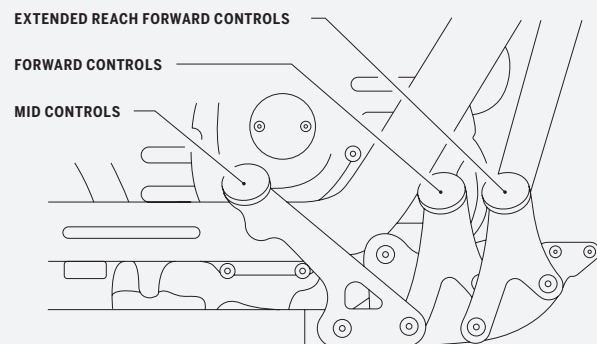

FOOT CONTROLS

Repositioning your feet can relieve muscle tension, take pressure off the tailbone and reduce fatigue. The correct riding position can add hours of comfort and hundreds of miles to your daily saddle time.

LOW HEIGHT

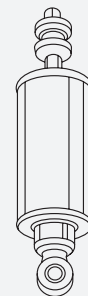

SUSPENSION

Adjusting your motorcycle's ride height by raising or lowering the suspension is often the first step in fitting the bike to your stature. Being sure-footed at a stop can really increase your sense of confidence.



A. BEVEL SOLO SEAT



B. BEVEL TWO-UP SEAT



C. BEVEL PASSENGER PILLION (52400197 SHOWN)



C. BEVEL PASSENGER PILLION (52400196 SHOWN)

A. BEVEL SOLO SEAT

You make zero compromises when it comes to style so you're not about to trade looks for comfort. And why should you? Now you can have the best of both worlds and no one needs to know. The Bevel Seats were created with all the attitude to suit your styling direction while providing all the function without the bulky look of a comfort seat. The low, slim profile of the Bevel Seats complement the lines of your bike while the carbon fiber-like inserts, chevron-shaped pleating, HDMC embroidered script and edgy aluminum button detail, that your back end won't feel, add a custom look. What nobody sees but makes any ride better is the lightweight and breathable 3D mesh material. 3D mesh absorbs the impact of even the worst roads even though the material is significantly thinner than comparable seats. Taped seams provide water resistance to keep your back end dry even when the seat is wet and, the "bevel" at the back of the seat adds to the rider's lower back comfort.

52000391 \$425.95
Fits '18-later FXFB and FXFBS models. Seat width 11.5".

B. BEVEL TWO-UP SEAT

You make zero compromises when it comes to style so you're not about to trade looks for comfort. And why should you? Now you can have the best of both worlds and no one needs to know. The Bevel Seats were created with all the attitude to suit your styling direction while providing all the function without the bulky look of a comfort seat. The low, slim profile of the Bevel Seats complement the lines of your bike while the carbon fiber-like inserts, chevron-shaped pleating, HDMC embroidered script and edgy aluminum, "no-fee!" button detail, that your back end won't feel, add a custom look. What nobody sees but makes any ride better is the lightweight and breathable 3D mesh material. 3D mesh absorbs the impact of even the worst roads even though the material is significantly thinner than comparable seats. Taped seams provide water resistance to keep your back end dry even when the seat is wet and, the "bevel" at the back of the seat adds to the rider's lower back comfort.

52000400 \$478.95
Fits '18-later FXBB, '20-later FXST and '21-later FXBBS models. Seat width 12.5"; passenger pillion width 7.0".

C. BEVEL PASSENGER PILLION

Let your passenger ride in comfort without giving up all the attitude you've styled your bike to have. Taped seams provide water resistance to keep your passenger's back end dry even when the seat is wet. Styled to match the Bevel Solo Seat.

52400196 FXDR 114 Styling. \$245.95
Fits '19-'20 FXDRS models equipped with Bevel Solo Seat P/N 52000390. Passenger pillion width 9.25".

52400197 FXFB Styling. \$245.95
Fits '18-later FXFB and FXFBS models equipped with Bevel Solo Seat P/N 52000391. Passenger pillion width 6.75".



3D Mesh Technology



Water-Resistant Seams

Notice: The prices appearing in this catalog are the manufacturer's suggested retail prices. Actual retail prices may vary.

114 CRUISER

Seating – Reach®

REACH® SOLO SEATS

From the custom metal Harley-Davidson® medallion to the sleek fast-back design, this seat is shaped to deliver the ergonomic position that a shorter rider needs. Sculpted and molded to ease the reach to the ground, this Reach® Solo seat positions the rider closer to the controls when compared to the stock seat. The narrow nose and the seating position provides the rider with added confidence and control while the bike is at a stop or during parking maneuvers, while the generous seating width adds support for the long haul. And the seat's upturned tail keeps you in place without confining you to one position. For maximum comfort and support, these seats are recommended for riders between 5'-2" and 5'-8" tall.

A. REACH SOLO SEAT – DELUXE STYLING

Styled to complement the classic looks of the Softail® Deluxe model, this Reach Solo Seat features double-row stitching down the center of the seating surface, and premium leather valance side panels with decorative inserts. Matching Passenger Pillion P/N 52400175 is available.

Measurements as compared to other seating options:

- Stock '18 Deluxe model seat – 1.5" forward
- Stock '18 Heritage model seat – 1.5" forward

52000302 **\$307.95**
Fits '18-later FLDE, FLHC and FLHCS models. Does not fit with FLHC or FLHCS Original Equipment passenger pillion. Seat width 14.5".

B. REACH SOLO SEAT – SOFTAIL SLIM® STYLING

This minimalistic Reach Solo Seat features a classic tuck & roll design that perfectly complements the bobber style of the Softail Slim® models. Matching Passenger Pillion P/N 52400129 is available.

Measurements as compared to other seating options:

- Stock '18 Softail Slim model seat – 1.25" forward.

52000303 **\$307.95**
Fits '18-'21 FLSL models. Seat width 11.5".

C. REACH SOLO SEAT – '18 BREAKOUT STYLING

This comfortable Reach Solo Seat is styled to match the Softail Breakout® model's Original Equipment seat and features rich red stitching, a textured vinyl inlay and Harley-Davidson medallion insert. The seating surface and stitching complements the model year '18 Original Equipment passenger pillion.

Measurements as compared to other seating options:

- Stock '18 Breakout model seat – 1.5" forward.

52000304 Red Stitching. **\$307.95**
Fits '18-later FXBR and FXBRS models equipped with Original Equipment passenger pillion or Sundowner™ Pillion P/N 52400225 or 52400169. Seat width 13.0".

D. REACH SOLO SEAT – '19-'20 BREAKOUT STYLING

This comfortable Reach Solo Seat is styled to match the Softail Breakout model's Original Equipment seat and features grey stitching, a textured vinyl inlay and Harley-Davidson medallion insert. The seating surface and stitching complements the model year '19 Original Equipment passenger pillion.

Measurements as compared to other seating options:

- Stock '19 Breakout model seat – 1.5" forward.

52000430 Grey Stitching. **\$307.95**
Fits '18-later FXBR and FXBRS models equipped with Original Equipment passenger pillion or Sundowner Pillion P/N 52400225 or 52400169. Seat width 13.0".



A. REACH SOLO SEAT – DELUXE STYLING



B. REACH SOLO SEAT – SOFTAIL SLIM STYLING



C. REACH SOLO SEAT – '18 BREAKOUT STYLING, RED STITCH (SHOWN WITH ORIGINAL EQUIPMENT PILLION)



D. REACH SOLO SEAT – '19 BREAKOUT STYLING, GREY STITCH



E. REACH SOLO SEAT – FXDR 114 STYLING



F. REACH SOLO SEAT – FAT BOY STYLING (SHOWN WITH ORIGINAL EQUIPMENT PILLION)



G. REACH TWO-UP SEAT – SPORT GLIDE STYLING



H. REACH TWO-UP SEAT – FAT BOB STYLING

CRUISER 115

Seating – Reach®

E. REACH® SOLO SEAT – FXDR 114 STYLING

This Reach® Solo Seat puts you closer to the controls without sacrificing the FXDR™ 114 model's head-turning style. Designed to position riders with a shorter inseam closer to the ground, Reach Seats are shaped to place the rider in a comfortable and confident relationship to the hand and foot controls. Compared to the stock seat, the Reach seat moves the rider approximately 1.5" forward bringing the legs closer together for an easier reach to the controls and the ground. Reach Seats feature a stepped profile that provides back support and keeps the rider from sliding back during acceleration. This Reach Solo Seat is styled to match the FXDR 114 model's Original Equipment seat.

Measurements as compared to other seating options:

- Stock FXDRS model seat – 1.5" forward.

52000398 **\$307.95**
Fits '19-'20 FXDRS models. Seat width 11.5".

F. REACH SOLO SEAT – FAT BOY STYLING

This Reach Solo Seat puts you closer to the controls without sacrificing the Fat Boy® model's head-turning style. The seat features stitching and seat textures are a perfect match for the Original Equipment passenger pillion.

Measurements as compared to other seating options:

- Stock '18 Fat Boy model seat – 1.0" forward.

52000352 **\$307.95**
Fits '18-later FLFB and FLFBS models equipped with Original Equipment passenger pillion or Sundowner™ Pillion P/N 52400170. Seat width 14.0".

REACH TWO-UP SEATS

Designed to position riders with a shorter inseam closer to the ground, Reach Two-Up Seats are shaped to place the rider in a comfortable and confident relationship to the hand and foot controls. The wide seating surface provides loads of support and the narrow tapered nose brings the rider's legs together for an easier reach to the ground at a stop. These Reach Two-Up Seats feature a stepped profile that keeps the rider from sliding rearward during acceleration, and a generous raised passenger position that cradles the tailbone for hours of riding comfort. The rich vinyl seating surface is accented with a classic Harley-Davidson® medallion.

G. REACH TWO-UP SEAT – SPORT GLIDE STYLING

Designed to look like a separate solo seat and pillion, this smooth vinyl one-piece Reach Two-Up Seat perfectly complements the sweeping lines of the Low Rider® model.

Measurements as compared to other seating options:

- Stock '18 Low Rider model seat – 0.5" lower, 1.5" forward.

52000354 **\$413.95**
Fits '18-later FLSB, FXLR, FXLRS, FXLRST and FXRST models. Seat width 12.0"; passenger pillion width 5.5".

H. REACH TWO-UP SEAT – FAT BOB STYLING

Designed to reflect the technical style of the Original Equipment Fat Bob® seat, this Reach Two-Up seat features textured suede-like seating surfaces for grip, and raised center panels for a tough, tactical look.

Measurements as compared to other seating options:

- Stock '18 Fat Bob model seat – 0.5" lower, 1.25" forward.

52000353 **\$413.95**
Fits '18-later FXFB and FXFBS models. Seat width 11.0"; passenger pillion width 6.0".



Reach Seats

Notice: The prices appearing in this catalog are the manufacturer's suggested retail prices. Actual retail prices may vary.

Notice: The prices appearing in this catalog are the manufacturer's suggested retail prices. Actual retail prices may vary.

SOFTAIL

116 CRUISER

Seat – Tallboy®

TALLBOY® TWO-UP SEATS

The correct riding position can help a tall rider sit comfortably on the bike and avoid leg cramps and back strain during a long day in the saddle. For riders with a longer inseam, a Tallboy® Seat moves the rider up and back from the stock seating position to eliminate the “knees-high” riding position and effectively place the body for a natural arm and leg reach to the controls. Tallboy Seats feature a bucket-shaped design and a wide seating surface to reduce pressure on the rider’s tailbone, without looking bulky or overstuffed. And the passenger pillion is shaped and padded to maximize passenger comfort. The rich vinyl seating surface is accented with a round Harley-Davidson® medallion.

A. TALLBOY TWO-UP SEAT – DELUXE, HERITAGE, SOFTAIL SLIM® AND STREET BOB®

Measurements as compared to other seating options:

- Stock '18 Deluxe model seat – 2.5" rearward, 1.0" higher.
- Stock '18 Heritage model seat – 2.5" rearward, 1.0" higher.
- Stock '18 Softail Slim® model seat – 1.75" rearward, 1.75" higher.
- Stock '18 Street Bob® model seat – 2.5" rearward, 1.0" higher.

52000355 \$413.95

Fits '18-later FLDE, FLHC, FLHCS, FLSL, FXBB, FXBBS and FXST models. Seat width 14.5"; passenger pillion width 9.75".

B. TALLBOY TWO-UP SEAT – LOW RIDER®

Measurements as compared to other seating options:

- Stock '18 Low Rider® model seat – 2.75" rearward, 1.0" higher.

52000305 \$413.95

Fits '18-later FLSB, FXLR, FXLRS, FXLRST and FXRST models. Seat width 14.5"; passenger pillion width 9.0".



A. TALLBOY TWO-UP SEAT – DELUXE, HERITAGE, SOFTAIL SLIM AND STREET BOB



B. TALLBOY TWO-UP SEAT – LOW RIDER



Tallboy Seats

Notice: The prices appearing in this catalog are the manufacturer's suggested retail prices. Actual retail prices may vary.

CRUISER 117

Seating – Hammock

C. HARLEY® HAMMOCK TOURING SEATS

Stay in the saddle all day. These Harley® Hammock seats feature broad seating surfaces and a shallow bucket shape to distribute the weight and reduce pressure points. Beneath the 2" of traditional dual-density foam, the rider's weight is supported by a revolutionary fabric suspension system. The sling-like suspension system is integrated into the seat and acts like a hammock, providing 2" of suspension above the seat pan. This internal system prevents bottoming out and provides a 30% improvement in comfort and endurance over the long haul by sheltering the rider from pothole and highway expansion joint impacts. The seat's diamond-stitched vinyl surface is easy to clean and maintain, and it can be equipped with an optional Rider Backrest for additional back support.

52000294 \$563.95

Fits '18-later FLFB, FLFBS, FXBR and FXBRS models. Seat width 16.5"; passenger pillion width 10.75".

52000290 \$563.95

Fits '18-later FLDE, FLHC, FLHCS, FLSL, FXBB, FXBBS and FXST models. Seat width 16.0"; passenger pillion width 11.25".

Shown with:

ADJUSTABLE RIDER BACKREST

Add back support for long-haul riding comfort. This contoured backrest pad is shaped to provide full lower back support without pushing the rider forward and the slim profile maximizes the available passenger space. An adjustable support bracket with four mounting locations accommodates different seats and riding positions. The backrest pad angle can be adjusted for maximum comfort.

52300409 \$160.95

Fits '18-later FLDE, FLHC, FLHCS, FLSL, FXBB, FXBBS, FLFB, FLFBS, FXBR, FXBRS, FXLRS, FXLRST and FXST models equipped with Signature Hammock Seat P/N 52000290 or 52000294. Backrest pad width 11.25".

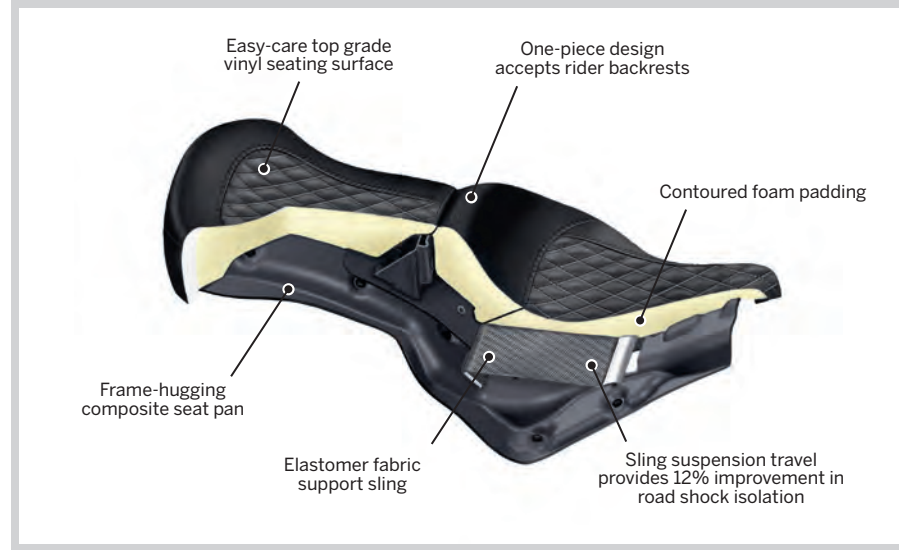

C. HARLEY HAMMOCK TOURING SEAT



C. HARLEY HAMMOCK TOURING SEATS (FAT BOY MODEL SHOWN)



C. HARLEY HAMMOCK TOURING SEATS (DELUXE MODEL SHOWN WITH OPTIONAL RIDER BACKREST)

Notice: The prices appearing in this catalog are the manufacturer's suggested retail prices. Actual retail prices may vary.

SOFTAIL

118 CRUISER

Cruiser – Seating

SUNDOWNER™ SOLO SEATS

Ride sun-up to sun-down in comfort and style. The Sundowner™ Solo Seat's shape and foam density were developed and refined during hundreds of hours of test rides and ergonomic evaluations. The unique seat features a deep bucket design that cradles the tailbone and provides back support for the rider. The narrow nose of the seat was sculpted to bring the legs closer together, and to look great where it meets the tail of the fuel tank. The seats are constructed with premium vinyl surfaces for comfort and durability.

A. SUNDOWNER SOLO SEAT – DELUXE AND HERITAGE SOFTAIL®

Styled with rounded curves and stitched center panels, this wide Sundowner Solo Seat complements the styling of classic Softail® models. Matching Passenger Pillion P/N 52400168 is available for Softail Deluxe and Heritage models.

52000291 **\$266.95**
Fits '18-later FLDE, FLHC and FLHCS models. Seat width 16.5".

B. SUNDOWNER SOLO SEAT – FAT BOY®

Smooth vinyl and double row stitched side panels define the look of the Sundowner Solo Seat for Fat Boy® models, and perfectly complement the Original Equipment passenger pillion. Or for additional passenger comfort, team this seat with the matching Sundowner Pillion P/N 52400170.

52000293 **\$266.95**
Fits '18-later FLFB and FLFBS models. Seat width 16.25".

C. BADLANDER® SEAT

Clean smooth covers, subtle top-stitching and a frame-hugging profile add up to a statement only Harley could create. The low design delivers a reduced seat height that is ideal for riders that want the shortest possible reach to the ground, and the long and lean shape allows tall riders to move back from the hand and foot controls without sitting higher on the bike. This seat is wrapped in water-resistant vinyl and finished with an embroidered Harley-Davidson script. Kit includes grab strap and all mounting hardware.

52000300 **\$319.95**
Fits '18-later FLDE, FLHC, FLHCS, FLSL, FXBB, FXBBS and FXST models. FLDE, FLSL, and FXBB models require separate purchase of Passenger Footpegs and Passenger Footpeg Mounting Kit P/N 50500769 or 50500771. Seat width 12.0"; passenger pillion width 5.5".

52000298 **\$319.95**
Fits '18-later FLSE, FXLR, FXLRS, FXLRST and FXRST models. Seat width 11.0"; passenger pillion width 6.0".



A. SUNDOWNER SOLO SEAT – DELUXE AND HERITAGE SOFTAIL® (DELUXE SHOWN WITH SUNDOWNER PILLION)



B. SUNDOWNER SOLO SEAT – FAT BOY® (SHOWN WITH SUNDOWNER PILLION)



C. BADLANDER SEAT (52000300 SHOWN)



D. SUNDOWNER SEAT – FXDR 114 STYLING



E. SUNDOWNER PASSENGER PILLION – FXDR 114 STYLING



F. SUNDOWNER SEAT – DELUXE, HERITAGE SOFTAIL®, SOFTAIL SLIM® & STREET BOB®



G. SUNDOWNER SEAT – FAT BOB®



H. SUNDOWNER SEAT – LOW RIDER®

CRUISER 119

Seating – Sundowner™

D. SUNDOWNER™ SOLO SEAT – FXDR® 114 STYLING

With the Sundowner™ Seat, you don't have to sacrifice style for comfort. The watch-strap pleated design provides a high-tech look while ensuring pressure points are eliminated and the black on black stitching complements the FXDR® 114 model's styling. While the Sundowner Seat's low profile makes it the perfect match for the FXDR 114, it is much wider than the stock seat, which helps distribute body weight for long-haul comfort while the scooped shape provides added rider back support while removing pressure points.

52000399 **\$266.95**
Fits '19-'20 FXDRS models. Seat width 14.0".

E. SUNDOWNER PASSENGER PILLION – FXDR 114 STYLING

Styled to match the design and stitching of the Sundowner Solo Seat with FXDR 114 styling, this Sundowner Passenger Pillion provides long-distance comfort for your riding companion.

52400204 **\$191.95**
Fits '19-'20 FXDRS models equipped with Sundowner Solo Seat P/N 52000399. Requires separate purchase of Passenger Footpeg Mounting Kit. Also fits with but does not match Original Equipment seat. Passenger pillion width 10.0".

SUNDOWNER TWO-UP SEATS

The Sundowner Seat provides the maximum in long-riding comfort. The deep-bucket design puts your body in the proper touring position and the generous padding makes it comfortable for both the rider and passenger as the miles are adding up. The dish shape provides added rider back support and the wide passenger pillion is shaped to minimize pressure points.

F. SUNDOWNER SEAT – DELUXE, HERITAGE SOFTAIL®, SOFTAIL SLIM® & STREET BOB®

Styled with smooth vinyl covering and generous rider and passenger spaces, this comfortable Sundowner Two-Up Seat is shaped to maximize time in the saddle. But the sweeping center panel stitching and the tapered sides visually shrink the seat to minimize the perceived bulk on a stripped-down Street Bob® or Softail Slim® model.

52000295 **\$372.95**
Fits '18-later FLDE, FLHC, FLHCS, FLSL, FXBB, FXBBS and FXST models. Seat width 14.25"; passenger pillion width 10.0".

G. SUNDOWNER SEAT – FAT BOB®

Inspired by the styling of the Original Equipment Fat Bob seat, this Sundowner Two-Up Seat provides long range comfort for both the rider and the passenger, without distracting from the bike's muscular personality.

52000349 **\$372.95**
Fits '18-later FXFB and FXFBS models. Seat width 14.0"; passenger pillion width 10.25".

H. SUNDOWNER SEAT – LOW RIDER®

Stitched to match the Original Equipment Low Rider® Seat, this comfortable Sundowner Two-Up Seat is ready to deliver you and your passenger to distant destinations in maximum comfort and style.

52000350 **\$372.95**
Fits '18-later FLSE, FXLR, FXLRS, FXLRST and FXRST models. Seat width 15.0"; passenger pillion width 12.25".

Notice: The prices appearing in this catalog are the manufacturer's suggested retail prices. Actual retail prices may vary.

Notice: The prices appearing in this catalog are the manufacturer's suggested retail prices. Actual retail prices may vary.

SOFTAIL

120 CRUISER

Seating & Pillion

A. PASSENGER PILLION – STREET BOB®/SOFTAIL SLIM® MODELS STYLING*

Bring a passenger along for the ride. This easy-to-install detachable Passenger Pillion features a tuck and roll cover styled to match the Original Equipment solo seat. Kit includes mounting hardware and grab strap.

52400128 Street Bob Styling. **\$185.95**
Fits '18-later FXBB, FXBBS and FXST models with Original Equipment solo seat. Requires separate purchase of Passenger Footpegs and Passenger Footpeg Mounting Kit P/N 50500769 or 50500771. Pillion width 6.75".

52400129 Softail Slim® Styling. **\$185.95**
Fits '18-'21 FLSL models with Original Equipment solo seat or Reach® Solo Seat P/N 52000303. Requires separate purchase of Passenger Footpegs and Passenger Footpeg Mounting Kit P/N 50500769 or 50500771. Pillion width 6.75".



A. PASSENGER PILLION – SOFTAIL STREET BOB STYLING



A. PASSENGER PILLION – SOFTAIL SLIM STYLING

B. SUNDOWNER PASSENGER PILLION – HERITAGE SOFTAIL STYLING*

Styled with double row center panel stitching and blacked-out rectangular studs, this comfortable Sundowner™ Passenger Pillion is a perfect replacement for the minimalistic Original Equipment passenger seat.

52400171 **\$201.95**
Fits '18-later FLHC and FLHCS models with Original Equipment Solo Seat. Passenger pillion width 11.25".



B. SUNDOWNER PASSENGER PILLION – HERITAGE SOFTAIL STYLING



C. SUNDOWNER PASSENGER PILLION – DELUXE & HERITAGE SOFTAIL

C. SUNDOWNER PASSENGER PILLION – DELUXE & HERITAGE SOFTAIL**

Turn your Sundowner Solo Seat equipped ride into the ultimate two-up touring machine. Styled to match the Sundowner Solo Seat P/N 52000291, this seat will keep your passenger happy for hours in the saddle.

52400168 **\$191.95**
Fits '18-later FLDE, FLHC and FLHCS models with Sundowner Solo Seat P/N 52000291. Passenger pillion width 11.25".

D. SUNDOWNER PASSENGER PILLION – BREAKOUT**

Shaped for maximum passenger comfort, this Sundowner Passenger Pillion is the perfect match for your Breakout® model's Original Equipment or Sundowner Solo Seat.

Fits '18-later FXBR and FXBRS models with Original Equipment solo seat, Sundowner Solo Seat P/N 52000429 or 52000292, or Reach Solo Seat P/N 52000304 or 52000430. Passenger pillion width 11.75".

52400169 Red Stitch. **\$201.95**
52400225 Grey Stitch. **\$201.95**



D. SUNDOWNER PASSENGER PILLION – BREAKOUT, RED STITCHING



D. SUNDOWNER PASSENGER PILLION – BREAKOUT, GREY STITCHING

F. PASSENGER PILLION – FXDR™ 114 STYLING

This pillion is a perfect match with the stock rider seat.

52400186 **\$225.95**
Fits '19-'20 FXDRS models equipped with Original Equipment solo seat. Requires separate purchase of Passenger Footpeg Kit P/N 50501128. Seat width 10.25".



E. SUNDOWNER PASSENGER PILLION – FAT BOY



F. PASSENGER PILLION – FXDR 114 STYLING

CRUISER 121

Seating Accessories

G. ROAD ZEPPELIN® SEAT PAD

Experience ultimate comfort. Designed to ensure hours of comfort in the saddle, Road Zeppelin® Seat Pads are equipped with a unique air bladder system that allows your weight to be supported evenly across the entire seating surface. Whether you have a low-profile seat or a larger, more comfortable seat, you will feel the benefits. This air bladder system is designed to reduce pressure points, provide shock absorption and reduce vibration. Unlike other mouth-inflated seat pads, the Road Zeppelin Pad features an easy-to-reach integrated hand pump and metered air release valve that permits quick and controllable adjustment. You can easily adjust the comfort and support while seated on the pad. The UV-stable and snag-resistant mesh cover allows air to circulate beneath the rider's body, reducing the temperature trapped between the rider and seat. Shaped to conform to most Harley-Davidson® seats, the pads feature adjustable mounting straps and a non-skid surface to keep them in place. The hand-washable seat pad can be deflated and rolled for compact storage.

52000327 Rider. **\$180.95**
Fits rider position on all models equipped with Original Equipment or accessory seats. Also fits passenger position on Touring models with large pillion area. Pad width – 14.0".

52400162 Passenger. **\$168.95**
Fits Original Equipment and accessory passenger pillions. Pad length – 12.0"; width – 9.0".



G. ROAD ZEPPELIN SEAT PAD

H. CIRCULATOR SEAT AND BACKREST PADS

Keep comfortable on your next long ride. These breathable Circulator Pads feature 3D construction that promotes air movement and reduces heat buildup where the rider's body touches the seat or backrest. Designed to keep the rider cool by reducing the perspiration buildup between you and the seating surface, the Circulator Pad can be installed and removed in seconds for easy cleaning. The low-profile design minimizes seat-height change compared to inflatable pads, while enhancing comfort with its shock-absorbing construction. Manufactured of UV-stable materials, these seat pads resist fading when exposed to the sun. Elastic under-seat strap and non-slip base provide secure installation and the available Circulator Passenger Pillion Pad attaches to the rider pad with hook-and-loop tabs.

51076-10 Large Seat Pad. **\$107.95**
Fits Softail®, Touring and Trike models with Original Equipment and accessory seats. Will not fit Bobber or Road Zeppelin seats. Pad width – 16.0".

51078-10 Passenger Pillion Pad. **\$74.95**
Fits Original Equipment and accessory passenger pillions. Pad width – 13.0".

52300103 Wide Backrest Pad. **\$64.95**
Fits wide profile rider and passenger backrest pads up to 12.0" wide and 9.0" tall.



H. CIRCULATOR SEAT AND WIDE BACKREST PADS

I. RAIN COVERS*

Featuring a handy storage sack, this black nylon, water-resistant, Cordura® cover packs easily and shelters your seat from the storm.

51638-97 Solo Seat. **\$33.95**
Fits H-D® solo seats (except XR and FLSTS).

51639-97 Two-Up. **\$35.95**
Fits VRSC™, XG, XL, Dyna® and Softail models with Two-Up seats. Does not fit Touring and Trike models. Does not fit with Rider Backrests.



I. RAIN COVER – SOLO SEAT



I. RAIN COVER – TWO-UP



***WARNING:** Do not install on models that are not equipped with passenger footpegs. Doing so could result in death or serious injury.



***WARNING:** Do not use while riding; could result in death or serious injury.

Notice: The prices appearing in this catalog are the manufacturer's suggested retail prices. Actual retail prices may vary.

Notice: The prices appearing in this catalog are the manufacturer's suggested retail prices. Actual retail prices may vary.

122 CRUISER

Seating – Accessories

A. TUCK & ROLL SOLO SADDLE

This Solo Saddle features a classic tuck & roll vinyl seating surface that is wrapped around a poured and contoured pad that maximizes comfort while maintaining the minimalist “just enough to ride” look. Easy to install, the combination of the bolt-on seat and the model-specific Spring Seat Installation Kit (sold separately) includes everything you need to get the bobber look. The Installation Kit includes beehive-style springs that help cushion the ride, or for maximum old school style, add the low profile Rigid Mount Kit for a truly slammed look.

52000315 **\$319.95**
Fits '18-later FL5L, FXBB, FXBBS and FXST models. Installation requires purchase of Spring Saddle Mounting Kit P/N 52100029. Does not fit with passenger pillion.



A. TUCK & ROLL SOLO SADDLE



B. BOBBER SOLO SADDLE – ANTIQUE BROWN LEATHER

B. BOBBER SOLO SADDLES

The smooth gloss black metal seat pan provides a clean, custom look. Easy to install, the combination of the bolt-on seat and the model-specific Spring Seat Installation Kit (sold separately) includes everything you need to get the bobber look. The Installation Kit includes beehive-style springs that help cushion the ride, or for maximum old-school style, add the low profile Rigid Mount Kit for a truly slammed look.

52000381 Antique Brown Leather. **\$319.95**
Fits '18-later FL5L, FXBB, FXBBS and FXST models. Installation requires purchase of Spring Seat Mounting Kit P/N 52100029. Does not fit with passenger pillion.



C. SPRING SADDLE INSTALLATION KIT



D. RIGID MOUNT SADDLE INSTALLATION KIT

C. SPRING SADDLE INSTALLATION KIT

Required when fitting a Spring Solo Saddle on '18-later Street Bob® and Softail Slim® models, this kit includes everything needed for a simple bolt-on installation. The kit features beehive-style springs that maximize seat travel while maintaining a low-profile, a custom formed steel under-seat cover, a polished stainless steel hinge and all necessary hardware. The under-seat cover is finished in gloss black, and features a stainless steel mesh accent panel. The seat can be tilted forward, permitting removal of the under-seat panel and easy access to suspension adjustment.

52100029 **\$258.95**
Fits '18-later FL5L, FXBB, FXBBS, FXLRS, FXLRST and FXST models.

D. RIGID MOUNT SADDLE INSTALLATION KIT

Get the low, lean, minimalistic, garage-built look when you want it. When you need a little more cushion, these posts can easily be replaced with the original springs. Kit includes two gloss black aluminum threaded posts and grommets.

52100043 **\$54.95**
Fits '18-later FL5L, FXBB, FXBBS and FXST models. Requires separate purchase of Spring Saddle Installation Kit P/N 52100029.



E. QUICK-RELEASE SEAT HARDWARE KIT – CHROME



E. QUICK-RELEASE SEAT HARDWARE KIT – GLOSS BLACK

E. QUICK-RELEASE SEAT HARDWARE KIT

A raised-logo Harley-Davidson emblem finishes the look. SAE 1/4"-20 thread.

Fits '97-later XG, XL, Dyna®, Softail® (except '12-'17 FLS models equipped with Original Equipment seat), Touring and Trike models equipped with SAE 1/4"-20 seat mount hardware. Does not fit seats equipped with spring-loaded rear seat bracket.

51676-97A Chrome. **\$23.95**
10500093 Gloss Black. **\$23.95**

F. SEAT MOUNTING NUTS – GLOSS BLACK

No tools required. Sold in pairs.

10400049 **\$28.95**
Fits all Softail and Touring models with Original Equipment or Genuine Motor Accessory 2-piece seat and knurled seat mounting nuts.



F. SEAT MOUNTING NUTS – GLOSS BLACK



G. TANK KNEE PAD KIT

G. TANK KNEE PAD KIT

These self-adhesive rubber knee pads provide a touch of old-school style. The rich black rubber pads feature tapered ribs and a raised Bar & Shield logo to protect the surfaces where your legs contact the tank. The compact pads measure 7.0" by 2.75", and are flexible enough to fit many tank profiles. Sold in matched pairs.

57300065 **\$43.95**
Fits fuel tanks on many Harley-Davidson Street®, Sportster®, Dyna and Softail models. May cover a portion of fuel tank graphics; check appearance before adhering to tank.

CRUISER 123

THE FLEXIBILITY OF SUPPORT

A HoldFast™ detachable sissy bar and passenger backrest pad is the starting point to build a complete touring machine.

The backrest provides long-range comfort and support while adding a feeling of control and confidence for the passenger. Once the Docking Hardware Kit is installed, adding or removing a HoldFast detachable accessory is a simple “pivot and click” proposition.

DETACHING A HOLDFAST™ ACCESSORY



INSTALL

Position the sissy bar to pivot on the front docking points. Rotate the backrest to engage the rear docking points, and lock it into place with a gentle downward push. That's all there is to do.



REMOVE

Grasp and pull the latching tabs rearward to release the sissy bar and pivot forward to clear the rear docking points. Lift the upright free from the front docking points, and you're done.



A. HOLDFAST™ DOCKING HARDWARE KIT

The ideal choice for maximum versatility, this complete kit contains the docking hardware necessary to install all HoldFast™ detachable accessory options. Even if you only install a passenger backrest today, this kit allows you to add additional accessories as your touring demands change. Kit includes docking points to allow installation of H-D® Detachables™ Sissy Bar, Solo Luggage Rack, Two-Up Luggage Rack, Solo Tour-Pak® Rack or Two-Up Tour-Pak Rack.

Fits '18-later FL5B, FL5BS, FXBR and FXBRS models.

52300643 Chrome. **\$54.95**
52300644 Gloss Black. **\$54.95**

Fits '18-later FL5E, FL5C, FL5CS, FL5L, FXBB, FXBBS, FXFB, FXFBS, FL5B, FXLR, FXLRS, FXLRST, FXRST and FXST models.

52300645 Chrome. **\$54.95**
52300646 Gloss Black. **\$54.95**

Notice: The prices appearing in this catalog are the manufacturer's suggested retail prices. Actual retail prices may vary.

124 CRUISER

Backrests & Racks

A. HOLDFAST™ SISSY BAR UPRIGHT

A sissy bar and passenger backrest pad is the starting point for building a complete touring machine. The backrest adds long-range comfort and support and provides a feeling of confidence and control for the passenger. HoldFast™ One-Piece Uprights feature an exclusive latch system that permits the backrest to be installed or removed in seconds to add versatility to your ride. The HoldFast sissy bar upright simply slips into position on the docking points, and the fingertip latches are clicked into position for a positive lock. HoldFast Sissy Bars are available in short and standard height for optimized passenger back support. A wide variety of Backrest Pads are available to match your comfort or customizing requirements, and the kit includes a matching 3-point backrest pad mount bracket.

Fits '18-later FLDE, FLHC, FLHCS, FLSL, FXBB, FXBBS and FXST models. Installation requires separate purchase of model-specific Docking Hardware Kit.

52300442	Standard-Height, Chrome.	\$221.95
52300446	Standard-Height, Gloss Black.	\$221.95
52300448	Short, Gloss Black.	\$221.95

Fits '18-later FLFB, FLFBS, FXBR and FXBRS models. Installation requires separate purchase of model-specific Docking Hardware Kit.

52300437	Standard-Height, Chrome.	\$221.95
52300439	Standard-Height, Gloss Black.	\$221.95
52300441	Short, Gloss Black.	\$221.95

Fits '18-later FXFB and FXFBS models. Installation requires separate purchase of model-specific Docking Hardware Kit.

52300454	Standard-Height, Gloss Black.	\$221.95
52300456	Short, Gloss Black.	\$221.95

Fits '18-later FLSB, FXLR, FXLRS, FXLRST and FXRST models. Installation requires separate purchase of model-specific Docking Hardware Kit.

52300432	Standard-Height, Chrome.	\$221.95
52300434	Standard-Height, Gloss Black.	\$221.95
52300435	Short, Gloss Black.	\$221.95



A. HOLDFAST SISSY BAR UPRIGHT – CHROME



A. HOLDFAST SISSY BAR UPRIGHT – GLOSS BLACK



A. STANDARD-HEIGHT HOLDFAST SISSY BAR UPRIGHT – GLOSS BLACK (HERITAGE SOFTAIL MODEL SHOWN)



A. STANDARD-HEIGHT HOLDFAST SISSY BAR UPRIGHT – CHROME (LOW RIDER MODEL SHOWN)



A. SHORT HOLDFAST SISSY BAR UPRIGHT – GLOSS BLACK (LOW RIDER MODEL SHOWN)



B. ONE-PIECE TALL RIGID MOUNT SISSY BAR (SHOWN WITH PASSENGER BACKREST PAD 52300504)



B. ONE-PIECE TALL RIGID MOUNT SISSY BAR



B. ONE-PIECE TALL RIGID MOUNT SISSY BAR



C. PASSENGER BACKREST PAD – 21" TALL SISSY BAR

CRUISER 125

Backrests & Racks

B. ONE-PIECE TALL RIGID MOUNT SISSY BAR

Strap on your bed roll or your backpack, and hit the road. This classic paper-clip style sissy bar is the perfect finishing touch to a stripped-down bobber motorcycle build. The 21" tall sissy bar features a rolled steel upright that is welded to the rigid-mount side plates for a custom-made look. Bolted directly to the fender struts, the upright offers a narrow profile and a clean installation. Designed to complement two-up and solo-seat equipped motorcycles, this sissy bar kit includes installation hardware for Passenger Backrest Pad P/N 52300504 (pad sold separately). Available in your choice of gloss black or chrome finish, kit includes installation hardware.

Fits '18-later FLDE, FLHC, FLHCS, FLSL, FXBB, FXBBS and FXST models. Does not fit with Boom!™ Audio Cruiser Amp & Speaker Expansion Kit P/N 76000666 or 76000700.

52300503	Chrome.	\$232.95
52300502	Gloss Black.	\$232.95

C. PASSENGER BACKREST PAD – 21" TALL SISSY BAR

Add a comfortable back stop for your passenger. This easy-to-install minimalistic pad utilizes the mounting strap included with the Tall Sissy Bar for a clean, tidy look. The smooth vinyl covered pad is styled to complement a wide variety of stock and accessory seats.

52300504 **\$74.95**

Fits '18-later FLDE, FLHC, FLHCS, FLSL, FXBB, FXBBS and FXST models equipped with Rigid Mount Tall Sissy Bar Upright P/N 52300502 or 52300503.

Notice: The prices appearing in this catalog are the manufacturer's suggested retail prices. Actual retail prices may vary.

Notice: The prices appearing in this catalog are the manufacturer's suggested retail prices. Actual retail prices may vary.

126 CRUISER

Backrests & Racks

A. PASSENGER BACKREST PAD – COMPACT

Sized to complement low-profile custom seats, this Compact Passenger Backrest Pad combines practical passenger support with custom compact style. Pads include mounting bracket and hardware required for attachment to sissy bar upright. Pad height 3.75"; width 6.5".

Fits '18-later Softail® and '22-later Nightster® models equipped with Short or Standard Height HoldFast™ Sissy Bar Uprights. Also fits Touring models equipped with Short H-D® Detachables™ Passenger Sissy Bar Upright P/N 52935-04A, 52610-09A or 54248-09A. Will not fit seats with tall passenger pillion pads.

52300559A	Smooth Black Vinyl.	\$69.95
52300558A	Fat Bob Styling.	\$79.95
52300555A	Red Stitch Breakout Styling.	\$79.95
52300617A	Grey Stitch Breakout Styling.	\$79.95
52300556A	Fat Boy Styling.	\$79.95

B. PASSENGER BACKREST PAD – MID-SIZED

Sized to fit both Low and Standard-Height HoldFast Sissy Bar Uprights, these Mid-Sized Backrest Pads feature a gentle curved shape that cradles the spine and provides hours of passenger comfort. Pad height 7.0"; width 6.75".

Fits '18-later Softail models equipped with Standard Height HoldFast Sissy Bar Uprights. Also fits Touring models equipped with Standard-Height H-D Detachables Passenger Sissy Bar Uprights P/N 52300324, 52627-09A, 54247-09A, 52933-97C or 52805-97B, Tall H-D Detachables Passenger Sissy Bar Upright P/N 52723-06A, Premium H-D Detachables Sissy Bar Upright 52300257 or 52300258.

52300560	Smooth Black Vinyl.	\$79.95
52300557	Low Rider Styling.	\$90.95

C. STYLED BACKREST PAD MOUNT

This custom Backrest Mounting Plate replaces the stamped metal mount for a distinctive look. The mirror-finished bracket, chrome-plated mounting hardware and Vivid Black insert contrasts with a leather or vinyl backrest pad to dress your Touring bike in style.

52825-05 **\$54.95**

Fits Touring models equipped with H-D Detachables Sissy Bar Upright P/N 52805-97B, 52935-04A, 52933-97C, 52723-06A, 52610-09A, 52627-09A, 52300257 or 52300258. Also fits '18-later Softail models equipped with HoldFast Sissy Bar Uprights (except if equipped with Compact Size Pad).



A. PASSENGER BACKREST PAD – SMOOTH BLACK VINYL



A. PASSENGER BACKREST PAD – FAT BOB STYLING



A. PASSENGER BACKREST PAD – '18 BREAKOUT STYLING, RED STITCH



A. PASSENGER BACKREST PAD – '19-'20 BREAKOUT STYLING, GREY STITCH



A. PASSENGER BACKREST PAD – FAT BOY STYLING



B. PASSENGER BACKREST PAD – MID-SIZED SMOOTH BLACK VINYL



B. PASSENGER BACKREST PAD – MID-SIZED LOW RIDER STYLING

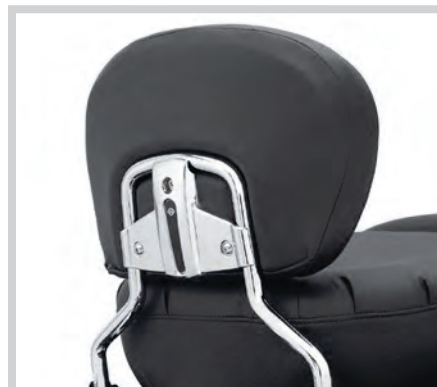

C. STYLED BACKREST PAD MOUNT



D. SPORT LUGGAGE RACK FOR HOLDFAST Sissy BAR UPRIGHTS – CHROME (LOW RIDER MODEL SHOWN)



D. SPORT LUGGAGE RACK FOR HOLDFAST Sissy BAR UPRIGHTS – GLOSS BLACK (LOW RIDER MODEL SHOWN)



E. HOLDFAST TWO-UP LUGGAGE RACK – CHROME (LOW RIDER MODEL SHOWN)



E. HOLDFAST TWO-UP LUGGAGE RACK – GLOSS BLACK (FAT BOB MODEL SHOWN)



F. HOLDFAST LOCKING LATCH – CHROME



F. HOLDFAST LOCKING LATCH – CHROME (TOUR-PAK RACK)

CRUISER 127

Backrests & Racks

D. SPORT LUGGAGE RACK FOR HOLDFAST™ Sissy BAR UPRIGHTS*

Smooth sweeping curves and the brilliant chrome or gloss black finish defines the look of this Sport Luggage Rack. Designed to complement both short and standard-height HoldFast™ Sissy Bar Uprights, this sleek rack adds a practical and stylish touch to the motorcycle. When firmly bolted to the HoldFast Sissy Bar system, the combined backrest and luggage rack can be installed or removed from the bike in seconds for a truly versatile touring or cruising machine. For convenient packing, the side supports of these round bar racks are slotted to accept nylon luggage tie-down straps.

Fits '18-later FLDE, FLHC, FLHCS, FLSL, FXBB, FXBBS and FXST models equipped with HoldFast Sissy Bar Upright.

50300124A	Chrome.	\$201.95
50300125A	Gloss Black.	\$191.95

Fits '18-later FLFB, FLFBS, FXBR and FXBRS models equipped with HoldFast Sissy Bar Upright.

50300126A	Chrome.	\$201.95
50300127A	Gloss Black.	\$191.95

Fits '18-later FLFB, FXFB, FXFBS, FXLR, FXLRS and FXLRST models equipped with HoldFast Sissy Bar Upright.

50300130A	Chrome.	\$201.95
50300131A	Gloss Black.	\$191.95

E. HOLDFAST™ TWO-UP LUGGAGE RACK*

Low-profile styling defines the look of this Two-Up Luggage Rack. Designed to be installed without a sissy bar, this rack is ideal for carrying everything you need on your daily commute. These HoldFast™ Luggage Racks feature an exclusive latch system that permits the rack to be installed or removed in seconds, adding versatility to your ride. The HoldFast rack simply slips into position on the docking points, and the fingertip latches are clicked into position for a positive lock. Available in mirror chrome or rich gloss black finish, the leading edge of the rack features a flip design that keeps luggage from sliding forward, and provides a convenient tie-down attachment point.

Fits '18-later FLDE, FLHC, FLHCS, FLSL, FXBB, FXBBS and FXST models equipped with two-up seats. Installation requires separate purchase of model-specific Docking Hardware Kit. FLHC and FLHCS models with oversize international registration plates may interfere with Luggage Rack and may require separate purchase of License Plate Relocation Kit P/N 67900472.

50300133	Gloss Black.	\$237.95
-----------------	--------------	-----------------

Fits '18-later FLFB, FXLR, FXLRS, FXLRST and FXRST models equipped with two-up seats. Installation requires separate purchase of model-specific Docking Hardware Kit.

50300136	Chrome.	\$237.95
-----------------	---------	-----------------

Fits '18-later FXFB and FXFBS models equipped with two-up seats. Installation requires separate purchase of model-specific Docking Hardware Kit.

50300140	Gloss Black.	\$237.95
-----------------	--------------	-----------------

F. HOLDFAST™ LOCKING LATCH

Secure your valuables. This locking system allows you to protect your HoldFast™ Sissy Bar, Luggage Rack or Tour-Pak® Mounting Rack from theft, providing security and peace of mind when parking your vehicle. The kit includes (2) keys and (1) locking mechanism.

Fits '18-later Softail® models equipped with HoldFast detachable Sissy Bar, Luggage Rack or Solo Tour-Pak Mounting Rack.

52300513	Chrome.	\$59.95
52300514	Black.	\$59.95

Fits '18-later FLDE, FLHC, and FLHCS models equipped with HoldFast detachable Two-Up Tour-Pak Mounting Rack.

52300518	Chrome.	\$59.95
52300519	Black.	\$59.95

***WARNING:** Do not use this rack as a seat. Do not exceed the fender rack weight capacity. Using as seat or exceeding this capacity could cause handling problems, which could result in loss of control and death or serious injury.

Notice: The prices appearing in this catalog are the manufacturer's suggested retail prices. Actual retail prices may vary.

Notice: The prices appearing in this catalog are the manufacturer's suggested retail prices. Actual retail prices may vary.

128 CRUISER

Saddlebags

A. H-D® DETACHABLES™ SADDLEBAGS

Sized for commute to work or a ride across the country, these modern bags are styled to complement the stripped down look of the Softail® cruiser models. These modern waterfall-style saddlebags are completely removable with the simple pull of the internal handle and a rearward slide, leaving your bike stripped down and unencumbered. When removed, the bag leaves behind simple, inconspicuous docking points. The bags feature a flip back lid and a reinforced vinyl-wrapped body with perforated style panels that complement stock and many accessory seats. The bags are finished with nickel snap-to-close hardware and a black chrome Harley-Davidson® signature medallion. Bags include all required mounting hardware, and can be installed with HoldFast™ sissy bars and racks when equipped with model-specific docking hardware. Luggage capacity: 2,170 cubic inches total

90201561A **\$903.95**
Fits '18-later FLSTL, FXBB, FXBBS, FXLR, FXLRS and FXST models. Does not fit FXST and FLSTL models in Europe, India, or Japan. Installation requires separate purchase of License Plate/Turn Signal Relocation Kit P/N 67800802A or 67800830A.

B. H-D DETACHABLES LEATHER SADDLEBAGS – NOSTALGIC STYLE

These traditional throw-over style leather saddlebags are completely removable with the simple pull of the internal handle, leaving your bike clean and ready to cruise the boulevard. When removed, the bag leaves behind simple, inconspicuous docking points. Styled to complement the unique look of the stripped-down Softail Slim® and Street Bob® models, these bags feature a leather tub and a reinforced lid that complement stock and many accessory seats. The traditional leather straps and the brass buckles and hardware add a distinctive retro look. Bags include all required mounting hardware, and can be installed with HoldFast sissy bars and racks when equipped with model-specific docking hardware. Luggage capacity: 2,170 cubic inches total.

90201552A **\$956.95**
Fits '18-later FLSTL, FXBB, FXBBS, FXLR, FXLRS and FXST models. Installation requires separate purchase of License Plate/Turn Signal Relocation Kit P/N 67800802A or 67800830A..

Shown with: REAR TURN SIGNAL/LICENSE PLATE RELOCATION KIT

Required for saddlebag installation on certain Softail models, these elegant sweeping mounts move the turn signals and the side-mount rearward on the fender struts, maintaining the stock lines. Available in chrome or gloss black to match the Original Equipment fender strut covers.

Fits '18-later FLFB, FLFBS, FLSTL, FXBB, FXBBS, FXFB, FXFBS, FXBR, FXBRS, FXLR, FXLRS and FXST models.

67800802A Chrome. **\$107.95**
67800830A Black. **\$107.95**

NOTE: Some Harley-Davidson® saddlebags are made of leather. Fine leathers or other natural materials WILL gain "character," such as wrinkles or wear, with age. This is normal. A fine, aged patina and character wrinkles are a sign of the extremely high-quality materials used to construct your saddlebags. The appearance of scars or marks on the leather is a result of using natural leather panels and should not be thought of as an imperfection. Please use Harley-Davidson® Leather Protectant P/N 93600034 to protect your investment.



A. H-D DETACHABLES SADDLEBAGS



C. H-D DETACHABLES LOCKING SADDLEBAGS – BREAKOUT SHOWN



B. H-D DETACHABLES LEATHER SADDLEBAGS – NOSTALGIC STYLE



D. RIGID MOUNT SADDLEBAGS – SOFTAIL DELUXE STYLING

CRUISER 129

Saddlebags

C. H-D® DETACHABLES™ LOCKING SADDLEBAGS

Shaped to complement the flowing lines of the Softail® cruiser models, these premium saddlebags feature a classic slant-style design with a modern twist. Wrapped in a combination of smooth and perforated-look vinyl, the hardshell bags will retain their shape in all kinds of weather. The hinged locking lid tilts outward for easy one-handed access. And when your trip is over, the bags can be removed with the simple turn of the internal lever, leaving behind nothing but inconspicuous docking points. Bags include all required mounting hardware, and can be installed with HoldFast™ sissy bars and racks when equipped with model-specific docking hardware.

90201555A **\$956.95**
Fits '18-'20 FLDE models. Luggage capacity: 2,970 cubic inches total.

90201513A **\$956.95**
Fits '18-later FLFB, FLFBS, FXBR and FXBRS models. Installation requires separate purchase of License Plate/Turn Signal Relocation Kit P/N 67800802 or 67800830. Luggage capacity: 2,840 cubic inches total.

D. RIGID MOUNT SADDLEBAGS – SOFTAIL DELUXE STYLING

These premium saddlebags are ready to go the distance. Styled to complement the Softail® Deluxe model's profile, these bags offer plenty of storage for a trip across town or across the country. The fine textured vinyl surface and black chrome medallion add an elegant touch, and the hard-shell body retains its shape in all kinds of weather. The push-button latching lids swing open with one hand for easy loading, and are lockable for added security. The bags are compatible with HoldFast accessories when installed with the appropriate docking hardware kits. Kit includes reflectors. Total luggage capacity: 2,510 cubic inches.

90201558 **\$893.95**
Fits '18-'20 FLDE models.

NOTE: Some Harley-Davidson® saddlebags are made of leather. Fine leathers or other natural materials WILL gain "character," such as wrinkles or wear, with age. This is normal. A fine, aged patina and character wrinkles are a sign of the extremely high-quality materials used to construct your saddlebags. The appearance of scars or marks on the leather is a result of using natural leather panels and should not be thought of as an imperfection. Please use Harley-Davidson® Leather Protectant P/N 93600034 to protect your investment.

Notice: The prices appearing in this catalog are the manufacturer's suggested retail prices. Actual retail prices may vary.

130 CRUISER

Saddlebags

A. OVERWATCH QUICK-RELEASE SADDLEBAGS

These saddlebags feature a classic T-Sport profile with modern features. The new two-point mounting system makes it fast and easy to remove and install these bags, with a clean look when the bags are not installed. Features a rugged ballistic nylon shell with leather lid and an internal sag-prevention design to maintain original shape. The durable materials offer UV fade resistance.

The internal limiter strap prevents contents from spilling when opened. Keep necessities accessible with an external zipper pocket for quick access to small items. Waterproof dry bags included. An internal locking mechanism secures the bags to bike and prevents unwanted removal from the vehicle. Compatible with existing HoldFast™ racks, backrests, and other components

Luggage Capacity:
Collapsed Volume -
Left bag - 1,118.74 in³
Right Bag - 1,260.00 in³
Expanded Volume -
Left bag - 1,478.74 in³
Right Bag - 1,610.00 in³

90202332 \$774.95
Fits '18-later FL5B, FL5L, FX5B, FX5S, FXLR, FXLRS, FXLRST and FXST models. All models (except FL5B and FXLRST) require appropriate turn signal relocation kit. Domestic FL5L, FX5B and FX5S require additional parts to move tail light, see instruction sheet. FX5B, FX5S, FL5L and FXST DOM and CAL models require the license plate to be relocated. See instruction sheet for parts list and assembly instructions.

B. H-D DETACHABLES SADDLEBAGS – BRASS TRIM

Trimmed with classic valise straps, brass buckles and a matching brass Harley-Davidson® signature medallion, these bags are the perfect complement to your custom ride. These large-capacity lockable detachable saddlebags are completely removable with the simple pull of the internal handle, leaving your bike clean and ready to cruise the boulevard. When removed, the bags leave behind two simple, inconspicuous docking points. These handsome slant-style bags feature push-button latching swing-out lids that are easy to operate with one hand. The hard-shell design retains its shape in all kinds of weather, and the locking hinged lids offer modern convenience and security. Bags include all required mounting hardware, and can be installed with HoldFast sissy bars and racks when equipped with model-specific docking hardware.

90201645A \$1,011.95
Fits '18-later FL6B, FL6S, FX6B and FX6S models. Installation requires separate purchase of License Plate/Turn Signal Relocation Kit P/N 67800802A or 67800830A. Luggage capacity: 2,840 cubic inches total.

NOTE: Some Harley-Davidson® saddlebags are made of leather. Fine leathers or other natural materials WILL gain “character,” such as wrinkles or wear, with age. This is normal. A fine, aged patina and character wrinkles are a sign of the extremely high-quality materials used to construct your saddlebags. The appearance of scars or marks on the leather is a result of using natural leather panels and should not be thought of as an imperfection. Please use Harley-Davidson® Leather Protectant P/N 93600034 to protect your investment.

NOTE: Some Harley-Davidson® saddlebags are made of leather. Fine leathers or other natural materials WILL gain “character,” such as wrinkles or wear, with age. This is normal. A fine, aged patina and character wrinkles are a sign of the extremely high-quality materials used to construct your saddlebags. The appearance of scars or marks on the leather is a result of using natural leather panels and should not be thought of as an imperfection. Please use Harley-Davidson® Leather Protectant P/N 93600034 to protect your investment.

Notice: The prices appearing in this catalog are the manufacturer's suggested retail prices. Actual retail prices may vary.



A. OVERWATCH QUICK-RELEASE SADDLEBAGS



B. H-D DETACHABLES SADDLEBAGS – BRASS TRIM (BREAKOUT MODEL SHOWN)



C. FXLRST SADDLEBAGS – VIVID BLACK



D. SINGLE-SIDED SWINGARM BAG – ANTIQUE BROWN LEATHER



D. SINGLE-SIDED SWINGARM BAG – BLACK LEATHER

CRUISER 131

Saddlebags

C. FXLRST SADDLEBAGS - VIVID BLACK

Ready to road trip? These detachable rigid saddlebags are shaped to perfectly match the West Coast performance style and attitude of Harley-Davidson® Low Rider® and Low Rider® S models. The clam-shell design is easy to load and unload and can be opened with one hand by a seated rider. A damping device allows the saddlebag lids to open smoothly. The bags can be removed in seconds with an internal quick-release mechanism, leaving behind mounting points that are barely visible. The bags can also be locked to the bike from the inside and locked closed externally by keying the included lock set to match the vehicle key. Includes mounting hardware. Combined saddlebag capacity is 1.9 cubic feet (50L).

90202534DH \$1,499.95
Fits '18-later FL5B, FXLR and FXLRS models. FXLR and FXLRS require separate purchase of Turn Signal Relocation Kit P/N 67801349.

D. SINGLE-SIDED SWINGARM BAG

Less is more. With enough room for the essentials, these stylish Swingarm Bags eliminate the need to stuff your pockets or bungee a bag across the passenger pillion. Shaped to hug the contour of your bike's frame, these compact bags add an old-school look. Bags are constructed of heavyweight leather and feature a pouch-style flap lid that is secured with two traditional straps and buckles. The semi rigid-backed bag is secured to the left side of the bike with easy-to-install adjustable straps. Luggage capacity: 450 cubic inches total.

SINGLE-SIDED SWINGARM BAG – ANTIQUE BROWN LEATHER

Crafted from supple brown pull-up leather, this classic Swingarm Bag will gain character and a well-worn authentic look with use. The flip-open lid is secured with traditional straps and buckles, and the bag features antique hardware that complements the old-school look.

90201568 \$242.95
Fits '00-later Softail® models (except FLSTC, FLSTNSE, FLSTSE, FXDRS, FXCW, and FXWC). Does not fit models equipped with left-hand toolbox, passenger footboards, chrome swingarm covers, saddlebags, or saddlebag guards.

SINGLE-SIDED SWINGARM BAG – BLACK LEATHER

Constructed with heavy boot-grade leather, this rich black Swingarm Bag is the perfect complement to any paint color or customizing style. The flip-open lid is secured with quick-disconnect clips hidden behind the traditional leather straps and brushed nickel-finished buckles.

90201567 \$242.95
Fits '00-later Softail models (except FLSTC, FLSTNSE, FLSTSE, FXDRS, FXCW, and FXWC). Does not fit models equipped with left-hand toolbox, passenger footboards, chrome swingarm covers, saddlebags, or saddlebag guards.

NOTE: Some Harley-Davidson® saddlebags are made of leather. Fine leathers or other natural materials WILL gain “character,” such as wrinkles or wear, with age. This is normal. A fine, aged patina and character wrinkles are a sign of the extremely high-quality materials used to construct your saddlebags. The appearance of scars or marks on the leather is a result of using natural leather panels and should not be thought of as an imperfection. Please use Harley-Davidson® Leather Protectant P/N 93600034 to protect your investment.

Notice: The prices appearing in this catalog are the manufacturer's suggested retail prices. Actual retail prices may vary.

SOFTAIL

132 CRUISER

Saddlebags

A. BLACK STANDARD LINE THROW-OVER SADDLEBAGS

Made of ultra-durable leather-like synthetic featuring a debossed H-D #1 logo, the Black Standard Line Bags have a simple, black on black style that complements many styling directions and budgets. An internal reinforcement system maintains the bag's shape over time. The "MOLLE-style" system of mounting loops accommodate hook and loop straps and allow for versatility in mounting. The bags feature matte black enamel buckles with hidden quick-detach buckles underneath. These Throw-Over Bags feature side gussets for increased capacity and straight and perpendicular mounting loops for easy mounting. Quick-release buckles get you in and out of the bag fast. These Throw-Over Bags can be used with or without a passenger pillion. If used with a passenger pillion, the straps should be mounted under the pillion and the cross-over straps feature a soft, non-scratch backing. Installation requires purchase of Saddlebag Support Rails and may require the purchase of a Turn Signal Relocation Kit. Large bag measures: 16.5" L x 11.5" H x 7" D. Internal capacity: 1,350CI. Weight capacity: 10 lbs/bag. Compact bag measures: 10" L x 11.5" H x 5.25" D. Internal capacity: 600CI. Weight capacity: 6 lbs/bag.

Fits '82-'22 XL (except XL1200T), '08-'17 Dyna® (except FLD), '84-'99 Softail®, and '18-later Softail models equipped with H-D® Saddlebag Supports. '18-later Softail models require purchase of Turn Signal Relocation Kit P/N 67800802A or 68700830A.

90201770	Large.	\$295.95
90201769	Compact.	\$242.95

B. SADDLEBAG SUPPORTS – GLOSS BLACK

Required to keep your throw over-style saddlebags away from the wheel, swingarm and brake caliper. Fits with or without Sissybar Uprights.

90201777 **\$110.95**
Fits '18-later FLSL, FXBB, FXBBS and FXST models. Required with Throw-Over Saddlebags P/Ns 90201770 or 90201769.

C. SADDLEBAG TRAVEL-PAKS – HERITAGE MODEL

Simplify packing and unpacking your motorcycle. Made from water-resistant material, these liners are designed to fit into the Original Equipment saddlebags on Heritage Classic models and Softail® Deluxe Rigid Mount Saddlebags P/N 90201558. The Travel Pak bags feature two-way zippers for easy access, and embossed Bar & Shield patches for style.

93300107 **\$66.95**
Fits '18-later FLHC and FLHCS models with Original Equipment saddlebags. Also fits FLDE models equipped with Softail Deluxe Rigid Mount Saddlebags P/N 90201558.

D. SADDLEBAG TRAVEL-PAKS – SPORT GLIDE® MODEL

Simplify packing and unpacking your motorcycle. These well-constructed water-resistant bags are designed to fit perfectly into the Sport Glide® model's saddlebags. The soft sides conform to the interior of the luggage to help use every available inch of space. Styled with a Bar & Shield logo, these bags feature heavy-duty zippers, comfortable carrying handles and convenient D-rings for optional shoulder straps.

93300110 **\$71.95**
Fits '18-later FLSE and '22-later FXLRST models. Also fits '18-later FXLR and FXLRS models equipped with ST Saddlebags P/N 90202534.

E. SADDLEBAG GUARDS

Saddlebag guards provide a style borrowed from the past that makes a unique statement here and now. Includes mounting hardware and instructions.

Fits '18-later FLHC and FLHCS models.

90201312	Chrome.	\$276.95
90201315	Black.	\$276.95

NOTE: Some Harley-Davidson® saddlebags are made of leather. Fine leathers or other natural materials WILL gain "character," such as wrinkles or wear, with age. This is normal. A fine, aged patina and character wrinkles are a sign of the extremely high-quality materials used to construct your saddlebags. The appearance of scars or marks on the leather is a result of using natural leather panels and should not be thought of as an imperfection. Please use Harley-Davidson® Leather Protectant P/N 93600034 to protect your investment.



A. BLACK STANDARD LINE THROW-OVER SADDLEBAGS – LARGE



A. BLACK STANDARD LINE THROW-OVER SADDLEBAGS – COMPACT



B. SADDLEBAG SUPPORTS – GLOSS BLACK



C. SADDLEBAG TRAVEL-PAKS – HERITAGE MODEL



D. SADDLEBAG TRAVEL-PAKS – SPORT GLIDE MODEL



E. SADDLEBAG GUARDS – CHROME



E. SADDLEBAG GUARDS – BLACK



F. TOUR-PAK LUGGAGE – HERITAGE STYLE



G. TOUR-PAK LUGGAGE – SMOOTH VINYL



H. HOLDFAST SOLO TOUR-PAK LUGGAGE MOUNTING RACK – CHROME



H. HOLDFAST SOLO TOUR-PAK LUGGAGE MOUNTING RACK – GLOSS BLACK



I. HOLDFAST TWO-UP TOUR-PAK MOUNTING RACK – CHROME



I. HOLDFAST TWO-UP TOUR-PAK MOUNTING RACK – GLOSS BLACK (FLSB MODEL SHOWN)

CRUISER 133

Tour-Pak® Luggage

TOUR-PAK® LUGGAGE

When you're serious about racking up the miles, Tour-Pak® luggage systems allow you to pack everything you need for a cross-country trip or a run to the grocery store. Each style of Tour-Pak Luggage features a lockable lid and a matching backrest pad. And, when you arrive at your destination, the Tour-Pak and its HoldFast™ Mounting Rack can be removed in seconds to return your bike to a stripped-down profile. Each Tour-Pak has a capacity of 2,580 cubic inches (enough to fit one full-face helmet or two half helmets) and measures 18.5" W x 18.75" D x 12.25" H. Mounting racks and docking kits are sold separately.

Fits '18-later FLDE, FLHC, FLHCS, FLSE, FLSE, FXBB, FXBBS and FXST models equipped with HoldFast Detachable Solo or Two-Up Tour-Pak Mounting Rack.

F. TOUR-PAK LUGGAGE – HERITAGE STYLE

Accented with twin rows of blacked-out rectangular studs, this Tour-Pak is the perfect match for the seats and saddlebags on your Heritage Softail® model.

53000598	\$756.95
-----------------	-----------------

G. TOUR-PAK LUGGAGE – SMOOTH VINYL

Styled to complement a wide variety of Softail® seats and saddlebags and features fine-grain texturing with perforated side panels.

53000570	\$737.95
-----------------	-----------------

HOLDFAST™ DETACHABLE TOUR-PAK LUGGAGE MOUNTING RACK

Harley-Davidson HoldFast docking hardware allows you to transform your ride in the blink of an eye. Switch from a comfortable passenger backrest to load-hauling Tour-Pak luggage in seconds. You can easily remove the Tour-Pak luggage for easy maneuverability around town and reinstall it for an epic ride across the country. Tour-Pak Luggage and model-specific Docking Hardware Kits sold separately.

H. HOLDFAST SOLO TOUR-PAK LUGGAGE MOUNTING RACK

The Solo Tour-Pak Mounting Rack moves the Softail Tour-Pak luggage forward to a comfortable rider-supporting position. Designed for use with a solo seat, this Rack positions the Tour-Pak luggage over the fender to serve as a backrest for the rider. Tour-Pak can be repositioned forward or aft over a .75" range to maximize rider space. Simple fingertip operated latches release the rack from the docking hardware for easy removal.

Fits '18-later FLDE, FLHC, FLHCS, FLSE, FXBB, FXBBS and FXST models equipped with a solo seat. Installation requires separate purchase of model-specific Docking Hardware Kit.

50300174	Chrome.	\$209.95
50300176	Gloss Black.	\$209.95

I. HOLDFAST TWO-UP TOUR-PAK MOUNTING RACK

With the HoldFast Two-Up Tour-Pak Mounting Rack, you can change your riding style in seconds. With a simple pull of the HoldFast latches, you can convert your bike from a touring machine with a Tour-Pak to a street cruiser with a detachable sissy bar upright. When using a Tour-Pak, the rack is adjustable over a .75" range, allowing the Tour-Pak to be located for maximum passenger room and comfort.

Fits '18-later FLDE, FLHC and FLHCS models equipped with a two-up seat. Installation requires separate purchase of model-specific Docking Hardware Kit. FLHC and FLHCS models with oversized international registration plates may interfere with Luggage Rack and may require separate purchase of License Plate Relocation Kit P/N 67900472.

50300186	Chrome.	\$221.95
50300188	Gloss Black.	\$232.95

Fits '18-'21 FLSE models equipped with a two-up seat. Installation requires separate purchase of model-specific Docking Hardware Kit.

50300192	Gloss Black.	\$232.95
-----------------	--------------	-----------------

Notice: The prices appearing in this catalog are the manufacturer's suggested retail prices. Actual retail prices may vary.

Notice: The prices appearing in this catalog are the manufacturer's suggested retail prices. Actual retail prices may vary.

134 CRUISER

Suspension

A. PROFILE® LOW FRONT SUSPENSION*

Designed by Harley-Davidson and Showa®, this kit reduces the front fork length by over 1.0". This Profile® Low front suspension utilizes dual bending valve technology to preserve original ride quality. Springs are wound to allow a compliant, yet controlled ride. A perfect addition during the installation of chrome or gloss black lower fork sliders, the kit includes two fork springs, two damper tubes, seals and hardware.

45500427 \$149.95

Fits '18-later FLDE, FLHC, FLHCS, FLXL, FXBB, FXBBS, FXLR and FXST models. FLDE model requires separate purchase of Jiffystand P/N 50000156. FXBB, FXBBS and FXST models require separate purchase of Jiffy Stand P/N 50000127. FLHC and FLHCS models must be equipped with Profile Low Rear Suspension P/N 54000134 and requires separate purchase of Jiffystand P/N 50000156.

B. PROFILE LOW REAR SUSPENSION*

This suspension lowers the seat height approximately .75" while preserving ride quality. Spring and damping rates are tailored to ensure a controlled ride. Shock features multi-staged damping to ensure optimal performance under varying conditions. The pre-load adjuster allows easy access for setting proper sag according to rider's weight for optimal comfort. Kit includes one rear shock absorber.

54000134 \$413.95

Fits '18-later FLHC and FLHCS models. Installation requires separate purchase of Jiffy Stand P/N 50000127 if not equipped with Profile Low Front Suspension P/N 45500427.

54000143 \$413.95

Fits '18-later FXFB and FXFBS models. Installation requires separate purchase of Jiffy Stand P/N 50000127.

C. TALL REAR SHOCK*

This tall rear shock can be used to raise the motorcycle seat height for comfort or to increase lean angle for more cornering clearance during aggressive riding. Increased rear wheel travel may improve comfort and reduce suspension bottoming for some riders. Pre-load is adjustable using a Spanner Wrench (sold separately) to dial in sag based on weight of rider, passenger and luggage, for ideal handling and ride. Designed and validated by Harley-Davidson for fit and performance you can count on.

54000294 \$447.95

Fits '18-later Softail® models (except FLHC, FLHCS, FXFB, FXFBS, FLFB and FLFBS). Original Equipment on '22-later FXLRS and FXLRST models.



A. PROFILE LOW FRONT SUSPENSION



B./C. SOFTAIL REAR SUSPENSION



***WARNING:** Installation of any accessory suspension components may affect cornering clearance and jiffy stand operation. This could distract the rider, causing loss of control and death or serious injury.



***WARNING:** The Profile Low Front Spring Kit cannot be used independently and must be used with the appropriate Profile Rear Shock Lowering Kit. Installation of any accessory suspension components may affect cornering clearance and jiffy stand operation. This could distract the rider, causing loss of control and death or serious injury.

Notice: The prices appearing in this catalog are the manufacturer's suggested retail prices. Actual retail prices may vary.

CRUISER 135

Foot Controls

D. RIDER FOOTBOARD MOUNTS – CHROME

Complete the custom transformation by replacing the stock painted footboard brackets with brilliant chrome. The perfect complement to custom footboards, this kit is manufactured with Original Equipment components for proper fit, and are polished and plated to a brilliant finish. Kit includes chrome mounting hardware.

50500695 \$266.95

Fits '18-later FLDE, FLHC, FLHCS and FLXL models with rider footboards.

50500696 \$266.95

Fits '18-later FLFB and FLFBS models with rider footboards.



D. RIDER FOOTBOARD MOUNTS – CHROME

E. EXTENDED REACH FORWARD CONTROL KIT*

Stretch out in the saddle. This kit extends the rider foot controls a full 3.0" forward of the stock location, providing the tall rider a comfortable riding position. This comprehensive kit includes everything necessary for installation. Kit includes new black painted brake and shifter mounting assemblies, extended shift rod, brake line and all necessary hardware. The kit is compatible with Original Equipment or accessory footpegs, brake and shift levers and brake pedal pad and shifter peg.

50500840 \$605.95

Fits '18-later FXBR and FXBRS models with ABS. Not compatible with Engine Guards.

F. STANDARD FORWARD CONTROL KIT*

Stretch out for maximum comfort and style. This complete kit includes all components necessary to convert a mid control-equipped '18-later Softail® model to forward controls. Moves controls 7.5" forward from mid control foot position. Kit is available in chrome to match your customizing style.

Fits '18-later FXBB, FXBBS, FXLR, FXLRS, FXLRST and FXST models. Compatible with Original Equipment or Accessory Footpegs that fit those models.

50700061 Chrome \$547.95



E. EXTENDED REACH FORWARD CONTROL KIT



F. STANDARD FORWARD CONTROL KIT – CHROME

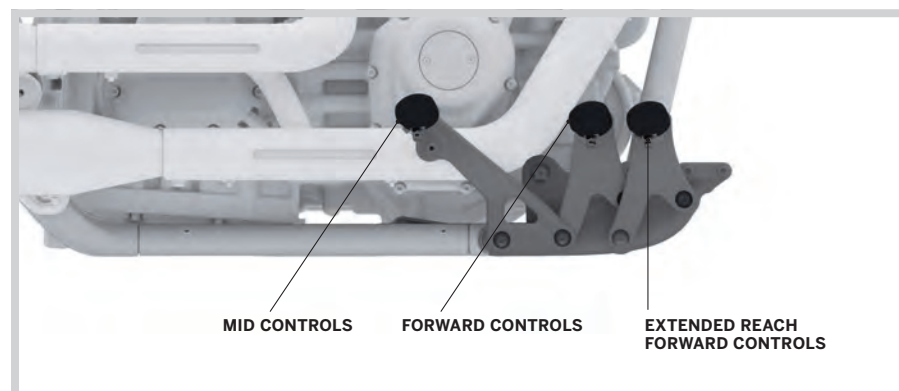

FOOT CONTROL POSITION COMPARISON



***WARNING:** Installation of this kit may affect cornering clearance. This could distract the rider, causing loss of control, resulting in death or serious injury.

Notice: The prices appearing in this catalog are the manufacturer's suggested retail prices. Actual retail prices may vary.

136 CRUISER

Foot Controls

MID-CONTROLS FOR SOFTAIL® MODELS

Moving foot pegs and controls from a forward to mid location on the motorcycle puts you in better position for aggressive riding. These mid-control options are a perfect solution for performance-oriented Softail model customization and will not compromise vehicle function or handling. Mid-Controls in Original Equipment and Accessory configurations can be mixed or matched depending on vehicle customization and additional accessories.

A. ORIGINAL EQUIPMENT MID-CONTROLS

These Mid Control Kits place the shift side and brake side mid-control components in the Original Equipment configuration.

50501988 Brake Side. **\$319.95**
Fits '18-later FLSB, FXFB and FXFBS models. Requires separate purchase of Original Equipment Mid-Controls - Shift Side P/N 50502090 and Screamin' Eagle® High Flow Exhaust System P/N 64900828 or P/N 64900829 or a custom exhaust system.

50502090 Shift Side. **\$213.95**
Fits '18-later FLSB, FXFB and FXFBS models. Requires separate purchase of Original Equipment Mid-Controls - Brake Side P/N 50501988 and Screamin' Eagle High Flow Exhaust System P/N 64900828 or P/N 64900829 or a custom exhaust system. Also requires separate purchase of Primary Housing P/N 36500105 and Primary Cover P/N 25700937, 25700941, 25700851 or 25700850 and necessary hardware and gaskets per service parts manual. Dominion™ Primary Covers will require separate purchase of Oil Fill Insert Kit P/N's 25700804, 25700805, 25700806, or 25700807. '18 FXFB and FXFBS require separate purchase of Cover P/N 25700933 and Gasket P/N 25701080, except when installing Dominion Primary Covers.



A. ORIGINAL EQUIPMENT MID-CONTROLS FOR SOFTAIL MODELS – BRAKE SIDE



A. MID-CONTROLS FOR SOFTAIL MODELS – SHIFT SIDE



B. ACCESSORY MID-CONTROLS – BRAKE SIDE



B. ACCESSORY MID-CONTROLS – SHIFT SIDE



A. ORIGINAL EQUIPMENT MID-CONTROLS – BRAKE AND SHIFT SIDE



B. ACCESSORY MID-CONTROLS – BRAKE AND SHIFT SIDE



C. ORIGINAL EQUIPMENT FOOTBOARD-TO-FOOTPEG CONVERSION KIT.



C. BOARD-TO-PEG CONVERSION KIT



C. BOARD-TO-PEG CONVERSION KIT

CRUISER 137

Foot Controls

C. FOOTBOARD-TO-FOOTPEG CONVERSION KIT.

Add an aggressive look to your FL Softail® motorcycle. These support kits are designed to allow installation of mini Footboards and footpegs. Kit Includes left and right mounting brackets and all necessary installation hardware. Mini footboards and footpegs sold separately.

50501640 **\$213.95**
Fits '18-later Softail® models originally equipped with footboards. Requires separate purchase of '18-later Original Equipment or accessory Softail Standard rider Footpegs.

138 CRUISER

Foot Controls

A. BILLET STYLE REAR BRAKE LEVER – FORWARD CONTROLS

Styled to complement our billet style mirror stems and hand and foot controls, these slotted Rear Brake Levers are forged from aluminum, then machined and polished for a beautiful, custom look. Available in your choice of satin black powder coat or edge cut black anodized and machined aluminum finishes. Brake pedal pads sold separately.

Fits '18-later Softail® models equipped with forward controls (except FXBR and FXBRS). Also fits '18-later FXBB, FXBBS, and FXLR models and '20-later FXLRS, FXLRST and FXST models equipped with Standard Forward Control Kits P/N 50700060 or 50700061.

41600219	Satin Black.	\$221.95
41600220	Edge Cut.	\$221.95

B. BILLET STYLE SHIFT LEVERS – FORWARD CONTROLS

Forged from aluminum, these Billet Style Shift Levers are machined and polished for a beautiful, custom look. Available in your choice of mirror chrome, satin black powder coat or edge cut black anodized and machined aluminum finishes. Includes chrome hardware. Shifter pegs sold separately.

Fits '18-later FLSB, FXDRS, FXFB, FXFBS, FXBR and FXBRS models equipped with forward controls and '18-later FLDE, FLFB, FLFBS, FLHC, FLHCS and FLSL models equipped with footboards. Also fits '18-later FXBB, FXBBS, and FXLR models and '20-later FXLRS, FXLRST and FXST models equipped with Standard Forward Control Kits P/N 50700060 or 50700061.

33600167	Chrome.	\$111.95
33600168	Satin Black.	\$111.95

C. BILLET STYLE HEEL/TOE SHIFT LEVER

Add a traditional heel-toe shift action and a contemporary new look. These Billet Style Shift Levers are forged from aluminum, then machined and polished for a beautiful, custom finish. Available in your choice of mirror chrome, satin black powder coat or edge cut black anodized and machined aluminum finishes. Kit includes a front and rear lever and chrome hardware.

Fits '18-later FLDE, FLFB, FLFBS, FLHC, FLHCS and FLSL models equipped with footboards.

33600164	Chrome.	\$178.95
33600165	Satin Black.	\$178.95
33600166	Edge Cut.	\$178.95



A. BILLET STYLE REAR BRAKE LEVER – FORWARD CONTROLS – SATIN BLACK



B. BILLET STYLE REAR SHIFT LEVER – FORWARD CONTROLS – CHROME



C. BILLET STYLE HEEL/TOE SHIFT LEVER – CHROME



A. BILLET STYLE REAR BRAKE LEVER – FORWARD CONTROLS



B. BILLET STYLE REAR SHIFT LEVER – FORWARD CONTROLS



C. BILLET STYLE HEEL/TOE SHIFT LEVER



D. HEEL SHIFT LEVER – CHROME



D. HEEL SHIFT LEVER – BLACK



E. SHIFT ROD LEVER – BLACK

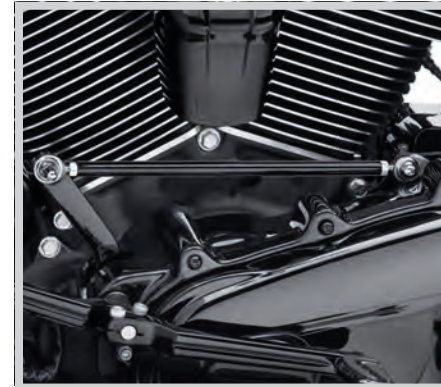

F. CUSTOM GEAR SHIFT LINKAGE – ROUND GLOSS BLACK



G. CUSTOM GEAR SHIFT LINKAGES

CRUISER 139

Foot Controls

D. HEEL SHIFTER LEVER

Add the convenience of a heel shifter to your footboard-equipped Softail® model. This traditional Heel Shifter Lever permits you to upshift with a downward tap of your boot heel – eliminating the need to wedge your toe under the forward lever and reducing wear on the top of your boot. Styled to match the Original Equipment toe shifter, this easy-to-install kit includes the heel shift lever, extended shifter shaft, shifter peg and mounting hardware.

33600224	Chrome.	\$94.95
Fits '18-later FL Softail models equipped with footboards.		

33600314	Satin Black.	\$104.95
Fits '18-later FL Softail® models equipped with footboards.		

E. SHIFT ROD LEVER – BLACK

Complete your bike's black-out look. This gloss black shift rod lever replaces the OE or Accessory chrome lever to create a cohesive, black-out look across your bike.

33600318		\$89.95
Fits '18-later FL Softail models.		

F. CUSTOM GEAR SHIFT LINKAGE – ROUND GLOSS BLACK

Add the finishing touch to your blacked-out ride. This Gloss Black Shift Linkage is easy to install and includes a transmission lever cover and decorative acorn nuts and bolts for a complete custom look.

33600259		\$111.95
Fits '86-later Softail (except '18-later FXBB, FXBBS, FXLR, FXLRS, FXLRST and '20-later FXST), Touring and Trike models. (Does not fit '97-'99 FLSTS or models equipped with Softail Extended Reach Forward Controls.)		

G. CUSTOM GEAR SHIFT LINKAGES

Kick your custom into gear with this collection of high-quality custom shift linkages. Available in a variety of designs to match your bike's style, these linkages feature aircraft-quality rod ends for easy adjustment and smooth operation. The easy-to-install linkage kit also includes a transmission lever cover for '86-'17 Softail and '86-'16 Touring and Trike models, and decorative acorn nuts and bolts for a complete custom look.

Fits '86-later Softail (except '18-later FXBB, FXBBS, FXLR, FXLRS, FXLRST and '20-later FXST), Touring and Trike models. (Does not fit '97-'99 FLSTS or models equipped with Softail Extended Reach Forward Controls.)

1. 34018-08	Slotted Black Anodized.	\$142.95
2. 34850-09	Skull.	\$139.95
3. 33801-09	Harley-Davidson Script.	\$139.95
4. 33760-09	Slotted with Bar & Shield Logo.	\$142.95
5. 33814-98A	Round.	\$99.95

Notice: The prices appearing in this catalog are the manufacturer's suggested retail prices. Actual retail prices may vary.

Notice: The prices appearing in this catalog are the manufacturer's suggested retail prices. Actual retail prices may vary.

140 CRUISER

Foot Controls

A. PASSENGER FOOTPEG SUPPORT KIT

Add footpeg to your solo seat-equipped '18-later Softail® motorcycle. Available in chrome or gloss black finish, the kit includes left and right footpeg supports and mounting hardware. Footpegs and footpeg hardware sold separately.

Fits '18-later Softail (except FXDRS) models. Does not fit with Swingarm Pivot Bolt Cover P/N 61400344.

50500769	Gloss Black.	\$107.95
50500771	Chrome.	\$160.95

B. PASSENGER FOOTPEG MOUNTING KIT – FXDR® 114

A necessary addition when converting your solo seat FXDR® 114 model to a two-up passenger-carrying ride. Kit includes black mounting adapters and brackets (footpegs sold separately).

50501128	Black.	\$199.95
-----------------	--------	-----------------

Fits '19-'20 FXDRS models.

C. PASSENGER FOOTBOARD SUPPORT KIT

Add the comfort and convenience of passenger footboard to your motorcycle. These brackets and supports are designed to allow installation of Passenger Footboards (sold separately). Brackets and Supports are sold separately.

Fits '18-later Softail models equipped with Passenger Footboard Support Bracket P/N 50501117 or P/N 50501118. Requires separate purchase of model-specific Passenger Footboard Support Bracket and Passenger Footboards.

50501114	Black.	\$168.95
50501113	Chrome.	\$168.95

D. PASSENGER FOOTBOARD SUPPORT KIT

Add the comfort and convenience of passenger footboard to your motorcycle. These brackets and supports are designed to allow installation of Passenger Footboards (sold separately). Brackets and Supports are sold separately.

50501118 Black. **\$116.95**
Fits '18-later FLDE, FLHC, FLHCS and FLSE models. Requires separate purchase of Passenger Footboard Supports and Passenger Footboards.

50501117 Black. **\$116.95**
Fits '18-later FLFB, FLFBS, FLSE, FXBB, FXBBS, FXBR, FXBRS, FXLR, FXLRS, FXLRST, FXRST and FXST models. Requires separate purchase of Passenger Footboard Supports and Passenger Footboards.



A. PASSENGER FOOTPEG SUPPORT KIT – GLOSS BLACK



A. PASSENGER FOOTPEG SUPPORT KIT – CHROME



B. PASSENGER FOOTPEG MOUNTING KIT – FXDR 114



C. PASSENGER FOOTBOARD SUPPORT KIT – CHROME



C. PASSENGER FOOTBOARD SUPPORT KIT – BLACK



D. PASSENGER FOOTBOARD SUPPORT KIT (50501118 SHOWN)



D. PASSENGER FOOTBOARD SUPPORT KIT (50501117 SHOWN)



E. PASSENGER FOOTBOARD PAN KIT – CHROME, CLASSIC STYLE



E. PASSENGER FOOTBOARD PAN KIT – CHROME, CONTEMPORARY STYLE



F. PASSENGER FOOTBOARD PAN KIT – GLOSS BLACK, CLASSIC STYLE



F. PASSENGER FOOTBOARD PAN KIT – GLOSS BLACK, CONTEMPORARY STYLE

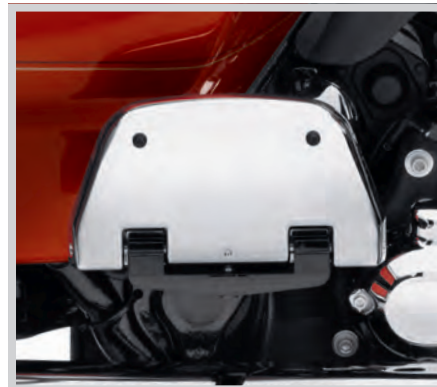

G. TRADITIONAL PASSENGER FOOTBOARD PANS – CHROME



G. TRADITIONAL PASSENGER FOOTBOARD PAN – GLOSS BLACK



H. HALF-MOON PASSENGER FOOTBOARD PANS – GLOSS BLACK

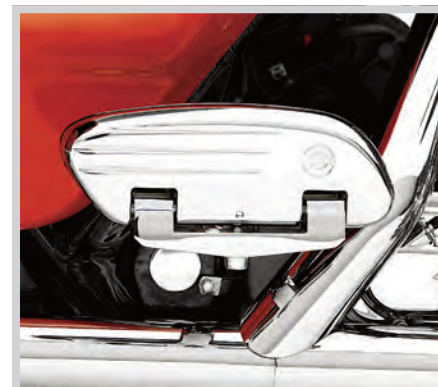

I. SWEEP WING PASSENGER FOOTBOARD PANS – CHROME GROOVED

CRUISER 141

Foot Controls

E. PASSENGER FOOTBOARD PAN KIT – CHROME

Replace the factory black painted passenger footboard with the custom look of smooth chrome. These chrome-plated Footboard Pans are ready to install using your Original Equipment hardware and the kit includes left- and right-side Footboard Pans. Just add your choice of Footboard Insert for the finishing touch. Footboard Supports sold separately.

Fits '06-'17 Dyna®, '18-later Softail® (except FXDRS, FXFB and FXFBS) and '86-later Touring models equipped with passenger footboard supports. Does not fit Trike models.

50501144	Classic Style.	\$180.95
50501147	Contemporary Style.	\$180.95

F. PASSENGER FOOTBOARD PAN KIT – BLACK

Complete the blacked-out transformation. Replace your chrome Passenger Footboard Pans with sinister black. Kit includes left- and right-side Footboard Pans and is installed using the Original Equipment hardware. Custom Footboard Inserts and Footboard Supports sold separately.

Fits '06-'17 Dyna, '18-later Softail (except FXDRS, FXFB and FXFBS) and '86-later Touring models equipped with passenger footboard supports. Does not fit Trike models.

50501610	Classic Style.	\$180.95
50501611	Contemporary Style.	\$180.95

G. TRADITIONAL PASSENGER FOOTBOARD PANS

Replace the factory black painted passenger footboard with the custom look of smooth chrome. The kit includes left- and right-hand traditional D-shaped footboard pans, ready to install with your Original Equipment hardware. Footboard inserts and footboard supports sold separately.

50752-04 Chrome. **\$180.95**
Fits '06-'17 Dyna, '00-later Softail (except FXDRS, FXFB and FXFBS) and '86-later Touring and Trike models equipped with passenger footboard supports.

50501799 Gloss Black. **\$180.95**
Fits '06-'17 Dyna, '00-later Softail (except FXDRS, FXFB and FXFBS) and '86-later Touring and Trike models equipped with passenger footboard supports.

H. HALF-MOON PASSENGER FOOTBOARD PANS AND INSERTS

Styled to match the Half-Moon Rider Footboards, these classic passenger footboards add both style and comfort to your nostalgic ride. Available in mirror-finish chrome or gloss black finish, the kit includes left and right footboard pan and vibration-isolation footboard inserts. Model-specific footboard mounts are sold separately.

Fits '06-'17 Dyna, '00-later Softail (except FXDRS, FXFB and FXFBS) and '86-later Touring models equipped with passenger footboard supports. Does not fit Trike models.

50807-08	Chrome.	\$221.95
50810-08	Gloss Black.	\$209.95

I. SWEEP WING PASSENGER FOOTBOARD PANS

These unique Sweep Wing Passenger Footboard pans complement the Sweep Wing Rider Footboard shape and allow you to replace the Original Equipment passenger footpegs on certain models with footboards. When folded, the footboard displays a mirror chrome surface in your choice of smooth or "ball-milled" grooved design. Footboard inserts and footboard supports sold separately.

Fits '06-'17 Dyna, '00-later Softail (except FXDRS, FXFB and FXFBS) and '86-later Touring models equipped with passenger footboard supports. Does not fit Trike models.

50357-04	Chrome – Grooved.	\$180.95
50716-04	Chrome – Smooth.	\$180.95

142 CRUISER

Engine Guards

A. FLAT-OUT BAR*

Get tip-over protection with sleek West Coast style. The Flat-Out Bar provides limited cosmetic vehicle protection to the front of the motorcycle in a low-speed tip-over event.

Fits '18-later Softail® models (except FXDRS). '22-later FXLRST and FXRST requires separate purchase of Flat-Out Bar Adapter Kit P/N 47200927. Does not fit with Extended Reach Forward Control Kits.

49000232	Chrome.	\$288.95
49000231	Gloss Black.	\$288.95

B. FLAT-OUT BAR ADAPTER KIT

Replaces the stock fairing support to enable installation of Flat-Out Bar or Traditional and Mustache engine guards.

47200927 **\$132.95**

Fits '22-later FXLRST and FXRST models. Required for installation of Flat-Out Bar, Mustache Engine Guard, and Traditional Engine Guards.

C. MUSTACHE ENGINE GUARD*

Combine classic shape and modern function for a unique twist on engine protection. The flow of this engine guard complements the bike's traditional style while the gracefully curved upper section incorporates highway pegs into the shape. The integrated rubber pads offer a comfortable and slip-resistant cushion for your feet while traveling the open road. One-piece engine guard kit includes all required mounting hardware.

Fits '18-later Softail models (except FXDRS). '22-later FXLRST and FXRST requires separate purchase of Flat-Out Bar Adapter Kit P/N 47200927. Does not fit with Extended Reach Forward Control Kits.

49000140	Chrome.	\$314.95
49000141	Gloss Black.	\$314.95

D. ENGINE GUARD KIT*

Protect your bike without sacrificing ground clearance or style. The one-piece Engine Guard is designed to complement the lines of the motorcycle and the available chrome or gloss black finish adds the perfect finishing touch.

Fits '18-later Softail models (except FXDRS). '22-later FXLRST and FXRST requires separate purchase of Flat-Out Bar Adapter Kit P/N 47200927. Does not fit with Extended Reach Forward Control Kits.

49000138	Chrome.	\$263.95
49000139	Gloss Black.	\$252.95

E. SOFT LOWERS

Extend your riding season. Full-coverage Soft Lower provide wind and mud protection for the rider's legs and boots and minimize cold updrafts as the weather changes. Covers are custom shaped to hug the engine guard to minimize flapping and they simply clip in place for speedy installation as the weather changes. Two-way zippered outer edge accommodates guard mounted highway pegs in almost any position. Reflective piping provides added visibility.

57100366 **\$121.95**

Fits '18-later Softail models (except FXDRS) equipped with Engine Guard Kit P/Ns 49000138 or 49000139. Does not fit with Mustache Engine Guards or Extended Reach Forward Controls.



A. FLAT OUT BAR – GLOSS BLACK



B. FLAT OUT BAR ADAPTER KIT



C. MUSTACHE ENGINE GUARD – CHROME



C. MUSTACHE ENGINE GUARD – GLOSS BLACK



D. ENGINE GUARD KIT – CHROME



D. ENGINE GUARD KIT – GLOSS BLACK



E. SOFT LOWERS



F. LOWER FORK SLIDERS – CHROME (45500400 SHOWN)



G. LOWER FORK SLIDERS – GLOSS BLACK (45500403 SHOWN)



H. FRONT BRAKE CALIPER KIT – CHROME (SHOWN WITH CLASSIC CHROME CALIPER INSERT)



H. FRONT BRAKE CALIPER KIT – RED

CRUISER 143

Chassis Trim – Front End

F. LOWER FORK SLIDERS – CHROME

Competitively priced, these chrome-plated Lower Fork Sliders give your bike upfront style. To ensure proper fitment and function, these sliders are manufactured from Original Equipment components. Form follows function, with polished, chrome-plating and a stamped Harley-Davidson logo for product identification. A perfect addition during the installation of Profile® Low Front suspension components, this kit includes right and left sliders, bottom axle retainer, axle retainer bolts and oil seals.

45500400 **\$514.95**

Fits '18-later FLDE, FLHC, FLHCS and FLSL models.

45500406 **\$514.95**

Fits '18-later FXLR models. Does not fit FXLRS and FXLRST models.

45500401 **\$514.95**

Fits '18-later FXBB, FXBBS and FXST models.

45500402 **\$514.95**

Fits '18-later FLFB and FLFBS models.

G. LOWER FORK SLIDERS – GLOSS BLACK

These gloss black coated sliders are the ultimate extension to your bike's dark side and make a perfect custom addition to your blacked-out Softail® model. Manufactured to Original Equipment specifications, the durable black coating is a great match to other H-D® black components. A perfect addition during the installation of Profile Low Front suspension components, this includes right and left sliders, bottom axle retainers, drain screws, axle retainer bolts and oil seals.

45500403 **\$478.95**

Fits '18-later FLDE, FLHC, FLHCS and FLSL models.

45500404 **\$478.95**

Fits '18-later FLFB and FLFBS models.

45500405 **\$478.95**

Fits '18-later FXLR models. Does not fit FXLRS and FXLRST models.

H. BRAKE CALIPER KIT – FRONT, SINGLE DISC

Manufactured from Original Equipment components for proven performance, these calipers will add a stylish touch to the stock bike or add the perfect finish to a complete custom equipped with chrome or blacked-out wheels, rotors and fork sliders.

Fits '15-later Softail models (except FXDRS, FXFB, FXFBS FXLRS, FXLRST, FXRST and FXSE). Kit includes brake pads.

41300148 Chrome. **\$425.95**

41300152 Red. **\$266.95**

***WARNING:** Front and/or rear guards are not intended to provide protection from bodily injury in a collision with another vehicle or any other object.

***WARNING:** Engine guards may provide limited leg and cosmetic vehicle protection under unique circumstances (fall over while stopped, very low speed slide). They are not made nor intended to provide protection from bodily injury in a collision with another vehicle or any other object.

***WARNING:** Do not use engine guard footpegs under normal stop and go operating conditions. Doing so could result in death or serious injury.

Notice: The prices appearing in this catalog are the manufacturer's suggested retail prices. Actual retail prices may vary.

Notice: The prices appearing in this catalog are the manufacturer's suggested retail prices. Actual retail prices may vary.

SOFTAIL

144 CRUISER

Chassis Trim – Front End

A. HARLEY-DAVIDSON® AUDIO POWERED BY ROCKFORD FOSGATE® – INNER FAIRING AUDIO KIT

A high-performance motorcycle deserves high-output audio. This kit was designed alongside the Low Rider® ST for outstanding performance and an ideal fit within the fairing. A powerful, intelligent amplifier with digital signal processing (DSP) technology developed jointly by Harley-Davidson and Rockford Fosgate® is engineered to perform in the demanding motorcycle environment. Connects to your mobile device via Bluetooth to play stored or streaming audio through a pair of built-in two-way speakers.

- Marine grade two-way speakers include a pair of 5.25" woofers and two remote tweeters aimed at the rider's ears for great audio performance

- Lightweight design has minimal impact vehicle dynamics and performance

- Plug-and play installation. One assembly includes the amplifier, speakers and housing, which replaces the original equipment inner fairing.

- Two simple wiring connections power the unit

- Uses Bluetooth 4.2 for a strong wireless connection to most devices with minimal compression for outstanding sound quality

- Connectivity with the Harley-Davidson® Audio powered by Rockford Fosgate® mobile app offers unique features like Automatic Volume Control (AVC), adjustable 7-Band EQ, and step by step system configurator.

- Compact amplifier mounts within the fairing. 250 watts of amplifier power (125 x 2 @ 4ohms / 125 x 2 @ 2ohms) for crisp, clear sound quality at any volume. Overcomes bike, environment, and helmet sound-limiting variables at all speeds

76200037 **\$1,050.95**
Fits '22-later FXLRST models. Original Equipment on FXRST models.



A. HARLEY-DAVIDSON® AUDIO POWERED BY ROCKFORD FOSGATE® – INNER FAIRING AUDIO KIT



B. FAT BOY NACELLE KIT – GLOSS BLACK (SHOWN WITH BLACK HEADLAMP BEZEL)



C. FAT BOY NACELLE HEADLAMP BEZEL – GLOSS BLACK



D. UPPER FORK SLIDER COVERS – CHROME



E. UPPER FORK SLIDER COVERS – GLOSS BLACK



F. OIL COOLER COVER KIT – CHROME



G. COIL COVER – CHROME



G. COIL COVER – BLACK MACHINE CUT



G. COIL COVER – GLOSS BLACK



G. COIL COVER – BLACK MACHINE CUT



H. DEFIANCE GAUGE TRIM – BLACK ANODIZED



I. HEADLAMP TRIM RING – 7" GLOSS BLACK

B. FAT BOY® NACELLE KIT

Take your Fat Boy® model in a new styling direction. Manufactured from Original Equipment components for a perfect fit, these Nacelle Kits are a direct replacement for the stock satin chrome nacelle. Available in gloss black finish, these kits are just the start on your journey to build a one-of-a-kind custom ride. Add matching lower fork sliders, upper fork slider covers and axle nut covers to complete the conversion. The 3-piece kit includes nacelle housing and two back panels. Black Headlamp Bezel P/N 61400509 is sold separately.

61300811 Gloss Black. **\$319.95**
Fits '18-later FLFB and FLFBS models.

C. FAT BOY NACELLE HEADLAMP BEZEL – GLOSS BLACK

Complete the transition to the dark side. This gloss black Headlamp Bezel replaces the Original Equipment chrome bezel, and is the perfect match for the Fat Boy Nacelle Kit P/N 61300811.

61400509 **\$89.95**
Fits '18-later FLFB and FLFBS models.

D. UPPER FORK SLIDER COVERS – CHROME

When used with H-D® Genuine Motor Accessory Chrome Lower Fork Sliders, you've got a front end that's completely chromed and an appearance that's utterly impressive. Kit includes left and right cover.

45800133 Chrome. **\$102.95**
Fits '18-later FLFB and FLFBS models.

E. UPPER FORK SLIDER COVERS – GLOSS BLACK

When combined with matching Lower Fork Sliders, these Gloss Black Upper Fork Slider Covers complete the blacked-out transformation. Manufactured from Original Equipment components for superior fit, the black finish matches the available black fork sliders and nacelle kit for a unified look. Kit includes left and right cover.

45800134 Gloss Black. **\$102.95**
Fits '18-later FLFB and FLFBS models.

F. OIL COOLER COVER

The cover fills the area between the frame downtubes for a complete custom look, without disturbing the airflow across the cooler's surface. This Oil Cooler Cover replaces the plastic surround, and because it hugs the contours of the cooler body, it does not interfere with engine guard installation. Available in your choice of chrome or gloss black finish, the easy-to-install cover kit includes all required mounting hardware.

Fits '18-later Softail® models.

62500026 Chrome. **\$116.95**

CRUISER 145

Chassis Trim – Front End

G. COIL COVER

Create a custom look in minutes. Dressed in classic chrome or rich, gloss black, these coil covers make it easy for you to complete your chromed- or blacked-out look and feature a Bar & Shield emboss in contrasting gloss black on the chrome cover or chrome on the gloss black cover, creating a unique look. To install, simply remove the OE screw, add the cover and the included screw and one of the most visible parts of your bike is now customized. Includes all necessary hardware.

Fits '18-later Softail® models.

57300214	Chrome.	\$66.95
57300213	Gloss Black.	\$64.95
57300289	Machine Cut.	\$73.95

H. GAUGE BEZELS – DEFIANCE COLLECTION

The perfect finishing touch. Defiance Collection Gauge Bezels add a custom detail to the place you constantly look – your instrument cluster. Accented with deep grooves, these machined aluminum rings cover the factory gauge surround adding texture and visual interest to the dash. Available in black anodized finish, these self-adhesive rings are easy to install.

61400440 5" Tank Gauge – Black Anodized. **\$59.95**
Fits '18-later FLDE, FLHC, FLHCS, and FLSL models.

61400437 4" Tank Gauge – Black Anodized. **\$74.95**
Fits '99-'22 XL (except XL1200X, XL1200CX, and XL1200XS), '11-'13 FXS, '13-'17 FXSB, '13-'14 FXSBSE, '98-'13 Road Glide®, '14-'17 FXDL, and '18-later FXFB, FXFBS, FXLR, and FXLRS models.

I. HEADLAMP TRIM RING – GLOSS BLACK

Finish the sinister look by replacing the Original Equipment chrome headlamp trim ring with sinister black. Easy to install, the ring's rich black surface matches the stock headlamp shell finish for a unified look.

61400573 7" Headlamp. **\$47.95**
Fits '18-later FLDE, FLHC, FLHCS, FLFB and FLSL models.

J. CONSOLE KIT – GLOSS BLACK

Lead the way to the dark side. This blacked-out Console Kit includes the major components required to change the chrome or satin chrome console to a dark custom look. Easy to install, this Black Console Kit instantly transforms the view over the tank. Manufactured from Original Equipment components for superior fit and finish, the kit includes black instrument console, tank strap, console insert and installation hardware.

70900817 **\$319.95**
Fits '18-later FLFB, FLFBS, and FLFB models.



J. CONSOLE KIT – GLOSS BLACK

Notice: The prices appearing in this catalog are the manufacturer's suggested retail prices. Actual retail prices may vary.

Notice: The prices appearing in this catalog are the manufacturer's suggested retail prices. Actual retail prices may vary.

SOFTAIL

148 CRUISER

Chassis Trim – Rear End

A. REAR FENDER SUPPORTS

Make a bold statement on the rear of your bike by swapping out the stock Fender Supports for these chrome or black versions. Manufactured from Original Equipment components to ensure superior fit and finish, these Fender Supports continue your styling direction to the back of the bike. These Fender Supports are the ideal finishing touch and the perfect complement to available gloss black or chrome passenger sissy bars and luggage racks.

59500769	Chrome.	\$368.95
Fits '18-later FLHC and FLHCS models.		
59500770	Gloss Black.	\$368.95
Fits '18-later FLDE, FLHC and FLHCS models.		
59500766	Gloss Black.	\$378.95
Fits '18-later FLFB and FLFBS models.		
59500767	Gloss Black.	\$378.95
Fits '18-later FXLR and FXLRS models.		
59500771	Gloss Black.	\$368.95
Fits '18-'21 FLFB and '22-later FXLRST and FXRST models.		



A. REAR FENDER SUPPORTS – CHROME



A. REAR FENDER SUPPORTS – GLOSS BLACK

Notice: The prices appearing in this catalog are the manufacturer's suggested retail prices. Actual retail prices may vary.

CRUISER 149

Tank Trim

B. FLUSH-MOUNT FUEL CAP AND LEFT SIDE TANK CAP KIT

Emphasize the long and lean look of the fuel tank. This Flush-Mount Fuel Cap and Left Side Tank Cap Kit offers a pop-up filler design that when installed and sealed looks identical to the flush mount cap. A simple push and the fuel filler cap pops up to provide ample grip, even while wearing gloves. The Left Side Tank Cap is a decorative piece that replaces the Original Equipment trim. The complete kit includes fuel cap, left side tank cap and two trim rings.

Fits '18-'21 FLDE, FLFB, FLFBS, FLHC, FLHCS, FLFB, FLFL, FXLR and FXLRS models.

61100131	Chrome.	\$129.95
61100132	Gloss Black.	\$129.95



B. FLUSH-MOUNT FUEL CAP AND LEFT SIDE TANK CAP – CHROME

C. FLUSH-MOUNT FUEL CAP

Emphasize the long and lean look of the fuel tank. This Flush-Mount Fuel Cap Kit offers a pop-up filler design that replaces the Original Equipment twist-on fuel cap. A simple push and the fuel filler cap pops up to provide ample grip, even while wearing gloves. Easy to install, the cap assembly screws into position and the self-adhesive decorative ring finishes the look. Complete kit includes pop-up cap and matching trim ring.

Fits '22-later FLFB, FLFBS, FLHC, FLHCS, FLFB, FXLRST and FXRST models. Also fits '23-later FXBR models.

61100210	Gloss Black.	\$85.95
61100211	Chrome.	\$85.95

Fits '18-later FXBB, FXBRS, FXST, '18-'20 FXBR and '21-later FXBBS.

61100133	Chrome.	\$84.95
61100134	Gloss Black.	\$84.95

Fits '18-later FXFB and FXFBS models.

61100136	Gloss Black.	\$84.95
-----------------	--------------	----------------

Fits '20 FXDRS models.

61100158	Gloss Black.	\$107.95
-----------------	--------------	-----------------



B. FLUSH-MOUNT FUEL CAP AND LEFT SIDE TANK CAP – GLOSS BLACK

D. CUSTOM FUEL CAPS AND TANK TRIM

Add a custom touch to your tank. Styled to reflect your attitude, these elegantly constructed fuel caps are the perfect match for your ride. The Right Side Fuel Cap is easy to install and features a ratcheting design to ensure that the design faces the correct direction. And the Left Side Decorative Fuel Tank Caps mirror the fuel cap design for a symmetrical view over the tank.

Right Side Fuel Caps

Fits '92-'22 XL, '92-'17 Dyna® (except '04-later FXD and FXDX, '05-'06 FXDC and '07 FXDSE), '00-later Softail®, (except '18-later FXFB and FXFBS, FXST and '07-'08 FXSTSSE), '94-later Road King® and '15-later Freewheeler® models. Does not fit models equipped with Original Equipment locking or tethered fuel caps. Use on '13-'14 FXSBSE requires removal of stock flush mount trim ring..

61100180	Machine Cut.	\$116.95
61100107A	Dominion™ Gloss Black.	\$99.95
61100093B	Gloss Black.	\$38.95
61100076	Brass Collection.	\$129.95
61100126A	Diamond Black.	\$63.95
61100103A	Black Skull.	\$64.95
61100125A	Chrome Skull.	\$64.95

Left Side Decorative Tank Trim

Fits '18-'21 Softail models (except FXBB, FXBBS, FXBR, FXBRS, FXDRS, FXFB and FXFBS).

57300186	Dominion Gloss Black.	\$95.95
57300236	Gloss Black.	\$38.95
57300165	Brass Collection.	\$129.95
57300151	Diamond Black.	\$54.95
57300216	Black Skull.	\$54.95
57300149	Chrome Skull.	\$54.95



C. FLUSH-MOUNT FUEL CAP (61100134 SHOWN ON STREET BOB)



D. CUSTOM FUEL CAP AND TANK TRIM – MACHINE CUT



D. CUSTOM FUEL CAP AND TANK TRIM – BLACK SKULL

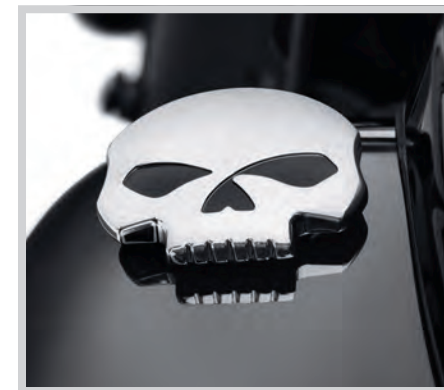

D. CUSTOM FUEL CAP AND TANK TRIM – CHROME SKULL

Notice: The prices appearing in this catalog are the manufacturer's suggested retail prices. Actual retail prices may vary.

SOFTAIL

150 CRUISER

Windshields – FX Softail® & Springer™

A. QUICK-RELEASE COMPACT WINDSHIELD

Combine the classic Harley-Davidson® windshield shape with a revolutionary attachment system and you have the best of style and function.

Fits '06-'17 FXDWG, '13-'17 FXSB and FXSBSE and '18-'20 FXBR and FXBRS models.

58387-06 18" Clear – Polished Braces. **\$411.95**
Windshield dimensions: Overall height – 26.8"; width – 19.5".

58444-06 14" Light Smoke – Polished Braces. **\$416.95**
Windshield dimensions: Overall height – 22.8"; width – 19.5".

B. QUICK-RELEASE SUPER SPORT WINDSHIELD

Reduces the pounding wind and shower of bugs, but keeps the wind-in-the-hair feeling.

57301-06 21" Clear – Polished Braces. **\$406.95**
Fits '06-'17 FXDWG, '13-'17 FXSB and FXSBSE and '18-'20 FXBR and FXBRS models. Windshield dimensions: Overall height – 25.0"; width – 20.1".

C. H-D® DETACHABLES™ SUPER SPORT WINDSHIELD

The windshield mounts to the fork tubes with H-D® Detachables™ Docking Hardware (sold separately) for easy on-and-off convenience and a quick return to a sporting profile.

57965-97A 18" Light Smoke. **\$310.95**
Fits '93-'05 FXDWG, '80-'86 FXWG and '84-'15 FXST, FXSTB and FXSTC models. Use Docking Hardware Kit P/N 58350-96. Windshield dimensions: Overall height – 22.3"; width – 17.8".

Shown with:

DOCKING HARDWARE FOR H-D DETACHABLES WINDSHIELDS

58907-96B Springer™ – Polished. **\$97.95**
Required for installation of H-D Detachables Windshields on and '93-'09 FXSTS, FXSTSB and '09 FXSTSSE, '97-'11 FLSTS, FLSTSB and FLSTSC models.

58350-96 For 41mm Forks. **\$86.95**
Required for installation of H-D Detachables Windshields on '93-'05 FXDWG, '80-'86 FXWG and '84-'15 FXST, FXSTB and FXSTC models.

58397-00 For Softail® Deuce™. **\$86.95**
Required for installation of H-D Detachables Windshields on '00-'07 FXSTD models. Does not fit FXSTDSE models.

D. H-D DETACHABLES COMPACT WINDSHIELD FOR SOFTAIL® SPRINGER™ MODELS

Fits '97-'03 FLSTS, '05-'07 FLSTSC and '93-'09 FXSTS, FXSTSB and '09 FXSTSSE models. Installation requires the separate purchase of Windshield Docking Hardware Kit P/N 58907-96B (chrome) or 58165-09 (black). (Will fit with or without auxiliary lighting.) Will not fit with Chrome Billet Mini Tach Mounts.

58770-96 18" Clear – Polished Braces. **\$385.95**
Windshield dimensions: Overall height – 26.8"; width – 19.9".

Shown with:

DOCKING HARDWARE FOR H-D DETACHABLES WINDSHIELDS

Required for installation of H-D Detachables Windshields on '97-'11 FLSTS, FLSTSB and FLSTSC and '93-'09 FXSTS, FXSTSB and '09 FXSTSSE models.

58907-96B Springer™ – Polished. **\$97.95**

58165-09 Springer – Black. **\$109.95**



A. QUICK-RELEASE COMPACT WINDSHIELD – 18" CLEAR



A. QUICK-RELEASE COMPACT WINDSHIELD – 14" LIGHT SMOKE



B. QUICK-RELEASE SUPER SPORT WINDSHIELD



C. H-D DETACHABLES SUPER SPORT WINDSHIELD



D. H-D DETACHABLES COMPACT WINDSHIELD – POLISHED BRACES



D. H-D DETACHABLES COMPACT WINDSHIELD – GLOSS BLACK BRACES

CRUISER 151

Windshields – FL Softail®

E. KING-SIZE H-D® DETACHABLES™ WINDSHIELD FOR FL SOFTAIL® MODELS – POLISHED BRACES

Styled to complement the beefy FL Softail® front headlamp, this windshield can be installed or removed in seconds without tools, keeping your bike ready for the open road or for a run down Main Street. The windshield is formed from hard-coated polycarbonate to resist scratching and abrasion and is available with traditional polished braces and mounting brackets to blend with your customizing style. Mounting brackets are supported by molded-rubber bushings for improved isolation. Windshield kit includes all the hardware.

Fits '86-'99 FLSTC, '90-'17 FLS, FLSS, FLSTF, FLSTFB and FLSTFBS, '06 FLST and '93-'96 FLSTN models without auxiliary lamps. Does not fit Springer™ models.

58243-95 21" Clear – Polished Braces. **\$411.95**
Windshield dimensions: Overall height – 26.3"; width – 23.1".

58278-95 18" Light Smoke – Polished Braces. **\$411.95**
Windshield dimensions: Overall height – 23.4"; width – 23.1".

Fits '00-'17 FLS, FLSS, FLST, FLSTC, FLSTF, FLSTFB and FLSTFBS models equipped with auxiliary lighting. Does not fit with Custom Auxiliary Lighting Kit P/N 68000051. Includes mounting hardware.

57400114 23" Clear – Polished Braces. **\$416.95**
Windshield dimensions: Overall height – 28.3"; width – 23.1".

57400112 21" Clear – Polished Braces. **\$410.95**
Windshield dimensions: Overall height – 26.3"; width – 23.1".

57400115 18" Clear – Polished Braces. **\$393.95**
Windshield dimensions: Overall height – 23.4"; width – 23.1".

Fits '00-'17 FLS, FLSS, FLST, FLSTC, FLSTF, FLSTFB and FLSTFBS models equipped with auxiliary lighting. '00-'17 FLS, FLSS, FLST, FLSTF, FLSTFB and FLSTFBS models require separate purchase of Docking Hardware Kit P/N 91800025. Does not fit with Custom Auxiliary Lighting Kit P/N 68000051.

57061-09 18" Clear – Polished Braces. **\$363.95**
Windshield dimensions: Overall height – 23.4"; width – 23.1".

Fits '86-'99 FLSTC, '90-'99 FLSTF and FLSTFB and '93-'96 FLSTN models with auxiliary lighting. Includes mounting hardware. Does not fit Springer models.

58240-95 21" Clear – Polished Braces. **\$390.95**
Windshield dimensions: Overall height – 26.3"; width – 23.1".

F. KING-SIZE H-D DETACHABLES WINDSHIELD FOR FL SOFTAIL MODELS – BLACK BRACES

Designed to be installed or removed without tools in seconds, a detachable windshield gives you the freedom to define your ride at the drop of a hat. Ride across the country protected from the elements, then quickly remove the windshield to hit the streets in style. This one-piece windshield is formed from hard-coated polycarbonate material to resist scratching. The shield is attached to stainless steel mounting brackets supported by molded-rubber bushings for improved isolation. Windshields are available with contemporary gloss black braces and mounting brackets and in a variety of heights to match your size and riding style.

Fits '00-'17 FLS, FLSS, FLST, FLSTC, FLSTF, FLSTFB and FLSTFBS models equipped with auxiliary lighting. Does not fit with Custom Auxiliary Lighting Kit P/N 68000051. Includes mounting hardware.

57400110 21" Clear – Black Braces. **\$427.95**
Windshield dimensions: Overall height – 26.3"; width – 23.1".

57400111 18" Light Smoke – Black Braces. **\$440.95**
Windshield dimensions: Overall height – 23.4"; width – 23.1".

Fits '86-'99 FLSTC, '90-'17 FLS, FLSS, FLSTF, FLSTFB and FLSTFBS, '06 FLST and '93-'96 FLSTN models without auxiliary lamps. Does not fit Springer models.

57688-10 21" Clear – Black Braces. **\$440.95**
Windshield dimensions: Overall height – 26.3"; width – 23.1".



E. KING-SIZE H-D DETACHABLES WINDSHIELD FOR FL SOFTAIL MODELS – POLISHED BRACES



F. KING-SIZE H-D DETACHABLES WINDSHIELD FOR FL SOFTAIL MODELS – BLACK BRACES

Notice: The prices appearing in this catalog are the manufacturer's suggested retail prices. Actual retail prices may vary.

Notice: The prices appearing in this catalog are the manufacturer's suggested retail prices. Actual retail prices may vary.

152 CRUISER

Windshields – FL Softail®

A. KING-SIZE NOSTALGIC H-D® DETACHABLES™ WINDSHIELD FOR FL SOFTAIL® MODELS

Formed from hard-coated polycarbonate to resist scratching, this one-piece windshield features a nostalgic horseshoe-shaped outer brace with stylized Bar & Shield logo. The highly polished mounting brackets attach easily with the included mounting hardware and after initial installation, the windshield can be removed and re-attached without tools in seconds. H-D® Detachables™ Windshields are available in 21" and 18" versions to match your need for wind protection.

Fits '05-'17 FLS, FLSS and FLSTN, '86-'17 FLSTC, '00-'17 FLSTF, FLSTFB, FLSTFBS, and '06 FLST models with or without auxiliary lamps. Does not fit with Custom Auxiliary Lighting Kit P/N 68000051. Additional mounting hardware not required.

57140-05 21" Clear. **\$434.95**
Windshield dimensions: Overall height – 26.3"; width – 23.1".
57141-05 18" Light Smoke. **\$445.95**
Windshield dimensions: Overall height – 23.4"; width – 23.1".



A. KING-SIZE NOSTALGIC H-D DETACHABLES WINDSHIELD FOR FL SOFTAIL MODELS

B. WIND SPLITTER VENTED WINDSHIELD

Reduce helmet buffeting at speed. The Harley-Davidson® Detachables™ Wind Splitter Vented Windshield features an exclusive fingertip-adjustable center vent that reduces turbulence behind the windscreen. When open, the controlled airflow fills the negative pressure area behind the shield and helps to smooth the flow of air over the top of the screen and around the rider. The revised flow reduces helmet bobbing and neck fatigue so you can comfortably spend more time in the saddle. The open vent also provides cooling airflow to the rider at low speeds and in city traffic.

57400159 **\$466.95**
Fits '00-'17 FLSTC and FLS, FLSS, FLST, FLSTF, FLSTFB, FLSTFBS and FLSTN models equipped with auxiliary lighting. Does not fit with Custom Auxiliary Lighting Kit P/N 68000051 or with Mini Tach or Boom!™ Audio Cruiser Speakers. Windshields dimensions: Overall height – 22.4", height from headlamp opening – 16.1", width – 20.3".



B. WIND SPLITTER VENTED WINDSHIELD

C. KING-SIZE H-D® DETACHABLES™ WINDSHIELD FOR HERITAGE SPRINGER™ MODELS

This one-piece windshield is formed from hard-coated polycarbonate material to resist scratching. The shield is attached to highly polished stainless steel mounting brackets supported by molded-rubber bushings for improved isolation.

58772-97 18" Clear. **\$375.95**
Fits '97-'03 FLSTS and '05-'07 FLSTSC models. Installation requires the separate purchase of Windshield Docking Hardware Kit P/N 58907-96B. Will not fit with Chrome Billet Mini Tach Mounts. Windshield dimensions: Overall height – 27.0"; width – 23.1".



C. KING-SIZE H-D DETACHABLES WINDSHIELD FOR HERITAGE SPRINGER MODELS – 18" CLEAR



D. FORK-MOUNT WIND DEFLECTORS – CHROME



E. REPLACEMENT WINDSHIELD SCREEN



F. WINDSHIELD ACORN NUT KIT



G. MID-FRAME AIR DEFLECTOR



G. MID-FRAME AIR DEFLECTOR

CRUISER 153

Windshield Accessories

D. FORK-MOUNT WIND DEFLECTORS – CHROME

Dress your bike for comfort and style. Wind Deflectors extend the windshield's coverage for superior protection in any weather. The scooped Deflectors are shaped to channel the airflow and direct the rush of air and turbulence around the rider. Deflectors attach to the fork brackets for a clean, integrated look and the chrome finish is the perfect complement to polished or chrome front end components. Easy-to-install kit includes all required mounting hardware.

57400143 **\$116.95**
Fits '86-'17 FLS, FLSS, FLST, FLSTC, FLSTF, FLSTFB and FLSTFBS, '93-'96 FLSTN and '10-'12 FLSTSE models equipped with Harley-Davidson® King-Size Windshield and/or Passing Lamp Kits. Does not fit Springer™ models.

E. REPLACEMENT WINDSHIELD SCREEN

Tailor your existing windshield for your riding preference. Replace the original windshield with a screen sized to improve wind protection. Uses your existing mounting brackets and hardware for an easy, economical conversion.

Fits '86-'17 FLS, FLSS, FLSTC, FLSTF, FLSTFB and FLSTFBS, '06 FLST and '93-'96 FLSTN equipped with a H-D™ Detachables™ King-Size Windshield. Does not fit Springer models.

57754-04 23" Clear. **\$173.95**
57975-99 21" Light Smoke. **\$184.95**
58277-95 18" Light Smoke. **\$173.95**

F. WINDSHIELD ACORN NUT KIT

Kit contains 10 chrome-plated low crown 12-24 acorn nuts.
94111-95 **\$11.95**
Fits Compact, King-Size, Convertible and Road King® windshields. (Pkg. of 10.)

G. MID-FRAME AIR DEFLECTOR

Improve rider comfort during the summer riding season. Designed for severe duty and extreme temperature applications, these inconspicuous black deflectors attach to the frame and surround the top of the rear cylinder head. The scoop shape captures the moving air and uses the flow to direct the heat down and away from the rider to improve comfort. Kit includes all required mounting hardware.

29200008A **\$106.95**
Fits '08-'17 Softail® models (except FXCW, FXCWC, FXSB, FXSBSE and FXSE).

Notice: The prices appearing in this catalog are the manufacturer's suggested retail prices. Actual retail prices may vary.

Notice: The prices appearing in this catalog are the manufacturer's suggested retail prices. Actual retail prices may vary.

154 CRUISER

Seating

A. SUPER REACH® SOLO SEAT

Get a little bit closer. Super Reach® forward position seats are designed to move riders with a shorter inseam even closer to the controls and to bring the legs about 1.0" closer together so that your feet rest firmly on the pavement. The scooped bucket-shape saddle is enhanced with added back support padding to move the rider up to 1.0" lower and 2.5" forward. The combination positions the rider closer to the hand and foot controls to offer both comfort and confidence. For a two-up ride, combine the solo seat with the Touring Passenger Pillion P/N 51898-05A (sold separately).

54380-11 **\$276.95**
Fits '07-'17 FLSTC, '05-'17 FLSTN, FLSTNSE, and '05-'10 FLST and FLSTSC models. Seat width 12.0".



A. SUPER REACH SOLO SEAT

B. REACH SEAT

Designed specifically for riders requiring a close to the bar riding position, this seat positions the rider approximately 1.0" forward and the narrow front profile brings your legs closer together to help you plant your feet firmly on the ground. The seat features a textured vinyl insert and a Bar & Shield logo that shows you are riding in style.

51470-06A **\$398.95**
Fits '07-'17 FLSTF, FLSTFB, FLSTFBS, FLSTSB and '06-'15 FXST, FXSTB, FXSTC, FXSTS and '07-'08 FXSTSSE models. Does not fit FLSTSE models. FLSTSB models require separate purchase of Passenger Footpeg Mounting Kit P/N 50932-08 and passenger footpegs. Seat width 13.5"; passenger pillion width 10.0".



B. REACH SEAT

SUNDOWNER™ SEATS

The Sundowner™ Seat provides the maximum in long-riding comfort. The deep-bucket design puts your body in the proper touring position and the generous padding makes it comfortable for both the rider and passenger as the miles are adding up. The dish shape provides added rider back support and the wide passenger pillion is shaped to minimize pressure points.

C. SUNDOWNER SEAT – SMOOTH

The smooth vinyl cover features elegant top-stitching to complement most Harley-Davidson® saddlebags and luggage.

51468-06A **\$398.95**
Fits '07-'17 FLSTF, FLSTFB, FLSTFBS, FLSTSB, and '06-'15 FXST, FXSTB, FXSTC, FXSTS and '07-'08 FXSTSSE models. Does not fit FLSTSE models. FLSTSB models require separate purchase of Passenger Footpeg Mounting Kit P/N 50932-08 and passenger footpegs. Seat width 16.5"; passenger pillion width 12.5".

51764-06 **\$382.95**
Fits '00-'17 FLST, FLSTC, FLSTNSE, FLSTSC, '00-'06 FLSTF and '00-'05 FX Softail® models (except FXSTD). Also fits FLSTN models with removal of stock luggage rack. Seat width 16.5"; passenger pillion width 12.5".



C. SUNDOWNER SEAT – SMOOTH (51468-06A SHOWN)

D. SUNDOWNER SEAT – BLACKLINE™ & SOFTAIL SLIM® MODELS

The smooth vinyl cover features elegant top-stitching to complement most Harley-Davidson® saddlebags and luggage.

52000011 **\$382.95**
Fits '11-'17 FLS, FLSS and '11-'13 FXS models. Installation requires separate purchase of Passenger Footpeg Mounting Kit P/N 50932-08 and passenger footpegs. Seat width 15.5"; passenger pillion width 12.0".



D. SUNDOWNER SEAT – BLACKLINE & SLIM



Reach Seats

Notice: The prices appearing in this catalog are the manufacturer's suggested retail prices. Actual retail prices may vary.

CRUISER 155

Seating

E. SIGNATURE SERIES® SEAT WITH RIDER BACKREST

A perfect combination of foam density and shape has created our most comfortable seat for long-haul touring. Both rider and passenger will be extra comfy riding to Sturgis and back with the wide seating areas. When you reach your destination, city driving will be easier with the narrow nose that helps keep your legs together. Seat features an easily removable adjustable rider backrest that folds down for easier passenger mounting. Rider backrest has a 5-position height adjustment with 1.5" range and a wide range of forward/back angle adjustment with a quick twist of the control knob.

51985-08 **\$584.95**
Smooth.
Fits '07-'17 FLSTF, FLSTFB, FLSTFBS, FLSTSB, and '06-'15 FXST, FXSTB, FXSTC, FXSTS and '07-'08 FXSTSSE models. Does not fit FLSTSE models. FLSTSB models require separate purchase of Passenger Footpeg Mounting Kit P/N 50932-08 and passenger footpegs. Seat width 16.0"; passenger pillion width 14.0".

F. BADLANDER® SEAT

Clean smooth covers, subtle top-stitching and a frame-hugging profile add up to a statement only Harley could create. The low design delivers a reduced seat height that is ideal for riders who want the shortest possible reach to the ground, and the long and lean shape allows tall riders to move back from the hand and foot controls without sitting higher on the bike. Kit includes grab strap and all mounting hardware.

51397-06A **\$319.95**
Fits '07-'17 FLSTF, FLSTFB, FLSTFBS and FLSTSB, '06-'15 FXST, FXSTB, FXSTC, FXSTS and '07-'08 FXSTSSE models. Does not fit FLSTSE models. FLSTSB models require separate purchase of Passenger Footpeg Mounting Kit P/N 50932-08 and passenger footpegs. Seat width 12.0"; passenger pillion width 6.5".

52292-00A **\$319.95**
Fits '00-'17 FLST, FLSTC, FLSTNSE, FLSTSC, '00-'06 FLSTF and '00-'05 FX Softail® models (except FXSTD). Also fits FLSTN models with removal of stock luggage rack. Seat features embroidered Harley-Davidson script logo. Seat width 12.0"; passenger pillion width 6.5".



E. SIGNATURE SERIES SEAT WITH RIDER BACKREST – SMOOTH



E. SIGNATURE SERIES SEAT WITH RIDER BACKREST - INSTALLED



E. SIGNATURE SERIES SEAT WITH RIDER BACKREST - REMOVED



F. BADLANDER SEAT (51397-06A SHOWN)

NOTE: Some Harley-Davidson® seats are made of leather. Fine leathers or other natural materials WILL gain "character," such as wrinkles or wear, with age. This is normal. A fine, aged patina and character wrinkles are a sign of the extremely high-quality materials used to construct your seat or backrest. The appearance of scars or marks on the leather are a result of using natural leather panels and should not be thought of as an imperfection. Please use Harley-Davidson® Leather Protectant P/N 93600034 to protect your investment.

Notice: The prices appearing in this catalog are the manufacturer's suggested retail prices. Actual retail prices may vary.

SOFTAIL

156 CRUISER

Seating – Pillion

A. TOURING PASSENGER PILLIONS*

Styled to match the stitching and texture of the Original Equipment rider seat, these stylish pillions provide an extra comfortable ride for your passenger on those long journeys.

52915-07 '07-'11 Fat Boy® Models Styling. **\$201.95**
Fits '05-'07 FLST, and '07-'17 FLSTC, FLSTF, FLSTFB and FLSTFBS and FLSTSC models. Pillion width 14.0".

52930-05 Softail® Deluxe Models Styling. **\$201.95**
Fits '05-'17 FLSTN models with Original Equipment Solo Seat. Pillion width 12.0".

51763-07 Heritage Softail® Classic Models Styling. **\$201.95**
Fits '05-'07 FLST, and '07-'17 FLSTC, FLSTF, FLSTFB and FLSTFBS and FLSTSC models. Pillion width 14.0".

52912-00 Heritage Softail Classic Styling. **\$201.95**
Fits '84-'06 Softail® models (except '05 FLSTFI 15th Anniversary models, FLSTN, FLSTS, FLSTSC or FXSTD). Pillion width 14.0".



A. TOURING PASSENGER PILLION – FAT BOY STYLING

B. PASSENGER PILLION – SOFTAIL SLIM® MODEL STYLING*

Bring a passenger along for the ride. This easy-to-install detachable Passenger Pillion features a tuck and roll cover styled to match the Original Equipment Softail Slim® solo seat. Kit includes mounting hardware and grab strap.

52400039 **\$170.95**
Fits '12-'17 FLS and FLSS models equipped with Original Equipment solo seat. Installation requires separate purchase of Passenger Footpeg Mounting Kit P/N 50932-08 and passenger footpegs. Also fits '11-'13 FXS models equipped with Tuck & Roll Solo Seat P/N 52000031. Pillion width 6.5".



A. TOURING PASSENGER PILLION – SOFTAIL DELUXE STYLING



A. TOURING PASSENGER PILLION – HERITAGE SOFTAIL CLASSIC STYLING



B. PASSENGER PILLION – SOFTAIL SLIM STYLING



***WARNING:** Do not install on models that are not equipped with passenger footpegs. Doing so could result in death or serious injury.

Notice: The prices appearing in this catalog are the manufacturer's suggested retail prices. Actual retail prices may vary.

CRUISER 157

Seating – Spring Seats

C. BOBBER SOLO SADDLE

The thick distressed black leather cover is bonded directly to the formed metal seat pan and minimizes the foam filler and the extra height it brings. The raw-edge leather pad is joined to the pan with brass rivets, and features matching brass "Milwaukee Since 1903" trim that will develop a rich patina with use. The Bar & Shield logo is embossed into the leather surface as a finishing touch. Easy to install, the bolt-on seat and a model-specific installation kit includes everything you need to get the bobber look. No cutting, welding or fabrication is necessary.

52000277 Distressed Black Leather. **\$319.95**
Fits '04-'06 and '10-'22 XL, '06-'17 Dyna® and '08-'17 FLS, FLSS, FLSTC, FLSTN and FXS models. Installation requires separate purchase of model-specific Rigid or Spring Seat Mounting Hardware Kit. Seat width 10.5".



C. BOBBER SOLO SADDLE (SHOWN WITH SPRING SADDLE INSTALLATION KIT)

D. SOLO SADDLE

Available in elegant leather, this solo seat features a low-profile design that provides the minimalistic just enough to ride look. The smooth metal seat pan and the simple frame cover leave a clean, finished appearance. Easy to install, the bolt-on seat and model-specific Spring Seat Installation Kit include everything you need to get the bobber look. No cutting, welding or fabrication is necessary and the seat can be removed and replaced with a touring seat for a two-up night on the town.

Fits '04-'06 and '10-'22 XL, '06-'17 Dyna and '08-'17 FLS, FLSS, FLSTC, FLSTN and FXS models. Installation requires separate purchase of model-specific Rigid or Spring Seat Mounting Hardware Kit. Seat width 10.5".

52000276 Black Diamond. **\$319.95**

Also available:

SPRING SADDLE INSTALLATION KIT

The torsion-style springs are designed for the optimum balance between spring suspension and support. Required for installation of Solo Saddle Kit P/N 52000277, 52000279, 52000278, 52000275, 52000276, 52000180, 54072-10, 54373-10, 52000114 and 52000113. Kit includes springs, mounting brackets, frame cover and hardware.

54376-10B **\$304.95**
Fits '08-'17 FLSTC and FLSTN models.

E. STANDARD LEATHER SOLO SPRING SADDLE

First offered in 1925, this timeless solo saddle offers a deep dish bucket shape and a firm leather covering. Installation requires separate purchase of model-specific Seat Bracket and Spring Kit.

52004-25 **\$327.95**
Fits '08-'15 FLSTSB, FXST, FXSTB, FXSTC and FXSTS and '86-'94 Softail® models. Does not fit '07-'09 FXSTSSE. Requires separate purchase of model-specific Mounting Hardware Kit P/N 51902-09 or 52225-89.

Also available:

SOLO SEAT BRACKET/SPRING KIT

This kit is required to install Touring Solo Saddle P/N 51481-08, Deluxe Leather Solo Saddle P/N 52006-47B or Leather Solo Saddle P/N 52004-25.

51902-09 **\$263.95**
Fits '08-'15 FLSTSB, FXST, FXSTB and FXSTC models.



D. SOLO SADDLE – BLACK DIAMOND (SHOWN WITH SPRING SADDLE INSTALLATION KIT)



E. STANDARD LEATHER SOLO SPRING SADDLE

Notice: The prices appearing in this catalog are the manufacturer's suggested retail prices. Actual retail prices may vary.

SOFTAIL

158 CRUISER

Seating Accessories

A. ROAD ZEPPELIN® SEAT PAD

Experience ultimate comfort. Designed to ensure hours of comfort in the saddle, Road Zeppelin® Seat Pads are equipped with a unique air bladder system that allows your weight to be supported evenly across the entire seating surface. Whether you have a low-profile seat or a larger more comfortable seat, you will feel the benefits. This air bladder system is designed to reduce pressure points, provide shock absorption and reduce vibration. Unlike other mouth-inflated seat pads, the Road Zeppelin Pad features an easy-to-reach integrated hand pump and metered air release valve that permits quick and controllable adjustment. You can easily adjust the comfort and support while seated on the pad. The UV-stable and snag-resistant mesh cover allows air to circulate beneath the rider's body, reducing the temperature trapped between the rider and seat. Shaped to conform to most Harley-Davidson® seats, the pads feature adjustable mounting straps and a non-skid surface to keep them in place. The hand-washable seat pad can be deflated and rolled for compact storage.

52000327 Rider. **\$180.95**

Fits rider position on all models equipped with Original Equipment or accessory seats. Also fits passenger position on Touring models with large pillion area. Pad width – 14.0".

52400162 Passenger. **\$168.95**

Fits Original Equipment and accessory passenger pillions. Pad length – 12.0"; width – 9.0".



A. ROAD ZEPPELIN SEAT PAD

B. CIRCULATOR SEAT AND BACKREST PADS

Keep comfortable on your next long ride. These breathable Circulator Pads feature 3D construction that promotes air movement and reduces heat buildup where the rider's body touches the seat or backrest. Designed to keep the rider cool by reducing the perspiration buildup between you and the seating surface, the Circulator Pad can be installed and removed in seconds for easy cleaning. The low-profile design minimizes seat-height change compared to inflatable pads, while enhancing comfort with its shock-absorbing construction. Manufactured of UV-stable materials, these seat pads resist fading when exposed to the sun. Elastic under-seat strap and non-slip base provide secure installation and the available Circulator Passenger Pillion Pad attaches to the rider pad with hook-and-loop tabs.

51076-10 Large Seat Pad. **\$107.95**

Fits Softail®, Touring and Trike models with Original Equipment and accessory seats. Will not fit Bobber or Road Zeppelin seats. Pad width – 16.0".

51078-10 Passenger Pillion Pad. **\$74.95**

Fits Original Equipment and accessory passenger pillions. Pad width – 13.0".

52300103 Wide Backrest Pad. **\$64.95**

Fits wide profile rider and passenger backrest pads up to 12.0" wide and 9.0" tall.



B. CIRCULATOR SEAT AND WIDE BACKREST PADS

C. RAIN COVERS*

Featuring a handy storage sack, this black nylon, water-resistant, Cordura® cover packs easily and shelters your seat from the storm.

51638-97 Solo Seat. **\$33.95**
Fits H-D® solo seats (except XR and FLSTS).

51639-97 Two-Up. **\$35.95**
Fits VRSC™, XG, XL, Dyna® and Softail models with Two-Up seats. Does not fit Touring and Trike models. Does not fit with Rider Backrests.



C. RAIN COVER – SOLO SEAT



C. RAIN COVER – TWO-UP SEAT



***WARNING:** Do not use while riding; could result in death or serious injury.

Notice: The prices appearing in this catalog are the manufacturer's suggested retail prices. Actual retail prices may vary.

CRUISER 159

Seating Accessories

D. TANK KNEE PAD KIT

These self-adhesive rubber knee pads provide a touch of old school style. The rich black rubber pads feature tapered ribs and a raised Bar & Shield logo to protect the surfaces where your legs contact the tank. The compact pads measure 7.0" by 2.75", and are flexible enough to fit many tank profiles. Sold in matched pairs.

57300065 **\$43.95**

Fits fuel tanks on many Harley-Davidson Street®, Sportster®, Dyna® and Softail® models. May cover a portion of fuel tank graphics. Check placement before adhering to tank.



D. TANK KNEE PAD KIT

E. QUICK-RELEASE SEAT HARDWARE KIT

This Quick-Release Hardware Kit allows the rider to remove one-piece Harley-Davidson® seats quickly and easily. The knurled knob is easy to install or remove without tools, and the nylon washer keeps the finger tightened knob in place and rattle free. A raised-logo Harley-Davidson emblem finishes the look. SAE 1/4"-20 thread.

Fits '97-later XG, XL, Dyna, Softail (except '12-'17 FLS models equipped with Original Equipment seat), Touring and Trike models equipped with SAE 1/4"-20 seat mount hardware. Does not fit seats equipped with spring-loaded rear seat bracket.

51676-97A Chrome. **\$23.95**

10500093 Gloss Black. **\$23.95**



E. QUICK-RELEASE SEAT HARDWARE KIT – CHROME

F. SEAT MOUNTING NUTS – GLOSS BLACK

When blacking-out your bike, don't miss the details. These gloss black Seat Mounting Nuts take the hassle out of removing your two-piece seat and complete the blacked out look. These rich black caps dress up the seat mounting tab and the knurled knob makes fastening and unfastening the seat easy work. No tools required. Sold in pairs.

10400049 **\$28.95**

Fits all Softail and Touring models with Original Equipment or Genuine Motor Accessory 2-piece seat and knurled seat mounting nuts.

G. CHROME SCREWS FOR FLST SEAT BRACKET

94289-94T **\$11.95**

Fits '87-'99 FLSTC, FLSTF and FLSTN models.

H. BILLET SEAT MOUNTING BRACKET – CHROME

The highly stylized design of this bracket adds a stunning look to the back of most seats.

51804-02 **\$27.95**

Replaces Bolt-On Seat Brackets P/N 51798-00, 51740-10, 52467-00, 51652-97A and 51652-83B used on most Original Equipment and accessory seats and pillions.



E. QUICK-RELEASE SEAT HARDWARE KIT – GLOSS BLACK



F. SEAT MOUNTING NUTS – GLOSS BLACK



G. CHROME SCREWS FOR FLST SEAT BRACKET



H. BILLET SEAT MOUNTING BRACKET – CHROME

Notice: The prices appearing in this catalog are the manufacturer's suggested retail prices. Actual retail prices may vary.

BUILDING A BACKREST

A sissy bar upright and passenger backrest are the starting point to build a complete touring machine. The backrest provides long-range comfort and support and adds a feeling of control and confidence for the passenger. Start by selecting model-specific Docking Hardware, then choose a finish that matches your styling direction, determine the desired sissy bar height and finally select a backrest pad that complements your seat.

DOCKING HARDWARE



SHORT & TALL UPRIGHT



SIDE PLATES



PASSENGER BACKREST PAD



SELECT THE DOCKING HARDWARE

2000-later Softail® Docking Hardware for H-D® Detachables™ Racks, Tour-Pak® Racks & Sideplates
Docking hardware fitment is dependent on vehicle model and saddlebag configuration.

H-D Detachables Accessory

Available to fit:

	Docking Hardware	Directional Relocation Kit
No Saddlebags Detachable Sideplates 53810-00C (Chrome), 53857-00B (Wrinkle Black), 54258-10A (Gloss Black), Solo Detach Rack 53649-05A (Chrome), 53612-08, 53652-05 (Black), One-Piece Detach Sissy Bar Upright P/N 53618-05 (Chrome), 52729-08 (Black), FXS One-Piece Sissy Bar P/N 52828-11, 52760-11. Solo Detach Tour-Pak® Rack 53559-04B or Two-Up Detachable Tour-Pak Rack 54051-08A, 53066-00D.	2003-2017 FXST, FXSTB, FXSTS, FXSTSE, FXSTC, FLSTF, FLSTFB, FLSTFBS, FLSTSB, 2006 FLSTFSE	53932-03A \$54.95 53959-06 Chrome \$54.95 54268-10 Black \$54.95
	2005-2017 FLSTN, FLST	53932-03A \$54.95 Not Required
	2005-2007 FLSTSC	53932-03A \$54.95 53959-06 Chrome \$54.95 54268-10 Black \$54.95
	2011-2017 FLS, FLSS, FXS	53932-03A \$54.95 54296-11 \$54.95
	2013-2017 FXSB, FXSBSE, 2016-later FXSE	52300239 \$55.95 Not Required
With P&A Saddlebags Detachable Sideplates 53810-00C (Chrome), 53857-00B (Wrinkle Black), 54258-10A (Gloss Black), Solo Detach Rack 53649-05A (Chrome), 53612-08, 53652-05 (Black), One-Piece Detach Sissy Bar Upright P/N 53618-05 (Chrome), 52729-08 (Black), Solo Detach Tour-Pak Rack 53559-04B, Two-Up Detachable Tour-Pak Rack 54051-08A, 53066-00D.	2006 FLSTFSE, 2003-2017 FLSTF, FLSTFB, FLSTFBS, FLSTSB, FXST, FXSTB, FXSTC, FXSTS, 2007-2008 FXSTSE	53930-03B \$55.95 53959-06 Chrome \$54.95 54268-10 Black \$54.95
	2005-2017 FLST, FLSTN	53930-03B \$55.95 Not Required
	2005-2007 FLSTSC	53930-03B \$55.95 53959-06 Chrome \$54.95 54268-10 Black \$54.95
With P&A Saddlebags 53015-05, 53061-00A, 88237-07, 88238-07, 88263-07, 88286-07, 90058-05, 90114-00A, 90119-00A, 90130-00B, 90133-06B, 90200765, 90200816, 90201389, 90320-00B, 90384-04, 90384-06, 90388-04, 90419-08, 91536-00A, 91537-00A, 91555-01A, 92000-00B and 92015-03.	2003-2017 FLSTC	53931-03A \$54.95 Not Required
	2003 FLSTS	53931-03A \$54.95 53959-06 Chrome \$54.95 54268-10 Black \$54.95
	2005-2007 FLSTSC	53931-03A \$54.95 53959-06 Chrome \$54.95 54268-10 Black \$54.95
	2006 FLST	53931-03A \$54.95 Not Required
Detachable Sideplates and Hard Saddlebags 90715-08XX.	2008-2017 FLSTF, FLSTFB, FLSTFBS	53930-03B & 53075-03 \$75.95 Included with Hard Saddlebags
	2008-2017 FLSTN	53930-03B & 53075-03 \$75.95 Not Required

*See fitment for Saddlebag Kits P/N 88237-07, 88238-07 or 88306-07. Notice: The prices appearing in this catalog are the manufacturer's suggested retail prices. Actual pricing may vary.



A. H-D DETACHABLES SIDEPLATES

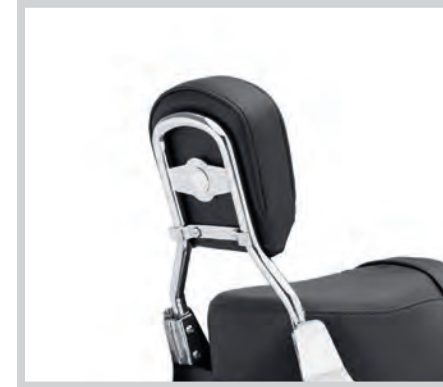

B. LOW SISSY BAR UPRIGHT – CHROME (52300022 SHOWN)



B. LOW SISSY BAR UPRIGHT – GLOSS BLACK (54256-10 SHOWN)



B. LOW SISSY BAR UPRIGHT – CHROME (52540-09A SHOWN)



B. LOW SISSY BAR UPRIGHT – GLOSS BLACK (52300401 SHOWN)



C. STANDARD SISSY BAR UPRIGHT – CHROME (52300018 SHOWN)



C. STANDARD SISSY BAR UPRIGHT – GLOSS BLACK (52300020 SHOWN)

A. H-D® DETACHABLES™ SIDEPLATES

In the time it takes for a traffic light to change, you can transform your motorcycle from a city cruiser to a cross-country hauler. Start with Harley-Davidson® Detachables™ Sideplates, and add your choice of sissy bar upright and pad to make removing the passenger backrest a simple slide and click operation. Manufactured and tested to rigorous Harley-Davidson standards, installation requires separate purchase of model-specific Docking Hardware Kit.

Fits '00-'17 FLST, FLSTF, FLSTFB, FLSTFBS, FLSTN, FLSTNSE, FLSTSB, FLSTSC, FLSTSE, FXSB, FXSBSE, FXST, FXSTB, FXSTS, FXSTSE and '06 FLSTFSE models with or without saddlebags (except Heritage Softail® Saddlebags P/N 90876-05). Requires separate purchase of Docking Hardware Kit and may require Directional Relocation Kit. See chart for your application.

53810-00C	Chrome.	\$160.95
54258-10A	Gloss Black.	\$160.95

Fits '00-'17 FLSTC and '00-'03 FLSTS models. Also fits '05-'15 FLST and FLSTSC models with Heritage Saddlebag P/N 90876-05. Requires separate purchase of Docking Hardware Kit and may require Directional Relocation Kit. See chart for your application.

53815-00A	Chrome.	\$155.95
------------------	---------	-----------------

SISSY BAR UPRIGHTS

Sissy Bar Uprights are available in a variety of shapes and styles. Round bar uprights feature a mini medallion bar and an embossed Bar & Shield insert. Uprights are designed to accept specific 3-bolt or 2-bolt mounted backrest pads.

B. LOW SISSY BAR UPRIGHT

Shaped to complement a thicker passenger pillion, the ideal match for touring style seats, this upright also offers additional height options to riders with custom style seats.

Fits '04-'22 XL models with H-D® Detachables™ sideplates, '06-'17 Dyna® (except FXDF, FXDFSE and '10-'17 FXDWG), '84-'05 Softail® (except FXSTD) and '06-'17 FL Softail models (except '07-'17 FLS, FLSS, FLSTF, FLSTFB, FLSTFBS, FLSTSE and FLSTSB and '06 FLSTFSE) with appropriate sideplates.

52300022	Chrome.	\$119.95
-----------------	---------	-----------------

Fits '07-'17 FLSTF, FLSTFB, FLSTFBS, FLSTSB, FLSTSE and FXSTC, '06 FLSTFSE, '06-'17 FXST, FXSTB and FXSTS and '07-'08 FXSTSE models with appropriate sideplates. '07-'10 FXSTC models require separate purchase of Fender Mounted Seat.

51477-06	Chrome.	\$116.95
54256-10	Gloss Black.	\$116.95

Fits '13-'17 FXSB and FXSBSE, '16-'17 FXSE and '09 FXSTSE models with appropriate H-D Detachables sideplates. FXSTSE models require separate purchase of Hardware Kit P/N 52300306.

52540-09A	Chrome.	\$116.95
52300401	Gloss Black.	\$116.95

C. STANDARD SISSY BAR UPRIGHT

Give your passenger additional back support with a Standard Sissy Bar Upright designed to accept a wide variety of backrest pads.

Fits '04-'22 XL models with H-D Detachables sideplates, '06-'17 Dyna (except FXDF, FXDFSE and '10-'17 FXDWG), '84-'05 Softail (except FXSTD) and '06-'17 FL Softail models (except '07-'17 FLS, FLSS, FLSTF, FLSTFB, FLSTFBS, FLSTSE and FLSTSB and '06 FLSTFSE) with appropriate sideplates.

52300018	Chrome.	\$116.95
52300020	Gloss Black.	\$116.95

Notice: The prices appearing in this catalog are the manufacturer's suggested retail prices. Actual retail prices may vary.

SOFTAIL

162 CRUISER

Backrests & Racks

A. ONE-PIECE H-D® DETACHABLES™ TALL SISSY BAR UPRIGHT – GLOSS BLACK

The sweeping shape and gloss black finish of this slim, round bar Sissy Bar Upright complements the classic bobber look of the Softail® Cross Bones™ model. The one-piece design eliminates separate sideplates for a clean appearance and the stylized upper kick angle mimics the old-school sissy bars of the '50s and '60s. Can be used with Passenger Backrest Pad P/N 52631-07.

52729-08A **\$232.95**

Fits '07-'17 FLSTF, FLSTFB, FLSTFBS, FLSTSB and FLSTSE and '06-'15 FXST, FXSTB, FXSTC and FXSTS models. Requires separate purchase of Docking Hardware Kit and may require Turn Signal Relocation Kit. See Docking Hardware Fitment Chart for your application.

Shown with:

PASSENGER BACKREST PAD

Styled to complement available touring and custom seats.

52631-07 **\$79.95**

Fits One-Piece H-D® Detachables™ Sissy Bar Upright P/N 52729-08A, 51853-07, 51849-07, 51146-10A, 51161-10A, 52300040A, 52300042A, 52300044A or 52300046A.

B. ONE-PIECE H-D DETACHABLES SISSY BAR – BLACKLINE® & SOFTAIL SLIM® MODELS

Sweeping curves and a sleek gloss black finish add a custom look to this detachable Sissy Bar. Featuring a slotted base and beefy solid bar upright, the one-piece design incorporates exclusive cam lock H-D Detachables hardware that allows you to install or remove the passenger backrest in seconds. Just add a backrest pad to complete the system.

52760-11 Standard-Height, Gloss Black. **\$283.95**

Fits '11-'17 FLS and FLSS and '11-'13 FXS models. Requires separate purchase of appropriate Docking Hardware P/N 53932-03A and Turn Signal Relocation Kit P/N 54296-11. Models equipped with Side-Mount License Plate require Relocation Kit P/N 67900127A. Models equipped with a center-mount license plate and fender-mounted reflectors require installation of additional components (sold separately): Red Reflector Kit P/N 67900223 or Amber Reflector Kit P/N 67900224.

Also available:

PASSENGER BACKREST PAD – SOFTAIL® BLACKLINE™ MODEL

Styled to complement the FXS Original Equipment or accessory seats, these compact Backrest Pads are the perfect match for Softail Blackline™ motorcycle.

52300038 Smooth. **\$79.95**

Fits '11-'17 FLS and FLSS and '11-'13 FXS models. Requires Fits '11-'17 FLS, FLSS and '11-'13 FXS models equipped with Sissy Bar P/N 52760-11 or 52828-11.



A. ONE-PIECE H-D DETACHABLES TALL SISSY BAR UPRIGHT – GLOSS BLACK (SHOWN WITH PASSENGER BACKREST PAD)



B. ONE-PIECE H-D DETACHABLES SISSY BAR – BLACKLINE & SLIM AND PASSENGER BACKREST PAD

CRUISER 163

Backrests & Racks

PASSENGER BACKREST PADS

Choose from a wide variety of backrest pad sizes and shapes to match your comfort and style demands. Designed to complement Original Equipment and accessory seats, these pads are engineered to fit specific sissy bar upright types.

C. BACKREST PADS

Sized to fit round bar sissy bar uprights, these pads mount to mini medallion-style uprights with two mounting holes.

Fits Nightster® standard and short uprights P/N's 52300702 and 52300700. Fits Standard Round Bar Mini-Medallion Style Upright P/N 52877-10 or 51168-10. Fits Low Round Bar Mini Medallion Style Sissy Bar Upright P/N 52300401, 52540-09A, 51477-06, 54256-10, 52300049 and 52300050.

1. 51641-06	Smooth Top-Stitched.	\$79.95
2. 51640-06	Smooth Bucket.	\$107.95
3. 51622-07	Fat Boy® Lacing Bucket.	\$129.95

D. BACKREST PADS

Sized to fit medallion and mini medallion-style sissy bar uprights. Pad mounts with single center screw and bolt-on mounting strap. Kit includes chrome-plated mounting hardware.

Fits Low Medallion Style Sissy Bar Upright P/N 52655-84, 52909-02, 52754-04, 51851-09, Standard Medallion Style Sissy Bar Upright P/N 52735-85 or 52877-08, Standard Square Bar Mini Medallion Style Sissy Bar Upright P/N 53281-06 or 53407-06, Standard Heritage Softail® Style Sissy Bar Upright P/N 52731-00 and Standard Round Bar Sissy Bar Upright P/N 52300018 or 52300020.

1. 52612-95	Smooth Top-Stitched.	\$79.95
2. 52412-79A	Embossed Bar & Shield Logo.	\$84.95
3. 52348-97	Heritage Classic Bucket.	\$118.95
4. 52347-97	Fat Boy® Bucket.	\$118.95
5. 51132-98	Smooth Bucket.	\$107.95

E. BACKREST PADS

Sized to fit medallion and mini medallion-style sissy bar uprights. Pad mounts with single center screw and bolt-on mounting strap. Includes chrome-plated mounting hardware.

Fits Low Medallion Style Sissy Bar Upright P/N 52754-04 or 51851-09, Low Square Bar Mini-Medallion Style Sissy Bar Upright P/N 53282-06, Standard Square Bar Mini Medallion Style Sissy Bar Upright P/N 53281-06 or 53407-06, Standard Medallion Style Sissy Bar Upright P/N 52735-85, 53007-98, 52655-84, 52909-02 or 51517-02, Standard Bar & Shield Style Sissy Bar Upright 52739-83 or 51514-02, Standard Heritage Style Sissy Bar Upright P/N 52731-00 and Low Round Bar Sissy Bar Upright P/N 52300022 or 52300024.

1. 52652-04	Smooth.	\$79.95
2. 52626-04	Smooth Top-Stitched.	\$79.95



C. BACKREST PADS



D. BACKREST PADS



E. BACKREST PADS

164 CRUISER

Backrests & Racks

A. AIR FOIL PREMIUM LUGGAGE RACK*

The low-profile aerodynamic styling defines the look of this Luggage Rack. Available in mirror chrome or rich gloss black finish, the die-cast rear "Air Foil" grabs your attention and the Bar & Shield insert adds a signature touch. The elegant round tube rack features inlaid rubber runners for added grip and dedicated bungee mounting points to simplify luggage tie-down. Kit includes all necessary mounting hardware. For added visibility, the rack is designed to incorporate the internal wiring of the Air Foil Rack LED Light Kit P/N 68000076 (red) for a clean look.

Fits '04-'22 XL models equipped with H-D® Detachables™ Sideplates, '06-'17 Dyna® models (except FXDF, FXDFSE and '10-'17 FXDWG) equipped with Detachable Sideplates, '84-'05 Softail® (except FLSTN and FXSTD) and '06-'17 FLST, FLSTC, FLSTNSE and FLSTSC and '06 FLSTF models equipped with Detachable Sideplates.

54290-11	Chrome.	\$230.95
54291-11	Gloss Black.	\$230.95

B. LED LIGHT KIT**

This fast-acting LED Light Kit operates as a supplemental rear running light and brake light. The high, center-mount position places the light in the line-of-sight of following vehicles and the bright, fast-acting LED lamps get you noticed. Wiring is concealed inside the rack tubes for a clean, custom installation. Available with red lens.

68000076 Red Lens. **\$54.95**
Fits Air Foil Luggage Rack P/N 54290-11, 54291-11 and Air Wing Sissy Bar Upright P/N 52300146 and 52300147. Installation requires separate purchase of model-specific Wiring Harness Kit.

Also available:

LED LIGHT KIT WIRING HARNESS

Required for installation of LED Light Kit on Air Foil Luggage Rack P/N 54290-11 or 54291-11.

73415-11 **\$14.95**
Fits '06-'17 Dyna (except FXDF, FXDFSE, '14-'17 FXDL, '16-'17 FXDLS and '10-'17 FXDWG), '84-'05 Softail (except FLSTN and FXSTD), '06-'17 FLST, FLSTC and FLSTSC and '06 FLSTF models with Air Foil Luggage LED Light Kit P/N 68000076 or 68000077.

C. CUSTOM TAPERED SPORT LUGGAGE RACK*

Smooth sweeping curves and the brilliant chrome or gloss black finish define the look of this Sport Luggage Rack. Designed to complement both round and square bar Sissy Bar Uprights, this sleek rack adds a practical and stylish touch to the motorcycle.

Fits '04-'22 XL models (except XL1200CX) equipped with H-D Detachables Sideplates, '06-'17 Dyna models (except FXDF, FXDFSE and '10-'17 FXDWG) equipped with Detachable Sideplates, '84-'05 Softail (except FLSTN and FXSTD) and '06-'17 FLST, FLSTC, FLSTNSE and FLSTSC and '06 FLSTF models equipped with Detachable Sideplates.

50300030	Chrome.	\$168.95
50300031	Gloss Black.	\$168.95

Fits '07-'17 FLSTF, FLSTFB, FLSTFBS, FLSTSB, FLSTSE and FXSTC, '06 FLSTFSE, '06-'15 FXST, FXSTB and FXSTS and '07-'08 FXSTSSE models with Detachable Sideplates and Sissy Bar Uprights. FXSTC models require separate purchase of Fender Mounted Seat.

53953-06	Chrome.	\$168.95
54263-10	Gloss Black.	\$168.95



***WARNING:** Do not use this rack as a seat. Do not exceed the fender rack weight capacity. Using as seat or exceeding this capacity could cause handling problems, which could result in loss of control and death or serious injury.



****WARNING:** Disconnecting your DOT-required tail, brake and turn signal lighting could reduce your visibility to others and result in death or serious injury.



A. AIR FOIL PREMIUM LUGGAGE RACK – CHROME



A. AIR FOIL PREMIUM LUGGAGE RACK – GLOSS BLACK



B. LED LIGHT KIT – AIR FOIL RACK



C. CUSTOM TAPERED SPORT LUGGAGE RACK – CHROME (53953-06 SHOWN)



C. CUSTOM TAPERED SPORT LUGGAGE RACK – GLOSS BLACK (54263-10 SHOWN)



D. H-D DETACHABLES SOLO RACK – GLOSS BLACK (50300099A SHOWN)



E. FIVE BAR SPORT LUGGAGE RACK – CHROME



F. LOCKING H-D DETACHABLES LATCH KIT – BLACK



G. H-D DETACHABLES LATCH KIT – CHROME

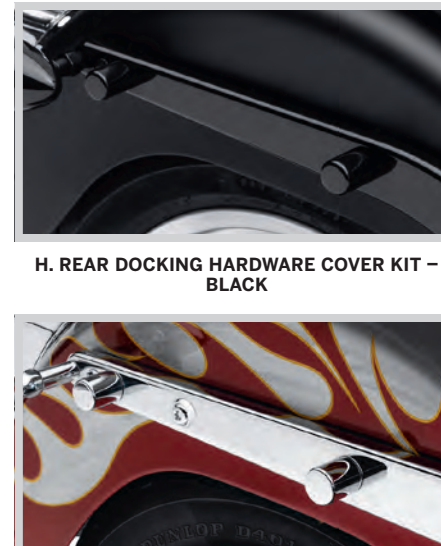

H. REAR DOCKING HARDWARE COVER KIT – BLACK

H. REAR DOCKING HARDWARE COVER KIT – CHROME

CRUISER 165

Backrests & Racks

D. H-D® DETACHABLES™ SOLO RACKS*

Add touring capabilities to your solo seat Softail® model in less than 60 seconds. This detachable Solo Rack fits over the fender when the passenger pillion is removed. The rack features brazed hand-polished tubing and the chrome or black finish adds a stylish flair. Requires Docking Hardware. Easily interchangeable with detachable Passenger Sissy Bar Upright and Sideplates.

50300099A Gloss Black. **\$221.95**
Fits '12-'17 FLS and FLSS and '11-'13 FXS models. Requires separate purchase of appropriate Docking Hardware P/N 53932-03A and Turn Signal Relocation Kit P/N 54296-11. Models equipped with Side-Mount License Plate require Relocation Kit P/N 67900127A. Models equipped with a center-mount license plate and fender-mounted reflectors require installation of additional components (sold separately): Red Reflector Kit P/N 67900223 or Amber Reflector Kit P/N 67900224.

E. FIVE BAR SPORT LUGGAGE RACK – CHROME*

This rack brings touring flexibility to your motorcycle. Can be used with H-D Detachables or Rigid Mount Sissy Bar Sideplates.

53862-00 **\$168.95**
Fits '04-'22 XL models (except XL1200CX) equipped with Detachable Sideplates, '06-'17 Dyna® models (except FXDF, FXDFSE and '10-'17 FXDWG) equipped with Detachable Sideplates, '84-'05 Softail® (except FLSTN and FXSTD), '06-'17 FLST, FLSTC and FLSTSC and '06 FLSTF models equipped with Detachable Sideplates. Does not fit with Round Bar Uprights P/N 52300018, 52300020, 52300022 and 52300024.

F. LOCKING H-D DETACHABLES LATCH KIT

This unique lock replaces the cam lock on your Harley-Davidson® Detachables™ accessories, providing additional security and peace of mind when parking your vehicle. The kit includes two extended-reach barrel-style keys for easy access to the lock. Key registration and replacement service is available. Sold in pairs.

Fits all models equipped with detachable Sideplates, Racks and Tour-Pak® Luggage Carriers (except '18-later Softail models with HoldFast™ racks and uprights or '09-later Touring models equipped with detachable Solo Tour-Pak Rack).

92800008 Black. **\$78.95**

G. H-D DETACHABLES LATCH KIT – CHROME

Decorative chrome latches are the perfect way to enhance the appearance of your detachable accessories. Meticulously polished and chrome-plated, these easy-to-install Rotary Latches are a direct replacement for the Original Equipment satin black parts and are a simple way to add a finishing touch to your ride. Latches feature an easy-to-pull finger release to simplify access in hard-to-reach areas.

12600036 **\$54.95**

Fits all models equipped with detachable Sideplates, One-Piece Sissy Bar Uprights, Racks, and Tour-Pak Luggage Mounting Racks (except '18-later Softail models with HoldFast racks and uprights).

H. REAR DOCKING HARDWARE COVER KIT

Disguise the rear docking hardware with these easy-to-install covers. The caps slide over the exposed docking points and are held in place by a strong magnetic pull. The caps are easy to remove when you wish to reinstall detachable accessories. Covers are available with brilliant chrome or durable gloss black finish to match your bike's attitude. Sold in pairs.

Fits many accessory docking hardware kits. Refer to the fitment matrix in this P&A Catalog Page 543 or the Parts & Accessories section of www.harley-davidson.com for details.

48218-10	Short Chrome (pair).	\$38.95
48220-10	Large Chrome (pair).	\$38.95
48035-09	Small Chrome (pair).	\$38.95
48221-10	Short Black (pair).	\$38.95
48223-10	Large Black (pair).	\$38.95
48225-10	Small Black (pair).	\$38.95



***WARNING:** Do not use this rack as a seat. Do not exceed the fender rack weight capacity. Using as seat or exceeding this capacity could cause handling problems, which could result in loss of control and death or serious injury.

Notice: The prices appearing in this catalog are the manufacturer's suggested retail prices. Actual retail prices may vary.

Notice: The prices appearing in this catalog are the manufacturer's suggested retail prices. Actual retail prices may vary.

SOFTAIL

166 CRUISER

Saddlebags & Luggage

A. LOCKING LEATHER COVERED RIGID SADDLEBAGS

These saddlebags offer a premium leather look with an extra-durable construction. The blow-molded core keeps the bag rigid and prevents sagging, while the unique lids open outward for added flair. Bags feature locks for additional security. Luggage capacity: 1800 cubic inches total.

53061-00B \$897.95

Fits '00-'17 Softail® models (except FLS, FLSS, FLSTNSE, FXCW, FXCWC, FXS, FXSB, FXSBSE, FXSE and FXSTD). Also fits '09 FXSTSSE models. FXSTC models require separate purchase of Hardware Kit P/N 90573-07. Fits '84-'99 Softail models with separate purchase of Directional Relocation Kit P/N 53692-96. (FLST, FLSTC and FLSTS models do not require this Directional Relocation Kit). (Does not fit '84-'99 models equipped with H-D® Detachables™ accessories). Does not fit with Rear Axle Covers, Wide Tire Kit P/N 43684-99 or Flat Lens Turn Signal Kit P/N 68431-95. FLSTFBS models require the removal of Original Equipment Rear Axle Covers.

Note: Installation of these saddlebags with the following seats requires the use of Spacer Kit P/N 90976-01A: seats with rider backrests, Sundowner™ seats, stock FLSTF seat, stock FLSTC, FXSTC seat and any other seats that contact the lid of the saddlebag. Spacer Kit not required if mounting with Harley-Davidson® Detachables Racks or Sideplates.



A. LOCKING LEATHER COVERED RIGID SADDLEBAGS

B. LOCKING RIGID SADDLEBAGS – SOFTAIL DELUXE STYLING

Styled to complement the nostalgic look of the Softail Deluxe model, these saddlebags with pleated leather panels are anything but traditional. The rigid core allows the bag to retain its shape even after years of use. The hinged locking lid tilts outward for easy access and the embossed weave pattern, braided edging and chrome concho trim echo the Softail Deluxe seat and pillion for a coordinated look. Luggage capacity: 1900 cubic inches total.

53015-05B \$929.95

Fits '05-'17 FLSTN models. Does not fit FLSTNSE. Does not fit with Rear Axle Covers.



B. LOCKING RIGID SADDLEBAGS – SOFTAIL DELUXE STYLING

C. HERITAGE SOFTAIL® MODEL SADDLEBAGS

Original Equipment on the '06-'08 Heritage Softail® Classic model, these top grade cowhide saddlebags feature reinforced rim and sides to help maintain their shape. The bags are decorated with chrome studs and a chrome-plated brass medallion coined with the Harley-Davidson logo. Saddlebag tops have rivet-reinforced corners and are secured with heavy leather straps that conceal quick-release hardware. Luggage capacity: 2200 cubic inches total.

90876-05 \$798.95

Fits '00-'17 FLSTC models. Also fits '00-'17 FLST models (except FLSTN, FLSTNSE, and '10-'12 FLSTSE) with the separate purchase of Saddlebag Hardware Kit P/N 79304-06.



C. HERITAGE SOFTAIL STYLE SADDLEBAGS

NOTE: Some Harley-Davidson® saddlebags are made of leather. Fine leathers or other natural materials WILL gain "character," such as wrinkles or wear, with age. This is normal. A fine, aged patina and character wrinkles are a sign of the extremely high-quality materials used to construct your saddlebags. The appearance of scars or marks on the leather are a result of using natural leather panels and should not be thought of as an imperfection. Please use Harley-Davidson® Leather Protectant P/N 93600034 to protect your investment.

Notice: The prices appearing in this catalog are the manufacturer's suggested retail prices. Actual retail prices may vary.



D. UNIVERSAL SADDLEBAG LOCK KIT

CRUISER 167

Saddlebags & Luggage

D. UNIVERSAL SADDLEBAG LOCK KIT

Keep the contents of your existing soft-sided saddlebags safe from the grab-and-go thief. This unique kit features two extra-small barrel locks that can replace existing saddlebag snaps to perform double duty as locks or as snaps when you don't need to lock your bags. Can be keyed to match your barrel-style ignition key. Sold in pairs.

Fits most soft-sided leather and vinyl saddlebags. Does not fit FLHRC and FLHRS.

90300003 Keyed To Match. \$64.95

90300017 Random Key Code. \$59.95



SINGLE-SIDED SWINGARM BAG

Less is more. With enough room for the essentials, these stylish Swingarm Bags eliminate the need to stuff your pockets or bungee a bag across the passenger pillion. Shaped to hug the contour of your bike's frame, these compact bags add an old-school look. Bags are constructed of heavyweight leather and feature a pouch-style flap lid that is secured with two traditional straps and buckles. The semi rigid-backed bag is secured to the left side of the bike with easy-to-install adjustable straps. Luggage capacity: 450 cubic inches total.

E. SINGLE-SIDED SWINGARM BAG – ANTIQUE BROWN LEATHER

Crafted from supple brown pull-up leather, this classic Swingarm Bag will gain character and a well-worn authentic look with use. The flip-open lid is secured with traditional straps and buckles, and the bag features antique hardware that complements the old-school look.

90201568 \$242.95

Fits '00-later Softail® models (except FLSTC, FLSTNSE, FLSTSE, FXDRS, FXCW, and FXCWC). Does not fit models equipped with left-hand tool box, passenger footboards, chrome swingarm covers, saddlebags, or saddlebag guards.

F. SINGLE-SIDED SWINGARM BAG – BLACK LEATHER

Constructed with heavy boot-grade leather, this rich black Swingarm Bag is the perfect complement to any paint color or customizing style. The flip-open lid is secured with quick-disconnect clips hidden behind the traditional leather straps and brushed nickel-finished buckles.

90201567 \$242.95

Fits '00-later Softail models (except FLSTC, FLSTNSE, FLSTSE, FXDRS, FXCW, and FXCWC). Does not fit models equipped with left-hand tool box, passenger footboards, chrome swingarm covers, saddlebags, or saddlebag guards.



E. SINGLE-SIDED SWINGARM BAG – ANTIQUE BROWN LEATHER



F. SINGLE-SIDED SWINGARM BAG – BLACK LEATHER

NOTE: Some Harley-Davidson® saddlebags are made of leather. Fine leathers or other natural materials WILL gain "character," such as wrinkles or wear, with age. This is normal. A fine, aged patina and character wrinkles are a sign of the extremely high-quality materials used to construct your saddlebags. The appearance of scars or marks on the leather are a result of using natural leather panels and should not be thought of as an imperfection. Please use Harley-Davidson® Leather Protectant P/N 93600034 to protect your investment.

Notice: The prices appearing in this catalog are the manufacturer's suggested retail prices. Actual retail prices may vary.

SOFTAIL

168 CRUISER

Saddlebags & Luggage

A. BLACK STANDARD LINE SWINGARM BAG

Made of ultra-durable leather-like synthetic featuring a debossed H-D #1 logo, the Black Standard Collection Bags have a simple, black on black style that complements many styling directions and budgets. An internal reinforcement system maintains the bag's shape over time. The "MOLLE-style" system of mounting loops accommodate hook and loop straps and allow for multiple mounting locations and orientations. The bags feature either matte black enamel buckles with hidden quick-detach snaps or a hook and loop flap closure. This Swingarm Bag features matte black buckles with hidden, quick-release buckles underneath. Straight and perpendicular mounting loops provide versatile and easy mounting. This bag is great for storing a small set of tools or additional layers of riding gear. Bag dimensions: 11" W x 11" H x 3.25" D. Internal capacity: 250CI. Weight/Carrying Capacity: 5 lbs.

90201768 **\$143.95**

Fits '00-'17 Softail models (except FLSTC, FLSTNSE, FLSTSE, FXCW, and FXCWC models). Does not fit models equipped with rear axle covers, left-hand tool box, passenger footboards, chrome swingarm covers or saddlebag guards. FLSS and FLSTFBS models require removal of Original Equipment Rear Axle Covers.

B. BLACK STANDARD LINE THROW-OVER SADDLEBAGS

Made of ultra-durable leather-like synthetic featuring a debossed H-D #1 logo, the Black Standard Collection Bags have a simple, black on black style that complements many styling directions and budgets. An internal reinforcement system maintains the bag's shape over time. The "MOLLE-style" system of mounting loops accommodate hook and loop straps and allow for multiple mounting locations and orientations. The bags feature matte black enamel buckles with hidden quick-detach buckles underneath. These Throw-Over Bags feature side gussets for increased capacity and straight and perpendicular mounting loops for easy mounting. Quick-release buckles get you in and out of the bag fast. These Throw-Over Bags can be used with or without a passenger pillion. If used with a passenger pillion, the straps should be mounted under the pillion and the crossover straps feature a soft, non-scratch backing. Installation requires purchase of Saddlebag Support rails and may require the purchase of a Turn Signal Relocation Kit. Large bag measures: 16.5" L x 11.5" H x 7" D. Internal capacity: 1,350CI. Weight capacity: 10 lbs/bag. Compact bag measures: 10" L x 11.5" H x 5.25" D. Internal capacity: 600CI. Weight capacity: 6 lbs/bag.

Fits '82-'22 XL (except XL1200T), '08-'17 Dyna® (except FLD), '84-'99 Softail®, and '18-later Softail models equipped with H-D® Saddlebag Supports. '18-later Softail models require purchase of Turn Signal Relocation Kit P/N 67800802 or 68700830.

90201770 Large. **\$295.95**



A. BLACK STANDARD LINE SWINGARM BAG



B. BLACK STANDARD LINE THROW-OVER SADDLEBAGS – LARGE

NOTE: Some Harley-Davidson® saddlebags are made of leather. Fine leathers or other natural materials WILL gain "character," such as wrinkles or wear, with age. This is normal. A fine, aged patina and character wrinkles are a sign of the extremely high-quality materials used to construct your saddlebags. The appearance of scars or marks on the leather are a result of using natural leather panels and should not be thought of as an imperfection. Please use Harley-Davidson® Leather Protectant P/N 93600034 to protect your investment.

Notice: The prices appearing in this catalog are the manufacturer's suggested retail prices. Actual retail prices may vary.

CRUISER 169

Saddlebags & Luggage

C. BLACK STANDARD LINE THROW-OVER SADDLEBAGS

Made of ultra-durable leather-like synthetic featuring a debossed H-D #1 logo, the Black Standard Collection Bags have a simple, black on black style that complements many styling directions and budgets. An internal reinforcement system maintains the bag's shape over time. The "MOLLE-style" system of mounting loops accommodate hook and loop straps and allow for multiple mounting locations and orientations. The bags feature matte black enamel buckles with hidden quick-detach buckles underneath. These Throw-Over Bags feature side gussets for increased capacity and straight and perpendicular mounting loops for easy mounting. Quick-release buckles get you in and out of the bag fast. These Throw-Over Bags can be used with or without a passenger pillion. If used with a passenger pillion, the straps should be mounted under the pillion and the crossover straps feature a soft, non-scratch backing. Installation requires purchase of Saddlebag Support rails and may require the purchase of a Turn Signal Relocation Kit. Large bag measures: 16.5" L x 11.5" H x 7" D. Internal capacity: 1,350CI. Weight capacity: 10 lbs/bag. Compact bag measures: 10" L x 11.5" H x 5.25" D. Internal capacity: 600CI. Weight capacity: 6 lbs/bag.

Fits '82-'22 XL (except XL1200T), '08-'17 Dyna® (except FLD), '84-'99 Softail®, and '18-later Softail models equipped with H-D® Saddlebag Supports. '18-later Softail models require purchase of Turn Signal Relocation Kit P/N 67800802 or 68700830.

90201769 Compact. **\$242.95**

D. TOUR-PAK® LUGGAGE

Add cross-country luggage capacity to your ride with accessory Tour-Pak® Luggage. A cavernous interior will hold one full-face helmet or two half helmets. Kit includes backrest pad, interior rubber mat, hardware and instructions. Luggage Capacity: 2500 cubic inches. Dimensions: 18.5" W x 17.0" D x 13.0" H. Racks and docking kits sold separately. International models may require separate purchase of License Plate Relocation Kit P/N 60095-00A.

Fits '04-'22 XL (except XL883N, XL1200C, XL1200N and XL1200T) equipped with Solo Tour-Pak Rack, '00-'17 Softail® (except FLS, FLSS, FLSTNSE, FLSTSE, FXCW, FXCWC, FXS, FXSB, FXSBSE, FXSE, FXSTD and '09 FXSTSSE) equipped with H-D® Detachables™ Solo or Two-Up Tour-Pak Rack and '97-'13 Touring models equipped with H-D Detachables Two-Up or Solo Tour-Pak Racks.

53690-06A **\$575.95**
Smooth Vinyl.



C. BLACK STANDARD LINE THROW-OVER SADDLEBAGS – COMPACT



D. TOUR-PAK LUGGAGE – SMOOTH VINYL

Notice: The prices appearing in this catalog are the manufacturer's suggested retail prices. Actual retail prices may vary.

170 CRUISER

Foot Controls

A. BILLET STYLE HEEL/TOE SHIFT LEVER – EXTENDED REACH

Stretch out in style. Both the heel and toe sections of this Shift Lever are 1.0" longer than traditional levers, separating the distance between the heel/toe shift by 2.0" total. This added space provides a comfortable riding position for a tall rider and allows a rider with a large boot extra room to move. Styled to complement our billet style mirror stems, these Billet Style Shift Levers are forged, machined and polished for a beautiful, custom look. When combined with the available Extended Reach Brake Lever, long-limbed riders can straighten their legs and ride in comfort. Kit includes a front and rear lever and mounting hardware.

33600001 Chrome. **\$178.95**
Fits '86-'17 FL Softail®, '88-later Touring and '08-later Trike models.

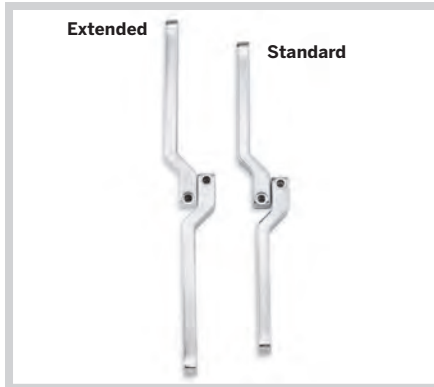

SHIFT LEVER COMPARE

B. BILLET STYLE HEEL/TOE SHIFT LEVER – STANDARD LENGTH

Styled to complement our billet style mirror stems, these Billet Style Shift Levers are forged from 7075-T6 aluminum, then machined and polished for a beautiful, custom look. Available in your choice of mirror chrome, satin black powder coat or edge cut black anodized and machined aluminum finishes. Kit includes a front and rear lever and chrome hardware.

Fits '86-'17 FL Softail, '88-later Touring and '08-later Trike models.

34535-00B Chrome. **\$178.95**
34045-10 Edge Cut. **\$178.95**
34023-08 Satin Black. **\$178.95**



B. BILLET STYLE HEEL/TOE SHIFT LEVER – STANDARD LENGTH, CHROME

C. FOLDING HEEL SHIFTER

Give your left foot a little extra room. Folding Heel Shifter permits the rider to move the rear shift peg out of the way when on the open road, while retaining heel/toe shift functionality around town. Positive detent holds the peg in the selected position and can be adjusted while riding. Easy to install, the replacement rear lever is chrome-plated and shaped to match the Original Equipment toe shift lever. Lever accepts stock or accessory shifter peg.

33876-07 **\$89.95**
Fits '86-'17 FL Softail, '88-'16 Touring and '08-'16 Trike models.



B. BILLET STYLE HEEL/TOE SHIFT LEVER – STANDARD LENGTH, SATIN BLACK

D. HEEL/TOE SHIFTER SHAFT COVER

Conceal the splined end of the shifter shaft when you remove the heel shift lever. The easy-to-install chrome-plated aluminum billet cap is held in place with a flush Allen® screw for a clean look.

35471-05 **\$22.95**
Fits '82-'17 FL Softail®, and '82-later Touring and Trike models equipped with heel/toe shift levers. Installation requires removal of heel shift lever.



D. HEEL/TOE SHIFTER SHAFT COVER



A. BILLET STYLE HEEL/TOE SHIFT LEVER – EXTENDED REACH



B. BILLET STYLE HEEL/TOE SHIFT LEVER – STANDARD LENGTH, EDGE CUT



C. FOLDING HEEL SHIFTER



E. FORWARD CONTROL KIT FOR FL SOFTAIL MODELS



F. BILLET STYLE SHIFT LEVER – CHROME



F. BILLET STYLE SHIFT LEVER – EDGE CUT



F. BILLET STYLE SHIFT LEVER – SATIN BLACK



G. RIDER FOOTBOARD HEEL GUARD

CRUISER 171

Foot Controls

E. FORWARD CONTROL KIT FOR FL SOFTAIL® MODELS*

This kit converts the standard FL Softail® footboard controls to Original Equipment FX Softail forward controls. The resulting foot-forward riding position takes the long-limbed rider out of the upright flat-foot, knees-up stance and puts him or her in a relaxed laid-back posture. Kit includes left and right brackets, shift lever, brake lever and all necessary mounting hardware. Footpegs and brake pedal pad sold separately.

33909-08A **\$393.95**

Fits '07-'17 FLSTC, FLSTF (except FLS, FLSS, FLSTFB and FLSTFBS), FLSTN, FLSTSB and FLSTSC models. Requires separate purchase of appropriate footpeg kit. Compatible footpeg kits for FLSTC and FLSTF are P/N 50305-02, 50359-04, 50370-04, 50474-03, 50500-03, 50506-03, 50576-05, 50695-08 or 50935-07. FLSTN, FLSTSB and FLSTSC require separate purchase of stock FXCW footpegs with wear pegs (P/N 51327-08 Left Peg, 51323-08 Right Peg and 33130-07A Wear Peg (Qty 2)). Does not fit with Profile® Low Suspension.

F. BILLET STYLE SHIFT LEVERS

Styled to complement our billet style mirror stems, these Billet Style Shift Levers are forged from 6061-T6 aluminum, then machined and polished for a beautiful, custom look. Includes chrome hardware. Shift pegs sold separately.

Fits '91-'17 Dyna® (except '14-'17 FXDL, FXDLS or models equipped with Further Forward Mid-Control Kit P/N 50500386) and '90-'17 FX Softail models.

34539-00 Chrome. **\$99.95**
34043-10 Edge Cut. **\$104.95**
34016-08 Satin Black. **\$99.95**

G. RIDER FOOTBOARD HEEL GUARD

This Heel Guard mounts to the right-side rider footboard and protects your boot from contact with the hot exhaust shield. Kit includes chrome guard with cutaway Bar & Shield logo and all mounting hardware.

50500225 **\$74.95**

Fits '12-'16 FLD, '86-'17 FL Softail, '86-later Touring and '09-later Trike models equipped with Traditional and Swept Wing footboards. Does not fit models equipped with Half-Moon, Tapered, Airflow, Defiance, Dominion™ or Burst Wing footboards, Extended Reach Rider Footboards P/N 50409-04 or 54145-10, Rider Running Boards P/N 50500158 or Screamin' Eagle® Fat Exhaust Shield.



***WARNING:** Installation of this kit may affect cornering clearance. This could distract the rider, causing loss of control, resulting in death or serious injury.

172 CRUISER

Foot Controls

A. GEAR SHIFTER LINKAGE COVER

A simple and inexpensive way to detail your Softail® model. This easy-to-install chrome-plated cover conceal the stock shifter linkage for a brilliant finish. Kit includes all necessary mounting hardware.

46302-01 Harley-Davidson Script. **\$50.95**
Fits '99-'17 Softail® models (except FLSTSE) with stock shifter linkage.



A. GEAR SHIFTER LINKAGE COVER – HARLEY-DAVIDSON SCRIPT

B. CUSTOM GEAR SHIFT LINKAGE – ROUND GLOSS BLACK

Add the finishing touch to your blacked-out ride. This Gloss Black Shift Linkage is easy to install and includes a transmission lever cover and decorative acorn nuts and bolts for a complete custom look.

33600259 **\$111.95**
Fits '86-later Softail (except '18-later FXBB, FXLR, FXLRS and '20-later FXST), Touring and Trike models. (Does not fit '97-'99 FLSTS or models equipped with Softail Extended Reach Forward Controls.)



B. CUSTOM GEAR SHIFT LINKAGE – ROUND GLOSS BLACK

C. CUSTOM GEAR SHIFT LINKAGES

Kick your custom into gear with this collection of high-quality custom shift linkages. Available in a variety of designs to match your bike's style, these linkages feature aircraft-quality rod ends for easy adjustment and smooth operation. The easy-to-install linkage kit also includes a transmission lever cover for '86-'17 Softail and '86-'16 Touring and Trike models, and decorative acorn nuts and bolts for a complete custom look.

Fits '86-later Softail (except '18-later FXBB, FXLR, FXLRS and '20-later FXST), Touring and Trike models. (Does not fit '97-'99 FLSTS or models equipped with Softail Extended Reach Forward Controls.)

1. 34018-08	Slotted Black Anodized.	\$142.95
2. 34850-09	Skull.	\$139.95
3. 33801-09	Harley-Davidson Script.	\$139.95
4. 33760-09	Slotted with Bar & Shield Logo.	\$142.95
5. 33814-98A	Round.	\$99.95



C. CUSTOM GEAR SHIFT LINKAGES

Notice: The prices appearing in this catalog are the manufacturer's suggested retail prices. Actual retail prices may vary.

CRUISER 173

Foot Controls

D. PASSENGER FOOTPEG MOUNT KIT

A necessary addition when converting your solo seat model to a two-up passenger-carrying ride. Kit includes black mounting brackets and all necessary mounting hardware. Footpegs sold separately.

50932-08 **\$59.95**
Fits '12-'17 FLS, FLSS and '08-'11 FLSTSB models.



D. PASSENGER FOOTPEG MOUNT KIT

E. PASSENGER FOOTBOARD AND MOUNT KITS

Add passenger comfort and support. These complete kits include specially designed mounting stud/brackets for convenient bolt-on installation. Footboards fold up when not in use. Available in your choice of Original Equipment or mirror-chrome finish, these kits include footboard pans, rubber pads, mounting hardware and matching chrome or black footboard supports. NOTE: Passenger Footboard Kits cannot be used with Pivot Bolt Covers.

Fits '00-'17 Softail® models (except FLS, FLSS, FLSTF, FLSTFB, FLSTFBS, FLSTN, FLSTNSE, FLSTS, FLSTSB, FLSTSC, FLSTSE, FXS, FXSBSE, FXCW, FXCWC and FXSTD). '00-'15 FLSTC models require Saddlebag Bracket Relocation Kit P/N 90238-00.

50602-00A	Black.	\$292.95
52715-04A	Chrome.	\$432.95

F. PASSENGER FOOTBOARD SUPPORT KITS

Add the comfort and convenience of passenger footboards to your Softail motorcycle. These support kits are designed to allow installation of traditional D-shaped, Swept Wing, Tapered or Old-Style Passenger Footboards (sold separately) on Softail models. Kit includes left and right supports, footboard mount hinge pins and installation hardware.

Fits '00-'17 Softail models (except FLS, FLSS, FLSTF, FLSTFB, FLSTFBS, FLSTN, FLSTNSE, FLSTS, FLSTSB, FLSTSC, FLSTSE, FXS, FXSBSE, FXCW, FXCWC and FXSTD). '00-'15 FLSTC models require Saddlebag Bracket Relocation Kit P/N 90238-00.

50459-06	Black.	\$165.95
-----------------	--------	-----------------

Fits '07-'17 FLSTF, FLSTFB, FLSTFBS, FXS and FXSTD models.

50399-07A	Black.	\$160.95
------------------	--------	-----------------



E. PASSENGER FOOTBOARD AND MOUNT KIT – BLACK



E. PASSENGER FOOTBOARD AND MOUNT KIT – CHROME



F. PASSENGER FOOTBOARD SUPPORT KIT – BLACK (50459-06 SHOWN)

Notice: The prices appearing in this catalog are the manufacturer's suggested retail prices. Actual retail prices may vary.

SOFTAIL

174 CRUISER

Foot Controls

A. MINI FOOTBOARD KITS

Fits rider position:

'02-'17 VRSC™ models with forward controls (except VRSCDX and VRSCF), '06-earlier XL, '07-'10 XL883, XL883C, XL883R, XL1200C and XL1200R, '07-'11 XL1200L, '91-'17 Dyna® (except FLD), and '84-'17 Softail® models with forward controls (except FXCW, FXCWC, FXS, FXSB, FXSBSE and FXSE).

Fits passenger position:

All models with H-D® male-mount passenger peg mounts (except '06-earlier VRSC, '03-earlier XL, '05-earlier Dyna and Softail models equipped with Shotgun exhaust). '84-'17 Softail models require separate purchase of Support Kit PN 50454-09. Does not fit passenger position on '18-later Softail models.

Fits highway peg position:

All models with frame-mount or engine guard-mount highway pegs (except Whiskers Adjustable Highway Bar P/N 50855-09 and 50865-09).

50500139	Small 3" – Chrome.	\$139.95
50500144	Small 3" – Gloss Black.	\$139.95
50500109	Large 4" – Chrome.	\$139.95
50500124	Large 4" – Gloss Black.	\$139.95

Also available:

PASSENGER FOOTBOARD SUPPORT KIT

Required for installation of Mini Footboards in the passenger position on many Softail motorcycles.

50454-09	\$64.95
-----------------	----------------

Required for installation of Mini Footboards P/N 50451-09, 50500109, 50500124, 50500139, 50500144 on '08-'17 Softail models. Does not fit FLS, FLSS, FLSTF, FLSTFB, FLSTFBS, FLSTN, FLSTSB, FXS, FXSBSE, FXSTD and Softail models with shotgun exhaust. FLSTC and FLSTS models require the separate purchase of Saddlebag Bracket Relocation Kit P/N 90238-00.

B. REAR SADDLEBAG GUARDS – CHROME*

Saddlebag guards provide a style borrowed from the past that makes a unique statement here and now. Includes mounting hardware and instructions.

49261-00A	\$258.95
------------------	-----------------

Fits '00-'17 FLST and FLSTC and '00-'05 FXST, FXSTB and FXSTS models. FLSTC models require Saddlebag Relocation Kit P/N 90238-00.

Also available:

SADDLEBAG BRACKET RELOCATION KIT (not shown)

Required for installation of FLSTS Rear Saddlebag Guards P/N 49258-00A and FLSTC Rear Saddlebag Guard P/N 49261-00.

90238-00	\$18.95
-----------------	----------------

Fits '00-'17 FLSTC, FLSTS and FLSTSB models.

C. ERGO JIFFY STAND

Kit replaces Original Equipment jiffy stand and includes stand bumper, bushing and all required mounting hardware.

50000091	\$127.95
-----------------	-----------------

Fits '07-'17 Softail models (except FXSB, FXSBSE and FXSE). Stock on '15-'17 FLS, FLSS, FLSTFB, FLSTFBS, FLSTN and FLSTNSE models. Does not fit models equipped with Defiance footboards, Burst footboards or Rider Running Boards P/N 50500158.



A. MINI FOOTBOARD KIT



B. REAR SADDLEBAG GUARDS – CHROME (49261-00A SHOWN)



C. ERGO JIFFY STAND



D. MUSTACHE ENGINE GUARD – CHROME



D. MUSTACHE ENGINE GUARD – GLOSS BLACK



E. ENGINE GUARD – CHROME



F. ENGINE GUARD – GLOSS BLACK



G. NOSTALGIC CURVED ENGINE GUARD – CHROME



H. SOFT LOWERS

CRUISER 175

Engine Guards

D. MUSTACHE ENGINE GUARD*

Combine classic shape and modern function for a unique twist on engine protection. The flow of this engine guard complements the bike's traditional style while the gracefully curved upper section incorporates highway pegs into the shape. The integrated rubber pads offer a comfortable and slip-resistant cushion for your feet while traveling the open road. One-piece engine guard kit includes all required mounting hardware.

Fits '00-'17 FL Softail® models.

49140-05B	Chrome.	\$307.95
49440-10	Gloss Black.	\$307.95

E. ENGINE GUARD – CHROME*

Protect your bike without sacrificing ground clearance or style. The one-piece engine guard is designed to complement the lines of the motorcycle and the bright chrome finish adds the perfect finishing touch.

49004-00A	\$235.95
------------------	-----------------

Fits '00-'17 FL Softail models.

49200-07A	\$235.95
------------------	-----------------

Fits '00-'17 FX Softail models (except models equipped with Extended Reach Forward Control Kit P/N 49171-04 or 49223-04). FXSE models require the removal of the stock Original Equipment Chin Spoiler.

49004-90	\$250.95
-----------------	-----------------

Fits '86-'99 FL Softail models.

F. ENGINE GUARD – GLOSS BLACK*

A serious finish for serious riders. Before a black powder coat, these engine guards get an extra layer of protection from an E-Coat dip. So go on and install Engine Guard Mount Footpegs because this finish will go the distance.

49023-02A	\$235.95
------------------	-----------------

Fits '00-'17 FL Softail models.

G. NOSTALGIC CURVED ENGINE GUARD – CHROME*

The nostalgic curved shape adds classic style to functionality. Reminiscent of the vintage 1940s style, the one-piece chrome Engine Guard complements the lines of the classic style Softail Deluxe, Heritage Softail® Classic and FL Springer™ models.

49037-05A	\$235.95
------------------	-----------------

Fits '00-'17 FL Softail models. Compatible with Engine Footpeg Mount Kit P/N 49102-86T or 49144-86.

H. SOFT LOWERS

Extend your riding season. Full-coverage Soft Lower provide wind and mud protection for the rider's legs and boots and minimize cold updrafts as the weather changes. Covers are custom shaped to hug the engine guard to minimize flapping and they simply clip in place for speedy installation as the weather changes. Two-way zippered outer edge accommodates guard-mounted highway pegs in almost any position. Reflective piping provides added visibility and the rigid inner panel provides ample clearance around the foot controls.

57100213	\$126.95
-----------------	-----------------

Fits '86-'17 FL Softail models equipped with Engine Guard P/N 49004-90 or 49004-00A. Does not fit Mustache or Nostalgic Engine Guards. Does not fit models with forward controls, Extended Reach Brake Lever or Extended Reach Shift Lever.



***WARNING:** Do not use highway pegs under normal stop and go operating conditions. Doing so could result in death or serious injury.



***WARNING:** Do not use highway pegs under normal stop and go operating conditions. Doing so could result in death or serious injury.



***WARNING:** Engine guards may provide limited leg and cosmetic vehicle protection under unique circumstances (fall over while stopped, very low speed slide). They are not made nor intended to provide protection from bodily injury in a collision with another vehicle or any other object.

Notice: The prices appearing in this catalog are the manufacturer's suggested retail prices. Actual retail prices may vary.

Notice: The prices appearing in this catalog are the manufacturer's suggested retail prices. Actual retail prices may vary.

SOFTAIL

176 CRUISER

Chassis Trim – Front End

A. FRONT END KIT – CHROME

The front forks on a Harley-Davidson® motorcycle set the tone for the bike and can lead the way to a full-bore custom statement. So start customizing by adding chrome where it will have the most noticeable impact on the overall look of the bike, the front end. A perfect addition during the installation of Premium Ride or Profile® Low Front suspension components, this kit includes components necessary to completely chrome the front forks. Kit includes some or all of the following (Kit components vary depending on your model): Chrome Fork Sliders, Oil Seals, Chrome Fork Axle Retainer Nut Kit, Chrome Fork Slider Drain Screw Kit, Classic Chrome Front Axle Nut Cover Kit and Chrome Upper Fork Nut Covers. Chrome Front End Package price does not include labor or supplies.

45400006 \$690.95
Fits '12-'17 FLS, FLSS, FLSTF, FLSTFB and FLSTFBS, '09-'17 FLSTC and '07-'17 FLSTN models. Also fits '07-'08 FLSTC with separate purchase of front fork cover P/N 67830-09.

B. LOWER FORK SLIDERS – CHROME

Competitively priced, these chrome-plated Lower Fork Sliders give your bike upfront style. To ensure proper fitment and function, these sliders are manufactured from Original Equipment components. Form followed function, with polished, chrome plating and a stamped Harley-Davidson logo for product identification. A perfect addition during the installation of Premium Ride or Profile Low Front suspension components, this kit includes right and left sliders and the bottom axle retainer. '07-later model kits also include chrome drain screws, axle retainer bolts and oil seals.

45500014 \$478.95
Fits '07-'17 FLS, FLSS, FLSTC and FLSTN and '08-'17 FLSTF, FLSTFB and FLSTFBS models.

46482-00 \$478.95
Fits '00-'06 FLST, FLSTC, FLSTF and FLSTN models.

45310-98 \$478.95
Fits '86-'99 FLSTC, FLSTF and FLSTN models.

46477-00 \$478.95
Fits '00-'05 FXDWG and '00-'06 FXST and FXSTB models.

Also available:

FRONT FENDER HARDWARE KIT – CHROME

Finish the show-winning look with brilliant chrome hardware. Manufactured to Original Equipment specifications, this kit replaces the zinc-plated exposed front fender mounting bolts with chrome-plated socket head cap screws.

94415-05 \$11.95
Fits '93-'05 FXDWG and '91-'17 Softail® models (except Springer™, FXCW, FXCWC, FXSB, FXSBSE, FXSE and FXSTD). Does not fit with Billet Fork Slider Kit or Inverted Front End Kit.

C. LOWER FORK SLIDERS – GLOSS BLACK

These gloss black coated sliders are the ultimate extension of your bike's "dark side" and make a perfect custom addition to your blacked-out FL Softail® model. Manufactured to Original Equipment specifications, the durable black coating is a great match to other H-D® black components. Add matching Gloss Black Upper Fork Slider Covers P/N 45591-02 for a complete look. A perfect addition during the installation of Premium Ride or Profile Low Front suspension components, this includes right and left sliders, bottom axle retainers, drain screws, axle retainer bolts and oil seals.

45500015 \$478.95
Fits '07-'17 FLS, FLSS, FLSTC, FLSTN and FLSTNSE, '08-'17 FLSTF, FLSTFB, FLSTFBS and '10-'12 FLSTSE models.



A. FRONT END KIT – CHROME (FAT BOY SHOWN)



B. LOWER FORK SLIDERS – CHROME



C. LOWER FORK SLIDERS – GLOSS BLACK



CRUISER 177

Suspension

D. PROFILE® LOW FRONT SUSPENSION*

Designed by Harley-Davidson to lower the front fork approximately 1.0" while preserving ride quality. The kit includes springs that are progressively wound for a compliant, yet controlled ride. Must only be installed on vehicles equipped with low-profile rear suspension.

54758-07 \$118.95
Fits '07-'17 FLS, FLSS, FLSTC and FLSTN, '08-'17 FLSTF, FLSTFB, FLSTFBS and '14-'17 FLSTNSE models. FLSTC, FLS (AUS/BRZ/APC), FLSTF and FLSTF Special (Europe/UK) models must also be equipped with Profile® Low Rear Suspension Kit P/N 54651-05, 54652-05 or 54001-04A.

E. PROFILE LOW REAR SUSPENSION*

This suspension lowers the seat height approximately .75" while preserving ride quality. Spring and damping rates are tailored for Softail models to ensure a controlled ride. Shocks feature multi-staged damping to ensure optimal performance under varying conditions. Compatible with Profile Low Front Suspension.

54651-05 Chrome \$452.95
Fits '00-'17 FLSTC, FLSTB, FLSTF, FLSTS, FXST, FXSTB, FXSTC and FXSTS models. Also fits '10-'17 Fat Boy® Special model in UK, Europe, Brazil and select international markets that are factory-equipped with standard-height rear suspension.

F. COMFORT FLEX REAR SHOCKS*

For the rider willing to exchange the low-profile, slammed look for improved ride comfort. Standard-length shocks raise the seat height of a factory-lowered bike approximately 1.0" and deliver an improved ride through a longer stroke. Spring rates and damping are tailored to ensure a controlled ride and optimal performance under varying conditions.

54000041 \$326.95
Fits '05-'17 FLS, FLSS, FLSTFB, FLSTFBS, FLSTN, FLSTNSE, '05-'06 FLSTFSE, '08-'11 FLSTSB, '10-'12 FLSTSE, '07-'09 FXSTSSE, '03 FXSTDSE, '04 FXSTDSE and '07 FXSTD. Stock on '00-'17 FL and FX models equipped with standard height rear shocks. Cannot be used on models equipped with Profile Low Front Suspension Kits.



D. PROFILE LOW FRONT SUSPENSION – FL SOFTAIL



E. PROFILE LOW REAR SUSPENSION – CHROME



F. COMFORT FLEX REAR SHOCKS



***WARNING:** The Profile Low Front Spring Kit cannot be used independently and must be used with the appropriate Profile Rear Shock Lowering Kit. Installation of any accessory suspension components may affect cornering clearance and jiffy stand operation. This could distract the rider, causing loss of control and death or serious injury.



***WARNING:** Installation of any accessory suspension components may affect cornering clearance and jiffy stand operation. This could distract the rider, causing loss of control and death or serious injury.

Notice: The prices appearing in this catalog are the manufacturer's suggested retail prices. Actual retail prices may vary.

Notice: The prices appearing in this catalog are the manufacturer's suggested retail prices. Actual retail prices may vary.

178 CRUISER

Chassis Trim

A. PREMIUM TANK PANEL WITH POUCH

This leather tank panel features an over-sized pouch for convenient, at your fingertips storage. The heavy duty leather pouch will maintain its shape for miles to come while the bold chrome Bar & Shield medallion sits proudly on the flap for all to admire.

91135-09 \$127.95
Fits '93-'08 FXDWG, '06 FXD35, '07-'17 FXDC and FXDF and '00-'17 Softail® models (except FLS, FLSS, FLSTNSE, FLSTSB, FLSTSE, FXCW, FXCWC, FXS, FXSB, FXSBSE, FXSE, FXSTD, FXSTSSE, '09-'17 FLSTC and '06 FLSTFSE). '93-'03 FXDWG models require the separate purchase of Clip P/N 10102 and O-Ring P/N 11174.



A. PREMIUM TANK PANEL WITH POUCH

B. DASH PANEL EXTENSION – CHROME

Stretch the lines of your chrome dash panel the full length of the fuel tank. This chrome-plated trim kit continues the lines and finishes of your standard tank panel to the front of the seat, adding a custom touch without the expense of a custom tank.

71283-01 \$47.95
Fits '00-'17 Softail models (except FLS, FLSS, FLSTNSE, FLSTSB, FLSTSE, FXCW, FXCWC, FXS, FXSB, FXSBSE, FXSE, FXSTD, FXSTSSE, '06 FLSTFSE and '09-'17 FLSTC models).



B. DASH PANEL EXTENSION – CHROME

C. UPPER FORK SLIDER COVERS – CHROME

Brilliant chrome accents for the upper fork legs. Perfect for finishing off that chromed front end look. When used with H-D® Genuine Motor Accessory Chrome Lower Fork Sliders, you've got a front end that's completely chromed and an appearance that's utterly impressive.

45963-97 \$84.95
Fits '49-'84 FL, '86-'17 FLS, FLSS, FLST, FLSTC, FLSTF (except '07), FLSTFB, FLSTFBS and FLSTN and '80-'13 Touring and Trike models. Stock on FLSTNSE and FLSTSE models.



C. UPPER FORK SLIDER COVERS – CHROME

D. UPPER FORK SLIDER COVERS – GLOSS BLACK

The classic Harley-Davidson® motorcycle color is black. It shows your attitude, your feelings and your desire to be different from the rest. These gloss black accessories are the ultimate extension of the Harley-Davidson philosophy. Manufactured from Original Equipment components, these parts provide superior fit and finish.

45591-02 \$84.95
Fits '49-'84 FL, '86-'17 FLS, FLSS, FLST, FLSTC, FLSTF (except '07), FLSTFB, FLSTFBS, FLSTNSE and FLSTN, '10-'12 FLSTSE and '80-'13 Touring and Trike models.



D. UPPER FORK SLIDER COVERS – GLOSS BLACK

E. ABS FRONT WHEEL SPACERS

It is all in the details. Complete your total front end with these wheel spacers in mirror chrome finish. Manufactured to the Original Equipment tolerances, they deliver the exact fitment and custom shine. Chrome is Original Equipment on FLSTNSE

43300010 Chrome \$54.95
Fits '11-'17 FLS, FLSS, FLSTF, FLSTC and FLSTN models with ABS brakes. FLSTC and FLSTN models require removal of Original Equipment hub cap.



E. ABS FRONT WHEEL SPACERS – CHROME

F. ABS HARNESS COVER – CHROME

Dress your ABS-equipped Softail model in style. Shaped to conceal the ABS wheel speed sensor harness, this bracket mounts to the brake caliper tabs on the lower fork sliders. The mirror chrome finish complements the Original Equipment satin polished sliders or serves as the final finishing touch to a complete chrome front end.

32700002 \$44.95
Fits '11-'17 Softail® models (except FXCWC, FXSB and FXSBSE) equipped with ABS.



F. ABS HARNESS COVER – CHROME



G. FORK COVER KIT – CHROME



G. FORK COVER KIT – CHROME



H. FORK COVER SIDE PANELS – CHROME



I. FORK COVER ACCENT STRIP KIT – CHROME



J. TIE-DOWN BRACKETS – CHROME



K. FORK COVER ACCENT STRIPS – GLOSS BLACK

CRUISER 179

Chassis Trim – Front End

G. FORK COVER KIT – CHROME

Replace your factory-original satin fork covers with these brilliant, triple chrome-plated versions for a custom mirror-like shine.

67890-91C \$149.95
Fits '86-'08 FLST, FLSTF and FLSTFB and '93-'17 FLSTN models. Does not fit FLSTC with Original Equipment light bar or models with Auxiliary Lighting Kit P/N 69287-07 or 68000026.

H. FORK COVER SIDE PANELS – CHROME

Complete the chrome finish of the Softail® Deluxe model Fork Cover. These side panels replace the polished panels that wrap around the rear of the triple tree. Easy to install, this kit includes left and right side panels.

66441-05 \$83.95
Fits '09-'17 FLS, FLSS and FLSTC, '07-'17 FLSTF, FLSTFB, FLSTFBS and '05-'17 FLSTN models. Stock on FLSTNSE.

I. FORK COVER ACCENT STRIP KIT – CHROME

Sometimes the best ideas come from you, our fellow riders, like this chrome accent strip. This kit is designed to add the ultimate complement to the already popular Chrome Fork Cover Kit by accenting the sides with beautiful chrome-plated aluminum strips. Kit includes chrome hardware.

67891-99 \$33.95
Fits '86-'11 FLSTF and FLSTFB and '93-'96 FLSTN models with Chrome Fork Cover Kit P/N 67890-91C or 66440-05. Stock on '12-'17 FLS, FLSTF and FLSTFB. Does not fit with passing lamps and windshields.

J. TIE-DOWN BRACKETS – CHROME

Simplify the process of securing your bike to a trailer or bike lift. These stylish chrome Tie-Down Brackets mount cleanly to the front fork cover and offer a secure method to connect tie-down straps. Moving the tie-down point from the handlebar to the triple tree area reduces wear on the handlebar bushings and ensures a consistent easy-to-access mounting point. Just add Harley-Davidson® Ratchet Straps and Soft Hooks and you're ready to go.

93500006 \$83.95
Fits '02-'17 FLS, FLSS, FLSTC, FLSTF, FLSTFB and FLSTFBS, '95-later FLHR and FLHRC, '95-'13 FLHT, FLHTC and FLHX, '10-'13 FLHTCU and FLHTK, '10-'12 FLHXSE and '10-'12 FLHTCUSE, FLS, FLSS, FLSTF, FLSTFB and FLSTFBS models without a windshield require separate purchase of Hardware Kit P/N 91800030.

Shown with: TIE-DOWN BRACKET HARDWARE KIT

Kit includes 4 button-head bolts required for installation of Chrome Tie-Down Brackets P/N 93500006 on specified models.

91800030 \$11.95
Required for installation of Chrome Tie-Down Bracket Kit P/N 93500006 on '00-'17 FLS, FLSS, FLSTF, FLSTFB and FLSTFBS models without windshields.

K. FORK COVER ACCENT STRIPS – GLOSS BLACK

These strips are designed to add the ultimate complement to the Gloss Black Fork Cover Kit. Finished in matching rich black, these extruded aluminum pieces fill the gap between the front and rear covers that is created when the passing lamps are removed. Strips are sold individually and two are required for a complete installation.

68055-10BHP \$24.95
Fits '86-'17 FLS, FLSS, FLST, FLSTC, FLSTF, FLSTFB and FLSTFBS '93-'96 FLSTN models with Gloss Black Fork Cover Kit P/N 48608-09. (Does not fit with passing lamps or windshields.)

Shown with: HEADLAMP SHELL – GLOSS BLACK

Add to the sinister look of your blacked-out Softail® motorcycle. Manufactured from Original Equipment components, this gloss black headlamp housing replaces the chrome headlamp shell for a custom look. Shell includes wiring harness and connector and accepts the Original Equipment headlamp, trim ring and mounting hardware.

73294-10 \$213.95
Fits '86-'17 FLS, FLSS, FLST, FLSTC, FLSTF, FLSTFB and FLSTFBS and FLSTN models in domestic and right-hand drive markets.

Notice: The prices appearing in this catalog are the manufacturer's suggested retail prices. Actual retail prices may vary.

Notice: The prices appearing in this catalog are the manufacturer's suggested retail prices. Actual retail prices may vary.

SOFTAIL

180 CRUISER

Chassis Trim – Front End

FRONT AXLE NUT COVERS

Cover the front axle in style. Available in your choice of styles, these custom Axle Nut Covers look great with Original Equipment satin-finish fork sliders or add the finishing touch to a complete chrome or blacked-out front end. Easy-to-install kits include all necessary mounting hardware. Sold in pairs.

Fits '02-'11 VRSC™ (except VRSCF and VRSCR), '15-'20 XG, '08-'22 XL, '08-'17 Dyna®, '07-later Softail® (except Springer™, FLSTNSE, FXCW, FXCWC, FXSB, FXSBSE, FXSE, FXST-Aus, and FXSTD) and '08-later Touring and Trike models. '18-later FLDE, FLFB, FLFBS, FLHC, FLHCS, FLSE, FLSE, FLSE, FLSE, FLSE, FXBR, FXBRS and FXLR models require separate purchase of Front Axle Adapter Kit P/N 43000090. '19-'20 FXDRS, '18-later FXFB and FXFBS and '20-later FXRLS, FXLRST and FXRST models. require separate purchase of Front Axle Adapter Kit P/N 43000159.

A. DOMINION™ COLLECTION

Express your bold, renegade attitude. The machined aluminum Dominion™ Collection Front Axle Nut Covers add style to the front of the bike and are the perfect complement to other Dominion Collection accessories.

43000124	Gloss Black.	\$79.95
43000123	Bronze.	\$79.95

B. FRONT AXLE NUT COVERS

1. 44117-07A	Chrome – Die-cast.	\$33.95
44116-07A	Chrome – Billet.	\$53.95
2. 43000026	Gloss Black – Die-cast.	\$33.95
43428-09	Gloss Black – Billet.	\$53.95
3. 43000177	H-D Motor Co. – Black.	\$35.95
4. 44148-07A	H-D Motor Co. – Chrome.	\$35.95
5. 44114-07	Aluminator.	\$53.95

Also available:

Willie G Skull

Fits '02-'11 VRSC (except VRSCF and VRSCR), '15-later XG, '08-'22 XL (except '16-'22 XL1200X and XL1200XS), '08-'17 Dyna, '07-later Softail (except Springer, FLSTNSE, FXCW, FXCWC, FXSB, FXSBSE, FXSE, FXST-Aus, and FXSTD) and '08-later Touring and Trike models. '18-later FLDE, FLFB, FLFBS, FLHC, FLHCS, FLSE, FLSE, FLSE, FLSE, FXBR, FXBRS, FXLR and FXST models require separate purchase of Front Axle Adapter Kit P/N 43000090. '20-later FXRLS, FXLRST and FXRST, '19-later FXDRS and '18-later FXFB and FXFBS models require separate purchase of Front Axle Adapter Kit P/N 43000159.

6. 43000096	Black.	\$38.95
7. 43163-08A	Chrome.	\$38.95

Brass Collection

8. 43000046 **\$64.95**
Fits '02-'11 VRSC (except VRSCF and VRSCR), '15-later XG, '08-'22 XL (except '16-'22 XL1200X and XL1200XS), '08-'17 Dyna, '07-later Softail (except Springer, FLSTNSE, FLSE, FXCW, FXCWC, FXDRS, FXFB, FXFBS, FXLRS, FXSB, FXSBSE, FXSE, FXST-Aus, and FXSTD) and '08-later Touring and Trike models. '18-later FLDE, FLFB, FLFBS, FLHC, FLHCS, FLSE, FXBB, FXBR, FXBRS, FXLR and FXST models require separate purchase of Front Axle Adapter Kit P/N 43000090. '20-later FXRLS, FXLRST and FXRST, '19-later FXDRS and '18-later FLSE, FXFB and FXFBS models require separate purchase of Front Axle Adapter Kit P/N 43000159.

Also available: (not shown)

FRONT AXLE NUT COVERS

Fits '88-'07 XL, '91-'03 FXD, FXDX, FXDXT, FXDL, FXDSCONV, '93-'05 FXDWG, '88-'07 FXR, '87-later FLXR, FXRS-SP and FXWG, '84-'06 Softail (except Springer and FXSTD) and '80-'99 Touring models.

43899-86A	Chrome – Die-cast.	\$33.95
------------------	--------------------	----------------



A. DOMINION FRONT AXLE NUT COVERS – GLOSS BLACK



A. DOMINION FRONT AXLE NUT COVERS – BRONZE



B. FRONT AXLE NUT COVERS



C. DOMINION FORK NUT COVERS – GLOSS BLACK



D. DEFIANCE COLLECTION UPPER FORK STEM COVERS – CHROME



D. DEFIANCE COLLECTION UPPER FORK STEM COVERS – GLOSS BLACK



E. UPPER FORK NUT COVERS – CHROME

CRUISER 181

Chassis Trim – Front End

C. DOMINION™ COLLECTION FORK NUT COVERS

Top it off with style. These easy-to-install Fork Stem Covers top of the triple tree for a cohesive look. A perfect complement to other Dominion™ Collection Accessories, these Fork Nut Covers provide the finishing touch to your bike's front end. Sold in pairs.

Fits '06-'17 Dyna® models (except FXDB and FXDSE) and '18-later Softail® models (except FXDRS, FXFB, FXFBS, FXLRS, FXLRST and FLSE). Also fits '88-'13 XL (except XL1200CX, XL1200X, XL883N) '95-'05 FXD, '93-'05 FXDL, '16-later FXDLS, '94-'05 FXDS-CONV, '90-'17 FLS, FLSS, FLSTF, FLSTFB, FLSTFBS and FLSTN, and '86-'17 FLSTC models.

45800117	Gloss Black.	\$79.95
-----------------	--------------	----------------

D. DEFIANCE COLLECTION UPPER FORK STEM COVERS

Top it off with style. These easy-to-install Fork Stem Covers continue the Defiance Collection to the top of the triple tree for a cohesive look. The deep radial grooves define the style of the Defiance Collection, and the choice of chrome, black or machine cut finishes complement your bike's polished, chrome or blacked-out front end components. Sold in pairs.

Fits '06-'17 Dyna models and '18-later Softail models (except FXDRS, FXFB, FXFBS, FXLRS, FXLRST and FLSE). Also Fits '88-'13 XL (except XL1200CX, XL1200X, XL883N) '95-'05 FXD, '93-'05 FXDL, '16-later FXDLS, '94-'05 FXDS-CONV and '90-'17 FLS, FLSS, FLSTF, FLSTFB, FLSTFBS and FLSTN and '86-'17 FLSTC models.

45500514	Chrome.	\$54.95
45500515	Gloss Black.	\$55.95

E. UPPER FORK NUT COVERS – CHROME

Highlighted with a unique Bar & Shield logo, these polished triple chrome-plated covers add an additional clean looking appearance to your upper fork. Kit comes complete with three covers, mounting hardware and wrench for easy, on-the-spot installation.

46129-98B **\$64.95**

Fits '06-'17 Dyna models (except FLD, FXDB and FXDSE), '88-'13 XL (except XL883C, XL1200C and XL1200S), '95-'05 FXD, '93-'05 FXDL, '16-'17 FXDLS, '94-'05 FXDS-CONV and '90-'17 FLS, FLSS, FLSTF, FLSTFB, FLSTFBS and FLSTN and '86-'17 FLSTC models.

Notice: The prices appearing in this catalog are the manufacturer's suggested retail prices. Actual retail prices may vary.

Notice: The prices appearing in this catalog are the manufacturer's suggested retail prices. Actual retail prices may vary.

182 CRUISER

Chassis Trim – Brakes

A. BRAKE BLEEDER AND BANJO BOLT COVERS

1. Brake Bleeder Screw Cover

This cover adds chrome to the unfinished bleeder valve on all stock H-D® calipers. Package of two.

43834-98 **\$27.95**
Fits '84-later stock calipers (except XG and XR models).

2. Chrome Banjo Bolt Cover

Die-cast chrome cover provides a custom look to your stock banjo bolts. Fits banjo bolts on front and rear brake master cylinders and front and rear calipers. Installs in seconds.

32715-98 **\$26.95**
Fits '84-later models with stock master cylinders and calipers. (Does not fit VRSC™ Rear Master Cylinder, '06-'17 VRSC calipers, '15-later XG, '04-'22 XL, or '08-later Dyna®, Softail®, Touring and Trike models.)



A. BRAKE BLEEDER AND BANJO BOLT COVERS



B. FORK AXLE RETAINER NUT KIT – CHROME

It's the details that count. Complete the chrome transformation by adding this finishing touch to your chrome fork sliders. This Axle Retainer Nut Kit includes the stylish chrome-plated nuts and chrome lockwashers necessary to replace the stock hardware.

45813-03 **\$27.95**
Fits '91-'05 FXDWG, '86-'07 FLST, FLSTC, FLSTF and FLSTN, '91-'07 FXST and FXSTB, and '84-'13 Touring and Trike models.

C. FORK SLIDER DRAIN SCREW KIT – CHROME

It's the details that count. Complete the chrome transformation by adding this finishing touch to your chrome fork sliders. This Fork Slider Drain Screw Kit includes two chrome-plated drain screws and the seals required to replace the stock hardware.

45848-03 **\$4.95**
Fits '93-'05 FXDWG, '87-'17 Softail (except Springer™, FXCW, FXCWC, FXSB, FXSBSE, FXSE and FXSTD) and '87-'13 Touring and Trike models.



B. FORK AXLE RETAINER NUT KIT – CHROME



C. FORK SLIDER DRAIN SCREW KIT – CHROME

D. BRAKE CALIPER INSERTS

Easy-to-install inserts add a finishing touch to the front and rear brake calipers. Select a style that follows your custom direction. Self-adhesive backing.

Fits '00-later front and rear brake calipers on all models (except Springer front, '06-later VRSC, '15-later XG, '04-'22 XL, '18-later Softail rear caliper, and '08-later Touring and Trike).

44477-99 Classic Chrome. **\$20.95**
44476-99 Harley-Davidson Script. **\$20.95**



D. BRAKE CALIPER INSERT – CLASSIC CHROME



D. BRAKE CALIPER INSERT – HARLEY-DAVIDSON SCRIPT



E. FRONT BRAKE CALIPER KIT – RED
(41300152 SHOWN)

E. BRAKE CALIPER KIT – RED

Dress your bike in the latest high-performance look. Brilliant red calipers make a powerful visual statement and set your bike apart from the ordinary. Manufactured from Original Equipment components for proven performance, these calipers will add a stylish touch to the stock bike or add the perfect finish to a complete custom equipped with chrome or blacked-out wheels, rotors and fork sliders.

41300152 Front – Single Disc. **\$266.95**
Fits '15-later Softail® models (except FXLRS, FXDRS, FXFB, FXFBS, FXSE). Kit includes brake pads.

F. BRAKE CALIPER KIT – CHROME

Add the shine of chrome to your front end with this highly polished Chrome Front Brake Caliper Kit. Manufactured from Original Equipment components for proven performance, these calipers are a great addition to the stock front end or add the finishing touch to a complete custom with chrome wheels, rotors and chrome fork sliders.

41300148 Front – Single Disc. **\$425.95**
Fits '15-later Softail models (except FXDRS, FXFB, FXFBS, FXSE). Kit includes brake pads.

44395-08 Front – Single Disc. **\$413.95**
Fits '08-'17 Dyna® (except FXDF, FXDLS and '14-'17 FXDL) and '08-'14 Softail models (except Springer) equipped with single disc front brakes. Brake pads sold separately.

44395-00A Front – Single Disc. **\$419.95**
Fits '00-'03 XL, '00-'07 Dyna and '00-'07 Softail models (except Springer™) equipped with single disc front brakes. Brake pads sold separately.

42047-08 Rear. **\$378.95**
Fits '08-'17 Dyna and Softail models. Brake pads sold separately.

Shown with:

REAR CALIPER BRACKET – CHROME

Complete a chrome rear brake conversion. This Rear Caliper Bracket sets your ride apart from the others by replacing the painted black mount with brilliant chrome. Manufactured from the Original Equipment components for exact fit, this mount will bolt to the existing mounting location.

42048-08 Fits '08-'17 Softail models. **\$142.95**

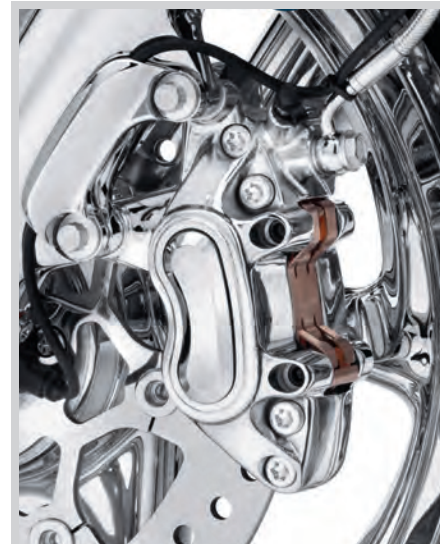

F. FRONT BRAKE CALIPER KIT – CHROME
(41300148 SHOWN WITH CLASSIC CHROME CALIPER INSERT)



F. FRONT BRAKE CALIPER KIT – CHROME
(44395-08 SHOWN WITH CLASSIC CHROME CALIPER INSERT)



F. FRONT BRAKE CALIPER KIT – CHROME
(41300148 SHOWN)



F. FRONT BRAKE CALIPER KIT – CHROME
(44395-08 SHOWN)



F. REAR BRAKE CALIPER KIT – CHROME
(SHOWN WITH CHROME REAR CALIPER BRACKET)

Notice: The prices appearing in this catalog are the manufacturer's suggested retail prices. Actual retail prices may vary.

Notice: The prices appearing in this catalog are the manufacturer's suggested retail prices. Actual retail prices may vary.

SOFTAIL

184 CRUISER

Chassis Trim – Rear End

A. CONTOURED FRAME INSERTS

These Contoured Frame Inserts are shaped to fill the frame recesses that surround the swingarm pivot bolt. Adhesive backed for easy installation.

48211-08 Chrome. **\$69.95**
Fits '08-'17 Softail® models (except FXCW, FXCWC, FXSB and FXSBSE).

48212-08 Chrome. **\$69.95**
Fits '08-'17 FXCW, FXCWC, FXSB and FXSBSE and '16-later FXSE models.

B. SOFTAIL® FRAME TRIM SET

These easy-to-install chrome-plated trim plates fit into the recesses at the rear of the Softail frame and add a bright finishing touch. To complete the look, add a set of chrome Swingarm Pivot Bolt Covers (sold separately).

47300-88T **\$31.95**

Fits '84-'17 Softail models (except '00-'17 FLSTF, FLSTFB, FLSTFBS, FLSTN, FLSTSB and FXSTD models equipped with shotgun exhaust).

C. SOFTAIL FRAME INSERT AND PIVOT BOLT KIT

Chrome rear frame inserts get you going on the road toward the perfect Softail. Kit includes Swingarm Pivot Bolt Covers and Frame Inserts. Easy installation kit.

48452-00 **\$44.95**
Fits '00-'07 FLSTF, FLSTN and FXSTD models. Does not fit FXSTDSE.

D. SWINGARM PIVOT BOLT COVERS

Cover your swingarm pivot bolt with distinctive styling. Available in your choice of mirror chrome or gloss black finish, this kit includes set screws and Allen® wrench for easy installation (sold in pairs).

Fits '08-'17 Softail® models (except FXCW, FXCWC, FXSB, FXSBSE, FXSE and FXST-Aus) and models equipped with Passenger Footboard Kits.

47660-09 Chrome – Die-cast. **\$35.95**

47612-08 Chrome – Billet. **\$47.95**

Fits '00-'07 Softail models (except FLSTF, FXSTD and models with Passenger Footboard Kit).

43462-00 Chrome – Die-cast. **\$38.95**

Fits '84-'99 Softail models (except FLSTS).

43897-86B Chrome – Die-cast. **\$38.95**

E. SWINGARM PIVOT BOLT COVERS – WILLIE G SKULL COLLECTION

The menacing raised skull with black-filled eyes leaps from a field of chrome. The surrounding Harley-Davidson Motorcycles script is the perfect finishing touch. This easy-to-install kit includes left and right pivot bolt covers and necessary mounting hardware.

47663-09 **\$38.95**

Fits '08-'17 Softail models (except FXCW, FXCWC, FXSB, FXSBSE, FXSE and FXST-Aus).

43235-08 **\$38.95**

Fits '00-'07 Softail models (except FLSTF, FXSTD and models with Passenger Footboard Kit).

F. SWINGARM PIVOT BOLT COVERS – HARLEY-DAVIDSON MOTOR CO. LOGO

Die-cast, chrome-plated with black Harley-Davidson Motor Co. logo. Includes set screws and Allen wrench for easy installation (sold in pairs).

47630-09 **\$38.95**

Fits '08-'17 Softail models (except FXCW, FXCWC, FXSB, FXSBSE, FXSE and FXST-Aus).

G. UPPER BELT GUARD – CHROME

Hand-polished and chrome-plated to replace your factory-equipped painted upper belt guard.

60867-08 **\$118.95**

Fits '07-'17 FLS, FLSS, FLSTFB, FLSTFBS, FLSTSB, FLSTSC, FXCW, FXS, FXSB, FXSE, FXST and FXSTB models. Stock on many '07-'17 Softail® models.



A. CONTOURED FRAME INSERTS

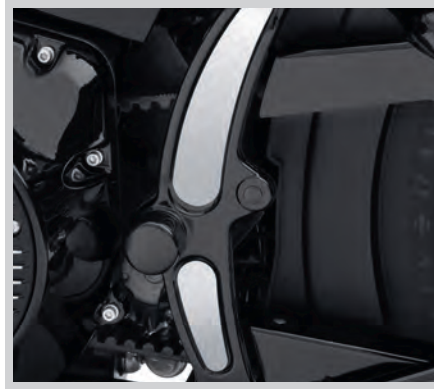

B. SOFTAIL FRAME TRIM SET

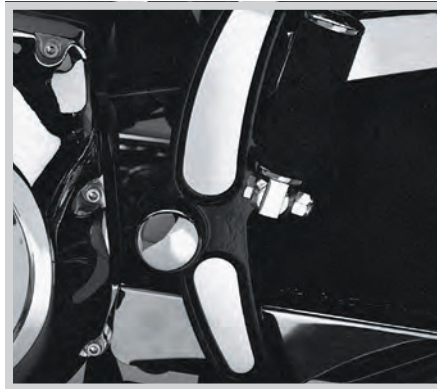

C. SOFTAIL FRAME INSERT AND PIVOT BOLT KIT



D. SWINGARM PIVOT BOLT COVERS – CHROME



E. SWINGARM PIVOT BOLT COVERS – WILLIE G SKULL COLLECTION



F. SWINGARM PIVOT BOLT COVERS – HARLEY-DAVIDSON MOTOR CO. LOGO



G. UPPER BELT GUARD – CHROME



H. LOWER BELT GUARD – CHROME (60654-07A SHOWN)



H. LOWER BELT GUARD – GLOSS BLACK (57100179 SHOWN)



I. REAR AXLE NUT COVERS – CHROME (44256-01 SHOWN)

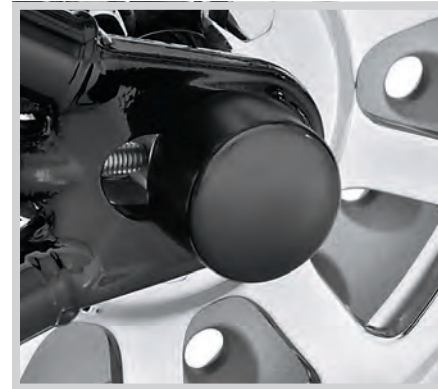

I. REAR AXLE NUT COVERS – GLOSS BLACK (43422-09 SHOWN)



I. REAR AXLE NUT COVERS – GLOSS BLACK (43000052 SHOWN)



J. REAR AXLE NUT COVERS – WILLIE G SKULL

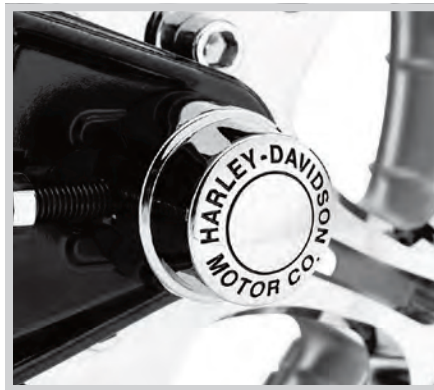

K. REAR AXLE NUT COVERS – H-D MOTOR CO. LOGO, CHROME



L. REAR AXLE NUT COVERS – H-D MOTOR CO. LOGO, GLOSS BLACK

CRUISER 185

Chassis Trim – Rear End

H. LOWER BELT GUARD

This handsome formed steel guard replaces the Original Equipment plastic debris deflector, providing a rich smooth surface that complements the swingarm and frame. Available in chrome or gloss black finish, this complete kit includes all required mounting hardware.

Fits '07-'17 FLS, FLSS, FLSTC, FLSTN, FLSTNSE, FXS, FXSB, FXSBSE, FXSE and FXSTD models.

60654-07A Chrome. **\$104.95**

57100179 Gloss Black. **\$108.95**

Fits '07-'17 FLSTF, FLSTFB, FLSTFBS, FLSTSB, FXST, FXSTB and FXSTC, '14-'15 FLSTNSE, '10-'12 FLSTSE, '16-'17 FXSE and '07-'08 FXSTSSE. Chrome version stock on '14-'15 FLSTNSE, '10-'12 FLSTSE and '07-'08 FXSTSSE models.

60655-07A Chrome. **\$104.95**

REAR AXLE NUT COVERS

Cover your rear axle nut in the most traditional way. These Rear Axle Cover Kits complement the matching Front Axle Nut covers. Easy to install, these cover kits include necessary mounting hardware. Sold in pairs.

I. REAR AXLE NUT COVERS

Fits '08-'17 Dyna® and '08-later Softail® models (except FXCW, FXCWC, FXSB, FXSBSE, FXSE, FXST-Aus, and '18-later FLFB, FLFBS, FLSB, FXBR, FXBRS and FXDRS).

41705-09 Chrome – Die-cast. **\$33.95**

43422-09 Gloss Black – Billet. **\$47.95**

Fits '00-'07 Softail models (except FLSTS and FLSTSC). (Will not fit with saddlebags.)

44256-01 Chrome – Die-cast. **\$33.95**

Fits '09-'11 FXCW and FXCWC, '13-'17 FXSB and FXSBSE, and '16-'17 FXSE models.

43000051 Chrome – Billet. **\$124.95**

43000052 Gloss Black – Billet. **\$124.95**

J. REAR AXLE NUT COVERS – WILLIE G SKULL

41706-09A **\$38.95**

Fits '08-'17 Dyna and '08-later Softail models (except FXCW, FXCWC, FXSB, FXSBSE, FXSE, FXST-Aus, and '18-later FLFB, FLFBS, FLSB, FXBR, FXBRS and FXDRS).

43221-08 **\$38.95**

Fits '00-'07 later Softail models.

K. REAR AXLE NUT COVERS – H-D MOTOR CO. LOGO, CHROME

41704-09 **\$35.95**

Fits '08-'17 Dyna and '08-later Softail models (except FXCW, FXCWC, FXSB, FXSBSE, FXSE, FXST-Aus, and '18-later FLFB, FLFBS, FLSB, FXBR, FXBRS and FXDRS).

L. REAR AXLE NUT COVERS – H-D MOTOR CO. LOGO, GLOSS BLACK

Cover the axle in style. Drenched in gloss black and trimmed with deep cut, silver-filled Harley-Davidson Motor Co. lettering, these Axle Nut Covers are an aggressive twist on a classic style. The covers look great with Original Equipment satin-finish fork sliders or are the perfect finishing touch to complete a blacked-out front or rear end. These easy-to-install kits include all necessary mounting hardware. Sold in pairs.

43000178 **\$37.95**

Fits '08-'17 Dyna and '08-later Softail models (except FXCW, FXCWC, FXSB, FXSBSE, FXSE, FXST-Aus, and '18-later FLFB, FLFBS, FLSB, FXBR, FXBRS and FXDRS).

186 CRUISER

Chassis Trim – Rear End

A. DOMINION™ COLLECTION REAR AXLE NUT COVERS

Express your bold, renegade attitude. The machined aluminum Dominion™ Collection Rear Axle Nut Covers add style to the front of the bike and are the perfect complement to other Dominion Collection accessories.

43000129 Gloss Black. **\$79.95**
Fits '08-'17 Dyna® and '08-later Softail® models (except FXCW, FXCWC, FXSB, FXSBSE, FXSE, FXST-AUS and '18-later FLFB, FLFBS, FLSB, FXBR, FXBRS and FXDRS).

B. BAR & SHIELD REAR AXLE COVERS

Add a sweep of chrome to the rear of the swingarm. This mirror-finished cover hides the axle head and the rear of the swingarm (sold in pairs).

42069-08 **\$118.95**
Fits '08-'17 Softail models (except FLSTF, FLSTFB, FLSTFBS, FXCW, FXCWC, FXSB, FXSBSE and FXSE). Will not fit with saddlebags.

44345-09 **\$107.95**
Fits '08-'11 FXCW and FXCWC models. Will not fit with saddlebags.

C. REAR AXLE COVERS – CHROME

Traditional wedge-shaped rear axle covers follow the triangular lines of the Softail swingarm and conceal the swingarm tail for a clean, custom look. This kit includes left and right covers, complementing trim discs and all required mounting hardware.

47596-91B **\$142.95**
Fits '87-'07 Softail models (except FLSTS). Will not fit with saddlebags.

D. REAR AXLE ADJUSTER HARDWARE – CHROME

Highly polished and chrome-plated hex-head bolts replace the standard hardware for a custom look. Manufactured to Original Equipment specifications to ensure fit and performance, this kit is the perfect addition to a chrome or painted swingarm.

41202-08 Fits '08-'17 Softail models. **\$16.95**



A. DOMINION REAR AXLE NUT COVERS – GLOSS BLACK



B. BAR & SHIELD REAR AXLE COVERS (42069-08 SHOWN)



B. BAR & SHIELD REAR AXLE COVERS (44345-09 SHOWN)

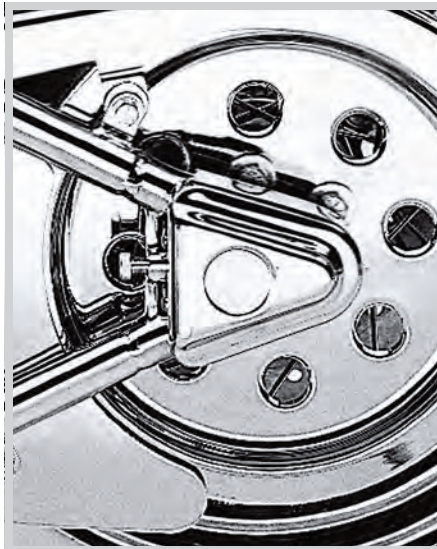

C. REAR AXLE COVERS – CHROME



D. REAR AXLE ADJUSTER HARDWARE – CHROME



E. BAR & SHIELD LOGO COIL COVER



F. VOLTAGE REGULATOR – CHROME



G. VOLTAGE REGULATOR COVER – CHROME



H. PREMIUM OIL COOLER KIT – '00-'17 SOFTAIL WITHOUT ABS CENTER MOUNT



H. PREMIUM OIL COOLER KIT – '11-'17 SOFTAIL WITH ABS SIDE MOUNT

CRUISER 187

Chassis Trim

E. BAR & SHIELD LOGO COIL COVER

Featuring a radical open-face design with a Bar & Shield logo silhouette, this chrome coil cover matches chrome Voltage Regulator Covers P/N 74597-01, for an integrated custom look. Includes all mounting hardware.

74616-04 **\$43.95**
Fits '04-'17 EFI Dyna® and '01-'17 EFI equipped Softail® models (except FXCW, FXCWC, FXS, FXSB, FXSBSE, FXSE, and FXST-Aus).

F. VOLTAGE REGULATOR – CHROME

Original Equipment voltage regulators with a sparkling triple-plated chrome finish. Hand-buffed, then copper-, nickel- and chrome-plated, these brilliant chrome-plated regulators are the perfect highlight for any Harley-Davidson® motorcycle.

74567-11 Fits '11-'17 Softail models. **\$180.95**

G. VOLTAGE REGULATOR COVER – CHROME

With a look that creates its own electricity, this chrome-plated cover features an embossed Bar & Shield logo and an open-center grill that allows air to flow right through for regulator cooling. Designed for easy installation. Chrome mounting hardware included.

74597-01 **\$53.95**
Fits '01-'17 Softail models (except FXSE). Will fit models equipped with Bullet Front Spoiler P/N 57039-XX. Will not fit with other Softail front spoilers.

H. PREMIUM OIL COOLER KITS

This oil cooler was designed specifically for Harley-Davidson to out-perform all other coolers in the industry. The cooler features a unique Turbulator system that evenly distributes oil across the cooling chambers. The air fins are designed to efficiently dissipate heat. The oil cooler has been designed to simplify installation and enhance performance. The large heat exchanger provides excellent cooling efficiency. The kit features a one-piece adapter plate with integrated thermostat that allows oil lines to connect to the oil filter bracket. Thermostat activates at 185°F (85°C). Kit comes complete with mounting hardware and precut oil lines.

26157-07A Center Mount. **\$460.95**
Fits '13-'17 FXSBSE and '00-'17 Softail models (except FXSB) without ABS. Does not fit '11 FXCWC, '08-'10 FXCW and FXCWC models require separate purchase of Horn Relocation Kit for Oil Cooler P/N 69015-08. Does not fit with Softail Front Spoiler Kits, or DEFINITIVE5 Filtration System Kits. Fits with all H-D® Engine Guards. Includes Chrome Oil Cooler Cover.

26157-11A Side Mount. **\$460.95**
Fits '11-'17 Softail models. Fits with all H-D Engine Guards. Kit includes Gloss Black Oil Cooler Cover.

Notice: The prices appearing in this catalog are the manufacturer's suggested retail prices. Actual retail prices may vary.

Notice: The prices appearing in this catalog are the manufacturer's suggested retail prices. Actual retail prices may vary.

SOFTAIL

188 CRUISER

Chassis Trim – Fenders

A. FRONT FENDER TRIM

Add a sweeping dash of chrome to the front fender. Chrome-plated tapered spear features a stepped design that accentuates the flowing fender lines. Self-adhesive backing simplifies installation.

14100618 **\$49.95**
Fits '12-'16 FLD, '86-'17 FL Softail® (except FLSTSB), '18-later Softail FLDE, FLHC and FLHCS, '84-later Touring and Trike models.

B. BAR & SHIELD LOGO FRONT FENDER SPEAR

This chrome-plated trim spear adds a sweeping dash of chrome to the front fender. Featuring a raised Bar & Shield logo set against a textured black field, this self-adhesive medallion is easy to install.

91195-04 Large. **\$48.95**
Fits '12-'16 FLD, '86-'17 FL Softail (except FLSTSB), '18-later Softail FLDE, FLHC and FLHCS, '84-later Touring and Trike models.

91194-04 Small. **\$43.95**
Fits XL, XR, Dyna® (except FLD), FX Softail (except FXFB) and '18-later FLSTL models.

C. CONCHO FENDER SKIRT

This decorative fender skirt features conchos inspired by the Heritage Softail® Classic model.

59147-96 **\$64.95**
Fits '06 FLST, '86-'08 FLSTC, '93-'96 FLSTN, '80-'13 Touring and '09-'13 Trike models equipped with Original Equipment fender skirt.

D. WILLIE G SKULL FENDER SKIRT

This decorative chrome-plated fender skirt is a direct replacement for stock fender skirt. Features a three-dimensional sculptured concho with skull design set off with black accents. Mounting hardware included.

59582-02A **\$64.95**
Fits '06 FLST, '86-'08 FLSTC, '93-'96 FLSTN, '80-'13 Touring and '09-'13 Trike models equipped with Original Equipment fender skirt.

E. BAR & SHIELD FENDER SKIRT

This rigid-steel fender skirt, designed to replace the original factory-equipped aluminum trim, is formed, polished and chrome-plated. Its ribbed pattern offers a unique styling element and adds rigidity. Subtle but distinctive brushed aluminum Bar & Shield logos are framed by a stamped-in ribbed outline on both sides.

59228-91 **\$64.95**
Fits '06 FLST, '86-'08 FLSTC, '93-'96 FLSTN, '80-'13 Touring and '09-'13 Trike models equipped with Original Equipment fender skirt.

F. FRONT FENDER EXTENSION – CHROME

Dress your front fender in chrome. This chrome-plated tapered Fender Extension is shaped to follow the curve of the fender for style and function. Using the Original Equipment fender hole, the extension mounts below the trailing edge of the fender to help control road dirt and spray.

59664-03 **\$54.95**
Fits '91-'08 Dyna and '84-'07 FX Softail models. (Will not fit FXD, FXDX or FXDXT models equipped with Voltage Regulator Covers.)



A. FRONT FENDER TRIM



B. BAR & SHIELD LOGO FRONT FENDER SPEAR (LARGE SHOWN)



B. BAR & SHIELD LOGO FRONT FENDER SPEAR (SMALL SHOWN)



C. CONCHO FENDER SKIRT



D. WILLIE G SKULL FENDER SKIRT



E. BAR & SHIELD FENDER SKIRT



F. FRONT FENDER EXTENSION – CHROME



G. FRONT FENDER TRIM KIT – CHROME



I. BAR & SHIELD LOGO FENDER TIP LENS KIT



K. EAGLE WING FENDER TRIM FOR FAT BOY MODELS



M. HERITAGE REAR FENDER RAIL – CHROME



H. FENDER TIP LENS KIT WITH SKULL LOGO



J. H-D CLASSIC FENDER TIP



L. HERITAGE FRONT FENDER RAIL – CHROME



N. HERITAGE SPRINGER LEATHER MUD FLAP WITH FRINGE

CRUISER 189

Chassis Trim – Fenders

G. FRONT FENDER TRIM KIT – CHROME

Replace the Original Equipment stainless steel fender trim with a splash of chrome. Kit includes left and right side trim strip.

59209-91T **\$33.95**
Fits '86-'17 FLSTC and FLSTN and '82-'13 Touring models (except Road Glide® and Road King® Custom). Does not fit models equipped with clean front fender.

H. FENDER TIP LENS KIT WITH SKULL LOGO

This chrome-plated fender tip lens kit adds a little attitude to your ride. The kit features front and rear lenses with a translucent illuminated skull silhouette. The easy-to-install kit includes an amber front lens and red rear lens.

59651-01 **\$33.95**
Fits '86-'17 FLSTC, '93-'96 FLSTN and '80-'08 Electra Glide®, Tour Glide and Road King® models (except FLHRC and FLHRS).

I. BAR & SHIELD LOGO FENDER TIP LENS KIT

Chrome-plated polycarbonate construction features translucent Bar & Shield emblems. The kit includes front and rear lenses. Front lens features an amber Bar & Shield logo, rear lens features a red Bar & Shield logo. Quick and easy installation.

59081-96 Front and Rear. **\$33.95**
Fits '86-'17 FLSTC, '93-'96 FLSTN and '80-'08 FLHR, FLHS, FLHT and FLT models. (Does not fit Springer™, FLHRS or FLTR.)

J. H-D® CLASSIC FENDER TIP

Stock on Road King Classic models, these nostalgic-look fender tips are also available for other models. Replaces fender lamp assembly.

59002-98 Front. **\$58.95**
Fits '80-'13 FL, '86-'08 FLSTC, '94-'13 FLHR and '09-'13 FLHTCUTG models.

59052-98 Rear. **\$35.95**
Fits '80-'08 FL and FLHR models and '86-'99 FLSTC models. (Does not fit FLSTF and FLTR models.)

K. EAGLE WING FENDER TRIM FOR FAT BOY® MODELS

Classic Eagle Wing logo in gold & chrome with black accent. Matches Eagle Wing headlamp, tail lamp and turn signal visors.

Fits '90-'06 FLSTF models.
59369-97 Rear, Gold & Chrome. **\$39.95**

L. HERITAGE FRONT FENDER RAIL – CHROME*

A stylish re-creation of a popular Hydra Glide model accessory direct from the Harley-Davidson® 1959 accessories catalog. Ornate, jet, twin-tube design sweeps smartly back along the front fender. Sparkling chrome-plating and years-ahead styling make it a hit for all Heritage and FLSTN owners.

91080-93 **\$107.95**
Fits '87-'17 FLST, FLSTC and '93-'96 FLSTN models. (Does not fit Springer™ models.)

M. HERITAGE REAR FENDER RAIL – CHROME*

A perfect match to Heritage Chrome Front Fender Rail P/N 91080-93. Designed to fit with stock FLSTC, FLSTN saddlebags or Genuine Harley-Davidson® Fat Boy® leather saddlebags.

91402-00 **\$107.95**
Fits '00-'17 FLST and FLSTC models.

N. HERITAGE SPRINGER™ LEATHER MUD FLAP WITH FRINGE

Made from premium, plated leather with black trim, these flaps have fringe and an '97-'03 FLSTS concho and black trim. Includes chrome hardware, support bracket and fender mounting template.

59027-99 **\$64.95**
Fits '97-'03 FLSTS models front or rear fender. Also fits '86-'17 FLSTC, '86-'06 FLSTF and '93-'96 FLSTN models.



***WARNING:** Fender rails are decorative items only. Do not strap anything to the rails. Adding weight to the front fender could adversely affect vehicle handling, causing loss of control and death or serious injury.



***WARNING:** Fender rails are decorative items only. Do not strap anything to the rails. Adding weight to the front fender could adversely affect vehicle handling, causing loss of control and death or serious injury.

Notice: The prices appearing in this catalog are the manufacturer's suggested retail prices. Actual retail prices may vary.

Notice: The prices appearing in this catalog are the manufacturer's suggested retail prices. Actual retail prices may vary.

SOFTAIL



Universal Phone Carrier

582

HARLEY-DAVIDSON® GRAND AMERICAN TOURING - FLHRXS

ROAD KING SPECIAL

Roll with soul, or rock 'n roll. Secure your phone in our vibration-damping Universal Phone Carrier and stream your tunes through Harley-Davidson® Audio powered by Rockford Fosgate® Amp Kit and Stage II Saddlebag Lid Speakers. H-D Prodigy 19-inch Wheels in Gloss Black are a style power chord.



H-D Prodigy 19-inch Front Wheel

636



Endgame Collection Foot Controls

478



H-D Audio powered by Rockford Fosgate - Stage II Saddlebag Lid Speakers

550



Color-Matched Fairing Lowers

667

HARLEY-DAVIDSON® GRAND AMERICAN TOURING - FLTRX

ROAD GLIDE

Combine the chest thumping bass of a Harley-Davidson® Audio powered by Rockford Fosgate® Subwoofer Kit with two Stage II speakers for audio with authority. Color-Matched Fairing Lowers and a Low-Profile Solo Seat and Passenger Pillion add custom comfort. Crank it up. They'll hear you coming.



Low-Profile Solo Touring Seat and Passenger Pillion

248



H-D Audio powered by Rockford Fosgate - Subwoofer

555



Air Wing H-D® Detachables™ Two-Up Luggage Rack

262



Black Rubber Heated Hand Grips

499



Harley Hammock Heated & Cooled Seat

243



Black Heel Shifter

283



Color-Matched Chopped Tour-Pak Luggage

672

HARLEY-DAVIDSON® GRAND AMERICAN TOURING - FLTRXS

ROAD GLIDE SPECIAL ANNIVERSARY EDITION

Celebrate in style. A detachable Chopped Tour-Pak® is finished in a perfect color match for the intricate 120th Anniversary paint. To extend the season, we've added Heated Hand Grips and the ultimate in riding comfort, a Harley® Hammock Heated & Cooled Seat. You've got the best seat in the house.



Screamin' Eagle 131CI Stage IV Kit

360



Screamin' Eagle/Öhlins Remote Reservoir Rear Shocks

290



Screamin' Eagle Derby Cover

369



Endgame Collection Foot Controls

478

HARLEY-DAVIDSON® GRAND AMERICAN TOURING - FLTRXST

ROAD GLIDE® ST

Experience unrelenting power from a Screamin' Eagle® 131 Stage IV Kit inhaling through a Heavy Breather Elite Air Cleaner. Screamin' Eagle/Öhlins® Remote Reservoir Rear Shocks tighten up the ride and the handling and look the business. Endgame Collection accessories add industrial attitude. Twist throttle and shout, indeed.



Wind Splitter 7-inch Windshield

222

HARLEY-DAVIDSON® GRAND AMERICAN TOURING - FLHX

STREET GLIDE

No passenger, no problem. Pair a solo brawler seat with Chopped Tour-Pak® Luggage for added comfort and capacity. Adversary™ Collection accessories in gray and a Color-Matched Chin Spoiler add understated style. Experience effective airflow and wow styling behind the 7-inch Windshield. Gas up and leave your troubles behind.



Color-Matched Chopped Tour-Pak Luggage

672



Adversary Collection Rider Footboards

469

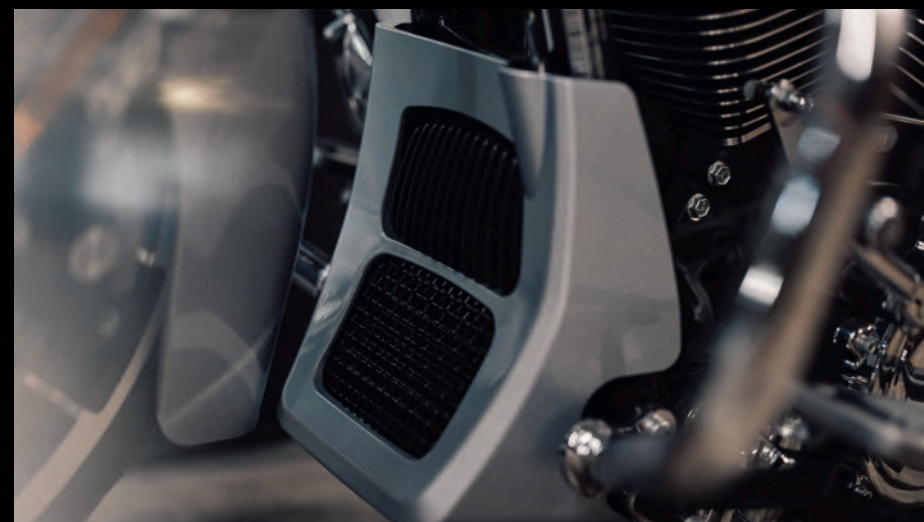

Color-Matched Chin Spoiler

666



Screamin' Eagle/Öhlins Remote Reservoir Rear Shocks

290



Color-Matched Custom Wrapped Front Fender

664



80Grit Rider Footpegs

477



Badlander Seat

247

HARLEY-DAVIDSON® GRAND AMERICAN TOURING - FLHXS

STREET GLIDE SPECIAL

Catch yellow fever. Color-Matched Custom Wrapped Front Fenders take this color combo over the top. Grippy 80Grit™ Rider Footpegs replace those old-school footboards. The popular Badlander® Seat delivers a low and lean custom look. Ride it like a racer with adjustable Screamin' Eagle®/Öhlins™ Remote Reservoir Rear Shocks.



Fused Handlebar

536

HARLEY-DAVIDSON® GRAND AMERICAN TOURING - FLHXST

STREET GLIDE ST

Ride amped up. Turn on the tunes with Harley-Davidson® Audio powered by Rockford Fosgate® Stage II Fairing Speakers. Get your hands up on a Fused Handlebar. Emphasize the long and lean look of the fuel tank with the Flush Mount Fuel Cap. Put your feet up on Dominion™ Rider Footboards. It's up to you.



Flush Mount Fuel Cap

591



Dominion Collection Rider Footboards

480



H-D Audio powered by Rockford Fosgate - Stage II Fairing Speakers

549

STREET GLIDE® ST

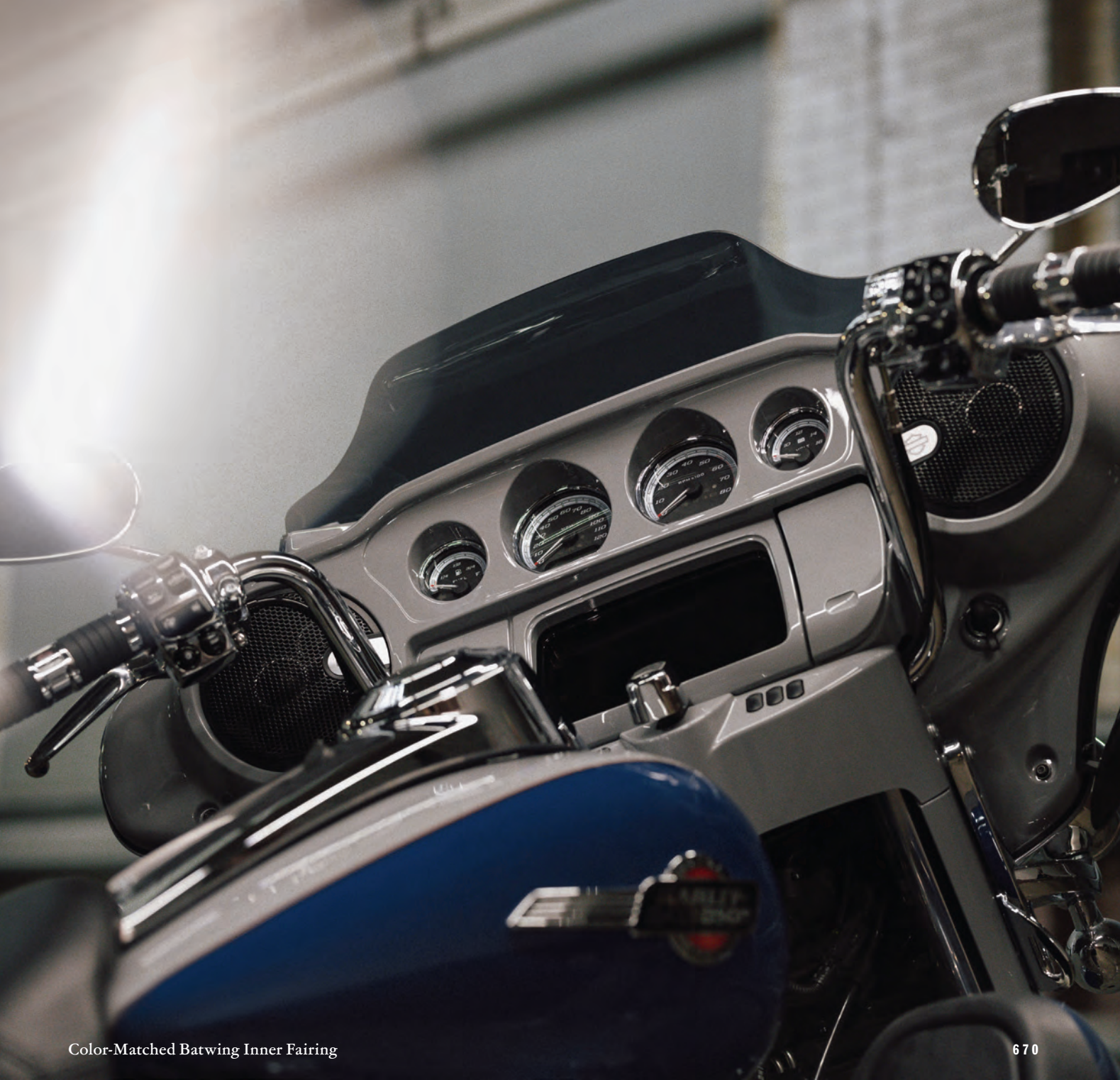

Color-Matched Batwing Inner Fairing

670

HARLEY-DAVIDSON® GRAND AMERICAN TOURING - FLHTK

ULTRA LIMITED

We dressed up this two-up, two-tone beauty with a Color-Matched Batwing Inner Fairing Kit, Chrome Switch Housings and a Stealth Tour-Pak® Luggage Rack. The miles will fly by in any season with comfort dialed in for rider and passenger on a Harley® Hammock Heated & Cooled Seat. She's a long-haul looker.



Chrome Switch Housing Kit

512



Stealth Tour-Pak Luggage Rack

270



Harley Hammock Touring Seat with Rider Backrest

243



Road Glide 15-inch Wind Splitter Windshield

228

HARLEY-DAVIDSON® GRAND AMERICAN TOURING - FLTRK

ROAD GLIDE LIMITED

Devour the miles in comfort and stunning style. The Road Glide 15-inch Wind Splitter Windshield creates a calm cockpit. Gloss Black H-D® Prodigy™ Custom Wheels and Kahuna™ Collection accessories show the world you can tour with class. Amplify your experience with H-D® Audio powered by Rockford Fosgate® Stage I Saddlebag Lid Speakers.



H-D Audio powered by Rockford Fosgate - Stage I Saddlebag Lid Speakers

550



Kahuna Rider Footboard Kit

488



H-D Prodigy Custom Wheel

636

ROAD GLIDE® LIMITED



HARLEY-DAVIDSON® TRIKE - FLTRT

ROAD GLIDE 3

Custom details define the personality of the ride and rider. The look of precision is expressed by Machine Cut Empire™ Collection Derby Cover and Dominion™ Collection Foot Controls. A Road Glide® 4-inch Low-Profile Windscreen speaks to performance. Where will your custom journey lead?



Empire Collection Derby Cover

429



Dominion Collection Foot Controls

480



Road Glide 4-inch Low-Profile Windscreen

229



H-D Detachable 16-inch Windshield

221

HARLEY-DAVIDSON® TRIKE - FLRT

FREEWHEELER

Here's a trike with extra attitude. Red trim on a Milwaukee-Eight® Engine. Menacing Willie G Skull accessories. Gloss Black Air Wing Luggage Rack and the H-D® Detachable™ 16-inch Windshield — giving you the freedom to define your ride at the drop of a hat.



Milwaukee-Eight Red Engine Trim

442



Willie G Skull Collection Foot Controls

484



Air Wing Luggage Rack

254

FREEWHEELER®



Tomahawk Custom Wheels

637

HARLEY-DAVIDSON® TRIKE - FLHTCUTG

TRI GLIDE ULTRA

Gobble up the miles with class. The increased diameter and open design of Tomahawk™ Custom Wheels lighten this trike's profile. Harley-Davidson® Audio powered by Rockford Fosgate® provides crisp accompaniment. The elegant Get-A-Grip™ Hand Grips provide a positive connection to the controls. You've gone this far, why stop riding?



H-D Audio powered by Rockford Fosgate - Stage II Tour-Pak Speakers

551



Get-A-Grip Hand Grips

497



Airflow Collection Foot Controls

491

LONG-HAUL PACKAGE - TOURING

Kickstart your customization journey and make it as seamless as possible with the Long-Haul Custom Package from H-D® Genuine Parts & Accessories. Head for the horizon, with everything you need to convert a Street Glide®, Road Glide® or Road King® model into a cross-country touring bike, with a seat and grips ready for any climate, the ability to quickly add luggage capacity and more. Includes: H-D® Detachables Two-Up Tour-Pak® Mounting Rack, Tour-Pak Backrest Pad, Mid-Frame Air Deflectors, Harley Hammock Heated & Cooled Seat, Heated Hand Grips, Heel Shifter. Requires separate purchase of Color-matched King or Chopped Tour-Pak, Backrest Pad, and Lock Kit.

Available exclusively in Dealerships – See your Dealer for details.

50700086 – Black. \$1,990.95

50700085 – Chrome. \$1,990.95

Fits '17-later FLHR, FLHRXS, FLHX, FLHXS, FLHXST, FLTRX, FLTRXS, and FLTRXST models with Original Equipment Stainless Steel handlebars. Requires separate purchase of Color-matched King or Chopped Tour-Pak, Backrest Pad, and Lock Kit. Street Glide® and Road Glide® models require Hidden AM/FM/WB Antenna P/N 76000513 or Antenna Relocation Kit P/N 76000582. Does not work with Boom!™ Audio Stage II Tour-Pak® Speaker Kit P/N 76000526A. Heel Shifter is stock on '17-'19 Touring models.



Heated Hand Grips Tour-Pak Mounting Rack



Heated & Cooled Seat Heel Shifter



Notice: Shown with Color-Matched Tour-Pak and Backrest Pad (sold separately). Some Kit items not shown: Tour-Pak Back Rest Pad, 4-Point Docking Hardware and Mid-Frame Air Deflectors. Kit may include additional components required for complete installation.

EMPIRE™ PACKAGE - TOURING

Kickstart your customization journey and make it as seamless as possible with the Empire™ Custom Package from H-D® Genuine Parts & Accessories. The perfect balance of bagger performance and style for the rider who wants a little extra of both. Includes: Screamin' Eagle® Stage I Powertrain Upgrade, Low-Profile Touring Seat, Empire™ Collection hand and foot controls, footboards and derby cover.

Available exclusively in Dealerships – See your Dealer for details.

50700088 – Black. \$3,499.95

50700089 – Machine Cut. \$3,267.95

Fits '17-later FLHR, FLHRXS, FLHX, FLHXS, FLHXST, FLTRX, FLTRXS, and FLTRXST models. Not for use with Ergo Jiffy Stand P/N 50000091 or Jiffy Stand Extension Kit P/N 50233-00, 50000008 or 50000023. All models require ECM calibration with Screamin' Eagle Pro Street Tuner for proper installation. Does not fit on models equipped with fairing lower glove boxes or fairing lower speakers.



Notice: Some Kit items not shown: Empire Collection – Foot Controls. Kit may include additional components required for complete installation.



Low-Profile Touring Seat Street Cannon Mufflers Empire Hand Controls



Empire Footboards Powertrain Upgrade Empire Derby Cover



Heated Hand Grips Tour-Pak Mounting Rack 4-Point Docking Hardware

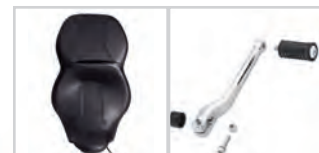

Heated & Cooled Seat Heel Shifter

Notice: Shown with Color-Matched Tour-Pak (sold separately). Some Kit items not shown: Tour-Pak Back Rest Pad and Mid-Frame Air Deflectors. Kit may include additional components required for complete installation. The prices appearing in this catalog are the manufacturer's suggested retail prices. Actual retail prices may vary.



Low-Profile Touring Seat Street Cannon Mufflers Empire Hand Controls



Empire Footboards Powertrain Upgrade Empire Derby Cover

Notice: Some Kit items not shown: Empire Collection – Foot Controls. Kit may include additional components required for complete installation. The prices appearing in this catalog are the manufacturer's suggested retail prices. Actual retail prices may vary.



216 TOURING

Packages

A. RIDER ESSENTIALS PACKAGE

Customization starts here. This Rider Essentials Package includes foundational accessories for select Touring models from H-D® Genuine Parts & Accessories, items to enhance the ride and enable the addition of luggage and rack options. Includes: 4-Point Docking Hardware Kit, Docking Hardware Cover Kit, Heel Shifter, Mid-Frame Air Deflectors, H-D® Smart Security System Fob.

Available in Dealerships or order on line at H-D.com.

50700113	Chrome.	\$482.95
50700112	Black.	\$482.95

Fits '17-later FLHR, FLHRXS, FLHX, FLHXS, FLHXST, FLTRX, FLTRXS, and FLTRXST models equipped with H-D® Smart Security System. Does not fit Japan models. Dealer installation required.



A. RIDER ESSENTIALS PACKAGE - CHROME



A. RIDER ESSENTIALS PACKAGE - BLACK



B. DAY-TRIPPER ESSENTIALS PACKAGE - CHROME



B. DAY-TRIPPER ESSENTIALS PACKAGE - BLACK



C. ST ESSENTIALS PACKAGE

TOURING 217

Packages

B. DAY-TRIPPER ESSENTIALS PACKAGE

Ideal for the weekend tour or the week-day commute. This Day-Tripper Package includes functional accessories for select Touring models from H-D® Genuine Parts & Accessories selected to offer quick-change versatility.

Includes: H-D® Detachables™ Sissy Bar Upright, Mid-size passenger backrest pad, Air Wing H-D Detachables Two-Up Luggage Rack, Onyx™ Premium Luggage Day Bag.

Available in Dealerships or order online at H-D.com. Package may include additional components not pictured.

50700111	Chrome	\$614.95
50700110	Black.	\$614.95

Fits '17-later FLHR, FLHRXS, FLHX, FLHXS, FLHXST, FLTRX, FLTRXS, and FLTRXST models. Requires separate purchase of 4-Point Docking Hardware Kit P/N 52300353 or 52300354 or Rider Essentials Accessory Package P/N 50700113 or 50700112. FLHX, FLHXS, FLHXST, FLTRX, FLTRXS and FLTRXST models require Hidden AM/FM/WB Antenna P/N 76000513 or Antenna Relocation Kit P/N 76000582. Backrest Pad height 8.0"; width 12.0".

C. ST ESSENTIALS PACKAGE

The two-up solution. This ST Essentials Package from H-D® Genuine Parts & Accessories is designed to make it easy to add passenger accommodations to the high-performance Street Glide® ST and Road Glide® ST models. Share the fun.

Includes: Low-Profile Leather Bucket Seat, 4-Point Docking Hardware Kit, H-D® Detachables™ Sissy Bar Upright Short, Compact Backrest Pad, Pillion Screw, Passenger Peg Supports, Streamliner Passenger Pegs.

Available in Dealerships only.

Fits '21-later FLHXST and FLTRXST models. Seat width 15.0"; passenger pillion width 8.5".

50700109		\$1,193.95
-----------------	--	-------------------

DEFY THE WIND

At highway speed, you take the wind full-force in the chest, causing fatigue in your arms, neck and shoulders.

Take the pressure off with an easy-to-install detachable windshield.

Shaped to divert air, rain and road debris around the rider, a windshield can add hours of riding comfort.

EXTENDED COVERAGE

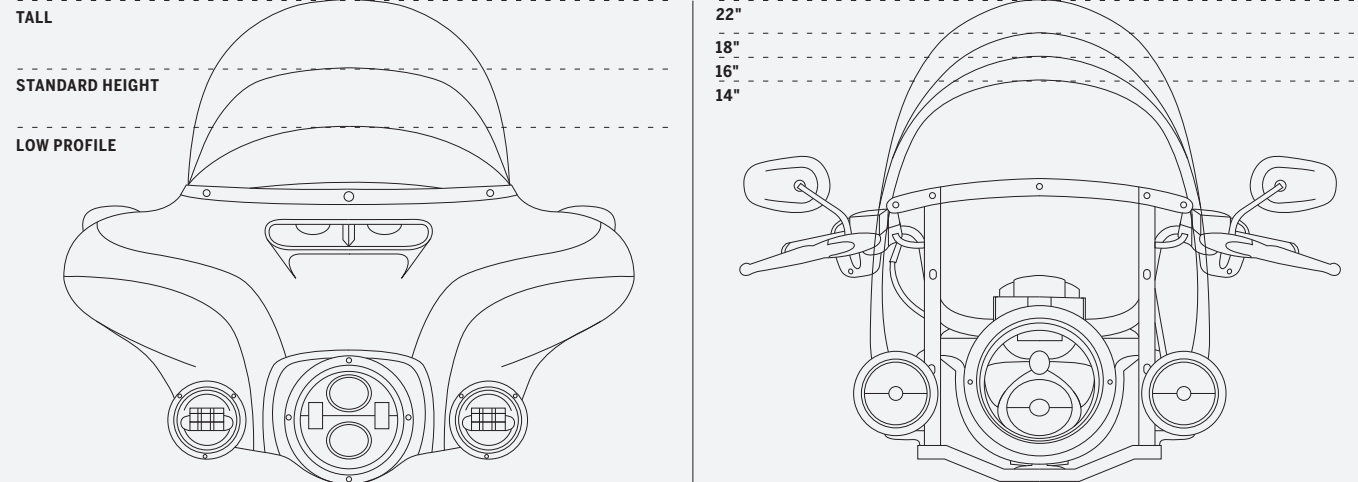

WIND SPLITTER

Wind Splitter windshields are shaped for effective airflow management and wow styling. The sweeping design adds height over a traditional low-profile wind deflector in the center where it counts.



To avoid looking through bug spots, condensation and road grime, select a windshield that tops out just below your line of sight.



A. H-D DETACHABLES WINDSHIELD – POLISHED BRACES



A. H-D DETACHABLES WINDSHIELD – BLACK BRACES

Windshields – Road King®

A. H-D® DETACHABLES™ WINDSHIELDS – ROAD KING® MODELS

Designed to be installed or removed without tools in seconds, a detachable windshield gives you the freedom to define your ride at the drop of a hat. Ride across the country protected from the elements, then quickly remove the windshield to hit the streets in style. These one-piece windshields are formed from hard-coated polycarbonate material to resist scratching and the complete assembly features polished stainless steel brackets that mount to the Original Equipment rubber isolated docking points for ease of installation and removal. Windshields are available in a variety of heights to match your size and riding style.

Fits '94-later Road King® models. '04-'07 FLHRS and '17-later FLHRXS models require additional purchase of Mounting Hardware Kit P/N 58221-04.

57995-96A	22" Clear – Polished.	\$359.95
Windshield dimensions: Overall height – 29.0"; width – 23.1".		
58325-06A	18" Clear – Polished.	\$339.95
Windshield dimensions: Overall height – 25.0"; width – 23.1".		
57981-97	16" Light Smoke – Polished.	\$380.95
Windshield dimensions: Overall height – 23.0"; width – 23.1".		
57400380	20" Clear – Black.	\$396.95
Windshield dimensions: Overall height – 27.2"; width – 23.1".		
57400381	18" Clear – Black.	\$396.95
Windshield dimensions: Overall height – 25.0"; width – 23.1".		
57400383	16" Light Smoke – Black.	\$401.95
Windshield dimensions: Overall height – 23.0"; width – 23.1".		

Also available:

ROAD KING WINDSHIELD DOCKING HARDWARE KIT
Kit includes the hardware required to install a H-D® Detachables™ Road King Windshield on the Road King Custom and Special models.

58221-04	Fits '04-later FLHRS and '17-later FLHRXS models.	\$34.95
-----------------	---	----------------

Also available:

REPLACEMENT WINDSHIELD SCREEN
Formed of polycarbonate and available in a size that suits your riding needs. Kit includes screen, cross brace tape and instructions.

Fits '94-later Road King models (except '13-'14 FLHRSE).

58433-96	22" Clear.	\$168.95
58135-94	20" Light Smoke.	\$184.95
58195-94	16" Light Smoke.	\$163.95

Notice: The prices appearing in this catalog are the manufacturer's suggested retail prices. Actual retail prices may vary.

220 TOURING & TRIKE

Windshields — Road King®

A. WIND SPLITTER VENTED WINDSHIELD

Reduce helmet buffeting at speed. The Harley-Davidson® Detachables™ Wind Splitter Vented Windshield features an exclusive fingertip-adjustable center vent that reduces turbulence behind the windscreen. When open, the controlled airflow fills the negative pressure area behind the shield and helps to smooth the flow of air over the top of the screen and around the rider. The revised flow reduces helmet bobbing and neck fatigue so you can comfortably spend more time in the saddle. The open vent also provides cooling airflow to the rider at low speeds and in city traffic.

Engineered to provide the riding comfort of a larger windshield, this low-profile screen's contemporary contour sets it apart from the crowd. The shape keeps the windshield below your sight line so you don't look through bugs and road grime and the detachable design means you can ride without the shield when the mood strikes. The shield is formed of hard-coated polycarbonate for strength and scratch resistance and the dark-smoked finish reduces glare. The slim polished stainless steel brackets mount to the Original Equipment rubber isolated docking points for ease of installation and removal.

57400176 \$470.95

Fits '94-later Road King® models (except FLHRS). '17-later FLHRXS models require additional purchase of Mounting Hardware Kit P/N 58221-04. Does not fit with Mini Tach or Boom!™ Audio Cruiser Speakers Stock on '13-'14 FLHRSE. Windshield dimensions: Overall height – 22.4" height from headlamp opening –16.1", width – 20.3".



A. WIND SPLITTER VENTED WINDSHIELD

B. ROAD KING® 14" H-D® DETACHABLES™ WIND DEFLECTOR

Maintain the same low-down mini-shield styling of the Road King® Dark Smoke Wind Deflector with a little extra wind protection. This 3.0" taller oversized dark smoke screen features polished stainless steel mounting brackets to provide the same ease of installation as the stock Road King windshield.

57357-07 14" Dark Smoke. \$385.95

Fits '94-later Road King models. '04-'07 FLHRS and '17-later FLHRXS models require additional purchase of Mounting Hardware Kit P/N 58221-04. Stock on '07 FLHRSE models. Windshield dimensions: Overall height – 21.0"; width – 21.4".

Also available:

ROAD KING 11" H-D DETACHABLES WIND DEFLECTOR

Keep the wind and glare out of your eyes with this Smoked Wind Deflector. This dark smoke detachable mini-shield follows the form of a traditional Harley-Davidson® Road King® windshield, but its much smaller size adds a touch of low-down attitude.

58163-02 11" Dark Smoke. \$364.95

Fits '94-later Road King models. '04-'07 FLHRS and '17-later FLHRXS models require additional purchase of Mounting Hardware Kit P/N 58221-04. Stock on '08 FLHRSE models. Windshield dimensions: Overall height – 18.0"; width – 19.4".



B. ROAD KING 14" H-D DETACHABLES WIND DEFLECTOR



C. H-D DETACHABLES WINDSHIELD – FREEWHEELER MODELS



D. FORK-MOUNT WIND DEFLECTORS – CHROME

TOURING & TRIKE 221

Windshields — Freewheeler®

C. H-D® DETACHABLES™ WINDSHIELDS – FREEWHEELER® MODELS

Designed to be installed or removed without tools in seconds, a detachable windshield gives you the freedom to define your ride at the drop of a hat. Ride across the country protected from the elements, then quickly remove the windshield to hit the streets in style. These one-piece windshields are formed from hard-coated polycarbonate material to resist scratching and the complete assembly features polished stainless steel or Gloss Black brackets that mount to rubber isolated docking points for ease of installation and removal. Windshields are available in a variety of heights to match your size and riding style.

Fits '15-later FLRT models.

57400273A 20" Clear – Polished. \$384.95

Windshield dimensions: Overall height – 25.5"; width – 22.2".

57400274 16" Light Smoke – Polished. \$390.95

Windshield dimensions: Overall height – 21.5"; width – 21.4".

57400630 16" Light Smoke – Gloss Black. \$399.95

Windshield dimensions: Overall height – 21.5"; width – 21.4".

57400631 20" Clear – Gloss Black. \$399.95

Windshield dimensions: Overall height – 25.5"; width – 22.2".

D. FORK-MOUNT WIND DEFLECTORS – CHROME

Dress your bike for comfort and style. Wind Deflectors extend the windshield's coverage for superior protection in any weather. The scooped Deflectors are shaped to channel the airflow and direct the rush of air and turbulence around the rider. Deflectors attach to the fork brackets for a clean, integrated look and the chrome finish is the perfect complement to polished or chrome front end components. Easy-to-install kit includes all required mounting hardware.

57400146A \$116.95

Fits '95-later FLHR, FLHRC and FLHRS and '14-later FLHRSE models. Also fits '06-'13 FLHT, FLHTC, '06-later FLHX and FLHXS, '19-later FLHT, '20-later FLHXSE, '22-later FLHXST and '19-later FLHT models. Does not fit '95-'13 models equipped with Lighted Fork Slider Kit or Custom Auxiliary Lighting Bracket Kit P/N 69227-04A or 68000043.

222 TOURING & TRIKE

Windshields — Electra Glide®

A. WIND SPLITTER WINDSHIELD – BATWING FAIRING

In the world of functional performance, size does matter. After all, it's simple to understand that the larger the windshield area, the greater the amount of wind deflection. The Wind Splitter Windshield is a great look for all Touring models and is shaped for the perfect combination of effective airflow management and "wow" styling. The sweeping design complements the shape of the fairing and the inner dash panel and adds height over a traditional low-profile wind deflector in the center where it counts. The shape decreases wind noise and improves your ability to hear the motorcycle's sound system. The rich smoked finish does not interfere with your forward view and looks great against any paint color. The easy-to-install Wind Splitter features a center-mount Bar & Shield medallion for a distinctive finishing touch.

Fits '14-later Electra Glide®, Street Glide®, Ultra Limited and Tri Glide® models.

57400204 4.5" Dark Smoke. **\$173.95**
Does not fit with Windshield Bags or Pouches.

57400205 7" Dark Smoke. **\$184.95**
Does not fit with Windshield Bags or Pouches.

57400206 10" Light Smoke. **\$184.95**

Fits '96-'13 Electra Glide, Street Glide and Trike models. Does not fit with fairing mounted zūmo® GPS Navigator, Windshield Bags or Pouches.

57400091 4.5" Dark Smoke. **\$173.95**

57164-10 7" Dark Smoke. **\$184.95**

57400092 10" Light Smoke. **\$184.95**



4.5" DARK SMOKE



7" DARK SMOKE



10" LIGHT SMOKE



A. WIND SPLITTER WINDSHIELD – BATWING FAIRING
(4.5" DARK SMOKE SHOWN)



A. WIND SPLITTER WINDSHIELD – BATWING FAIRING
(7" DARK SMOKE SHOWN)



A. WIND SPLITTER WINDSHIELD – BATWING FAIRING
(10" LIGHT SMOKE SHOWN)



B. BATWING FAIRING WINDSHIELD – 15"



B. BATWING FAIRING WINDSHIELD – 12"



B. BATWING FAIRING WINDSHIELD – 10"

TOURING & TRIKE 223

Windshields — Electra Glide®

B. BATWING FAIRING WINDSHIELDS

Tailor your bike to your size and riding style. For the best compromise between adequate protection from the elements and a clear view of the road ahead, select a windshield that tops out just below eye level. This reduces helmet buffeting while allowing a view unobstructed by dirt, bugs and rain drops. Harley-Davidson® windshields are formed of hard-coated polycarbonate for strength and scratch resistance and are available in a variety of heights and tints to suit your riding needs.

Fits '14-later Electra Glide®, Street Glide®, Ultra Limited and Tri Glide® models.

57400224 15" Clear. **\$148.95**

57400228 12" Clear. **\$147.95**

57400226 12" Light Smoke. **\$147.95**

57400227 10" Clear. **\$147.95**

57400225 10" Light Smoke. **\$147.95**

Fits '96-'13 Electra Glide, Street Glide and Trike models.

58314-97 15" Clear. **\$152.95**

58187-96 12" Clear. **\$152.95**

58302-96 12" Light Smoke. **\$152.95**

58301-96 10" Clear. **\$152.95**

58303-96 10" Light Smoke. **\$152.95**

224 TOURING & TRIKE

Windshields — Electra Glide®

A. BATWING FAIRING WIND DEFLECTOR – MEDIUM PROFILE

Style meets function. This 7.0" tall Wind Deflector splits the difference between the wind deflector and a low windshield, offering sport styling with a little greater wind protection. Harley-Davidson® windshields are formed of hard-coated polycarbonate for strength and scratch resistance and the dark smoke tint complements any paint color.

57400229 7" Dark Smoke. **\$147.95**
Fits '14-later Electra Glide®, Street Glide®, Ultra Limited and Tri Glide® models.

57185-05 7" Dark Smoke. **\$142.95**
Fits '96-'13 Electra Glide, Street Glide and Trike models.
Stock on the '05 FLHTCSE models.



A. BATWING FAIRING WIND DEFLECTOR – MEDIUM PROFILE

B. BATWING FAIRING WIND DEFLECTOR – LOW PROFILE

Maintain your forward view with this low-profile wind deflector. The shield adds a radical shape to the traditional Batwing fairing and the dark smoke tint complements any paint color. Harley-Davidson windshields are formed of hard-coated polycarbonate for strength and scratch resistance.

57400243 5" Dark Smoke. **\$147.95**
Fits '14-later Electra Glide, Street Glide, Ultra Limited and Tri Glide models. Stock on '14 FLHX models.

58207-04 4" Dark Smoke. **\$142.95**
Fits '96-'13 Electra Glide, Street Glide and Trike models.
Stock on '04 FLHTCSE models.



B. BATWING FAIRING WIND DEFLECTOR – LOW PROFILE

C. 7" WIND SPLITTER ST WINDSHIELD – BATWING FAIRING

Combine functional performance and custom style with this gold-tone Wind Splitter Windshield. This Wind Splitter windshield is a great look for all Street Glide® models and is shaped for the perfect combination of effective airflow management and wow styling. Sweeping design complements the shape of the fairing and the inner dash panel, and adds height over a traditional low-profile wind deflector in the center where it counts. Shape decreases wind noise and improves your ability to hear the motorcycles sound system. Easy-to-install and features a center-mount Bar & Shield logo for a distinctive finishing touch.

57400528 **\$242.95**
Fits '14-later Electra Glide®, Street Glide®, Ultra Limited™ and Tri Glide® models.



C. 7" WIND SPLITTER ST WINDSHIELD - BATWING FAIRING



D. ADJUSTABLE AIR DEFLECTORS



E. ADJUSTABLE AIR DEFLECTOR KIT



F. FAIRING AIR DEFLECTORS



TOURING & TRIKE 225

Windshields — Electra Glide®

D. ADJUSTABLE AIR DEFLECTORS

The Adjustable Air Deflectors feature an infinitely adjustable friction pivot that holds the wing in position to direct the air where you need it. Close the vent to direct airflow around the fairing or open the vent to maximize airflow on hot days. Available in dark or light smoke finish, the translucent deflectors are easy to install with the included mounting hardware.

57000529 Dark Smoke. **\$131.95**
Fits '14-later Street Glide® models. Original Equipment on Electra Glide®, Ultra Limited and Tri Glide® models.

58156-08A Dark Smoke. **\$131.95**
Fits '08-'13 Electra Glide, Street Glide and Trike models.

E. ADJUSTABLE AIR DEFLECTOR KIT

Help keep your cool on hot summer rides. The smoked Adjustable Air Deflectors feature a spring-loaded detent system that locks in four different positions. Close the vent to direct airflow around the fairing or open the vent to maximize airflow on hot days. Easy to install, the complete kit includes left and right deflector and all necessary mounting hardware.

57804-07 Light Smoke. **\$131.95**
Fits '96-'13 Electra Glide, Street Glide and Trike models.

F. FAIRING AIR DEFLECTORS

Designed to deflect air away from the rider's elbows and upper torso, these easy-to-install Air Deflectors reduce the draft behind the fairing. Fixed-position deflectors are available in your choice of black or smoked finish to match your styling direction.

Fits '96-'13 Electra Glide, Street Glide and Trike models.

57740-05 Dark Smoke. **\$55.95**

58120-96A Light Smoke. **\$55.95**

226 TOURING & TRIKE

Fairing Trim

A. BLACK WINDSHIELD TRIM – GROOVED

Custom billet-look windshield trim accents the outer fairing and dresses your bike in style. The grooved design grabs your eye and adds character to the base of the windshield. Easy to install, the kit includes matching mounting hardware.

61400593 **\$163.95**

Fits '14-later Electra Glide®, Street Glide®, Ultra Limited and Tri Glide® models.

B. CHROME WINDSHIELD TRIM – GROOVED

Custom polished and chrome-plated billet windshield trim accents the outer fairing and dresses your bike in style. The grooved design grabs your eye and adds character to the base of the windshield. Easy to install, the kit includes stainless steel mounting hardware.

61400224 **\$167.95**

Fits '14-later Electra Glide, Street Glide, Ultra Limited and Tri Glide models.

C. EDGE CUT WINDSHIELD TRIM

Live your life on the edge. Custom windshield trim features a crisp anodized finish that is machined to expose the highlights of raw aluminum. The contrasting cut back look makes a powerful visual statement and works great with both traditional and contemporary customizing styles. Easy to install, the kit includes stainless steel mounting hardware.

61300358 **\$183.95**

Fits '14-later Electra Glide, Street Glide, Ultra Limited and Tri Glide models.

D. BAR & SHIELD WINDSHIELD TRIM

This highly polished stainless steel windshield trim is accented by four slots that allow the color of the outer fairing to show through. This unique trim piece is highlighted with Bar & Shield logo machined into the surface. Kit includes stainless steel mounting hardware.

61300275 **\$116.95**

Fits '14-later Electra Glide, Street Glide, Ultra Limited and Tri Glide models.

59133-99 **\$99.95**

Fits '96-'13 Electra Glide, Street Glide and Trike models.



A. BLACK WINDSHIELD TRIM – GROOVED



B. CHROME WINDSHIELD TRIM – GROOVED



C. EDGE CUT WINDSHIELD TRIM



D. BAR & SHIELD WINDSHIELD TRIM



E. WINDSHIELD TRIM – GLOSS BLACK



F. WINDSHIELD TRIM – CHROME



G. ILLUMINATED WINDSHIELD TRIM – CHROME



G. ILLUMINATED WINDSHIELD TRIM – GLOSS BLACK

TOURING & TRIKE 227

Fairing Trim

E. WINDSHIELD TRIM – GLOSS BLACK

Complete the blacked-out look. This easy to install windshield molding accents the outer fairing on batwing fairing equipped models, and simplifies the transition between the fairing and the base of the windshield. Kit includes one-piece trim and required mounting hardware.

61400325 **\$58.95**

Fits '14-later Electra Glide®, Street Glide®, Ultra Limited and Tri Glide® models.

F. WINDSHIELD TRIM – CHROME

Chrome Windshield Molding accents the outer fairing on Electra Glide models. Easily installed, including all necessary hardware and instructions.

61300310 **\$58.95**

Fits '14-later Electra Glide, Street Glide, Ultra Limited and Tri Glide models.

G. ILLUMINATED WINDSHIELD TRIM

Smoked lenses hide bands of amber LED lamps that glow as running lamps when the ignition is on, and the two outer clusters function as auxiliary directional indicators when the turn signals are activated. The wiring is concealed inside the fairing for a clean, custom appearance. Complete kit includes all necessary mounting hardware.

Fits '14-later Electra Glide, Street Glide, Ultra Limited and Tri Glide models. Installation on CVO™ models requires removal of current windshield trim. Not for use with Three-Pocket Fairing Pouch P/N 93300054B.

57000394A Chrome. **\$221.95**

57000395A Gloss Black. **\$221.95**

228 TOURING & TRIKE

Windshields — Road Glide®

A. WIND SPLITTER WINDSHIELD – ROAD GLIDE® MODEL

In the world of functional performance, size does matter. After all, it's simple to understand that the larger the windshield area, the greater the amount of wind deflection. The Wind Splitter Windshield is a great look for all Touring models and is shaped for the perfect combination of effective airflow management and "wow" styling. The sweeping design complements the shape of the fairing and the inner dash panel and adds height over a traditional low-profile wind deflector in the center where it counts. The shape decreases wind noise and improves your ability to hear the motorcycle's sound system. The rich smoked finish does not interfere with your forward view and looks great against any paint color. The easy-to-install Wind Splitter features a center-mount Bar & Shield medallion for a distinctive finishing touch.

Fits '15-later Road Glide® and '23-later FLTRT models.

57400271	12" Light Smoke.	\$210.95
57400270	15" Light Smoke.	\$229.95

Fits '98-'13 Road Glide models.

57400093	9" Dark Smoke.	\$173.95
57166-10A	12" Dark Smoke.	\$184.95

B. ROAD GLIDE® WINDSHIELDS

Tailor your bike to your size and riding style. For the best compromise between adequate protection from the elements and a clear view of the road ahead, select a windshield that tops out just below eye level. This reduces helmet buffeting while allowing a view unobstructed by dirt, bugs and rain drops. Harley-Davidson® windshields are formed of hard-coated polycarbonate for strength and scratch resistance and are available in a variety of heights to suit your riding needs.

Fits '15-later Road Glide® and '23-later FLTRT models.

57400279	19" Clear.	\$184.95
57400281	15.5" Clear.	\$173.95



A. 12" WIND SPLITTER WINDSHIELD – (57400271 SHOWN)



A. 15" WIND SPLITTER WINDSHIELD – (57400270 SHOWN)



A. 9" WIND SPLITTER WINDSHIELD – (57400093 SHOWN)



A. 12" WIND SPLITTER WINDSHIELD – (57166-10A SHOWN)



B. ROAD GLIDE 19" WINDSHIELD



B. ROAD GLIDE 15.5" WINDSHIELD



C. ROAD GLIDE ST 6" WIND DEFLECTOR



D. ROAD GLIDE 4" LOW-PROFILE WINDSCREEN



E. ROAD GLIDE 6" CONTOURED WIND DEFLECTOR – BLACK

TOURING & TRIKE 229

Windshields — Road Glide®

C. ROAD GLIDE® ST 6" WIND DEFLECTOR

Roll with custom style. This 6-inch Wind Deflector accentuates the curvaceous shape of the Road Glide® model's fairing, and hugs the contours of the splitstream vent.

57400526	Black.	\$242.95
Fits '15-later Road Glide® and '23-later FLTRT models.		

D. ROAD GLIDE 4" LOW-PROFILE WINDSCREEN

Sometimes, it's all about style. This minimalistic Low-Profile Windscreen accentuates the curvaceous shape of the Road Glide model's fairing, and hugs the contours of the splitstream vent. The opaque black finish defines the transition from the inner to the outer fairing surfaces, and provides a low, lean look to your custom ride.

57400310	Black.	\$168.95
Fits '15-later Road Glide and '23-later FLTRT models. Does not fit with Road Glide Fairing Pouch P/N 93300097.		

E. ROAD GLIDE 6" CONTOURED WIND DEFLECTOR – BLACK

Go low with this Road Glide model windshield that is contoured for a unique style.

57400280	Black.	\$152.95
Fits '15-later Road Glide and '23-later FLTRT models.		

Notice: The prices appearing in this catalog are the manufacturer's suggested retail prices. Actual retail prices may vary.

Notice: The prices appearing in this catalog are the manufacturer's suggested retail prices. Actual retail prices may vary.

230 TOURING & TRIKE

Fairing Trim

A. ROAD GLIDE® WINDSHIELD TRIM

The Road Glide® model's shark-like fairing is a bold and captivating styling element, so it requires just the right visual touch to complement the signature look. These elegant Windshield Trim components conceal the base of the windshield and sweep over the center Splitstream vent for a continuous band of "custom". Machined from billet aluminum, these easy-to-install components are available in a variety of finishes to match your customizing direction. Mix and match the black or chrome center and side trim to develop your own unique look. Side Trim Kits include left and right side trim and mounting hardware.

Fits '15-later Road Glide and '23-later FLTRT models. Installation requires one Side Trim Kit and one Center Trim Kit.

57400256	Side Trim – Black Billet.	\$127.95
57400294	Center Trim – Black Billet.	\$104.95

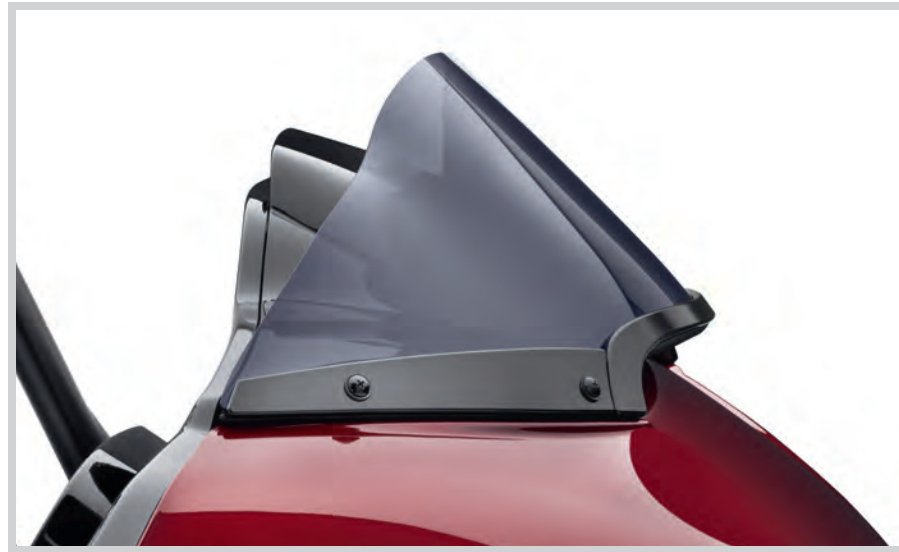

A. ROAD GLIDE WINDSHIELD TRIM – BLACK BILLET

B. ROAD GLIDE SPLIT WINDSHIELD TRIM

This easy-to-install, 2-piece trim kit adds a speed-stripe accent to the base of the windshield. Tapered from the leading to the trailing edge, the glass-smooth trim features counter bored mounting holes and flush-mount hardware for a clean, elegant look. Kit includes left and right trim and installation hardware.

Fits '15-later Road Glide and '23-later FLTRT models.

57400299	Chrome.	\$137.95
57400320	Satin Black.	\$137.95



B. ROAD GLIDE SPLIT WINDSHIELD TRIM – CHROME



B. ROAD GLIDE SPLIT WINDSHIELD TRIM – SATIN BLACK



C. ROAD GLIDE WINDSHIELD TRIM – CHROME (SHOWN WITH CONTOURED WIND DEFLECTOR)



C. ROAD GLIDE WINDSHIELD TRIM – GLOSS BLACK (SHOWN WITH WIND SPLITTER WINDSHIELD)



D. ROAD GLIDE COMPARTMENT LINERS

TOURING & TRIKE 231

Fairing Trim

C. ROAD GLIDE® WINDSHIELD TRIM

The fairing is a key visual element of your bike, so it demands the bold design of this elegant contoured windshield trim. This sweeping trim hugs the curvature of the fairing and conceals the base of the windshield and the windshield gasket for a clean, finished look. The multi-piece design simplifies installation. Kit includes mounting hardware and Road Glide® medallion.

Fits '04-'13 Road Glide models.

58519-07A	Chrome.	\$168.95
57400150	Gloss Black.	\$168.95

D. ROAD GLIDE COMPARTMENT LINERS

Protect your belongings and reduce noise and rattles on the road. Soft-touch felt finish liner is formed to the fairing glove box interior for a perfect fit. Molded base and sides maximize the interior room and one-piece design allows easy removal for cleaning and maintenance.

76000539 \$45.95

Fits '15-later Road Glide models. Right liner includes integrated mobile device storage net.

232 TOURING & TRIKE

Fairing – Accessories

A. THREE-POCKET BATWING FAIRING POUCH – '14-LATER MODELS

Convenient storage space at your fingertips. Designed to complement H-D® Wind Deflectors and Windshields, this fairing pouch is ideal for storing mobile devices, sunglasses and other small items. The sturdy plastic pouches are wrapped in supple UV-resistant vinyl for a premium look and feel and the magnetic closures keep your items within reach without detracting from the tastefully smooth styling.

93300054B **\$143.95**
Fits '14-later Electra Glide®, Street Glide®, Ultra Limited and Tri Glide® models with windshields. Not for use with Wind Splitter Windshields P/N 57400204 or 57400205. Not for use with Illuminated Windshield Trim P/N 57000394 or 57000395.



A. THREE-POCKET BATWING FAIRING POUCH – '14-LATER MODELS

B. THREE-POCKET BATWING FAIRING POUCH – '96-'13 MODELS

Convenient storage space at your fingertips. Designed to complement H-D Wind Deflectors and Windshields, this fairing pouch is ideal for storing cell phones, sunglasses and other small items. The sturdy plastic pouches are wrapped in supple UV-resistant vinyl for a premium look and feel and the magnetic closures keep your items within reach, while not detracting from the tastefully smooth styling. The left-hand pouch can be easily removed to accommodate your fairing-mounted GPS unit. Attractive Harley-Davidson script is featured on the front center pouch and on the outboard-facing side, visible through the windshield.

58900-11 **\$127.95**
Fits '96-'13 Electra Glide, Street Glide and Trike models. Not for use with Fairing Dash Pads. Models equipped with Illuminated Windshield Molding P/N 57335-08 requires separate purchase of Screws P/N 4456 (Qty 3), Bar & Shield Windshield Molding P/N 59133-99 requires separate purchase of Screws P/N 94386-92T (Qty 3), Chrome Windshield Trim P/N 59213-96 requires separate purchase of Screws P/N 94397-91T (Qty 3).



B. THREE-POCKET BATWING FAIRING POUCH – '96-'13 MODELS

C. THREE-POCKET WINDSHIELD POUCH

Add convenient storage space up front where you need it. This easy-to-install windshield pouch features three easily accessible storage pockets sized for cell phones, glasses and other small items. The center pouch is accented with an embossed Harley-Davidson script for a finishing touch.

58904-03 **\$136.95**
Fits King-Size (except Springer™ and Rigid-Mount King Size) and Road King® windshields (except Wind Deflector and Adjustable Height).



B. THREE-POCKET BATWING FAIRING POUCH – '96-'13 MODELS (SHOWN WITH GPS UNIT)



C. THREE-POCKET WINDSHIELD POUCH



D. ROAD GLIDE FAIRING POUCH



D. ROAD GLIDE FAIRING POUCH – OPEN



E. TWO-POCKET WINDSHIELD POUCH



F. EMBOSSED BAR & SHIELD LOGO LEATHER WINDSHIELD BAG



G. ROAD KING CLASSIC LEATHER WINDSHIELD BAG

TOURING & TRIKE 233

Fairing – Accessories

D. ROAD GLIDE® FAIRING POUCH

This two-pocket Fairing Pouch is ideal for storing mobile devices, sunglasses and other small items. Contoured for a custom fit, the dash pad and pouch system fits perfectly with Harley-Davidson® wind deflectors and windshields. The sturdy molded pouches are wrapped in supple UV-resistant vinyl for a premium look and feel, and the magnetic closures keep your items within reach. The left pouch provides easy access to the Road Glide model's Splitstream vent control button.

93300097 **\$170.95**
Fits '15-later Road Glide® and '23-later FLTRT models. Does not fit with Road Glide® Low-Profile Windscreen P/N 57400310. CVO™ Road Glide® requires installation of windshield.

E. TWO-POCKET WINDSHIELD POUCH

Add convenient storage space up front where you need it. This easy-to-install windshield pouch features two easily accessible storage pockets sized for cell phones, glasses and other small items. Hook-and-loop closures allow easy one-handed opening. Both pouches are accented with an embossed Harley-Davidson logo for a finishing touch.

57203-07 **\$122.95**
Fits King-Size or Compact windshields. Does not fit FXDWG, FLSTSB or FXSTD models. Does not fit Rigid-Mount, Super Sport, Nostalgic or Flamed windshields.

F. EMBOSSED BAR & SHIELD LOGO LEATHER WINDSHIELD BAG

Black domestic steerhide bag features an embossed Bar & Shield logo.

58308-95 **\$110.95**
Fits King-Size and Compact windshields (except FXSTD, Flame and Skull with Wings). Does not fit 100th Anniversary logo windshields, models equipped with handlebar mount gauges or Road Tech™ Riser Mount Radio.

G. ROAD KING® CLASSIC LEATHER WINDSHIELD BAG

Leather bag features textured leather insert, H-D® concho and a turnbuckle closure.

58189-98 **\$127.95**
Fits King-Size and Compact windshields (except FXSTD, Flame and Skull with Wings). Does not fit 100th Anniversary logo windshields, models equipped with handlebar mount gauges or Road Tech Riser Mount Radio.

234 TOURING & TRIKE

Fairing Lower

A. FAIRING LOWER FITTED GLOVE BOX LINER KIT

Protect your belongings and reduce noise and rattles on the road. Soft-touch felt finish liner is formed to the fairing glove box interior for a perfect fit. Molded base and sides maximize the interior room and one-piece design allows easy removal for cleaning and maintenance.

57100270 **\$45.95**

Fits '14-later Touring and Trike models equipped with Original Equipment or accessory Vented Fairing Lower. Does not fit models equipped with Twin-Cooled™ engines.



A. FAIRING LOWER FITTED GLOVE BOX LINER KIT

B. FLT AND FLHT FAIRING LOWER GLOVE BOXES

Offers a convenient place to store riding gloves, sunglasses, etc. The snap-on door cover (included) is embossed with Bar & Shield logo. Available in black only.

58684-89B Right Side. **\$191.95**

Fits '04-earlier Original Equipment non-vented style FLHT Ultra Classic® Fairing Lower.



B. FLT AND FLHT FAIRING LOWER GLOVE BOXES

C. FAIRING LOWER QUICK-RELEASE HARDWARE KIT

Beat the summer heat and prepare for around-town cruising by removing the fairing lowers on your Ultra Classic® Electra Glide® model. This kit includes highly polished stainless steel clamps that are detachable without the need for tools.

47200240 **\$139.95**

Fits '14-later FLHTCU and FLHTCUL models. Also fits '14-later Touring models equipped with Accessory Fairing Lower. Does not fit models equipped with Twin-Cooled™ engines. Does not fit models equipped with Fairing lower speakers.

58146-07 **\$121.95**

Fits '05-'13 Touring and Trike models equipped with Vented Fairing Lower and '88-later Touring and Trike models equipped with Vented Fairing Lower Kit 58854-YYXXX. Does not fit models equipped with fairing lower speakers.

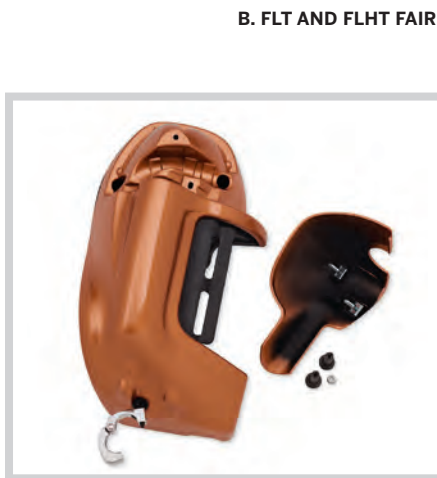

C. FAIRING LOWER QUICK-RELEASE HARDWARE KIT – '14-LATER MODELS

D. SOFT LOWERS

Extend your riding season. Full-coverage Soft Lower provide wind and mud protection for the rider's legs and boots and minimize cold updrafts as the weather changes. Covers are custom shaped to hug the engine guard to minimize flapping and they simply clip in place for speedy installation as the weather changes. Two-way zippered outer edge accommodates guard-mounted highway pegs in almost any position. Reflective piping provides added visibility and convenient zippered pockets provide additional storage for maps or other small items.

57100210 **\$102.95**

Fits '80-later Touring and Trike models equipped with engine guards. Does not fit with Original Equipment or accessory Color-Matched Fairing Lower. Does not fit Mustache or Chopped Engine Guards. Does not fit models with Extended Reach Brake Lever or Extended Reach Shift Lever. FLHXXX models require separate purchase of engine guards.



D. SOFT LOWERS – FRONT VIEW



E. MID-FRAME AIR DEFLECTOR – SMOKED



F. MID-FRAME AIR DEFLECTOR – (57200157 SHOWN)



G. FAIRING LOWER QUICK-RELEASE HARDWARE KIT – '14-LATER MODELS



G. MID-FRAME AIR DEFLECTOR TRIM – (58002-09A SHOWN)



H. ROAD GLIDE WIND DEFLECTOR KIT



H. WIND DEFLECTOR – (57000510 SHOWN)



H. WIND DEFLECTOR – (5700063 SHOWN)

TOURING & TRIKE 235

Air Deflectors

E. MID-FRAME AIR DEFLECTOR – SMOKED

Our new smoked Lexan Mid-Frame Air Deflector improves style and comfort. Fits perfectly between your Harley-Davidson® Touring or Trike frame and side panels to direct engine heat away from the rider and improve comfort on hot summer rides. Designed and tested for severe duty and extreme temperature applications. Durable smoked Lexan material adds subtle style. Easy to install and includes required mounting hardware

57200356 **\$108.95**

Fits '09-later Touring and Trike models. Not compatible with '17-later models equipped with Cool Flow™ Fan P/N 26800120, 26800121 and 26800128. Stock on '20-later CVO™ models.

F. MID-FRAME AIR DEFLECTOR

Designed for severe duty and extreme temperature applications. These black deflectors attach to the frame below the seat and direct heat away from the rider to improve comfort. Kit includes all necessary hardware.

58002-09A **\$97.95**

Fits '09-later Touring and Trike models. Not compatible with '17-later models equipped with CoolFlow™ Fan P/N 26800120, 26800121 and 26800128.

57200157 **\$97.95**

Fits '17-later Touring and Trike models equipped with CoolFlow Fan P/N 26800120, 26800121 and 26800128.

58022-07A **\$97.95**

Fits '01-'08 Touring models. Does not fit '01-'07 models equipped with Adjustable Rider Backrests.

G. MID-FRAME AIR DEFLECTOR TRIM

This injection-molded trim adds a touch of chrome to the Mid-Frame Air Deflectors on touring vehicles. These chrome accents blend the look of chrome from the engine and help make the deflectors look integrated with the bike.

61400028 **\$64.95**

Fits '09-later Touring and Trike models with Original Equipment Mid-Frame Air Deflectors. Also fits models equipped with Mid-Frame Air Deflectors P/N 58002-09. Does not fit '17-later models equipped with CoolFlow Fan Kits.

H. ROAD GLIDE® WIND DEFLECTOR KIT

Easy to install, these snap-fit Wind Deflectors reduce and redirect the airflow that rises between the fairing and fork tubes. The resulting reduction in updraft can dramatically reduce buffeting for many riders.

57000510 **\$49.95**

Fits '15-later Road Glide® models (except '18-later FLTRXSE models, '21-later FLTRXS and '22-later FLTRXST models). Stock on '15-later FLTRUSE and '20 FLTRK. Does not fit with Chopped Engine Guards P/N's 49000105A or 49000114A.

5700063 **\$49.95**

Fits '98-'13 Road Glide models. (Will not fit models equipped with the Fuel Tank retrofit mounting kit.) Stock on '11-'13 CVO™ Road Glide models.

236 TOURING & TRIKE

Rider Comfort

A. COOLFLOW™ FAN

Unlike traditional fan kits that try to cool the engine by blowing air across the cylinders and often onto your legs, the CoolFlow™ Fan Kit keeps the riders comfortable by pulling air away from the rear cylinder and exhaust pipe, and directing it toward the ground.

The CoolFlow Fan features switched On/Off/Auto operation on '17-later models and On/Off on '09-'16 models. In the "ON" mode, the fan is active at low speeds, and will turn off when the bike reaches 40mph. As speed drops, the fan turns back on at 35 mph. This logic program prevents the fan from cycling on and off during low speed changes. On '17-later models, the AUTO setting operates based on a combination of speed parameters and specific engine and ambient temperatures. Built to withstand the harsh motorcycle environment, the all-weather CoolFlow Fan is 100% waterproof and includes everything you need for installation. The plug-and-play design is integrated with the vehicle electronics, so "On/Off/Auto" fan operation is indicated in the odometer screen. Your dealer will enable this function in the Electronic Control Module (ECM) and you're ready to roll. Odometer fan status display feature availability varies by model and may not be available for your vehicle.

26800121 \$319.95

Fits '17-later FLHR, FLHRC, FLHRXS, FLHP and FLRT models. Does not fit with Starter End Cover P/N 31400088 and 31400090. FLHRC Brazil configurations and FLHP (all regions) require separate purchase of Mid-Frame Air Deflector P/N 57200151. Separate purchase of Mid-Frame Air Deflector Kit P/N 57200157 is recommended for maximum performance on all other vehicles. Dealer Digital Technician™ update is required to display fan status.

26800120 \$319.95

Fits '17-later FLHT, FLHXS, FLHXST, FLHXSE, FLTRX, FLTRXS and FLTRXST models. Does not fit with Starter End Cover P/N 31400088 and 31400090. FLHXS and FLHXSE Brazil configurations require separate purchase of Mid-Frame Air Deflector P/N 57200151. Separate purchase of Mid-Frame Air Deflector Kit P/N 57200157 is recommended for maximum performance on all other vehicles. Dealer Digital Technician™ update is required to display fan status.

26800128 \$319.95

Fits '17-later FLHTCU, FLHTCUTG, FLHTCUTGSE, FLHTK, FLHTKL, FLHTKSE, FLHTP, FLTRK and '17-'19 FLTRU models. Does not fit with Starter End Cover P/N's 31400088 and 31400090. FLHTCUTG (HDI, ENG, HDJ configurations only), FLHTP models require separate purchase of Switch Pack P/N 69200173 and Switch Buttons (2) P/N 71400031. Includes replacement right side Mid-Frame Air Deflector. Dealer Digital Technician update is required.

26800152 \$319.95

Fits '09-'16 Touring and Trike models with or without Original Equipment Mid-Frame Air Deflectors. Separate purchase of Mid-Frame Air Deflector Kit P/N 58002-09A is recommended for maximum performance if not equipped. '15-'16 FLRT models require separate purchase of Switch Pack P/N 71522-08.

B. FAN ASSISTED OIL COOLER

Keep your cool. This easy-to-install Oil Cooler features a thermostatically controlled fan that provides continuous flow of cooling air – even while the bike is idling in traffic or moving at low speed. Ideal for bikes that see parade duty and other low speed or continuous idle situations, the Fan Assisted Oil Cooler is also the perfect addition to a bike modified with high-performance components. The fan automatically engages when the engine oil temperature rises, and when in operation, the Fan Assisted Oil Cooler can provide up to a 50-degree drop in oil temperature. And unlike other models, the Harley-Davidson® Fan Assisted Oil Cooler utilizes weather-rated fans and electronics that are designed for the harsh motorcycle environment. Engineered as a bolt-on replacement for the Original Equipment oil cooler, the Fan Assisted Oil Cooler is plug-and-play compatible with your bike's wiring harness. No splicing or rewiring is required. ECM reprogramming by a Harley-Davidson Dealer is required to complete the installation.

62700204 \$362.95

Fits '17-later Touring models equipped with air/oil-cooled Milwaukee-Eight® engines. Does not fit models equipped with Twin-Cooled™ engines. Not compatible with Oil Cooler Cover P/N 25700633 or 25700634. Original Equipment on oil-cooled Police and Freewheeler® models.



A. COOLFLOW FAN



A. COOLFLOW FAN (26800120 SHOWN)



A. COOLFLOW FAN (26800128 SHOWN)



B. FAN ASSISTED OIL COOLER

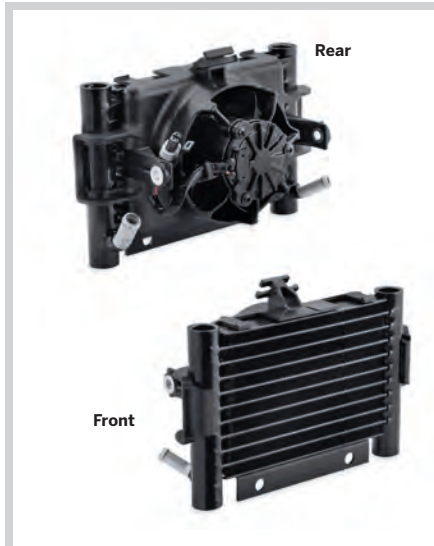

Front

Rear



C. MILWAUKEE-EIGHT® ENGINE OIL COOLER FAN



D. PREMIUM OIL COOLER KIT – '09-'10 TOURING (26155-09A SHOWN)



D. PREMIUM OIL COOLER KIT – '09-'10 TOURING (26155-09A SHOWN)



D. PREMIUM OIL COOLER KIT (26082-05C SHOWN)

TOURING & TRIKE 237

Oil Coolers

C. MILWAUKEE-EIGHT® ENGINE OIL COOLER FAN

Traffic jam? This Oil Cooler Fan can help keep Milwaukee-Eight Engine oil temperature under control if you find yourself idling or moving slowly in traffic, especially in hot weather. Fan automatically engages to lower oil temperature up to 50 degrees compared to an oil cooler without a fan. Weather-proof for durability. Perfect addition to a bike equipped with high performance components. Ideal for bikes that see parade duty and other low speed or continuous idle situations. Fan automatically engages when the engine oil temperature rises. When in operation the Oil Cooler Fan can provide up to a 50 degree drop in oil temperature compared to an oil cooler without a fan. The Harley-Davidson® Oil Cooler Fan utilizes weather-rated fans and electronics that are designed for reliable service in the harsh motorcycle environment. Engineered for bolt-on installation and plug-and-play compatibility with your bike's wiring harness without unhooking messy oil lines. ECM reprogramming by a Harley-Davidson® Dealer is required to complete the installation. No splicing or rewiring is required.

26800195 \$270.95

Fits '17-later Touring models equipped with air/oil-cooled Milwaukee-Eight® engines. Does not fit models equipped with Twin-Cooled™ engines, or Trike and Police models equipped with fan assisted oil coolers. Not compatible with Oil Cooler Cover P/N 25700633 or 25700634.

D. PREMIUM OIL COOLER KITS – TOURING

This oil cooler was designed specifically for Harley-Davidson to out-perform all other coolers in the industry. The cooler features a unique "Turbulator" system that evenly distributes oil across the cooling chambers. The air fins are designed to efficiently dissipate heat. The oil cooler has been designed to simplify installation and enhance performance. The large heat exchanger provides excellent cooling efficiency. The kit features a one-piece adapter plate with integrated thermostat that allows oil lines to connect to the oil filter bracket. Thermostat activates at 185°F (85°C). Kit comes complete with mounting hardware and precut oil lines.

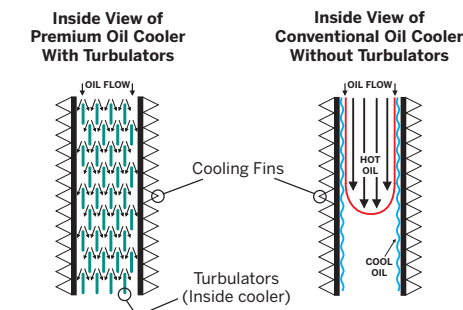

Turbulators disperse and mix oil inside cooler to provide more efficient cooling capabilities. The cooler oil is not allowed to remain along the boundaries of the flow tube as in conventional coolers.

Coolers without the Turbulator system allow oil to flow only in a straight path. Oil does not mix and the cooler oil remains along the outer boundaries, while the hotter oil remains along the center path of flow. Without the mixing effects of the Turbulators, the conventional oil cooler provides less efficient cooling capabilities.

26155-09A Horizontal Mount. \$460.95

Fits '09-'10 Touring models. Does not fit with Voltage Regulator Cover P/N 74538-09, DEFINITIVE5™ Filtration System Kit or models equipped with a sidescar.

26082-05C Horizontal Mount. \$460.95

Fits '99-'06 Touring models. Does not fit with Chrome Display Stand P/N 99002-97A, Voltage Regulator Cover P/N 74538-09, DEFINITIVE5 Filtration System Kit or models equipped with a sidescar.

Notice: The prices appearing in this catalog are the manufacturer's suggested retail prices. Actual retail prices may vary.

Notice: The prices appearing in this catalog are the manufacturer's suggested retail prices. Actual retail prices may vary.

COMFORT IS KING

The ability to spend hours behind the handlebars and rack up hundreds of miles without stopping is dictated by how you feel on your bike. The shape of the seat, the reach to the handlebars and the location of your feet are all major factors in how far you can travel in a day. But don't forget your passenger's needs — he or she has a stake in this ride as well.

THE RIDER & PASSENGER ENVIRONMENT

Accessories that impact the rider and passenger's physical contact with the motorcycle and the management of wind, temperature and road conditions should be your first consideration in building the ultimate touring machine.



RIDER/PASSENGER CONTACT POINTS	PAGE #	RIDER/PASSENGER ENVIRONMENT	PAGE #
1 PASSENGER BACKREST	254-265	9 HEATED PASSENGER BACKREST	264-265
2 PASSENGER ARMRESTS	249	10 HEATED RIDER & PASSENGER SEATING	243-249
3 RIDER BACKREST	250-251	11 HEATED GRIPS	498-499
4 RIDER & PASSENGER SEATING	240-248	12 WINDSHIELDS	218-231
5 HANDLEBAR	540-550	13 WIND DEFLECTORS	234-235
6 HIGHWAY PEGS	500-503	14 FAIRING LOWERS	234
7 FOOTBOARDS & FOOT CONTROLS	280-287	15 COOLFLOW FAN	236
8 PASSENGER FOOTBOARDS	284-287	16 ADJUSTABLE SUSPENSION	290-293

ENJOY THE RIDE

The relationship between the seat, the handlebar and the foot controls has an enormous impact on the comfort, control and confidence you feel when riding your motorcycle. Once you've picked the bike, it's time to choose the options that match your ride to your personal dimensions.



For shorter riders, consider tailoring your fit by changing to a Reach® Seat, Standard Foot Controls and lowered suspension height.



For taller riders, consider altering your ride by changing to a Tallboy® Seat and Extended Foot Controls.

ESTABLISH YOUR POSITION AND FEEL

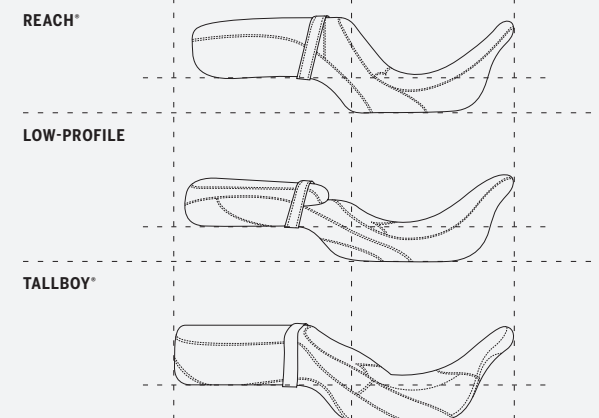

SEATS

Seat height and shape impact rider comfort, fit and confidence. Where the seat positions you relative to the foot controls, hand controls and the ground plays a major role in the quality of your ride.

SEE PAGES 240-248

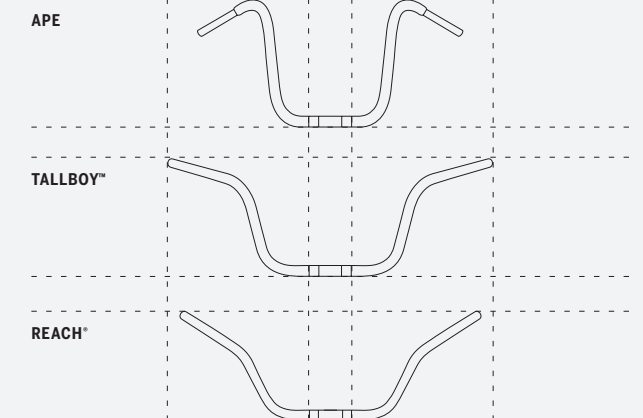

HANDLEBARS

Where the bar positions your arms, hands and wrists directly impacts how you feel on the motorcycle. Choose a bar that falls easily to hand, and does not pull you out of the seat when maneuvering.

SEE PAGES 530-540

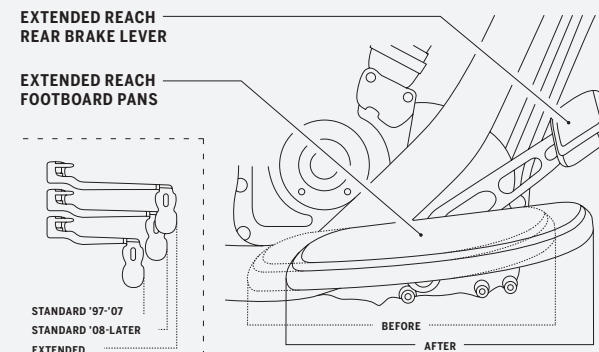

FOOT CONTROLS

Repositioning your feet can relieve muscle tension, take pressure off the tailbone and reduce fatigue. The correct riding position can add hours of comfort and hundreds of miles to your daily saddle time.

SEE PAGES 280-281

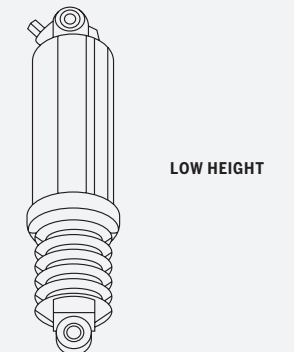

SUSPENSION

Adjusting your motorcycle's ride height by raising or lowering the suspension is often the first step in fitting the bike to your stature. Being sure-footed at a stop can really increase your sense of confidence.

SEE PAGES 290-293

240 TOURING & TRIKE

Seating – Reach®

REACH® SEATS

Designed to position riders with a shorter inseam closer to the ground, Reach® Seats are shaped to place the rider in a comfortable and confident relationship to the hand and foot controls. The wide seating surface provides loads of support while riding and the narrow tapered nose brings your legs together for an easier reach to the ground at a stop. Reach Seats feature a stepped profile that provides back support and keeps the rider from sliding back during acceleration.

A. SUPER REACH SEAT

Get a little bit closer. Super Reach forward position seats are designed to move riders with a shorter inseam even closer to the controls and to bring the legs about 1.0" closer together so that your feet rest firmly on the pavement. The scooped bucket-shape saddle is enhanced with added back support padding to move the rider lower and forward.* The combination positions the rider closer to the hand and foot controls to offer both comfort and confidence. Seat can be equipped with optional rider backrest for added support and comfort.

*Measurements based on Original Equipment Electra Glide® seat:

'09 models – 2.0" lower, 2.5" forward
'10-'13 models – 1.5" lower, 2.5" forward
'14-later models – .5" lower, 2.0" forward

54382-11 **\$419.95**
Fits '09-'13 Touring and Trike models. Also fits '14-later Touring models not equipped with Tour-Pak® luggage. Installation on '12-later CVO™ models requires removal of fender trim strips. Seat width 13.0"; passenger pillion width 12.0".



A. SUPER REACH SEAT



B. REACH SOLO SEAT

B. REACH SOLO SEAT

From the custom metal Bar & Shield medallion to the sleek fast-back design, this seat is shaped to deliver the ergonomic position that a shorter rider needs. Sculpted and molded to ease the reach to the ground, this Reach Solo seat places the rider 3/8" lower and 1-1/4" forward when compared to the stock FLHX seat*. The narrow nose and the low overall height provides the rider with added confidence and control while the bike is at a stop or during parking maneuvers, while the generous seating width adds support for the long haul. And the seat's upturned tail moves you closer to the controls without confining you to one position. For maximum comfort and support, this seat is recommended for smaller-framed riders between 5'-2" and 5'-8" tall.

*Measurement as compared to other seating options:

– Original Equipment 2016 Electra Glide® model seat – 1.25" lower, 0.8" forward
– Original Equipment 2016 Street Glide® model seat – 0.375" lower, 1.25" forward
– Original Equipment 2016 Electra Glide Low model seat – .500" lower, .500" rearward

52000253 **\$362.95**
Fits '09-later Touring models. Does not fit Trike models. Does not fit models equipped with Passenger Grab Rails. Does not accept rider backrest or passenger pillion. Seat width 15.0".

C. REACH TWO-UP SEAT – '14-LATER MODELS

Original Equipment on the Ultra Classic® Low and Ultra Limited Low models, this Reach seat brings the legs about 1.0" closer together and features enhanced back support padding that moves the rider .8" lower and 1.5" forward without locking the rider into a cramped position.* The Reach seat can be equipped with an optional rider backrest for additional touring comfort.

*Measurements based on Original Equipment Electra Glide seat.

52000334 **\$432.95**
Fits '14-later Touring and Trike models. Seat width 15.5"; passenger pillion width 16.0".



C. REACH TWO-UP SEAT – '14-LATER MODELS



D. REACH TWO-UP SEAT – '09-'13 MODELS

TOURING & TRIKE 241

Seating – Reach®

D. REACH® TWO-UP SEAT – '09-'13 MODELS

This Reach® forward position seat brings the legs about 1.0" closer together and features enhanced back support padding that moves the rider lower and forward.* Seat can be equipped with optional rider backrest for added support and comfort.

*Measurements based on Original Equipment Electra Glide® seat:

'09 models – 1.0" lower, 2.5" forward
'10-'13 models – .5" lower, 2.5" forward
'14-later models – stock height, 2.0" forward

54383-11 **\$419.95**
Fits '09-'13 Touring and Trike models. Also fits '14-later Touring models not equipped with Tour-Pak® luggage. Installation on '12-later CVO™ models requires removal of fender trim strips. Seat width 13.0"; passenger pillion width 12.0".

E. REACH TWO-UP SEAT – '97-'07 MODELS

This Reach forward position seat has a tapered nose to bring the legs closer together. The bucket-shaped pillow-look saddle features added back support padding that moves the rider approximately 1.5" lower and 1.5" forward. Seat can be equipped with an optional Rider Backrest Kit for added support.

52544-05A **\$419.95**
Fits '97-'07 Electra Glide (except FLHX) and '98-'07 Road Glide® models. Seat width 16.0"; passenger pillion width 13.0".

52609-05 **\$419.95**
Fits '97-'07 Road King® (except FLHRS) and FLHX models. Also fits '97-'07 FLHT and FLTR models equipped with Fuel Tank Console P/N 71288-03A or Trim Piece P/N 52447-96. Seat width 16.0"; passenger pillion width 13.0".



E. REACH TWO-UP SEAT – '97-'07 MODELS



Reach Seats

Notice: The prices appearing in this catalog are the manufacturer's suggested retail prices. Actual retail prices may vary.

Notice: The prices appearing in this catalog are the manufacturer's suggested retail prices. Actual retail prices may vary.

242 TOURING & TRIKE

Seating – Tallboy®

TALLBOY® SEATS

The correct riding position can help a tall rider sit comfortably on the bike and avoid leg cramps and back strain during a long day in the saddle. For riders with a longer inseam, a Tallboy® Seat will put you on the road to fatigue-free riding. Designed to move the rider up and back from the stock seating position, a Tallboy Seat can eliminate the knees-high riding position and effectively places the body for a natural arm and leg reach to the controls. Tallboy Seats feature a bucket-shaped design for added support and a wide seating surface to reduce pressure on the tailbone.

A. TALLBOY SEAT – '14-LATER MODELS

This Tallboy Seat moves the rider back 1.5"* to provide much-needed arm and leg room for the long-limbed rider. The seat is sculpted to provide superior support and comfort, with a slight bucket shape to provide room to vary your riding position fore and aft. The seat's level seating surface does not pitch the rider forward, and the overall ride height is similar to stock Electra Glide® and Road Glide® Ultra seating. Passenger comfort will be maximized with the Tour-Pak® Luggage mounted in the rear most position. Tallboy seats can be equipped with an optional rider backrest (except Adjustable Style) for additional touring comfort.

*Measurements based on Original Equipment Electra Glide seat.

52000252 \$419.95
Fits '14-later Touring and Trike models. Not compatible with Adjustable Rider Backrest kits. Seat width 16.5"; passenger pillion width 15.0".

B. TALLBOY SEAT – '08-'13 MODELS

This Tallboy Seat moves the rider back* to provide much-needed arm and leg room for the long-limbed rider. The seat height is similar to stock and the slight bucket shape offers additional lower back support. Passenger comfort will be maximized with the Tour-Pak Luggage mounted in the rear-most position. Accepts rider backrest (except Adjustable Style) for additional touring comfort.

*Measurements based on Original Equipment Electra Glide seat:

'08-'13 models – stock height, 2.0" rearward
'14-later models – stock height, 1.5" rearward

52099-09A \$419.95
Fits '08-'13 Touring and Trike models. Also fits '14-later Touring models not equipped with Tour-Pak. Does not fit models equipped with Adjustable Rider Backrest Kits or Passenger Grab Rails. Installation on '12-later CVO™ models requires removal of fender trim strips. Seat width 16.0"; passenger pillion width 14.0".

C. TALLBOY SEAT – '97-'07 MODELS

This Tallboy one-piece seat moves the rider back .5" and up 1.25" compared to the Original Equipment seat. The new position allows additional leg and arm movement for the long-limbed rider and a comfortable seating space for the open road. The bucket design of the Tallboy Seat provides additional rider back support and the wide raised pillion places the passenger for maximum comfort and commanding view. Can also be used with Rider Backrest Kits.

52975-05 \$419.95
Fits '97-'07 Electra Glide® (except FLHX) and Road Glide® models. Seat width 17.5"; passenger pillion width 15.0".

52976-05 \$419.95
Fits '97-'07 Road King® and FLHX models. Also fits '97-'07 Electra Glide and Road Glide models equipped with Fuel Tank Console P/N 71288-03A or Trim Piece P/N 52447-96. Seat width 17.0"; passenger pillion width 16.0".



A. TALLBOY SEAT – '14-LATER MODELS



B. TALLBOY SEAT – '08-'13 MODELS



C. TALLBOY SEAT – '97-'07 MODELS



Notice: The prices appearing in this catalog are the manufacturer's suggested retail prices. Actual retail prices may vary.

TOURING & TRIKE 243

Seating – Heated & Cooled

D. HARLEY® HAMMOCK HEATED & COOLED SEAT

Extend and optimize your riding season thanks to cooling and heating technology built into this premium seat for Touring and Trike models. The electronic heating/cooling system is self-contained within the seat. The seat can be easily removed after unplugging a single cord. This seat offers industry-leading cooling performance, and the heating function has been improved to reach its selected temperature twice as fast as previous heated seats. The Hammock seat is our most-premium touring seat design, created for the rider who wants the ultimate in long-haul comfort. For the rider it features a sling-like fabric suspension system that acts like a hammock, providing two inches of suspension above the seat pan, topped with an additional two inches of traditional foam cushioning. This internal suspension prevents "bottoming out" and provides an improvement in comfort and endurance by isolating the rider from harsh road conditions. The passenger position features a multiple spring-board style suspension system along with two inches of traditional foam. This seat really improves comfort and reduces fatigue on long rides. Greater comfort reduces fatigue and extends the riding season in any climate. In testing with a baseline ambient temperature of 85 degrees the seat cover will cool down by 25 degrees in about 30 minutes, from your 98-degree body temperature to about 76 degrees. As you ride, the cooling function draws heat away from your body, which makes you feel cooler. Dual Zone Control: Rider passenger seating positions must use the same temperature mode (heat or cool) but can adjust the level to individual preference or switch the function off. Redesigned heating element reaches selected temperature in only seven minutes. Seam-sealed construction prevents rain or wash water from infiltrating the seat foam. No riding for hours on a squishy seat. Compatible with Rider Backrest Mounting Kit (P/N 52589-09A)

52000462 \$372.95
Fits '14-later Touring and Tri Glide® models. '14-'16 models require separate purchase of Electrical Harness extension P/N 69200722. '17-later models require separate purchase of Electrical Harness P/N 69201599A. Installation on '14-later Tri Glide models require separate purchase of Trike Support Bracket P/N 52100063.



D. HAMMOCK HEATED & COOLED SEAT

E. SUNDOWNER™ HEATED & COOLED SEAT

Extend and optimize your riding season thanks to cooling and heating technology built into this premium seat for Touring and Trike models. Clever engineering has maintained the same footprint as the existing Sundowner seats, even with cooling & heating functionality. The seat can be easily removed after unplugging a single connection. This seat offers industry-leading cooling performance, and the heating function has been improved to reach its selected temperature twice as fast as previous heated seats. The two-up Sundowner™ Seat is engineered to provide the maximum in long-riding comfort. The deep-bucket design puts most riders in an ideal touring posture, and the generous padding makes it comfortable for both the rider and passenger as the miles are adding up. Greater comfort reduces fatigue and extends the riding season in any climate. In testing with a baseline ambient temperature of 85 degrees the seat cover will cool down by 25 degrees in about 30 minutes, from your 98-degree body temperature to about 76 degrees. As you ride, the cooling function draws heat away from your body, which makes you feel cooler. Dual Zone Control: Rider passenger seating positions must use the same temperature mode (heat or cool) but can adjust the level to individual preference or switch the function off. Redesigned heating element reaches selected temperature in only seven minutes. Seam-sealed construction prevents rain or wash water from infiltrating the seat foam. No riding for hours on a squishy seat. Compatible with Rider Backrest Mounting Kit (P/N 52589-09A)

52000463 \$956.95
Fits '14-later Touring and Tri Glide® models. '14-'16 models require separate purchase of Electrical Harness extension P/N 69200722. '17-later models require separate purchase of Electrical Harness P/N 69201599A. Installation on '14-later Tri Glide models require separate purchase of Trike Support Bracket P/N 52100063.

F. HEATED & COOLED SEAT SUPPORT BRACKET

Support bracket required for installing Harley Hammock Heated & Cooled Seat or Sundowner Heated & Cooled Seat on Tri Glide models.

52100063 \$32.95
Fits '14-later Tri Glide models. Required for installation of Harley® Hammock Heated & Cooled Seat P/N 52000462 or Sundowner Heated & Cooled Seat P/N 52000463.



E. SUNDOWNER HEATED & COOLED SEAT

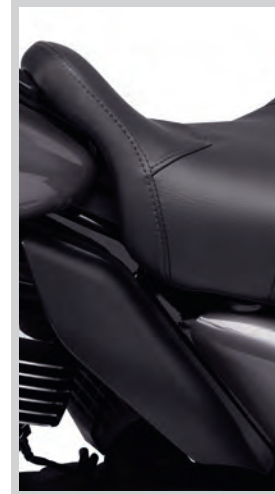

Notice: The prices appearing in this catalog are the manufacturer's suggested retail prices. Actual retail prices may vary.

244 TOURING & TRIKE

Seating – Harley® Hammock

ROAD ZEPPELIN® AIR ADJUSTABLE SEATS

The open road. That's where we developed and tested the revolutionary comfort of the Road Zeppelin® Seat. This remarkable seat removes pressure points and hot spots by adjusting the amount of air contained in each bladder within the seat. Easy-to-reach rocker switches on the side of the seat control the built-in compressor, adding and bleeding off air with the quick push of a button to help relieve stress from the lower back, tail-bone or lower extremities. On a long run, occasionally inflating and deflating the air bladders reduces the "numb butt" effect by improving the blood flow to the extremities. So grab a seat. And enjoy the ride.

A. ROAD ZEPPELIN AIR ADJUSTABLE SEAT

The Road Zeppelin seat's ergonomically friendly design combines a narrow front nose for ease of touching the ground at a stop with a wide seating surface for long-range rider and passenger comfort. The easy-to-clean vinyl seat is finished with an embroidered Road Zeppelin logo that lets everyone see that you take riding comfort seriously. The slotted seat accepts an optional rider backrest or passenger grab rail for additional touring comfort.

52000201 \$796.95

Fits '08-later Touring and '09-later Tri Glide® models. '14-'16 models require separate purchase of Electrical Harness Extension P/N 69200722. '17-later models require Electrical Harness Extension P/N 69201599A. Installation on some '12-'13 CVO™ models requires removal of fender trim strips. Seat width 20.0"; passenger pillion width 14.5".

Passenger Zone

Press the 3rd button to inflate and deflate the passenger area, providing maximum comfort to the backbone and support to the thigh area.

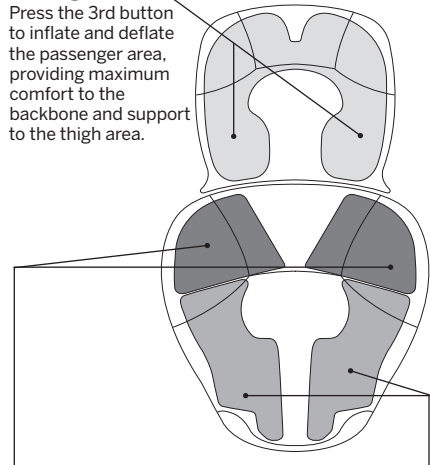

Lower Back Zones

Press the 2nd button (rider only) to adjust the support in the lower back zone chambers, relieving pressure points in the lower back.

Thigh Zones

Press the 1st button to adjust pressure in the two thigh zone chambers, improving blood flow to lower extremities and adding support to thighs.

B. HARLEY® HAMMOCK TOURING SEATS

Stay in the saddle all day. These Harley® Hammock Seats feature broad seating surfaces and a shallow bucket shape to distribute the weight and reduce pressure points. Beneath the 2" of traditional dual-density foam, the rider's weight is supported by a revolutionary fabric suspension system. The sling-like suspension system is integrated into the seat and acts like a hammock, providing 2" of suspension above the seat pan. This internal system prevents bottoming out and provides a 30% improvement in comfort and endurance over the long haul by sheltering the rider from pothole and highway expansion joint impacts. The generous seat length permits freedom of movement on long rides, making this seat a perfect option for taller riders.



A. ROAD ZEPPELIN AIR ADJUSTABLE SEAT



B. HARLEY HAMMOCK RIDER AND PASSENGER TOURING SEAT – '14-LATER MODELS



B. HARLEY HAMMOCK RIDER AND PASSENGER TOURING SEAT



B. HARLEY HAMMOCK RIDER AND PASSENGER TOURING SEAT – '97-'13 MODELS

TOURING & TRIKE 245

Seating – Harley® Hammock

B. HARLEY® HAMMOCK RIDER AND PASSENGER TOURING SEAT

Protect the backside of both rider and passenger from harsh road conditions. With its revolutionary suspension systems, this Harley® Hammock Rider and Passenger Touring Seat offers increased isolation from sharp road impacts. For the rider, sling-like fabric suspension system acts like a hammock to reduce impacts and the 2" of traditional foam on top provides additional support. For the passenger, a multiple spring-board style suspension system along with 2" of traditional foam provides 15% improvement in passenger comfort. When compared to the Hammock Seat offered on select '14-later CVO™ models, this Hammock Seat reduces the bucket shape to accommodate a wide variety of rider sizes and allows fore-and-aft movement to vary the position on a long ride. Available with or without dual-zone heated rider and passenger seating areas, this seat's vinyl surface is easy to clean and maintain. Can be equipped with Rider Backrest (sold separately) on most models.

Standard Harley Hammock Seat

52000566 Without Heat. \$628.95

Fits '14-later Touring and Tri Glide® models. Installation on '14-'20 Tri Glide models requires removal of grab rail. Seat width 17.0"; passenger pillion width 15.0"

52000567 Without Heat. \$628.95

Fits '09-'13 Touring and Trike models. Also fits '14-later Touring models not equipped with Tour-Pak® luggage. Trike models require separate purchase of Paint Guard Kit P/N 52000013. Does not fit models equipped with Passenger Grab Rail. Installation on '12-'20 CVO™ models requires removal of fender trim strips. Seat width 17.5"; passenger pillion width 15.0".

52000072 Without Heat. \$610.95

Fits '97-'07 Electra Glide® and Road Glide® models. Seat width 18.0"; passenger pillion width 15.5".

52000075 Without Heat. \$610.95

Fits '97-'07 Road King® and FLHX models. Seat width 18.0"; passenger pillion width 15.5".

Heated Harley Hammock Seat

Heated Harley Hammock seats feature switch-activated dual-zone controls for rider and passenger.

52000564 With Heat. \$983.95

Fits '14-later Touring® and Tri Glide models. '14-'16 models require separate purchase of Electrical Harness Extension P/N 69200722. '17-later models require Electrical Harness Extension P/N 69201599A. Installation on '14-'20 Tri Glide models requires removal of grab rail. Seat width 17.0"; passenger pillion width 15.0".

52000565 With Heat. \$983.95

Fits '09-'13 Touring and Trike models. Also fits '14-'20 Touring models not equipped with Tour-Pak® luggage. '14-'16 models require separate purchase of Electrical Harness Extension P/N 69200722. '17-later models require Electrical Harness Extension P/N 69201599A. Trike models require separate purchase of Paint Guard Kit P/N 52000013. Does not fit models equipped with Passenger Grab Rail. Installation on '12-'20 CVO™ models requires removal of fender trim strips. Seat width 17.5"; passenger pillion width 15.0".

Notice: The prices appearing in this catalog are the manufacturer's suggested retail prices. Actual retail prices may vary.

Notice: The prices appearing in this catalog are the manufacturer's suggested retail prices. Actual retail prices may vary.

246 TOURING & TRIKE

Seating – Sundowner™

SUNDOWNER™ SEATS

The Sundowner™ Seat provides the maximum in long-riding comfort. The deep-bucket design puts your body in the proper touring position and the generous padding makes it comfortable for both the rider and passenger as the miles are adding up. The dished shape provides added rider back support and the wide passenger pillion is shaped to minimize pressure points.

A. SUNDOWNER SEAT – SMOOTH

The smooth cover complements any Touring model. Seat accepts rider backrest for additional touring comfort.

52000128 **\$393.95**

Fits '14-later Touring and Tri Glide® models. Seat width 14.5"; passenger pillion width 13.0".

52093-08A **\$393.95**

Fits '08-'13 Touring and Trike models. Also fits '14-later Touring models not equipped with Tour-Pak® luggage. Installation on '12-later CVO™ models requires removal of fender trim strips. Seat width 16.0"; passenger pillion width 14.0".

51726-05 **\$393.95**

Fits '97-'07 Road King® and FLHX models. Also fits '97-'07 Electra Glide® and Road Glide® models equipped with Fuel Tank Console P/N 71288-03A or Trim Piece P/N 52447-96. Seat width 15.0"; passenger pillion width 12.0".

51542-01B **\$393.95**

Fits '97-'07 Electra Glide (except FLHX) and Road Glide models. Seat width 16.0"; passenger pillion width 13.5".

B. SUNDOWNER SEAT – FREEWHEELER®

This Sundowner seat is finished in rich black vinyl and is styled to complement the Freewheeler® Trike model's Original Equipment seat.

52000183 **\$393.95**

Fits '15-later FLRT models. Seat width 15.0"; passenger pillion width 11.0".

C. SUNDOWNER SEAT – ROAD KING® CLASSIC BASKETWEAVE

Decorated with a pleated leather valance and chrome Road King Classic concho, the seat stays true to Road King Classic styling. Accepts rider backrest for additional touring comfort.

51615-09A **\$432.95**

Fits '08-'13 Touring and Trike models. Also fits '14-later Touring models not equipped with Tour-Pak luggage. Installation on '12-later CVO models requires removal of fender trim strips. Seat width 16.0"; passenger pillion width 14.0".

51615-99C **\$432.95**

Fits '97-'07 Road King and FLHX models. Also fits '97-'07 Electra Glide and Road Glide models equipped with Fuel Tank Console P/N 71288-03A or Trim Piece P/N 52447-96. Seat width 15.0"; passenger pillion width 12.0".

D. SUNDOWNER™ SEAT – '06-'10 STREET GLIDE® STITCHING

Decorated with tuck and roll pleating, the Sundowner™ Seat complements the '06-'10 Street Glide® styling. Accepts rider backrest for additional touring comfort.

51630-09A **\$432.95**

Fits '08-'13 Touring and Trike models. Also fits '14-later Touring models not equipped with Tour-Pak® luggage. Installation on '12-later CVO™ models requires removal of fender trim strips. Seat width 16.0"; passenger pillion width 14.0".



A. SUNDOWNER SEAT – SMOOTH (52000128 SHOWN)



B. SUNDOWNER SEAT – FREEWHEELER



C. SUNDOWNER SEAT – ROAD KING CLASSIC BASKETWEAVE (51615-09A SHOWN)



D. SUNDOWNER SEAT – '06-'10 STREET GLIDE STITCHING (51630-09A SHOWN)



E. DRAG SEAT – GLOSS BLACK BASE



F. LEATHER BADLANDER SEAT



G. BADLANDER SEAT



H. LEATHER LOW-PROFILE BUCKET SEAT

TOURING & TRIKE 247

Seating – Low Profile

E. DRAG SEAT

For those who live for the moment red lights turn green, the Drag Seat is destined to keep the rider firmly planted in the bike under hard acceleration and maneuvering. The raised pillion of the Drag Seat provides increased support when you need it most. Structural ridges of foam provide increased grip without compromising comfort. The exposed light-weight aluminum seat pan provides a rigid foundation for the seat and offers better rider feedback from the vehicle under aggressive maneuvering. Seat Width: 12.33" Pillion Width: 9.74"

Fits '14-later Touring models. Does not fit Trike models. Does not fit models equipped with Passenger Grab Rails or vehicles equipped with Tour-Pak® luggage carrier.

52000461 Gloss Black Base. **\$693.95**

52000452 Brushed Aluminum Base. **\$693.95**

F. LEATHER BADLANDER® SEAT

The traditional Badlander® seat's low and lean style sets the stage for your minimalist custom ride. The frame-hugging rider seat and the slim tapered passenger pillion visually stretch the bike and enhance the slammed look. The seat shape stays low along its entire length and follows the lines of the bike with minimal disruption, and delivers a riding position that is lower and generally farther back than the stock seat. Ideal for both short riders needing to be closer to the ground, or for tall riders that want to bove back in the bike without sitting higher. This seat is wrapped in supple top-grain leather and finished with an embroidered Harley-Davidson script. Kit includes leather grab strap and mounting hardware.

52000257 **\$418.95**

Fits '08-later Touring models. Does not fit Trike models. Installation on '12-later CVO™ models requires removal of fender trim strips. Seat width 13.0"; passenger pillion width 6.0".

G. BADLANDER SEAT

Clean smooth covers, subtle top-stitching and a frame-hugging profile add up to a statement only Harley could create. The low design delivers a reduced seat height that is ideal for riders that want the shortest possible reach to the ground, and the long and lean shape allows tall riders to move back from the hand and foot controls without sitting higher on the bike. Kit includes grab strap and all mounting hardware. Does not accept a rider backrest.

52067-08A **\$337.95**

Fits '08-later Touring models. Does not fit Trike models. Installation on '12-later CVO models requires removal of fender trim strips. Seat width 13.0"; passenger pillion width 6.0".

52066-97C **\$337.95**

Fits '97-'07 Road King® (except FLHRS) and FLHX models. Also fits '97-'07 Electra Glide® and Road Glide® models equipped with Fuel Tank Console P/N 71288-03A or Trim Piece P/N 52447-96. Seat width 12.25"; passenger pillion width 4.5".

52265-01A **\$337.95**

Fits '97-'07 Electra Glide (except FLHX) and Road Glide models. Seat width 12.5"; passenger pillion width 4.5".

H. LEATHER LOW-PROFILE BUCKET SEAT

A custom-look low and slammed seat, with a bucket contour for added support. Features embroidered logo and an opening that receives a matching Rider Backrest.

52095-08A **\$378.95**

Fits '08-later Touring and Tri Glide® models. Installation on '12-later CVO models requires removal of fender trim strips. Seat width 15.0"; passenger pillion width 8.5".

NOTE: Some Harley-Davidson® seats are made of leather. Fine leathers or other natural materials WILL gain "character," such as wrinkles or wear, with age. This is normal. A fine, aged patina and character wrinkles are a sign of the extremely high-quality materials used to construct your seat or backrest. The appearance of scars or marks on the leather are a result of using natural leather panels and should not be thought of as an imperfection. Please use Harley-Davidson® Leather Protectant P/N 93600034 to protect your investment.

Notice: The prices appearing in this catalog are the manufacturer's suggested retail prices. Actual retail prices may vary.

Notice: The prices appearing in this catalog are the manufacturer's suggested retail prices. Actual retail prices may vary.

TOURING

248 TOURING & TRIKE

Seating – Low Profile

LOW-PROFILE SOLO TOURING SEATS AND PILLIONS

Set your custom bagger apart with a Low-Profile Solo Seat that combines street-rod style with a surprising touch of comfort. Start with a shape that distributes your weight across a wide surface area to reduce pressure points. Then, add a tapered nose that brings the legs closer together to shorten the reach to the ground. The result is the slammed custom seat that you crave, with enough comfort and support to let you actually spend time in the saddle. Finish the look with your choice of matching passenger pillion, sissy bar pad and Tour-Pak® carrier backrest pad.

A. LOW-PROFILE SOLO TOURING SEAT – SMOOTH VINYL

Wrapped in supple black vinyl, this Low-Profile Solo Seat is shaped to hug the frame and place the rider "in" the bike – not on top of it. The slight bucket shape cradles the rider, and keeps him or her from sliding rearward during acceleration.

52000249 **\$319.95**

Fits '09-later Touring models. Does not fit Trike models. Does not accept Rider Backrest. Seat width 15.0".

Shown with:

LOW-PROFILE PASSENGER PILLION – SMOOTH VINYL

Enveloped in smooth black vinyl, this Passenger Pillion is the perfect complement to the Smooth Vinyl Low-Profile Solo Seat. Easy on-and-off installation lets you change from a two-up tourer to a stripped-down cruiser in seconds. Includes matching grab strap.

52400141 **\$213.95**

Fits '09-later Touring models equipped with Solo Seat P/N 52000249. Pillion width 11.0". Does not fit Trike models.

B. LOW-PROFILE SOLO TOURING SEAT – BLACK DIAMOND

Swathed in textured black vinyl, this Low-Profile Solo Seat features a custom diamond-pleated seating surface highlighted with double-row toast-colored accent stitching. The rich materials add an elegant finish to your custom bagger.

52000248 **\$382.95**

Fits '09-later Touring models. Does not fit Trike models. Does not accept Rider Backrest. Seat width 15.0".

Shown with:

LOW-PROFILE PASSENGER PILLION – BLACK DIAMOND

Layered in a combination of smooth and textured black vinyl, this Passenger Pillion is the perfect complement to the Black Diamond Low-Profile Solo Seat. Easy on-and-off installation lets you change from a two-up tourer to a stripped-down cruiser in seconds. Includes matching grab strap.

52400140 **\$292.95**

Fits '09-later Touring models equipped with Solo Seat P/N 52000248. Pillion width 11.0". Does not fit Trike models.

C. LOW-PROFILE SOLO TOURING SEAT – MAHOGANY BROWN

Finished with a rich textured mahogany-brown vinyl and upholstered in a custom diamond-pleat pattern with complementing double-row gold stitching, this Low-Profile Solo Seat brings a non-traditional look to your Touring model.

52000057 **\$382.95**

Fits '09-later Touring models. Does not fit Trike models. Does not accept Rider Backrest. Seat width 15.0".

Shown with:

LOW-PROFILE PASSENGER PILLION – MAHOGANY BROWN

Dressed in rich textured brown vinyl and finished with elegant gold stitching, this Passenger Pillion is the perfect complement to the Mahogany Brown Solo Seat. Easy on-and-off installation lets you change from a two-up tourer to a stripped-down cruiser in seconds. Includes matching grab strap.

52400040 **\$292.95**

Fits '09-later Touring models equipped with Solo Seat P/N 52000057. Pillion width 11.0". Does not fit Trike models.



A. LOW-PROFILE SOLO TOURING SEAT – SMOOTH VINYL (SHOWN WITH LOW-PROFILE PASSENGER PILLION)



B. LOW-PROFILE SOLO TOURING SEAT – BLACK DIAMOND (SHOWN WITH LOW-PROFILE PASSENGER PILLION)



C. LOW-PROFILE SOLO TOURING SEAT – MAHOGANY BROWN (SHOWN WITH LOW-PROFILE PASSENGER PILLION)



D. PASSENGER GRAB RAIL – CHROME (52400090 SHOWN)



D. PASSENGER GRAB RAIL – GLOSS BLACK (52400091 SHOWN)



D. PASSENGER GRAB RAIL



E. PASSENGER HANDRAIL COVERS



F. QUICK-RELEASE SEAT HARDWARE KIT – CHROME



F. QUICK-RELEASE SEAT HARDWARE KIT – GLOSS BLACK



G. SEAT MOUNTING NUTS – GLOSS BLACK

TOURING & TRIKE 249

Seating – Accessories

D. PASSENGER GRAB RAIL

Add comfort and confidence for your riding companion. This easy-to-install handrail provides a convenient hand grip for your passenger and a secure tie-down point for pillion-mounted touring luggage.

Fits '14-later Touring and Tri Glide® models. Does not fit models equipped with Tallboy® Seat P/N 52000134 or Passenger Armrest Kit P/N 52400073 or FLHTKSE and FLTRUSE models with Original Equipment seat.

52400090 Chrome. **\$142.95**

52400091 Gloss Black. **\$139.95**

E. PASSENGER HANDRAIL COVERS

Beef up the look of the passenger handrail with these easy-to-install chrome-plated grips. The thick diameter offers a firm and comfortable hand hold for your passenger and features jet black rubber inserts, ball-milled grooves and Bar & Shield logo for added style. Kit includes right and left grip and stainless steel mounting hardware.

91668-05 **\$73.95**

Fits '99-'13 Touring models equipped with Passenger Grab Rails.

F. QUICK-RELEASE SEAT HARDWARE KIT

This Quick-Release Hardware Kit allows the rider to remove one-piece Harley-Davidson® seats quickly and easily. The knurled knob is easy to install or remove without tools, and the nylon washer keeps the finger tightened knob in place and rattle free. A raised-logo Harley-Davidson® emblem finishes the look. SAE 1/4"-20 thread.

Fits '97-later XG, XL, Dyna®, Softail® (except '12-'17 FLS models equipped with Original Equipment seat), Touring and Trike models equipped with SAE 1/4"-20 seat mount hardware. Does not fit seats equipped with spring-loaded rear seat bracket.

51676-97A Chrome. **\$23.95**

10500093 Gloss Black. **\$23.95**

G. SEAT MOUNTING NUTS – GLOSS BLACK

When blacking-out your bike, don't miss the details. These gloss black Seat Mounting Nuts take the hassle out of removing your two-piece seat and complete the blacked out look. These rich black caps dress up the seat mounting tab and the knurled knob makes fastening and unfastening the seat easy work. No tools required. Sold in pairs.

10400049 **\$28.95**

Fits all Softail and Touring models with Original Equipment or Genuine Motor Accessory 2-piece seat and knurled seat mounting nuts.

Notice: The prices appearing in this catalog are the manufacturer's suggested retail prices. Actual retail prices may vary.

Notice: The prices appearing in this catalog are the manufacturer's suggested retail prices. Actual retail prices may vary.

250 TOURING & TRIKE

Seating – Rider Backrests

A. ADJUSTABLE RIDER BACKRESTS

Add support for the long haul. With one quick pull from the integrated gas spring, you can instantly adjust the riding position through a 30-degree range. The backrest pad features a sleek shape that provides full lower back support without pushing the rider forward and a slim profile that offers the passenger a few more inches of space. The backrest features a pull knob-activated, five-position, 1.5" height adjustment. The backrest can be easily removed and folds down to allow easier passenger mounting.

Fits '97-later Touring and Trike models equipped with many one-piece slotted seats. This rider backrest may not look appropriate on select Original Equipment, CVO™ seats and accessory seats that are styled with a low-profile look. Installation requires separate purchase of model-specific Adjustable Rider Backrest Mounting Kit.

1. 52423-09A	Comfort Stitch Style.	\$124.95
2. 52591-09A	Road King® Classic Style.	\$139.95
3. 52546-09A	'06-'10 Street Glide® Style.	\$124.95
4. 52501-09A	Smooth Style.	\$124.95

Shown with:

ADJUSTABLE RIDER BACKREST MOUNTING KIT

Kit includes mounting bracket, adjustment handle and all required installation hardware.

52596-09A **\$235.95**
Required to install Adjustable Rider Backrest on '09-later Touring models. Does not fit Trike models.

54099-10 **\$235.95**
Required to install Adjustable Rider Backrest on '09-later Tri Glide® models. Also fits '15-later Freewheeler® models equipped with Sundowner™ Seat P/N 52000183.

52593-09A **\$235.95**
Required to install Adjustable Rider Backrest on '97-'08 Touring models.

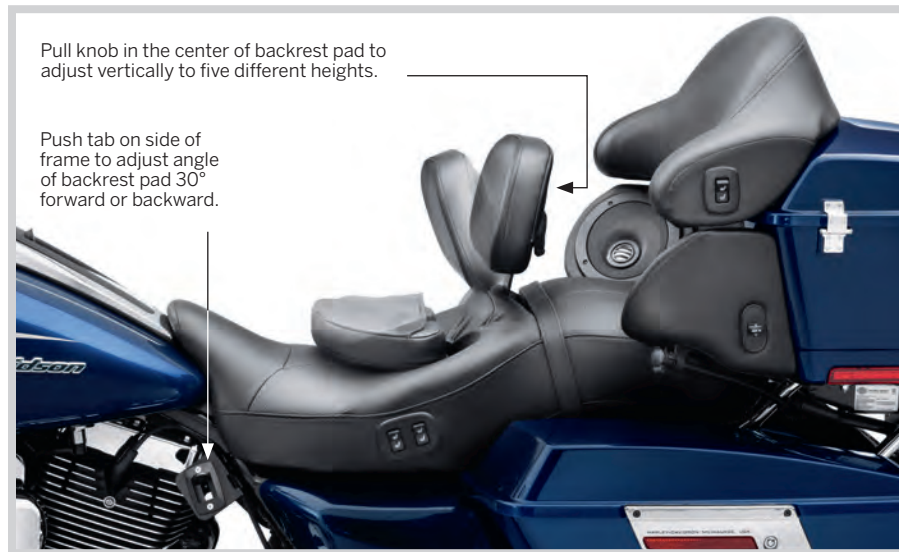

A. ADJUSTABLE RIDER BACKREST KITS



A. ADJUSTABLE RIDER BACKRESTS (SHOWN WITH MOUNTING KIT)

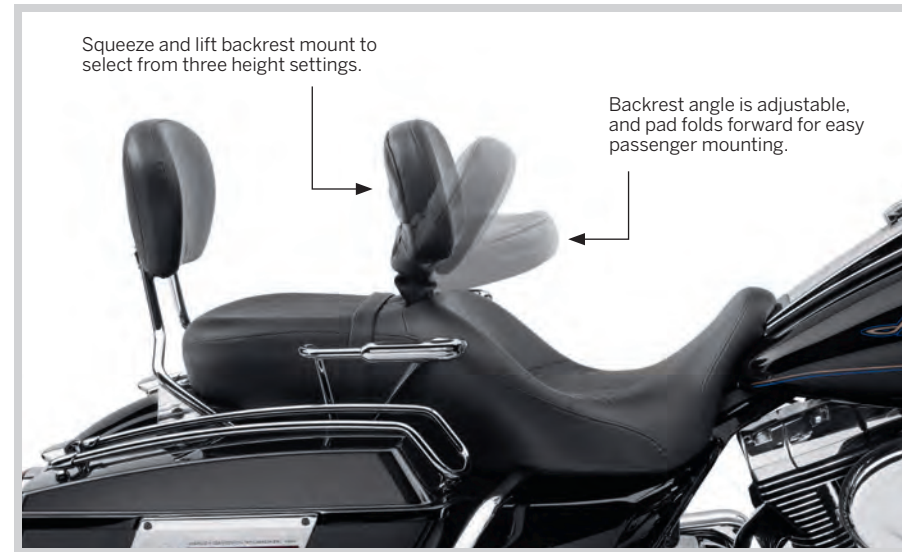

B. RIDER BACKREST



B. RIDER BACKRESTS (SHOWN WITH MOUNTING KIT)



C. RIDER BACKREST ORGANIZER

TOURING & TRIKE 251

Seating – Rider Backrests

B. RIDER BACKRESTS

Add back support for long-haul riding comfort. Contoured backrest pad is shaped to provide full lower back support without pushing the rider forward and the slim profile offers the passenger a few more inches of room. An adjustable support bracket with four mounting locations accommodates different seats and riding positions. The backrest pad angle can be adjusted for maximum comfort.

Fits '88-later Touring and Trike models equipped with one-piece slotted seat. Installation requires separate purchase of model-specific Rider Backrest Mounting Kit.

1. 52572-09A	Comfort Stitch Style.	\$213.95
2. 52583-09A	Road King® Classic Style.	\$213.95
3. 51631-09A	'06-'10 Street Glide® Style.	\$213.95
4. 52900-09A	Smooth Leather Style.	\$235.95
5. 52914-09A	Smooth Vinyl Style.	\$213.95

Shown with:

RIDER BACKREST MOUNTING KIT

Kit includes mounting bracket and all required installation hardware.

52589-09A **\$52.95**
Required to install rider backrest on '09-later Touring models. Does not fit Trike models.

52300642 **\$52.95**
Required to install rider backrest on '09-later Trike models.

52587-09 **\$52.95**
Required to install rider backrest on '88-'08 Touring models.

C. RIDER BACKREST ORGANIZER

Keep your passenger's essentials close at hand. Convenient storage system is form-fitted to the rider backrest, and provides easy access to a variety of on-road necessities. The two zippered pockets and mesh pouch offer plenty of room for a water bottle, cell phone, keys, registration papers, sunscreen and lip balm, and one zippered pocket features a headphone port for easy connection to a personal music device. The Organizer features side laces for secure installation, and a smooth vinyl face with no raised seams for rider comfort.

93300098 **\$127.95**
Fits '09-later models equipped with H-D® Rider Backrest.

252 TOURING & TRIKE

Seating Accessories

A. ROAD ZEPPELIN® SEAT PAD

Experience ultimate comfort. Designed to ensure hours of comfort in the saddle, Road Zeppelin® Seat Pads are equipped with a unique air bladder system that allows your weight to be supported evenly across the entire seating surface. Whether you have a low-profile seat or a larger, more comfortable seat, you will feel the benefits. This air bladder system is designed to reduce pressure points, provide shock absorption and reduce vibration. Unlike other mouth-inflated seat pads, the Road Zeppelin Pad features an easy-to-reach integrated hand pump and metered air release valve that permits quick and controllable adjustment. You can easily adjust the comfort and support while seated on the pad. The UV-stable and snag-resistant mesh cover allows air to circulate beneath the rider's body, reducing the temperature trapped between the rider and seat. Shaped to conform to most Harley-Davidson® seats, the pads feature adjustable mounting straps and a non-skid surface to keep them in place. The hand-washable seat pad can be deflated and rolled for compact storage.

52000327 Rider. **\$180.95**

Fits rider position on all models equipped with Original Equipment or accessory seats. Also fits passenger position on Touring models with large pillion area. Pad width – 14.0".

52400162 Passenger. **\$168.95**

Fits Original Equipment and accessory passenger pillions. Pad length – 12.0"; width – 9.0".



A. ROAD ZEPPELIN SEAT PAD



A. ROAD ZEPPELIN SEAT PAD



A. ROAD ZEPPELIN SEAT PAD

Mesh cover permits air circulation to reduce temperature trapped between the rider and the seat.

12 air pockets are designed to reduce pressure points and spread the rider's weight across a wide surface.

Hand-washable seat pad can be deflated and rolled for compact storage.

Inner bladder pockets are interconnected to create a balanced air cushion for optimal support.

Non-skid bottom pad and adjustable mounting straps hold the pad in place.

Ergonomic design for easy hand grip while working the pump

Leak-free twist air release valve for quick and controllable adjustment.

Integrated bulb-style air pump for easy inflation.

Notice: The prices appearing in this catalog are the manufacturer's suggested retail prices. Actual retail prices may vary.

TOURING & TRIKE 253

Seating Accessories

B. CIRCULATOR SEAT AND BACKREST PADS

Keep comfortable on your next long ride. These breathable Circulator Seat and Backrest Pads feature 3D construction that promotes air movement and reduces heat buildup where the rider's body touches the seat or backrest. Designed to keep the rider cool by reducing the perspiration buildup between you and the seating surface, the Circulator Pad can be installed and removed in seconds for easy cleaning. The low-profile design minimizes seat-height change compared to inflatable pads, while enhancing comfort with its shock-absorbing construction. Manufactured of UV-stable materials, these seat and backrest pads resist fading when exposed to the sun. Elastic under-seat strap and non-slip base provide secure installation and the available Circulator Passenger Pillion Pad attaches to the rider pad with hook-and-loop tabs.

51076-10 Large Seat Pad. **\$107.95**

Fits Softail®, Touring and Trike models with Original Equipment and accessory seats. Will not fit Bobber or Road Zeppelin® seats. 16.0" wide.

51078-10 Passenger Pillion Pad. **\$74.95**

Fits Original Equipment and accessory passenger pillions. 13.0" wide.

52300103 Wide Backrest Pad. **\$64.95**

Fits wide profile Rider and Passenger Backrest Pads up to 12.0" wide and 9.0" tall.

C. RAIN COVERS*

Featuring a handy storage sack, this black nylon, water-resistant, Cordura® cover packs easily and shelters your seat from the storm.

51638-97 Solo Seat. **\$33.95**

Fits H-D® solo seats (except XR and FLSTS).

52952-97 Seat with Rider Backrest. **\$43.95**

Fits H-D Touring and Trike seats. Fits with accessory rider backrest.

D. FLHT/FLTR TRIM PIECE

This top-stitched trim piece opens a new world to the Standard Electra Glide® and Road Glide® model owners, allowing fitment of Road King® seats.

52447-96 Fits '94-'07 FLHT and FLTR models. **\$33.95**



B. CIRCULATOR SEAT PADS (ROAD KING SHOWN)

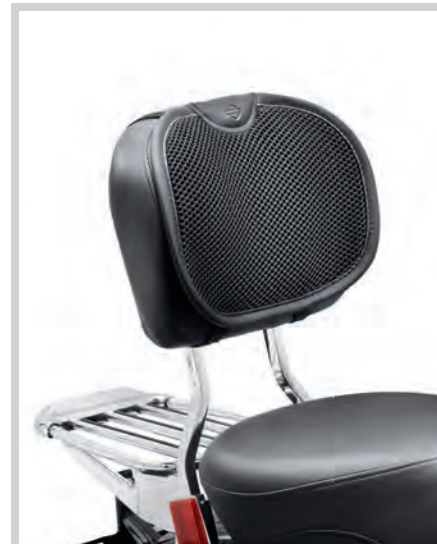

B. CIRCULATOR BACKREST PAD – WIDE



B. CIRCULATOR BACKREST PAD – WRAP AROUND



C. RAIN COVER – SEAT WITH RIDER BACKREST



D. FLHT/FLTR TRIM PIECE



***WARNING:** Do not use while riding; could result in death or serious injury.

Notice: The prices appearing in this catalog are the manufacturer's suggested retail prices. Actual retail prices may vary.

254 TOURING & TRIKE

Backrests & Racks

A. QUICK-RELEASE SISSY BAR UPRIGHT – FREEWHEELER® MODELS

Add passenger comfort and support to your Freewheeler® Trike model. Designed to blend with the curved lines of the trunk lid, the one piece upright slips into the docking ports and can be removed in seconds with a simple push of the release buttons. When the sissy bar is removed, you can pop in the included decorative caps for a clean custom look. The standard height upright accepts most mid-sized or oversized touring model passenger backrest pads (sold separately) and is the perfect finishing element for your long-distance touring machine. Available in your choice of mirror chrome or gloss black finish.

Fits '15-later FLRT models.		
52300324A	Chrome.	\$266.95
52300415	Gloss Black.	\$266.95

B. AIR WING LUGGAGE RACK – FREEWHEELER MODELS*

The low-profile aerodynamic styling of the Air Wing Luggage Rack draws your eye with its sleek lines and the engraved Harley-Davidson script adds a signature touch. This full-sized rack protects the trunk lid from scratches. The die-cast wing and lightweight steel tubing are hand-polished before finishing for long-lasting beauty. Kit includes all necessary mounting hardware.

50300097	Chrome.	\$213.95
Fits '15-later FLRT models.		
50300295	Gloss Black.	\$219.95
Fits '15-later FLRT and '23-later FLTRT models.		



A. QUICK-RELEASE SISSY BAR UPRIGHT – FREEWHEELER MODELS CHROME

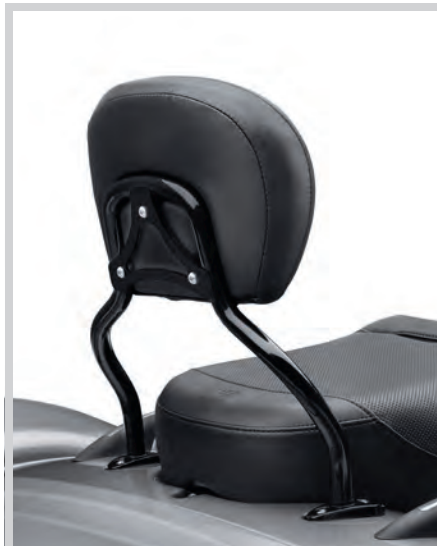

A. QUICK-RELEASE SISSY BAR UPRIGHT – FREEWHEELER MODELS GLOSS BLACK



B. AIR WING LUGGAGE RACK – FREEWHEELER MODELS – BLACK



B. AIR WING LUGGAGE RACK – FREEWHEELER MODELS



C. 4-POINT DOCKING HARDWARE KIT – CHROME '14-LATER MODELS



C. 4-POINT DOCKING HARDWARE KIT – GLOSS BLACK '14-LATER MODELS

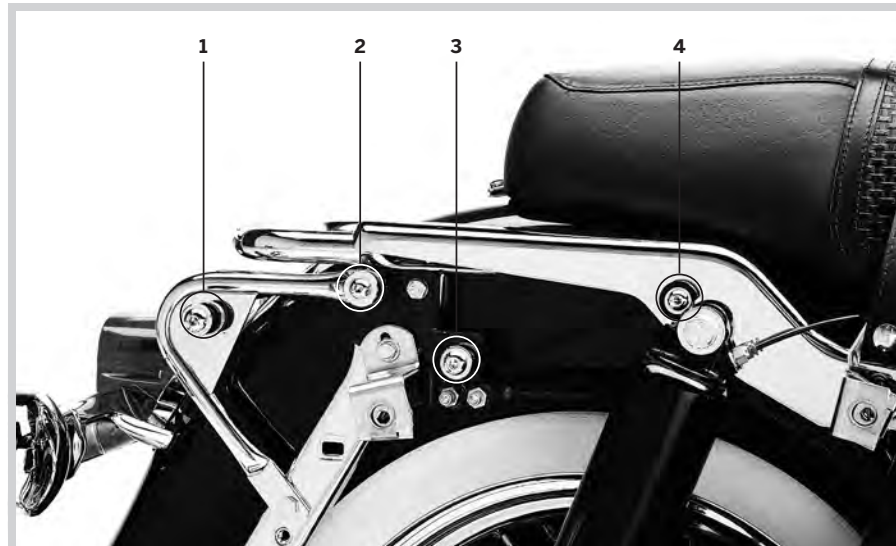

D. H-D DETACHABLES DOCKING HARDWARE KIT – '97-'08 TOURING MODELS



E. LOCKING H-D DETACHABLES LATCH KIT



F. H-D DETACHABLES LATCH KIT – CHROME

TOURING & TRIKE 255

Backrests & Racks

C. 4-POINT DOCKING HARDWARE KIT

The ideal choice for maximum versatility, this complete kit contains the docking hardware necessary to install all H-D® Detachables™ accessory options. Even if you only install a passenger backrest today, this kit allows you to add accessories as your touring demands change. Provides docking points to allow installation of H-D Detachables Sissy Bar, Solo Luggage Rack, Two-Up Luggage Rack, Solo Tour-Pak® Luggage Rack or Two-Up Tour-Pak Rack.

Fits '14-later Touring models (except models equipped with rigid-mount Tour-Pak luggage).

52300353	Chrome.	\$175.95
52300354	Gloss Black.	\$175.95

Fits '09-'13 FLHR, FLHRC, FLHT, FLHX, FLHXSE, FLTR, FLTRX and FLTRXSE, '13 FLHRSE and '09 FLTRSE models. For use with H-D Detachables Sissy Bars, Solo Luggage Racks, 2-Up Luggage Racks, Solo Tour-Pak Rack and 2-Up Tour-Pak Rack. FLHRC models require separate purchase of Saddlebag Hinge Stop P/N 90580-09.

54205-09A	Chrome.	\$185.95
54246-09A	Gloss Black.	\$185.95

D. H-D® DETACHABLES™ DOCKING HARDWARE KITS – '97-'08 TOURING MODELS

For Sissy Bar, Solo Luggage Rack or Solo Tour-Pak®
Kit contains the docking hardware necessary to install H-D® Detachables™ accessories on your Road King®, Road Glide®, Street Glide® or Electra Glide® Standard model. Provides docking points to allow installation of detachable Passenger Backrest, Solo Luggage Rack or Solo Tour-Pak® Rack.

53803-06	\$59.95
Fits '97-'08 Touring models (except FLHTCUI and '07-'08 FLHRSE).	

For Two-Up Tour-Pak or Two-Up Luggage Rack
Kit contains the docking hardware necessary to install H-D Detachables accessories on your Road King, Road Glide, Street Glide or Electra Glide Standard model. Provides docking points to allow installation of detachable Two-Up Luggage Rack or Two-Up Tour-Pak.

53804-06	\$78.95
Fits '97-'08 Touring models (except FLHTCUI and '07-'08 FLHRSE).	

Docking Hardware Fitment Matrix – '97-'08 Models

Touring Detachable	Docking Kit	Diagram
Sissy Bar Upright P/N 52933-97C, 52805-97B, 52935-04A or 52723-06A	53803-06	3 & 4
Two-Up Luggage Rack P/N 53743-97	53804-06	1 & 2
Two-Up Tour-Pak Rack P/N 53276-04A	53804-06	1 & 2
Solo Luggage Rack P/N 53048-06	53803-06	3 & 4

E. LOCKING H-D DETACHABLES LATCH KIT

This unique lock replaces the camlock on your H-D Detachables accessories, providing additional security and peace of mind when parking your vehicle. The kit includes two extended-reach barrel-style keys for easy access to the lock. Key registration and replacement service is available.

Fits all models equipped with detachable Sideplates, Racks and Tour-Pak Luggage Carriers (except '18-later Softail® models with HoldFast™ racks and uprights or '09-later Touring models equipped with detachable Solo Tour-Pak Rack).

92800008	Black.	\$78.95
-----------------	--------	----------------

F. H-D DETACHABLES LATCH KIT – CHROME

Decorative chrome latches are the perfect way to enhance the appearance of your detachable accessories. Meticulously polished and chrome-plated, these easy-to-install rotary latches are a direct replacement for the Original Equipment satin black parts and are a simple way to add a finishing touch to your ride. Latches feature an easy-to-pull finger release to simplify access in hard-to-reach areas.

12600036	\$54.95
Fits all models equipped with detachable Sideplates, One-Piece Sissy Bar Uprights, Racks, and Tour-Pak Luggage Mounting Racks (except '18-later Softail models with HoldFast racks and uprights).	



***WARNING:** Do not use this rack as a seat. Do not exceed the fender rack weight capacity. Using as seat or exceeding this capacity could cause handling problems, which could result in loss of control and death or serious injury.

Notice: The prices appearing in this catalog are the manufacturer's suggested retail prices. Actual retail prices may vary.

Notice: The prices appearing in this catalog are the manufacturer's suggested retail prices. Actual retail prices may vary.

256 TOURING & TRIKE

Backrests & Racks

A. H-D® DETACHABLES™ SISSY BAR UPRIGHT

A sissy bar and passenger backrest pad is the starting point for building a complete touring machine. The backrest provides long-range comfort and support and adds a feeling of confidence and control for the passenger. Available in your choice of height, these H-D® Detachables™ One-Piece Uprights can be installed or removed in seconds to add versatility to your ride. A wide variety of Backrest Pads are available for separate purchase.

Fits '09-later Touring models equipped with required Docking Hardware Kits. '09-later Touring models equipped with rigid-mount Tour-Pak® luggage require purchase of appropriate H-D Detachables Tour-Pak Conversion Kit.

52610-09A	Short – Chrome.	\$213.95
54248-09A	Short – Gloss Black.	\$213.95
52627-09A	Standard-Height – Chrome.	\$213.95
54247-09A	Standard-Height – Gloss Black.	\$213.95

Fits '97-'08 Road King®, FLHT, FLHX and FLTR models equipped with required Docking Kits. Fits '06-'08 FLHTC models equipped with H-D Detachables Tour-Pak Rack Mounting Kit P/N 53303-07A and Docking Hardware Kit P/N 53803-06.

52933-97C	Standard-Height – Chrome.	\$213.95
52723-06A	Tall – Chrome.	\$213.95



A. H-D DETACHABLES SISSY BAR UPRIGHT – '09-LATER TOURING MODELS



B. PREMIUM H-D DETACHABLES BACKREST WITH ADJUSTABLE RECLINE



TOURING & TRIKE 257

Backrests & Racks

B. PREMIUM H-D® DETACHABLES™ BACKREST WITH ADJUSTABLE RECLINE

Enhance your passenger's ride with an adjustable passenger backrest. This adjustable backrest allows the passenger to change the recline angle for maximum comfort. Simply turn the glove-friendly locking knobs and adjust the upright to one of three different recline settings. The 3 position settings provide 16 degrees of adjustment, with the mid position that matches a standard backrest recline. The exclusive cam lock H-D® Detachables™ design lets you add or remove the passenger backrest assembly in seconds. Available in chrome and gloss black finishes.

Fits '09-later Touring models equipped with required Docking Hardware Kits (except models equipped with Stealth Detach Luggage Rack). '09-later Touring models equipped with rigid-mount Tour-Pak® luggage require purchase of appropriate H-D Detachables Tour-Pak Conversion Kit.

52300257	Standard-Height – Chrome.	\$319.95
52300258	Standard-Height – Gloss Black.	\$319.95



A. SHORT H-D DETACHABLES SISSY BAR UPRIGHT – GLOSS BLACK



A. STANDARD-HEIGHT H-D DETACHABLES SISSY BAR UPRIGHT – CHROME



B. PREMIUM H-D DETACHABLES BACKREST WITH ADJUSTABLE RECLINE – CHROME



A. H-D DETACHABLES SISSY BAR UPRIGHT – '09-LATER MODELS



A. H-D DETACHABLES SISSY BAR UPRIGHT – '97-'08 MODELS



B. PREMIUM H-D DETACHABLES BACKREST WITH ADJUSTABLE RECLINE – GLOSS BLACK

Notice: The prices appearing in this catalog are the manufacturer's suggested retail prices. Actual retail prices may vary.

Notice: The prices appearing in this catalog are the manufacturer's suggested retail prices. Actual retail prices may vary.

258 TOURING & TRIKE

Backrests & Racks

A. PASSENGER BACKREST PAD – COMPACT

Sized to complement low-profile custom seats, this Compact Passenger Backrest Pad combines practical passenger support with custom compact style. Pads include mounting bracket and hardware required for attachment to sissy bar upright.

Fits '18-later Softail® models equipped with Short or Standard Height HoldFast™ Sissy Bar Uprights. Also fits Touring models equipped with Short H-D® Detachables™ Passenger Sissy Bar Upright P/N 52935-04A, 52610-09A or 54248-09A. Will not fit seats with tall passenger pillion pads. Pad height 3.75"; width 6.5".

52300559A	Smooth Black Vinyl.	\$69.95
52300558A	Fat Bob Styling.	\$79.95
52300556A	Fat Boy Styling.	\$79.95



A. PASSENGER BACKREST PAD – COMPACT
(52300559A SHOWN)



B. PASSENGER BACKREST PAD – MID-SIZED

Sized to fit both Low and Standard-Height HoldFast Sissy Bar Uprights, these Mid-Sized Backrest Pads feature a gentle curved shape that cradles the spine and provides hours of passenger comfort. Pad height 7.0"; width 6.5".

Fits '18-later Softail models equipped with Standard Height HoldFast Sissy Bar Uprights. Also fits Touring models equipped with Standard-Height H-D Detachables Passenger Sissy Bar Uprights P/N 52300324, 52627-09A, 54247-09A, 52933-97C or 52805-97B, Tall H-D Detachables Passenger Sissy Bar Upright P/N 52723-06A, Premium H-D Detachables Sissy Bar Upright 52300257 or 52300258.

52300560	Smooth Black Vinyl.	\$79.95
52300557	Low Rider Styling.	\$90.95



A. PASSENGER BACKREST PAD – COMPACT
(52300558A SHOWN)



A. PASSENGER BACKREST PAD – COMPACT
(52300556A SHOWN)

C. COMPACT PASSENGER BACKREST PAD

Sized to complement low-profile custom seats, this Compact Leather Backrest Pad combines practical passenger support with custom compact style. The leather cover with smooth insert complements both synthetic and leather seating surfaces.

52408-07A **\$213.95**
Fits Short H-D Detachables Passenger Sissy Bar Upright P/N 52935-04A. Also fits H-D Detachables Passenger Sissy Bar Upright P/N 52610-09A or 54248-09A with purchase of Billet Backrest Pad Mount P/N 53086-04 or Styled Backrest Pad Mount P/N 52825-05. Also fits '18-later Softail models equipped with Short or Standard Height HoldFast™ Sissy Bar Uprights. Will not fit seats with tall passenger pillion pads. Pad height 6.5"; width 10.5".

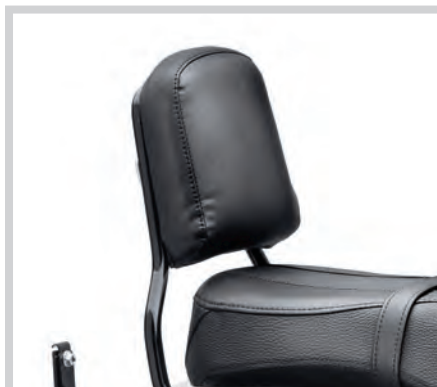

B. PASSENGER BACKREST PAD – MID-SIZED
(52300560 SHOWN)



B. PASSENGER BACKREST PAD – MID SIZED
(52300557 SHOWN)



C. COMPACT PASSENGER BACKREST PAD



D. SHORT PASSENGER BACKREST PAD – SMOOTH LOOK



E. SHORT PASSENGER BACKREST PAD – MAHOGANY BROWN



F. SHORT PASSENGER BACKREST PAD – '19 CVO STYLING



G. SHORT PASSENGER BACKREST PAD – CVO ROAD GLIDE CUSTOM STYLING



H. SHORT PASSENGER BACKREST PAD – CVO STREET GLIDE CUSTOM STYLING



I. STYLED BACKREST PAD MOUNT

TOURING & TRIKE 259

Backrests & Racks

D. SHORT PASSENGER BACKREST PAD – SMOOTH LOOK

Smooth top-stitched pad complements most seating surfaces.

51579-05A **\$118.95**
Fits Short H-D® Detachables™ Passenger Sissy Bar Upright P/N 52935-04A, 52610-09A or 54248-09A. Also fits '18-later Softail® models equipped with Short or Standard Height HoldFast™ Sissy Bar Uprights. Will not fit seats with tall passenger pillion pads. Pad height 6.5"; width 10.5".

E. SHORT PASSENGER BACKREST PAD – MAHOGANY BROWN

Dressed in rich textured brown vinyl and finished with elegant gold stitching, this Short Passenger Backrest Pad is the perfect complement to the Mahogany Brown Seat and Pillion collection. Styled to match the '12 FLTRXSE model.

52300141A **\$134.95**
Fits Short H-D Detachables Passenger Sissy Bar Upright P/N 52935-04A, 52610-09A or 54248-09A. Will not fit seats with tall passenger pillion pads. Also fits '18-later Softail® models equipped with Short or Standard Height HoldFast™ Sissy Bar Uprights. Pad height 6.5"; width 10.5".

F. SHORT PASSENGER BACKREST PAD – CVO™ STREET GLIDE® & CVO ROAD GLIDE® MODEL STYLING

Matches '18 or '19 CVO™ styling.

Fits Short H-D Detachables Passenger Sissy Bar Upright P/N 52935-04A, 52610-09A or 54248-09A. Also fits '18-later Softail models equipped with Short or Standard Height HoldFast Sissy Bar Uprights. Will not fit seats with tall passenger pillion pads. Pad height 6.5"; width 10.5"

52300573 '19 CVO models. **\$139.95**

G. SHORT PASSENGER BACKREST PAD – CVO ROAD GLIDE® CUSTOM STYLING

Matches '13 CVO Road Glide® Original Equipment seat. (except the 110th Anniversary edition CVO '13 FLTRXSE).

52300300 **\$139.95**
Fits Short H-D Detachables Passenger Sissy Bar Upright P/N 52935-04A, 52610-09A or 54248-09A. Will not fit seats with tall passenger pillion pads. Also fits '18-later Softail models equipped with Short or Standard Height HoldFast Sissy Bar Uprights. Pad height 6.5"; width 10.5".

H. SHORT PASSENGER BACKREST PAD – CVO STREET GLIDE CUSTOM STYLING

Matches '15 CVO Street Glide® Original Equipment seat.

52300361 **\$139.95**
Fits Short H-D Detachables Passenger Sissy Bar Upright P/N 52935-04A, 52610-09A or 54248-09A. Will not fit seats with tall passenger pillion pads. Also fits '18-later Softail models equipped with Short or Standard Height HoldFast Sissy Bar Uprights. Pad height 6.5"; width 10.5".

I. STYLED BACKREST PAD MOUNT

This custom Backrest Mounting Plate replaces the stamped metal mount for a distinctive look. The mirror-finished bracket, chrome-plated mounting hardware and Vivid Black insert contrasts with a leather or vinyl backrest pad to dress your Touring bike in style.

52825-05 **\$54.95**
Fits Touring models equipped with H-D Detachables Sissy Bar Upright P/N 52805-97B, 52935-04A, 52933-97C, 52723-06A, 52610-09A, 52627-09A, 52300257 or 52300258. Also fits '18-later Softail models equipped with HoldFast Sissy Bar Uprights (except if equipped with Compact Size Pad).

260 TOURING & TRIKE

Backrests & Racks

PASSENGER BACKREST PADS – MID-SIZED

Sized to fit Standard-Height and Tall Touring Sissy Bar Uprights. Available to match a wide variety of seat stitch designs, these Mid-Sized Backrest Pads feature a gentle curved shape that cradles the spine and provides hours of passenger comfort.

Fits Standard-Height H-D® Detachables™ Passenger Sissy Bar Uprights P/N 52300324, 52627-09A, 54247-09A, 52933-97C or 52805-97B, Tall H-D Detachables Passenger Sissy Bar Upright P/N 52723-06A, Premium H-D Detachables Sissy Bar Upright 52300257 or 52300258. Also fits '18-later Softail™ models equipped with Short or Standard Height HoldFast™ Sissy Bar Uprights. Pad height 8.0"; width 12.0".

A. MID-SIZED PASSENGER BACKREST PAD – LEATHER

Styled to match Leather Low-Profile Bucket Seat P/N 52918-98A.

52920-98B **\$134.95**



A. MID-SIZED PASSENGER BACKREST PAD – LEATHER

B. MID-SIZED PASSENGER BACKREST PAD – TOP-STITCHED

Smooth top-stitched pad complements most seating surfaces.

52924-98B **\$129.95**



B. MID-SIZED PASSENGER BACKREST PAD – TOP-STITCHED



C. MID-SIZED PASSENGER BACKREST PAD – COMFORT STITCH

C. MID-SIZED PASSENGER BACKREST PAD – COMFORT STITCH

Styled to match Comfort Stitch Seats and Rider Backrests.

51727-05A **\$124.95**

D. MID-SIZED PASSENGER BACKREST PAD – CUSTOM STITCHING

Styled to match Road King® Custom models.

52657-04B **\$118.95**

E. MID-SIZED PASSENGER BACKREST PAD – '06-'10 STREET GLIDE® STITCHING

Styled to match the '06-'10 Street Glide® model.

51633-06A **\$118.95**

PASSENGER BACKREST PADS – OVERSIZED

Sized to fit Standard-Height and Tall Touring Sissy Bar Uprights. Available to match a wide variety of seat stitch designs, these Oversized Backrest Pads feature a large surface area and a generous curved shape that surrounds the passenger's lower back and provides added support for hours in the saddle.

Fits Standard-Height H-D Detachables Passenger Sissy Bar Uprights P/N 52300324, 52627-09A, 54247-09A, 52933-97C or 52805-97B, Tall H-D Detachables Passenger Sissy Bar Upright P/N 52723-06A, Premium H-D Detachables Sissy Bar Upright 52300257 or 52300258. Also fits '18-later Softail models equipped with Short or Standard Height HoldFast Sissy Bar Uprights. Pad height 9.5"; width 13.5".

F. OVERSIZED PASSENGER BACKREST PAD – SMOOTH

Smooth top-stitched pad complements most seating surfaces.

52886-98D **\$118.95**



D. MID-SIZED PASSENGER BACKREST PAD – CUSTOM STITCHING



E. MID-SIZED PASSENGER BACKREST PAD – STREET GLIDE STITCHING

G. OVERSIZED PASSENGER BACKREST PAD – STUDDED

Styled to match studded Original Equipment Road King® and Road King Touring Seat P/N 51617-99C.

52709-97C **\$118.95**



F. OVERSIZED PASSENGER BACKREST PAD – SMOOTH



G. OVERSIZED PASSENGER BACKREST PAD – STUDDED

Notice: The prices appearing in this catalog are the manufacturer's suggested retail prices. Actual retail prices may vary.

TOURING & TRIKE 261

Backrests & Racks

H. ADJUSTABLE TWO-UP LUGGAGE RACK*

Expand your options at the push of a button. This stylish rack offers style, function and practicality in one. The Adjustable Two-Up Luggage Rack features telescoping side extensions that allow the rider to customize the rack's width in seconds. To accommodate a wide soft bag or duffel, just press the buttons, slide out the side extensions and increase the usable surface area by 50%. When an oversize rack is not required, just slide in the extensions for a clean look. The beefy rack accommodates a load capacity up to 30 pounds and the side rails feature convenient mounting points that easily accept bag tie-down straps and bungee cords. The H-D® Detachables™ rack can be completely removed from the bike in seconds and is designed to accept the internally wired LED Light Kit P/N 68065-10 or 68219-10 (sold separately) for added visibility from the rear. Rack Dimensions: 12.0" D x 12.75" W (Unexpanded); 12.0" D x 18.75" W (Expanded).

Fits '09-later Touring models equipped with 4-Point Docking Hardware Kits (except '09-later CVO™ models with rigid-mount Tour-Pak® luggage). Models equipped with Original Equipment rigid-mount Tour-Pak require purchase of appropriate H-D Detachables Tour-Pak Rack Kit. FLHX, FLHXS, FLHXST, FLTR, FLTRX and FLTRXST models require separate purchase of Antenna Relocation Kit or Hidden Antenna Kit. Some FLHRC EU registration plates may interfere with rack.

50300044B Chrome. **\$425.95**
50300076B Gloss Black. **\$425.95**

I. LED LIGHT KIT**

Fast-acting LED Light Kit operates as a supplemental rear running light and brake light. The high, center-mount position places the light in the line-of-sight of following vehicles and the bright, fast-acting red LED lamps get you noticed. Wiring is concealed inside the rack for a clean, custom installation. Available with red or smoked lens.

Fits '14-later Touring models equipped with Air Wing H-D Detachables Luggage Rack P/N 54283-09A and 50300008A and Adjustable Two-Up Luggage Rack P/N 50300044B or 50300076B. Does not fit CVO models.

68000111 Red Lens. **\$74.95**
68000116 Smoked Lens. **\$74.95**

Also available:

LED LIGHT KIT WIRING HARNESS

Required for installation of optional LED Light Kit on Luggage Racks and Passenger Backrests.

69200772 **\$21.95**

Fits '14-later Touring and Trike models equipped with Adjustable Luggage Rack P/N 50300044B or 50300076B, Air Wing Racks P/N 54283-09A, 50300008A, 79179-08 or 53000062 and Air Wing Passenger Backrests P/N 52300146 or 52300147.



H. ADJUSTABLE TWO-UP LUGGAGE RACK – FINGERTIP CONTROL



H. ADJUSTABLE TWO-UP LUGGAGE RACK – CHROME (CLOSED)



H. ADJUSTABLE TWO-UP LUGGAGE RACK – CHROME (OPEN)



H. ADJUSTABLE TWO-UP LUGGAGE RACK – GLOSS BLACK (OPEN)



I. LED LIGHT KIT

***WARNING:** Do not use this rack as a seat. Do not exceed the fender rack weight capacity. Using as seat or exceeding this capacity could cause handling problems, which could result in loss of control and death or serious injury.

****WARNING:** Disconnecting your DOT-required tail, brake and turn signal lighting could reduce your visibility to others and result in death or serious injury.

Notice: The prices appearing in this catalog are the manufacturer's suggested retail prices. Actual retail prices may vary.

262 TOURING & TRIKE

Backrests & Racks

A. AIR WING H-D® DETACHABLES™ TWO-UP LUGGAGE RACK*

The low-profile aerodynamic styling defines the look of this Luggage Rack. Designed to work with or without H-D® Detachables™ Passenger Backrests, this rack can be installed or removed from the Docking Hardware in seconds, creating a truly versatile ride. Available in mirror chrome or rich gloss black finish, the rack draws your eye with its sleek lines and the engraved Harley-Davidson script adds a signature touch. The die-cast wing and lightweight steel tubing are hand-polished before finishing for long-lasting beauty. For added visibility, the rack is designed to incorporate the internal wiring of the Air Wing Rack Light Kit (sold separately) for a clean look.

Fits '09-later Touring models equipped with 4-point Docking Hardware Kits. '09-later Touring models equipped with rigid-mount Tour-Pak® luggage require purchase of appropriate H-D Detachables Tour-Pak Conversion Kit. FLHX, FLHXS, FLHXST, FLTR, FLTRX and FLTRXST models require separate purchase of Antenna Relocation Kit or Hidden Antenna Kit. Some FLHRC EU registration plates may interfere with rack.

54283-09A	Chrome.	\$271.95
50300008A	Gloss Black.	\$271.95



A. AIR WING H-D DETACHABLES TWO-UP LUGGAGE RACK – CHROME

B. LED LIGHT KIT**

Fast-acting LED Light Kit operates as a supplemental rear running light and brake light. The high, center-mount position places the light in the line-of-sight of following vehicles and the bright, fast-acting red LED lamps get you noticed. Wiring is concealed inside the rack for a clean, custom installation. Available with red or smoked lens.

Fits '14-later Touring models equipped with Air Wing H-D Detachables Luggage Rack P/N 54283-09A and 50300008A and Adjustable Two-Up Luggage Rack P/N 50300044B or 50300076B. Does not fit CVO™ models.

68000111	Red Lens.	\$74.95
68000116	Smoked Lens.	\$74.95

Also available:

LED LIGHT KIT WIRING HARNESS

Required for installation of optional LED Light Kit on Luggage Racks and Passenger Backrests.

69200772	\$21.95
-----------------	----------------

Fits '14-later Touring and Trike models equipped with Adjustable Luggage Rack P/N 50300044B or 50300076B, Air Wing Racks P/N 54283-09A, 50300008A, 79179-08 or 53000062 and Air Wing Passenger Backrests P/N 52300146 or 52300147.



A. AIR WING H-D DETACHABLES TWO-UP LUGGAGE RACK – GLOSS BLACK



C. KING H-D DETACHABLES TWO-UP LUGGAGE RACK – CHROME



C. KING H-D DETACHABLES TWO-UP LUGGAGE RACK – GLOSS BLACK



D. STEALTH H-D DETACHABLES LUGGAGE RACK – CHROME



D. STEALTH H-D DETACHABLES LUGGAGE RACK – GLOSS BLACK



A. AIR WING LUGGAGE RACK (SHOWN WITH LED LIGHT KIT)



B. LED LIGHT KIT



E. H-D DETACHABLES TWO-UP LUGGAGE RACK – CHROME



F. H-D DETACHABLES SOLO LUGGAGE RACK - CHROME

TOURING & TRIKE 263

Backrests & Racks

C. KING H-D® DETACHABLES™ TWO-UP LUGGAGE RACK*

This stylish oversized King Two-Up Luggage Rack adds extra capacity for your cross-town or cross-country ride. The classic harp-shaped rack is constructed of large diameter steel rod, welded and perfectly polished for an elegant look. This rack is first in class with an increased load capacity up to 30 pounds. The large rack with side extensions offers a versatile flat load surface and the slotted side plates provide options for securing soft or rigid carrying bags. Designed to work with or without a H-D® Detachables™ Passenger Backrest, the rack can be installed or removed from the bike in seconds.

Fits '09-later Touring models equipped with 4-point Docking Hardware Kits. '09-later Touring models equipped with rigid-mount Tour-Pak® luggage require purchase of appropriate H-D Detachables Tour-Pak Conversion Kit. FLHX, FLHXS, FLTR and FLTRX models require separate purchase of Antenna Relocation Kit or Hidden Antenna Kit. Some FLHRC EU registration plates may interfere with rack.

50300054A	Chrome.	\$261.95
50300058A	Gloss Black.	\$261.95

D. STEALTH H-D DETACHABLES TWO-UP LUGGAGE RACK*

Style and practicality in one. This classic four-bar H-D Detachables Luggage Rack flows with the long and lean lines of today's custom rides. The rails and curving support blend together for an integrated floating look and the "stealth" hidden hardware adds to the clean design.

Fits '09-later Touring models equipped with 4-point Docking Hardware Kits (except '09-later Touring models equipped with Premium H-D Detachables Backrest with Adjustable Recline P/N 523000257 and 523000258). '09-later Touring models equipped with rigid-mount Tour-Pak luggage require purchase of appropriate H-D Detachables Tour-Pak Conversion Kit. FLHX, FLHXS, FLTR and FLTRX models require separate purchase of Antenna Relocation Kit or Hidden Antenna Kit. Some FLHRC EU registration plates may interfere with rack.

53472-09A	Chrome.	\$357.95
53566-09A	Gloss Black.	\$347.95

E. H-D DETACHABLES TWO-UP LUGGAGE RACK*

Smooth sweeping curves and a brilliant chrome finish defines the look of this Luggage Rack. Available in chrome or gloss black finish, this sleek and functional rack is an elegant solution for carrying your luggage across the country. Designed to work with or without H-D Detachables Passenger Backrests, this rack can be installed or removed from the Docking Hardware in seconds, creating a truly versatile ride.

Fits '09-later Touring models equipped with 4-point Docking Hardware Kits. '09-later Touring models equipped with rigid-mount Tour-Pak luggage require purchase of appropriate H-D Detachables Tour-Pak Conversion Kit. FLHX, FLHXS, FLHXST, FLTR, FLTRX and FLTRXST models require separate purchase of Antenna Relocation Kit or Hidden Antenna Kit. Some FLHRC EU registration plates may interfere with rack.

54215-09A	Chrome.	\$240.95
50300042A	Gloss Black.	\$240.95

F. H-D DETACHABLES SOLO LUGGAGE RACK*

Add touring capabilities to your solo seat-equipped model in less than 60 seconds. This H-D Detachables Solo Rack fits over the fender when the passenger pillion is removed. The rack features sweeping curved rails and the chrome finish adds a stylish flair. Easily interchangeable with H-D Detachables Passenger Sissy Bar Upright.

54213-09A
Fits '09-later FLHR, FLHRC, FLHRXS, FLHT, FLHX, FLHXS, FLHXSE, FLTR, FLTRX, FLTRXSE, '13 FLHRSE and '09 FLTRSE models equipped with a solo seat. Requires separate purchase of a 2-Point or 4-Point Docking Hardware Kit.

***WARNING:** Do not use this rack as a seat. Do not exceed the fender rack weight capacity. Using as seat or exceeding this capacity could cause handling problems, which could result in loss of control and death or serious injury.

***WARNING:** Do not use this rack as a seat. Do not exceed the fender rack weight capacity. Using as seat or exceeding this capacity could cause handling problems, which could result in loss of control and death or serious injury.

****WARNING:** Disconnecting your DOT-required tail, brake and turn signal lighting could reduce your visibility to others and result in death or serious injury.

Notice: The prices appearing in this catalog are the manufacturer's suggested retail prices. Actual retail prices may vary.

Notice: The prices appearing in this catalog are the manufacturer's suggested retail prices. Actual retail prices may vary.

264 TOURING & TRIKE

Tour-Pak® Luggage Accessories

KING TOUR-PAK® LUGGAGE BACKREST PADS

Wrap-around King Tour-Pak® Luggage Backrest Pads are shaped to surround your passenger in comfort. The curved shape cradles the back and the integrated side wings fit naturally beneath your passenger's arms for added support. These backrests feature easy-to-install isolation mounts to reduce contact between the pad and the Tour-Pak luggage. King Backrest Pads are available in a variety of styles to match most seating surfaces.

A. SUN RAY® HEATED KING TOUR-PAK® LUGGAGE BACKREST PAD

Take the chill out of cool spring days and brisk fall nights with a heated wrap-around backrest pad. The Sun Ray® Pad features a convenient high/low/off toggle control that directs two levels of soothing warmth right where you need it. This one-piece pad with integrated heat element and thermostatic control system is simple to install and the heating element is switched off with the ignition to avoid draining the battery. Available in Smooth or Comfort Stitch styles, this pad can be teamed with a Sun Ray or Harley® Hammock Heated Seat for the ultimate in back and bottom comfort.

52300317 Comfort Stitch. **\$372.95**
Fits '14-later Touring and Tri Glide® models equipped with King Tour-Pak® luggage. '14-'16 models require separate purchase of Electrical Harness Extension P/N 69200722. '17-later models require Electrical Harness Extension P/N 69201599A.

B. KING TOUR-PAK LUGGAGE BACKREST PAD – COMFORT STITCH

Styled to match the Comfort Stitch Touring Seat series.

52300314 **\$288.95**
Fits '14-later Touring and Tri Glide models equipped with King Tour-Pak luggage.

52395-03B **\$288.95**
Fits '97-'13 Touring and Trike models equipped with King Tour-Pak luggage.

C. KING TOUR-PAK LUGGAGE BACKREST PAD – SMOOTH

Clean, smooth styling complements most seating surfaces.

52300312 **\$263.95**
Fits '14-later Touring and Tri Glide models equipped with King Tour-Pak luggage.

52892-98B **\$263.95**
Fits '97-'13 Touring and Trike models equipped with King Tour-Pak luggage.



A. SUN RAY HEATED KING TOUR-PAK BACKREST PAD – COMFORT STITCH '14-LATER MODELS



B. KING TOUR-PAK BACKREST PAD – COMFORT STITCH '14-LATER MODELS



B. KING TOUR-PAK BACKREST PAD – COMFORT STITCH '97-'13 MODELS



C. KING TOUR-PAK BACKREST PAD – SMOOTH '14-LATER MODELS



C. KING TOUR-PAK BACKREST PAD – SMOOTH '97-'13 MODELS



D. CHOPPED TOUR-PAK BACKREST PAD – SMOOTH '14-LATER MODELS



E. CHOPPED TOUR-PAK BACKREST PAD – '19 CVO STYLING



F. CHOPPED TOUR-PAK BACKREST PAD – '18 CVO STYLING



G. CHOPPED TOUR-PAK BACKREST PAD – '15 CVO STREET GLIDE STYLING



H. RAZOR-PAK BACKREST PAD – SMOOTH



I. KING TOUR-PAK BACKREST PAD – '19 CVO STYLING



J. KING TOUR-PAK BACKREST PAD – '15 CVO STREET GLIDE STYLING

TOURING & TRIKE 265

Tour-Pak® Accessories

CHOPPED TOUR-PAK® LUGGAGE BACKREST PADS

Chopped Tour-Pak® Luggage Backrest Pads provide deep padded support for your passenger and a low-profile shape that complements the low, lean look of your Tour-Pak luggage. Easy to install, the floating design of the integrated mounts reduce the contact between the pad and the Tour-Pak carrier to minimize paint scuffing. Chopped Backrest Pads are available in a wide variety of styles to match most seating surfaces.

D. CHOPPED TOUR-PAK LUGGAGE BACKREST PAD – SMOOTH

Clean, smooth styling complements most seating surfaces.

52300319 **\$185.95**
Fits '14-later Touring and Tri Glide® models equipped with Chopped Tour-Pak luggage.

52898-98A **\$185.95**
Fits '97-'13 Touring models equipped with Chopped Tour-Pak luggage.

E. CHOPPED TOUR-PAK BACKREST PAD – '19 CVO™ MODELS STYLING

Matches '19 CVO™ Original Equipment seat.

52300572 **\$225.95**
Fits '14-later Touring and Tri Glide models equipped with Chopped Tour-Pak luggage.

F. CHOPPED TOUR-PAK BACKREST PAD – CVO STREET GLIDE® & CVO ROAD GLIDE® MODELS STYLING

Matches '18 CVO Street Glide® and Road Glide® Original Equipment seat.

52300567 **\$225.95**
Fits '14-later Touring models equipped with Chopped Tour-Pak luggage.

G. CHOPPED TOUR-PAK BACKREST PAD – CVO STREET GLIDE STYLING

Matches '15-'16 CVO™ Street Glide Original Equipment seat.

52300359 **\$225.95**
Fits '14-later Touring and Tri Glide models equipped with Chopped Tour-Pak luggage.

H. RAZOR-PAK BACKREST PAD – SMOOTH

Clean, smooth styling complements most seating surfaces.

79192-10 **\$160.95**
Fits '97-'13 models equipped with Razor-Pak luggage.

I. KING TOUR-PAK® LUGGAGE BACKREST PAD – '19 CVO™ MODELS STYLING

Matches '19 CVO™ Original Equipment seat.

52300574 **\$372.95**
Fits '14-later Touring and Tri Glide® models equipped with King Tour-Pak® Luggage.

J. KING TOUR-PAK LUGGAGE BACKREST PAD – CVO STREET GLIDE STYLING

Matches '15-'16 CVO Street Glide® Original Equipment seat.

52300360 **\$346.95**
Fits '14-later Touring and Tri Glide models equipped with King Tour-Pak Luggage.

Notice: The prices appearing in this catalog are the manufacturer's suggested retail prices. Actual retail prices may vary.

Notice: The prices appearing in this catalog are the manufacturer's suggested retail prices. Actual retail prices may vary.

266 TOURING & TRIKE

Tour-Pak® Racks

H-D® DETACHABLES™ TOUR-PAK® LUGGAGE MOUNTING RACKS

Fully loaded, stripped down or anywhere in between, you can tailor your Harley-Davidson® Touring motorcycle to meet the demands of the highway. With H-D® Detachables™ docking hardware, you can transform your ride in the blink of an eye. Switch from a comfortable passenger backrest to load-hauling Tour-Pak® luggage in seconds. You can easily remove the Tour-Pak luggage for easy maneuverability around town and reinstall it for an epic ride across the country. It's your choice and Harley-Davidson provides the flexibility to do it your way.

A. H-D DETACHABLES SOLO TOUR-PAK LUGGAGE MOUNTING RACK*

The Solo Tour-Pak luggage Rack moves a Razor-Pak, Chopped or King Tour-Pak luggage forward to a comfortable back-supporting position. The rack is designed to position the Tour-Pak luggage for solo riding and is adjustable over a .75" range. Simply remove the Tour-Pak luggage from the convenient H-D® Detachables™ docking hardware, add a passenger pillion and the bike is ready for two-up riding. Tour-Pak, Backrest Pad and Docking Hardware sold separately.

53000225 Chrome. **\$235.95**

Fits '14-later Touring models equipped with a solo seat. All models require separate purchase of Docking Hardware Kit and Hidden AM/FM/WB Antenna P/N 76000862. Vehicles with stock Tour-Pak require purchase of Tour-Pak Luggage Conversion Kit P/N 53000291A. Chopped Tour-Pak luggage requires separate purchase of Tour-Pak Spacer Kit P/N 53000461. Not for use with Three-Pocket Fairing Pouch P/N 93300054B if used with Docking Kit P/N 52300131. Does not work with Boom!™ Audio Stage II Tour-Pak Speaker Kit P/N 76000526A.

53260-09B Chrome. **\$235.95**

Fits '09-'13 FLHR, FLHRC, FLHT, FLHX, FLHXSE, FLTR, FLTRX and FLTRXSE, '13 FLHRSE and '09 FLTRSE models. Requires separate purchase of 2-Point or 4-Point Docking Hardware Kit. FLHX and FLTR models require separate purchase of Tour-Pak Antenna Relocation Kit P/N 76556-09. '13 FLHRSE, '10-'12 FLHXSE, '09 FLTRSE and '12-'13 FLTRXSE models require separate purchase of Hidden AM/FM/WB Antenna Kit P/N 76000863.



RACK INSTALLED



RACK REMOVED



A. H-D DETACHABLES SOLO TOUR-PAK MOUNTING RACK



B. H-D DETACHABLES TWO-UP TOUR-PAK MOUNTING RACK – CHROME



B. H-D DETACHABLES TWO-UP TOUR-PAK MOUNTING RACK – GLOSS BLACK



TOURING & TRIKE 267

Tour-Pak® Racks

B. H-D® DETACHABLES™ TWO-UP TOUR-PAK® LUGGAGE MOUNTING RACK*

Change your riding style in less than 60 seconds. The ultimate in touring flexibility, this Tour-Pak® Luggage Rack makes the convenience and protection of a Razor-Pak, Chopped, King or Leather Tour-Pak Luggage System a simple on-and-off proposition. Simple turn latches mount the rack to the bike's docking points and allow you to replace the Tour-Pak luggage with a detachable sissy bar upright for around-town cruising. The mounting rack positions a Tour-Pak behind the passenger pillion and allows the passenger to use the luggage as a supporting backrest. Adjustable over a .75" range, the Tour-Pak can be located for maximum passenger room and comfort. Tour-Pak, Passenger Backrest Pad and Docking Hardware Kit sold separately.

Fits '14-later FLHR, FLHRC, FLHRXS, FLHRSE, FLHT, FLHX, FLHXS, FLHXSE, FLHXST, FLTRXST, FLTRX and FLTRXS models. Requires separate purchase of Docking Hardware Kit. Street Glide® and Road Glide® models require Hidden AM/FM/WB Antenna P/N 76000862 or Antenna Relocation Kit P/N 76000582. Does not work with Boom!™ Audio Stage II Tour-Pak Speaker Kit P/N 76000526A.

53000221 Chrome. **\$225.95**

53000459 Gloss Black. **\$225.95**

Fits '09-'13 FLHR, FLHRC, FLHT, FLHX, FLHXSE, FLTR, FLTRX and FLTRXSE and '09 FLTRSE models. Requires separate purchase of 2-Point or 4-Point Docking Hardware Kit. FLHX and FLTR models require separate purchase of Hidden AM/FM/WB Antenna Kit P/N 76000863. '10-'12 FLHXSE, '09 FLTRSE and '12-'13 FLTRXSE models require separate purchase of Hidden AM/FM/WB Antenna Kit P/N 76000863.

53276-09B Chrome. **\$225.95**

Fits '97-'08 Road King®, FLHT, FLHX and FLTR models equipped with required docking hardware. FLTR and FLHX models require Antenna Relocation Kit P/N 76326-00A. Does not fit with Layback License Plate Mounting Kit P/N 53385-00. Some EU registration plates may interfere with Tour-Pak Rack. Models with rear fender tip trim can be adapted with the separate purchase of License Plate Relocation Kit P/N 60095-00A.

53276-04A Chrome. **\$225.95**



***WARNING:** Do not use this rack as a seat. Do not exceed the fender rack weight capacity. Using as seat or exceeding this capacity could cause handling problems, which could result in loss of control and death or serious injury.



A. H-D DETACHABLES SOLO TOUR-PAK MOUNTING RACK – '14-LATER MODELS



A. H-D DETACHABLES SOLO TOUR-PAK MOUNTING RACK – '09-'13 MODELS



B. H-D DETACHABLES TWO-UP TOUR-PAK MOUNTING RACK – '14-LATER MODELS



B. H-D DETACHABLES TWO-UP TOUR-PAK MOUNTING RACK – '09-'13 MODELS

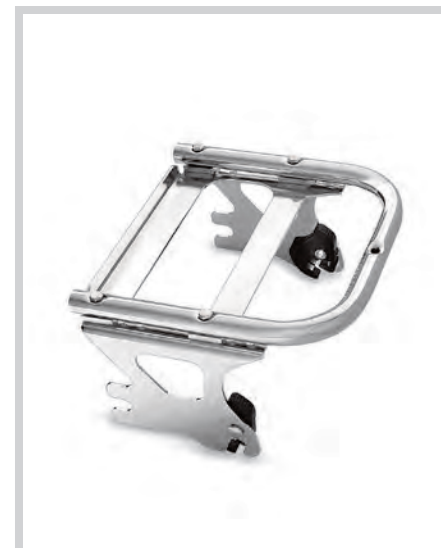

B. H-D DETACHABLES TWO-UP TOUR-PAK MOUNTING RACK – '97-'08 MODELS



***WARNING:** Do not use this rack as a seat. Do not exceed the fender rack weight capacity. Using as seat or exceeding this capacity could cause handling problems, which could result in loss of control and death or serious injury.

Notice: The prices appearing in this catalog are the manufacturer's suggested retail prices. Actual retail prices may vary.

Notice: The prices appearing in this catalog are the manufacturer's suggested retail prices. Actual retail prices may vary.

268 TOURING & TRIKE

Tour-Pak® Racks

A. H-D DETACHABLES TOUR-PAK® LUGGAGE CARRIER CONVERSION KIT

This kit includes everything needed to convert the rigid-mount Tour-Pak® luggage carrier to an easy on-and-off detachable version, and includes a Turn Signal Relocation Kit using the Signature LED Saddlebag Run/Brake/Turn lamps. This complete kit also includes a Docking Hardware Kit, H-D® Detachables™ Two-Up Tour-Pak® Luggage carrier Mounting Rack, and License Plate Relocation Kit. This kit is offered with either Chrome or Black mounting hardware.

Fits '14-later FLHTCU, FLHTCUL, FLHTK, FLHTKL, FLHTKSE, FLTRK, FLTRKSE, FLTRU and FLTRUSE models (except models equipped with CB antenna). Does not fit models equipped with Boom!™ Audio Stage II Tour Pak Luggage Carrier Speaker Kits. Not compatible with Air Wing or Stealth Detachable Luggage racks.

53000917 Chrome. **\$592.95**

B. H-D DETACHABLES TOUR-PAK LUGGAGE CARRIER CONVERSION KIT¹ – '97-'13

Transform your Electra Glide model for around-town cruising. This kit includes everything needed to convert the rigid-mount Tour-Pak luggage carrier to an easy on-and-off detachable version. Complete kit includes two-up docking hardware kit, H-D Detachables Two-Up Tour-Pak Rack, chrome license plate holder, reflector and AM/FM antenna relocation hardware.

53246-09C **\$604.95**

Fits '09-'13 FLHTC, FLHTCU, FLHTK and FLTRU models. FLHTCU and FLHTK require separate purchase of Wiring Harness P/N 70032-09. FLTRU models require separate purchase of Wiring Harness P/N 69200181.

53303-07A **\$362.95**

Fits '97-'08 FLHTC models. '97-'05 models require separate purchase of Light Harness Kit P/N 70113-08.

Also available: TOUR-PAK QUICK-DISCONNECT HARNESS FOR ULTRA MODELS

Wiring Harness Kit allows the installation of Detachable Tour-Pak Rack Kit on specified models.

70113-08 **\$18.95**

Fits '97-'05 FLHTC models equipped with Detachable Tour-Pak Kit P/N 53303-07A.



A. H-D DETACHABLES TOUR-PAK® LUGGAGE CARRIER CONVERSION KIT



A. H-D DETACHABLES TOUR-PAK® LUGGAGE CARRIER CONVERSION KIT – CHROME



A. H-D DETACHABLES TOUR-PAK® LUGGAGE CARRIER CONVERSION KIT – GLOSS BLACK



B. H-D DETACHABLES TOUR-PAK CONVERSION KIT – '09-'13 MODELS



B. H-D DETACHABLES TOUR-PAK CONVERSION KIT – '97-'08 MODELS



C. AIR WING TOUR-PAK LUGGAGE RACK – CHROME



C. AIR WING TOUR-PAK LUGGAGE RACK – GLOSS BLACK



D. AIR WING RACK LED LIGHT KIT – SMOKED LENS



D. AIR WING RACK LED LIGHT KIT – RED LENS

TOURING & TRIKE 269

Tour-Pak® Racks

C. AIR WING TOUR-PAK® LUGGAGE RACK*

The low-profile aerodynamic styling of the Air Wing Tour-Pak® Luggage Rack enhances the look of any Razor-Pak, Chopped or King Tour-Pak lid. Available in mirror chrome or rich gloss black finish, the rack draws your eye with its sleek lines and the engraved Harley-Davidson script adds a signature touch. This full-sized rack protects both Tour-Pak carrier's lid and passenger backrest from scratches. The die-cast wing and lightweight steel tubing are hand-polished before finishing for long-lasting beauty. Kit includes all necessary mounting hardware. For added visibility, the rack is designed to incorporate the internal wiring of the Air Wing Rack Light Kit (sold separately) for a clean look.

Fits King, Chopped and Razor-Pak Tour-Pak carrier lids. Mounting hole pattern matches Premium Tour-Pak Luggage Rack P/N 53665-87.

79179-08 Chrome. **\$213.95**

53000063 Gloss Black. **\$218.95**

D. AIR WING RACK LED LIGHT KIT

Custom fit to the Air Wing Tour-Pak Rack, this fast-acting LED Light Kit operates as a supplemental rear running light and brake light. The high, center-mount position places the rear light in the line-of-sight of following vehicles and the bright, fast-acting LED lamps get you noticed. Wiring is concealed inside the rack tubes for a clean, custom installation.

Fits '14-later Touring and Tri Glide® models equipped with Air Wing Tour-Pak Luggage Rack P/N 79179-08 or 53000063. Also fits '14-later FLHTKSE and '15-later FLTRUSE models with Original Equipment Tour-Pak Rack.

68000113 Smoked Lens. **\$74.95**

68000112 Red Lens. **\$74.95**

Fits '97-'13 Touring models equipped with Air Wing Tour-Pak Luggage Rack P/N 79179-08 or 53000063. Also fits '09-'13 FLHTCUSE models with Original Equipment Touring Rack.

68250-08A Red Lens. **\$74.95**



1 WARNING: Do not use this rack as a seat. Do not exceed the fender rack weight capacity. Using as seat or exceeding this capacity could cause handling problems, which could result in loss of control and death or serious injury.



2 WARNING: Disconnecting your DOT-required brake lamp could reduce your visibility to others and result in death or serious injury.



***WARNING:** Do not use this rack as a seat. Do not exceed the fender rack weight capacity. Using as seat or exceeding this capacity could cause handling problems, which could result in loss of control and death or serious injury.

Notice: The prices appearing in this catalog are the manufacturer's suggested retail prices. Actual retail prices may vary.

Notice: The prices appearing in this catalog are the manufacturer's suggested retail prices. Actual retail prices may vary.

270 TOURING & TRIKE

Tour-Pak® Racks

A. STEALTH TOUR-PAK® LUGGAGE RACK*

Style and practicality in one. This classic six-bar Tour-Pak® luggage rack flows with the long and lean lines of today's custom rides. The cantilevered aerodynamic rails appear to float above the center spar, imparting a lighter-than-air profile. Hidden hardware adds to the clean design. The Stealth Rack mounts in the same position as the Original Equipment Ultra Limited rack or the accessory Premium and Air Wing Tour-Pak luggage racks, so no additional drilling is required on those models. Use Bungee Cord Soft-Hook Extensions P/N 52300140 to keep your luggage firmly in place.

Fits King, Chopped and Razor-Pak Tour-Pak® carrier lids. Does not fit with Color-Matched Tour-Pak® Spoiler kits.

53000242	Chrome.	\$255.95
53000247	Gloss Black.	\$255.95



A. STEALTH TOUR-PAK LUGGAGE RACK – CHROME



A. STEALTH TOUR-PAK LUGGAGE RACK – GLOSS BLACK

B. PREMIUM TOUR-PAK LUGGAGE RACK*

This full-sized rack is especially designed to complement Tour-Pak lids with armrest-style passenger backrests. Protects both Tour-Pak carrier's lid and passenger backrest from scratches. Lightweight steel tubing incorporates high-quality welded joints and is hand-polished and chrome-plated using copper as a base coat followed by nickel and chrome to provide long-lasting beauty. Comes complete with all necessary mounting hardware.

53665-87 Chrome. **\$149.95**
Fits King, Chopped and Razor-Pak Tour-Pak® carrier lids.

C. TOUR-PAK ACCENT RAIL – CHROME

Fabricated from highly polished steel tubing, these premium quality chrome-plated Accent Rails frame the wrap-around Tour-Pak carrier's lights for a custom look. The rails provide an added level of protection from pass-by contact. Kit includes all necessary mounting hardware.

53000229 Chrome. **\$144.95**
Fits '14-later FLHTCU, FLHTCUL, FLHTK, FLHTKL, FLTRK, FLTRU, FLHTCUTG, FLTRXSE and models equipped with accessory King Tour-Pak® and LED Wrap-Around Light. Does not fit CVO™ FLHTKSE or FLTRUSE models.



B. PREMIUM TOUR-PAK LUGGAGE RACK



C. TOUR-PAK ACCENT RAIL – CHROME

D. SADDLEBAG GUARD RAILS

Bolt on style and protection. These Saddlebag Guard Rails surround and protect the lower portion of the bag, and add a traditional look to your Touring bike. The thick-walled chrome-plated tubing and the elegant cast mounts clamp securely to the Original Equipment saddlebag guards for a seamless look. Offered in Chrome or Gloss Black finish to match any bike style.

Fits '14-later Touring models (except FLHRC, FLHRSE, FLHXSE, and FLTRXSE), FLHT, FLHRXS, FLHX, FLHXS, FLHXST, FLTRX, FLTRXS and FLTRXST require separate purchase of Saddlebag Guard and Support Kit P/N 90200787 or 90200788. Does not fit with stretched side covers or CVO style rear fender system.

90201903	Chrome.	\$255.95
90201902	Gloss Black.	\$255.95



D. SADDLEBAG GUARD RAILS – CHROME



D. SADDLEBAG GUARD RAILS – GLOSS BLACK



E. TOURING SADDLEBAG LID RAILS – CHROME



F. AIR WING FENDER RAIL FOR TRIKE – CHROME



G. AIR WING SADDLEBAG LID RAIL KIT – CHROME



G. AIR WING SADDLEBAG LID RAIL KIT – GLOSS BLACK



H. AIR WING RAIL LED LIGHT KIT



TOURING & TRIKE 271

Saddlebag Lid Rails

E. TOURING SADDLEBAG LID RAILS

Protect your saddlebag lids from scratches and boot marks. Elegant welded rails are formed of high-quality tubing, and are beautifully polished and chrome plated to a mirror-like finish. The rails are shaped to wrap down the front of the saddlebag lid, and are designed to accept model-specific medallions (sold separately) for a custom touch. The three-point mount simplifies installation, and the complete kit includes left and right rails, and mounting hardware.

90200876 Chrome. **\$149.95**
Fits '14-later Touring models with Color-Matched Hard Saddlebags. Does not fit FLHXSE or models with saddlebag lid speakers or Passenger Armrest Kit P/N 52400073.

90200737 Chrome. **\$139.95**
Fits '93-'13 Touring models with Color-Matched Hard Saddlebags. Does not fit models with leather covered bags or models equipped with Saddlebag Wing Tips P/N 53826-00B or models equipped with Saddlebag Speaker Kit P/N 76000202.

F. AIR WING FENDER RAIL FOR TRIKE – CHROME

The low-profile aerodynamic shape of the Air Wing Fender Rail enhances the look and protects the surface of your Trike's rear fenders. The mirror chrome rails follow the sleek contours of the fenders, and the slim rails and die-cast rear wings complement the available Air Wing Tour-Pak® Luggage Rack. Kit includes left and right rail and all necessary mounting hardware.

61400058 Chrome. **\$180.95**
Fits '09-later FLHTCUTG, FLHTCUTGSE and '10-'11 FLHXXX models. Does not fit with Trike Fender Bra P/N 57892-11.

G. AIR WING SADDLEBAG LID RAIL KIT

The low-profile aerodynamic styling of the Air Wing Saddlebag Lid Rail enhances the look and protects the lid of your Color-Matched Hard Saddlebags. Available in mirror chrome or gloss black finish, the rails cascade down the front of the saddlebag to protect the paint from a misplaced boot heel, and the die-cast wing design at the rear complements the style of the Air Wing Luggage Rack. Kit includes all necessary mounting hardware. For added visibility, add the available Air Wing Light Kit (sold separately).

Fits '14-later Touring models with Color-Matched Hard Saddlebags. Does not fit FLHXSE or models with saddlebag lid speakers or Passenger Armrest Kit P/N 52400073.

90200792	Chrome.	\$160.95
90200793	Gloss Black.	\$160.95

Fits '93-'13 Touring models with Color-Matched Hard Saddlebags. Does not fit models with leather covered bags or models equipped with Saddlebag Wing Tips P/N 53826-00B or models equipped with Saddlebag Speaker Kit P/N 76000202.

88299-09 Chrome. **\$149.95**

H. AIR WING RAIL LED LIGHT KIT*

Custom fit to the Air Wing Rails, this fast-acting LED Light Kit operates as a supplemental rear running light and brake light. The high and outside mounting position places the lights in the line-of-sight of following vehicles, and the bright, fast-acting LED lamps get you noticed. Wiring is concealed inside the rack tubes for a clean, custom installation.

Fits '14-later Touring models equipped with Air Wing Saddlebag Rails P/N 90200792 or 90200793.

68000115	Red.	\$95.95
68000114	Smoked.	\$95.95

Fits '93-'13 Touring models equipped with the Air Wing Saddlebag Lid Rails P/N 88299-09, 90200391 and '09-'13 Trike models equipped with Air Wing Trike Fender Rails P/N 61400058.

68388-10 Red. **\$95.95**



***WARNING:** Do not use this rack as a seat. Do not exceed the fender rack weight capacity. Using as seat or exceeding this capacity could cause handling problems, which could result in loss of control and death or serious injury.



***WARNING:** Disconnecting your DOT-required tail, brake and turn signal lighting could reduce your visibility to others and result in death or serious injury.

Notice: The prices appearing in this catalog are the manufacturer's suggested retail prices. Actual retail prices may vary.

Notice: The prices appearing in this catalog are the manufacturer's suggested retail prices. Actual retail prices may vary.

TOURING

272 TOURING & TRIKE

Saddlebag Guards

A. SADDLEBAG SUPPORT KIT

Complete the stripped-down look by eliminating the rear saddlebag guards. This kit replaces the Original Equipment loop saddlebag guard and support with an inconspicuous bolt-on bar that supports the saddlebag for a clean, custom appearance. Kit includes left and right support and all necessary mounting hardware.

90200981 **\$107.95**
Fits '14-later FLH, FLHR, FLHTCU, FLHTCUL, FLHTK, FLHTKL, FLHTKSE, FLTRK, FLTRKSE and FLTRU models. Stock on '14-later FLHRSE, FLHRXS, FLHT, FLHX, FLHXS, FLHXSE, FLHXST, FLTRK, FLTRUSE, FLTRX, FLTRXS and FLTRXST models. Stock on '20-later FLTRXSE.

90881-09A **\$196.95**
Fits '09-'13 Touring models (except FLHRC and FLHTCUSE). Stock on '09-'13 FLHX, FLHXSE, FLTR, FLTRU, FLTRX, FLTRXSE, '13 FLHRSE and '09 FLTRSE models. Does not fit with Saddlebag Filler Strip Kits.

46565-04 **\$170.95**
Fits '97-'08 Touring (except FLHRC) models. Stock on FLHRS, FLHX and '04-'08 FLTR models.



A. SADDLEBAG SUPPORT KIT ('14-LATER MODELS)



A. SADDLEBAG SUPPORT KIT ('09-'13 MODELS)



B. REAR SADDLEBAG GUARD AND SUPPORT KIT – CHROME ('14-LATER MODELS)



B. REAR SADDLEBAG GUARD AND SUPPORT KIT – GLOSS BLACK '14-LATER MODELS



B. REAR SADDLEBAG GUARD AND SUPPORT KIT – CHROME '09-'13 MODELS



C. REAR SADDLEBAG GUARDS – GLOSS BLACK ('14-LATER MODELS)



C. REAR SADDLEBAG GUARDS – GLOSS BLACK ('09-'13 MODELS)



D. COMFORT PROFILE REAR SADDLEBAG GUARD KIT



TOURING & TRIKE 273

Saddlebag Guards

C. REAR SADDLEBAG GUARDS – GLOSS BLACK*

Add a sinister look to your ride. Designed to replace the Original Equipment chrome-plated guards featured on many Touring models, the blacked-out finish minimizes the look without a reduction in protection.

90200791 **\$206.95**
Fits '14-later FLHR, FLHRC, FLHTCU, FLHTCUL, FLHTK, FLHTKL, FLHTKSE, FLTRK, FLTRU and '20-later FLTRK and FLTRKSE models. Installation requires reuse of Original Equipment saddlebag supports.

49283-09 **\$213.95**
Fits '09-'13 Touring models. FLHX, FLTR, FLTRU, FLTRX, FLTRXSE, '13 FLHRSE, '10-'12 FLHXSE and '09 FLTRSE models require separate purchase of Saddlebag Supports P/N 49194-09A and 90781-09A, Nut P/N 7531 (Qty 2) and Antenna Mounting Bracket P/N 76516-09.

46548-03 **\$213.95**
Fits '97-'08 Touring models. ('04-'08 FLTR, FLHX and FLHRS models require the separate purchase of Saddlebag Supports P/N 49194-85 and 90781-93 and two P/N 3601 and 7686.)

D. COMFORT PROFILE REAR SADDLEBAG GUARD KIT*

The unique profile of these chrome-plated Rear Saddlebag Guards gives your passenger more leg room. A perfect replacement for the Original Equipment saddlebag guards.

49179-09 **\$213.95**
Fits '09-'13 Touring models (except FLHTC, FLHTCU and FLHTCUSE), '09-'13 FLHX, FLHXSE, FLTR, FLTRU, FLTRX and FLTRXSE, '13 FLHRSE and '09 FLTRSE models require separate purchase of Saddlebag Supports P/N 49194-09A and 90781-09A, Nut P/N 7531 (Qty 2) and Antenna Mounting Bracket P/N 76516-09. FLHRC models require separate purchase of reflectors P/N 59370-98 and 59371-98.

49087-01 **\$213.95**
Fits '97-'08 FLHR, FLTR, FLHX and FLHT models. FLHRCI models require separate purchase of Reflector P/N 59370-98 and 59371-98. '04-'08 FLTR, FLHX and FLHRS models require separate purchase of Saddlebag Supports P/N 49194-85 and 90781-93 and two each of P/N 3601 and 7686. (Will not fit Saddlebag Guard Bags.)



***WARNING:** These guards may provide limited leg and cosmetic vehicle protection under unique circumstances (fall over while stopped, very low speed slide). They are not made nor intended to provide protection from bodily injury in a collision with another vehicle or any other object.



***WARNING:** These guards may provide limited leg and cosmetic vehicle protection under unique circumstances (fall over while stopped, very low speed slide). They are not made nor intended to provide protection from bodily injury in a collision with another vehicle or any other object.

Notice: The prices appearing in this catalog are the manufacturer's suggested retail prices. Actual retail prices may vary.

Notice: The prices appearing in this catalog are the manufacturer's suggested retail prices. Actual retail prices may vary.

274 TOURING & TRIKE

Luggage Accessories

A. PREMIUM TOUR-PAK® LUGGAGE FITTED LINING

Line your Touring bike's luggage to protect your belongings and reduce noise and rattles on the road. Soft-touch felt-finish liner is formed to the interior for a perfect fit. Molded base and sides maximize the interior room, and one-piece design allows easy removal for cleaning and maintenance.

53000323 King Tour-Pak® luggage. **\$98.95**
Fits '14-later Touring and Tri Glide® models equipped with King Tour-Pak luggage.

53301-06 King Ultra Tour-Pak luggage. **\$98.95**
Fits '93-'13 Touring (except FLHTK and '10-later CVO™ models) and Trike models equipped with King Tour-Pak luggage with incandescent wrap-around Tail Lamp Kit. Does not fit with Tour-Pak bottom tub mounted accessories.

53302-07 King Classic Tour-Pak luggage. **\$98.95**
Fits '93-'13 Touring and Trike models equipped with King Tour-Pak luggage without incandescent wrap-around Tail Lamp Kit. Does not fit with Tour-Pak bottom tub mounted accessories.

53000322 Chopped Tour-Pak luggage. **\$87.95**
Fits '14-later Touring and Tri Glide models equipped with Chopped Tour-Pak luggage. Does not fit with Tour-Pak bottom tub mounted accessories. Does not fit Tri-Glide models or models with Original Equipment King Tour-Paks.

B. PREMIUM FITTED SADDLEBAG LINING

Protect your belongings and reduce noise and rattles on the road. Premium soft-touch felt-finish liner is formed to the hard saddlebag interior for a perfect fit. Molded base and sides maximize the interior room, and one-piece design allows easy removal for cleaning and maintenance.

90200918 **\$207.95**
Fits '14-later Touring models equipped with Color-Matched Hard Saddlebags (except FLHTKSE, FLHXSE, FLTRKSE and FLTRXSE).

92189-06 **\$175.95**
Fits '93-'13 Touring models equipped with Original Equipment Color-Matched Hard Saddlebags. Does not fit Police model saddlebags.



A. PREMIUM TOUR-PAK LUGGAGE FITTED LINING – KING ULTRA '93-'13 MODELS



A. PREMIUM TOUR-PAK LUGGAGE FITTED LINING – KING ULTRA '93-'13 MODELS



A. PREMIUM TOUR-PAK LUGGAGE FITTED LINING – KING '14-LATER MODELS



A. PREMIUM TOUR-PAK LUGGAGE FITTED LINING – CHOPPED '14-LATER MODELS



B. PREMIUM FITTED SADDLEBAG LINING – '14-LATER MODELS



B. PREMIUM FITTED SADDLEBAG LINING – '93-'13 MODELS



C. TOUR-PAK LID FITTED LINING WITH ORGANIZER – PREMIUM BLACK



D. TOUR-PAK LID ORGANIZER/LINER – GRAY



E. TOUR-PAK LID ORGANIZER – TOUR-PAK



F. TRUNK DOOR ORGANIZER



TOURING & TRIKE 275

Luggage Accessories

C. TOUR-PAK® LID FITTED LINING WITH ORGANIZER – PREMIUM BLACK

Equip the Tour-Pak® lid to protect and store your belongings. This Premium Lid Lining features a soft-touch black felt finish to reduce noise, and a convenient series of storage pouches that provide easy access to all your essentials. Four flap pouches and one mesh and one clear pocket provide plenty of storage and a great way to keep keys, cell phones, glasses and papers handy. Hook-and-loop fasteners secure the one-piece formed lining to the lid, and allow easy removal for cleaning and maintenance.

53000392 **\$175.95**
Fits '14-later Touring and Tri Glide® models equipped with King or Chopped Tour-Pak luggage.

D. TOUR-PAK LID FITTED LINING WITH ORGANIZER – GRAY

Add practical storage to your Tour-Pak luggage. This Lid Lining features a convenient six pocket organizer to keep smaller items conveniently at hand, and is shaped to fit the contours of the Tour-Pak lid for a finished look. The organizer features four enclosed pouches, one mesh pouch and one clear mobile-device pouch. The soft gray finish is the perfect match for the Original Equipment Tour-Pak bottom liner, and the hook-and-loop fasteners permit easy removal for cleaning.

53000302 **\$175.95**
Fits '14-later Touring and Tri Glide models equipped with King or Chopped Tour-Pak luggage.

E. TOUR-PAK LID ORGANIZER

A true innovation in storage convenience and efficiency, this ingenious lid organizer helps keep smaller items conveniently located under your Tour-Pak lid for easy access. The organizer features five different-sized nylon-meshed pockets, as well as two flaps for additional storage. A great way to keep keys, cell phones, glasses and papers handy.

53249-01B **\$103.95**
Fits '93-'13 Touring and Trike models equipped with a King, Ultra, Chopped or Razor-Pak Tour-Pak. Does not fit '08-later CVO™ Ultra models with Power Locks, or models equipped with Tour-Pak Spoiler Kit P/N 53149-series, Tour-Pak Light P/N 54302-98A, Mini Tour-Pak Lid Rack P/N 53100-96 or Contoured Tour-Pak Luggage Rack P/N 79148-06A.

F. TRUNK DOOR ORGANIZER

For on-the-road storage and efficiency, this ingenious organizer helps keep smaller items conveniently located on your trunk door for easy access. The easy-to-install self-adhesive organizer features two large nylon-mesh pockets with hook-and-loop-secured flaps that offer quick access to keys, cell phones, glasses, gloves and maps. Organizer features an embossed Harley-Davidson script logo. Add the matching Tour-Pak Lid Organizer P/N 53249-01B inside the Tour-Pak luggage for maximum organization.

93300001 **\$71.95**
Fits '09-later FLHTCUTG and '10-'11 FLHXXX models.

Notice: The prices appearing in this catalog are the manufacturer's suggested retail prices. Actual retail prices may vary.

Notice: The prices appearing in this catalog are the manufacturer's suggested retail prices. Actual retail prices may vary.

276 TOURING & TRIKE

Luggage Accessories

A. TOUR-PAK® WALL ORGANIZER

Convenient storage system wraps the interior walls of your King Tour-Pak® luggage for easy access to keys, cell phones, maps and gloves. The organizer features a variety of mesh and enclosed pockets, sized perfectly to keep small items close at hand. Easily installed with included hook-and-loop tabs.

53000303 **\$117.95**

Fits '14-later Touring and Tri Glide® models (except CVO™ models) equipped with King Tour-Pak Luggage.

54014-05 **\$98.95**

Fits '93-'13 Touring and Trike models equipped with Ultra or King Tour-Pak luggage. Does not fit with Chopped or Razor-Pak Tour-Pak.



A. TOUR-PAK WALL ORGANIZER – '14-LATER MODELS



A. TOUR-PAK WALL ORGANIZER – '93-'13 MODELS



C. TRIKE SADDLEBAGS

Add storage at your fingertips. These vinyl-wrapped rigid side bags are a perfect match to either the Original Equipment or accessory seats and are contoured to fit comfortably under the passenger's legs. Featuring an easy-to-grip chrome-plated finger pull with Bar & Shield Logo, the forward-opening bags snap shut with a strong magnetic closure. The interior can accommodate 2 soda cans or water bottles side by side and is the ideal spot for sunscreen, glasses and your cell phone. Luggage capacity: 700 cubic inches total.

84031-11 **\$476.95**

Fits '09-later FLHTCUTG and '10-'11 FLHXXX models.



B. SADDLEBAG WALL ORGANIZER – ('14-LATER MODELS SHOWN)



C. TRIKE SADDLEBAGS



D. PREMIUM TRAVEL-PAK – KING TOUR-PAK



D. PREMIUM TRAVEL-PAK – HARD SADDLEBAGS



E. TRAVEL-PAK – KING TOUR-PAK



E. TRAVEL-PAK – HARD SADDLEBAGS



E. TRAVEL-PAK – LEATHER SADDLEBAGS



F. SADDLEBAG COOLER



TOURING & TRIKE 277

Luggage Accessories

D. PREMIUM TRAVEL-PAKS

This collection of fitted luggage provides convenient storage for your next long ride. The bags are manufactured of water resistant ballistic nylon that matches the premium luggage collection. The exterior features comfortable carrying handles, heavy-duty glove-friendly zippers, a zippered pocket, D-rings for optional carrying straps. The padded interior features a variety of convenient storage pockets and plenty of open storage. Saddlebag right-hand bag features an internal padded laptop pocket and plenty of smart storage spaces.

93300072 King Tour-Pak® luggage. **\$110.95**

Fits '93-later Touring and Trike models equipped with King Tour-Pak luggage.

93300070 Hard Saddlebags. **\$143.95**

Fits '93-later Touring models equipped with Hard Saddlebags. Sold in pairs.

E. TRAVEL-PAKS

Simplify packing and unpacking your motorcycle. These well-constructed, water-resistant bags are designed to fit perfectly into Touring model luggage systems. The soft sides conform to the interior of the luggage to help use every available inch of space. Styled with a Bar & Shield logo, they feature heavy-duty zippers and convenient carrying handles.

53605-97 King Tour-Pak luggage. **\$71.95**

Fits '93-later Touring and Trike models equipped with King and Ultra Tour-Pak luggage.

91885-97A Hard Saddlebags. **\$76.95**

Fits '93-later Touring models equipped with Color-Matched Hard Saddlebags and '09-'17 VRSCF models equipped with Rigid Saddlebags P/N 91172-09. Sold in pairs.

91887-98 Leather Saddlebags. **\$71.95**

Fits '98-later FLHRC and FLHRS models. Sold in pairs.

F. SADDLEBAG COOLER

Keep beverages and snacks cold right in your saddlebag on those hot summer rides. This zippered bag is fully lined and insulated, and fits the full length of your saddlebag.

90200991 **\$82.95**

Fits '93-later Touring models equipped with Color-Matched Hard Saddlebags.

Notice: The prices appearing in this catalog are the manufacturer's suggested retail prices. Actual retail prices may vary.

Notice: The prices appearing in this catalog are the manufacturer's suggested retail prices. Actual retail prices may vary.

278 TOURING & TRIKE

Luggage Accessories

A. TRUNK TRAVEL-PAKS

These well-constructed, ballistic nylon bags are designed to fit perfectly into the rear or top-load trunk of the Harley-Davidson® Trike models. Styled to compliment the Premium Luggage Collection, the twin bags feature white piping and a reflective Bar & Shield logo. The bags feature glove-friendly zippered access to the main compartment and convenient outer pouches. Comfortable carrying straps make transportation a breeze. Sold in pairs.

53000431 **\$126.95**
Fits '09-later Trike models.



A. TRUNK TRAVEL-PAKS



A. TRUNK TRAVEL-PAKS

B. SADDLEBAG GUARD BAG WITH WATER BOTTLE HOLDER – BAR & SHIELD LOGO

Convenient on-the-go storage. Sturdy synthetic leather bags snap to the saddlebag guards for easy access. The storage compartment features a hook-and-loop outer flap and a zippered inner closure to store sunglasses, wallets and cell phones, and the adjoining sleeve securely grips a removable water bottle to help keep you hydrated on the road.

Fits '93-later Touring models equipped with Saddlebag Guards.

93300060 Right Side. **\$87.95**
93300061 Left Side. **\$87.95**

C. SADDLEBAG GUARD BAG – BAR & SHIELD LOGO

Keep your essentials close at hand. Bags are constructed of sturdy synthetic leather, with hook-and-loop flap covers and a dual zippered opening that provides easy access to the interior. A separate internal zippered soft pouch is perfect for storing smaller items or sunglasses. Synthetic leather bags snap tightly to the saddlebag guard.

Fits '93-later Touring models equipped with Saddlebag Guards.

93300062 Right Side. **\$87.95**
93300063 Left Side. **\$87.95**



A. TRUNK TRAVEL-PAKS



B. SADDLEBAG GUARD BAG WITH WATER BOTTLE HOLDER – BAR & SHIELD LOGO



C. SADDLEBAG GUARD BAG – BAR & SHIELD LOGO



D. SADDLEBAG LID BRA (90200992 SHOWN)



D. SADDLEBAG LID BRA (57805-03A SHOWN)



E. TANK BRA



F. TRIKE REAR FENDER BRA



G. TRIKE SCUFF GUARDS – BODY & FENDER



G. TRIKE SCUFF GUARDS – FENDER



G. TRIKE SCUFF GUARDS – BODY

TOURING & TRIKE 279

Luggage Accessories

D. SADDLEBAG LID BRA

Protect your saddlebags from boot scuffs, stone chips and road debris. These custom-fit Saddlebag Lid Bras are made with non-abrasive, fleece-backed vinyl material and feature small Bar & Shield logos. Easy to install with hook-and-loop tabs. Kit includes left and right side Lid Bras.

90200992 **\$107.95**
Fits '14-later Touring models with Color-Matched Hard Saddlebags. Does not fit with Saddlebag Lid Rails, Saddlebag Lid Spoilers or Saddlebag Lid Speakers.

57805-03A **\$107.95**
Fits '93-'13 Touring models equipped with Color-Matched Hard Saddlebags. Does not fit with Police Model Hard Saddlebags, Saddlebag Lid Rails, Saddlebag Lid Spoilers, or Saddlebag Wing Tips.

E. TANK BRA

Manufactured from non-abrasive, fleece-backed vinyl, this Tank Bra for your Touring model features an embroidered Bar & Shield logo. It protects your fuel tank from belt buckle and key scratches and nicks from road debris. Designed for easy installation and a custom fit without tank or seat removal.

62063-01 **\$48.95**
Fits '97-later Touring and Trike models.

F. TRIKE REAR FENDER BRA

Protect your Trike's rear fenders from boot scuffs and road debris. These rich black Fender Bras are constructed of non-abrasive fleece-backed smooth vinyl, and are simple to install. Featuring a prominent embossed Bar & Shield logo, these Bras are styled to coordinate with the matching Fairing Bra P/N 57800-00.

57892-11 **\$107.95**
Fits '09-later FLHTCUTG and '10-'11 FLHXXX models. Not for use with Chrome Fender Trim Kit P/N 83812-09. Does not fit '17-later Canada FLHTCUTG.

G. TRIKE SCUFF GUARDS

Guard against heel marks and stone chips on the leading edges of the rear fender and body of your Trike model. These heavy-duty molded rubber pads are shaped to match the contour of the body, and are easy to install with the pre-applied adhesive. The ribbed surface pattern mirrors the Original Equipment footboard inserts, and offers a clean, smooth-flowing look between the footboards and body.

Fits '09-later FLHTCUTG and '10-'11 FLHXXX models.
83968-10 Body Scuff Guards. **\$33.95**
83976-10 Fender Scuff Guards. **\$43.95**

Notice: The prices appearing in this catalog are the manufacturer's suggested retail prices. Actual retail prices may vary.

Notice: The prices appearing in this catalog are the manufacturer's suggested retail prices. Actual retail prices may vary.

280 TOURING & TRIKE

Foot Controls

A. EXTENDED REACH RIDER FOOTBOARD PANS

This kit extends the rider footboard forward of the stock location by 1", providing the tall rider a comfortable riding position. When paired with Extended Reach Brake and Shift Levers, these pans allow riders with large boot sizes ample room to reposition their feet during a long ride. Available in traditional D-shape or Swept Wing design. Extended Reach footboard pans accept Original Equipment or accessory rider footboard inserts. The kit includes left and right footboard pans.

Fits '02-later Touring (except FLHTCUL and FLHTKL) and Trike models. Also fits '97-'01 Touring models equipped with Extended Reach Billet Style Brake Lever P/N 42638-03.

54145-10 Swept Wing. **\$95.95**

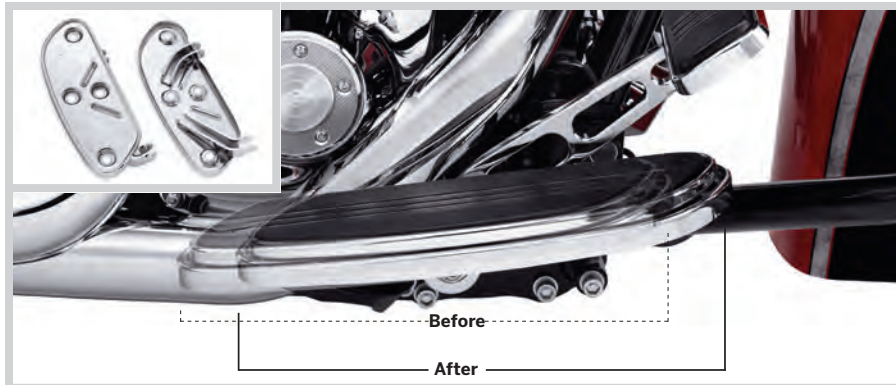

A. EXTENDED REACH RIDER FOOTBOARD PANS – SWEEP WING SHAPE

B. BLACK RIDER FOOTBOARD PANS

Complete the blacked-out transformation. Replace the Original Equipment chrome footboard pans with sinister gloss black. Kit includes both the right and left pan, and is installed using the Original Equipment hardware and insert pad. Custom footboard inserts are sold separately.

Fits '12-'16 FLD and '86-'17 FL Softail® (except FLS, FLSS, FLSTFB and FLSTFBS), '86-later Touring (except FLHTCUL, FLHTCUL TC and FLHTKL) and Trike models.

51322-08 Traditional Shape. **\$107.95**

51060-08 Swept Wing Shape. **\$107.95**



B. BLACK RIDER FOOTBOARD PANS – TRADITIONAL SHAPE



B. BLACK RIDER FOOTBOARD PANS – SWEEP WING SHAPE

C. JIFFY STAND EXTENSION

Jiffy Stand Extension Kits have been ergonomically designed to simplify the deployment and retraction of the jiffy stand. The extension is shaped to simplify locating the tab with your boot, and aid in swinging the jiffy stand into position. The move feels natural, and adds confidence when parking your motorcycle in a tight spot. Kit mounts to Original Equipment jiffy stand, and includes all required mounting hardware.

Fits '91-later Touring models. Does not fit models equipped with Defiance footboards, Burst footboards, or Rider Running Boards P/N 50500158.

50000263 Gloss Black. **\$43.95**

50000023 Chrome. **\$43.95**



C. JIFFY STAND EXTENSION – CHROME



C. JIFFY STAND EXTENSION – GLOSS BLACK

D. JIFFY STAND AND MOUNT KIT – GLOSS BLACK

With this beautiful gloss black jiffy stand kit, your Dark Custom Touring model won't just stand on its own – it will stand out. Using the Original Equipment jiffy stand and mount to ensure quality and fitment, these pieces are finished in rich gloss black to blend into the frame and help disguise this very visual component on the vehicle. Installation reuses Original Equipment spring and hardware.

50000276 **\$240.95**

Fits '17-later Touring Models.

50000122 **\$240.95**

Fits '09-'16 Touring models (except FLHTCUL and FLHTKL).



D. JIFFY STAND AND MOUNT KIT – GLOSS BLACK

E. RIDER FOOTBOARD HEEL GUARD

Avoid damaged boots and hours of cleaning melted rubber scuff marks from your exhaust shield. This Heel Guard mounts to the right-side rider footboard and protects your boot from contact with the hot exhaust shield. The subtle curved shape keeps the boot heel away without restricting fore-and-aft movement of the rider's foot. Kit includes chrome guard with cutaway Bar & Shield logo and all mounting hardware.

50500225 **\$74.95**

Fits '12-'16 FLD, '86-'17 FL Softail, '86-later Touring and '09-later Trike models equipped with Traditional and Swept Wing footboards. Does not fit models equipped with Half-Moon, Tapered, Airflow, Defiance, Dominion™ or Burst footboards, Extended Reach Rider Footboards P/N 50409-04 or 54145-10, Rider Running Boards P/N 50500158 or Screamin' Eagle® Fat Exhaust Shields.



E. RIDER FOOTBOARD HEEL GUARD



F. FOLDING HEEL SHIFTER – RETRACTED POSITION



G. HEEL/TOE SHIFTER SHAFT COVER



H. SHIFTER SHAFT LEVER – GLOSS BLACK



I. CUSTOM GEAR SHIFT LINKAGE – ROUND GLOSS BLACK



J. CUSTOM GEAR SHIFT LINKAGES



K. GEAR SHIFT LINKAGE COVERS

TOURING & TRIKE 281

Foot Controls

F. FOLDING HEEL SHIFTER

Give your left foot a little extra room. The Folding Heel Shifter permits the rider to move the rear shift peg out of the way when on the open road, while retaining heel/toe shift functionality around town. Positive detent holds the peg in the selected position, and can be adjusted while riding. Easy to install, the replacement rear lever is chrome-plated, and shaped to match the Original Equipment toe shift lever. Lever accepts stock or accessory shifter peg.

33876-07 **\$89.95**
Fits '86-'17 FL Softail®, '88-'16 Touring and '08-'16 Trike models.

G. HEEL/TOE SHIFTER SHAFT COVER

Conceal the splined end of the shifter shaft when you remove the heel shift lever. The easy-to-install chrome-plated aluminum billet cap is held in place with a flush Allen® screw for a clean look.

35471-05 **\$22.95**
Fits '82-'17 FL Softail, and '82-later Touring and Trike models equipped with heel/toe shift levers. Installation requires removal of heel shift lever.

H. SHIFTER SHAFT LEVER – GLOSS BLACK

The perfect companion to black or edge-cut heel and toe shift levers and shift linkages, this Gloss Black Shifter Shaft Lever creates an uninterrupted blacked-out look from the front of the engine to the rear. Manufactured from Original Equipment components, this lever is an exact replacement for the factory-installed chrome-plated part.

33900186 **\$43.95**
Fits '93-'16 Touring and Trike models.

I. CUSTOM GEAR SHIFT LINKAGE – ROUND GLOSS BLACK

Add the finishing touch to your blacked-out ride. This Gloss Black Shift Linkage is easy to install and includes a transmission lever cover and decorative acorn nuts and bolts for a complete custom look.

33600259 **\$111.95**

Fits '86-later Softail (except '18-later FXBB, FXBBS, FXLR, FXLRS, FXLRST and '20-later FXST), Touring and Trike models. (Does not fit '97-'99 FLSTS or models equipped with Softail Extended Reach Forward Controls.)

J. CUSTOM GEAR SHIFT LINKAGES

Kick your custom into gear with this collection of high-quality Custom Shift Linkages. Available in a variety of designs to match your bike's style, these aluminum linkages feature aircraft-quality rod ends for easy adjustment and smooth operation. The easy-to-install linkage kit also includes a transmission lever cover for '86-'17 Softail and '86-'16 Touring and Trike models, and decorative acorn nuts and bolts for a complete custom look.

Fits '86-later Softail (except '18-later FXBB, FXBBS, FXLR, FXLRS and FXLRST and '20-later FXST), Touring and Trike models. (Does not fit '97-'99 FLSTS or models equipped with Softail Extended Reach Forward Controls.)

1. 34018-08 Slotted – Black Anodized. **\$142.95**

2. 34850-09 Skull. **\$139.95**

3. 33801-09 Harley-Davidson Script. **\$139.95**

4. 33760-09 Slotted with Bar & Shield Logo. **\$142.95**

5. 33814-98A Round. **\$99.95**

K. GEAR SHIFT LINKAGE COVERS

A simple and inexpensive way to detail your Touring bike. These easy-to-install chrome-plated covers conceal the stock gear shifter linkage for a brilliant finish. Kit includes all necessary mounting hardware.

Fits '99-'16 Touring and Trike models with stock gear shift linkage.

1. 46303-01 Harley-Davidson Script. **\$50.95**

2. 46305-01 Engraved Harley-Davidson. **\$50.95**

282 TOURING & TRIKE

Foot Controls

A. BOARD-TO-PEG CONVERSION KIT

Add an aggressive look to your Touring motorcycle. These support kits are designed to allow installation of mini footboards and footpegs. Kit Includes left and right mounting brackets and all necessary installation hardware. Mini footboards and footpegs sold separately.

Fits '09-later Touring models (except '18-later FLTRXSE). Requires separate purchase of '18-later Original Equipment or accessory Softail® Standard rider footpegs.

50501642 **\$213.95**

B. ENDGAME COLLECTION BRAKE LEVER

Styled to complement the Endgame Collection controls, this Rear Brake Lever features a slotted design that will give your bike an industrial look.

Fits '14-later Touring and Trike models.

41600305 Black. **\$194.95**

41600304 Graphite. **\$221.95**

C. BILLET STYLE REAR BRAKE LEVER

Styled to complement our billet style mirror stems and shift levers, these Billet Style Rear Brake Levers are forged from billet aluminum, then machined and polished for a beautiful, custom look. Available in your choice of finishes. Lever matches the length of the Original Equipment brake lever. Brake pedal pads sold separately.

Fits '14-later Touring and Trike models.

41600082 Chrome. **\$216.95**

41600079 Edge Cut. **\$221.95**

D. AIRFLOW COLLECTION REAR BRAKE LEVER

Forged from billet aluminum, this brake lever makes its own custom statement. Featuring a deep groove that runs the length of the arm, the swept shape of the lever adds a strong visual element to the bike's profile. Designed to match the Airflow collection, this lever complements your contemporary or classic styling direction. Airflow lever matches the Original Equipment length to maintain the factory riding position. Brake pedal pads sold separately.

41600280 Gloss Black. **\$189.95**

Fits '14-later Touring and Trike models.



A. BOARD-TO-PEG CONVERSION KIT



A. BOARD-TO-PEG CONVERSION KIT



E. ENDGAME COLLECTION SHIFT LEVER – BLACK



E. ENDGAME COLLECTION SHIFT LEVER – GRAPHITE



B. ENDGAME COLLECTION BRAKE LEVER – BLACK



B. ENDGAME COLLECTION BRAKE LEVER – GRAPHITE



F. BILLET STYLE HEEL/TOE SHIFT LEVER – EXTENDED REACH



G. BILLET STYLE HEEL/TOE SHIFT LEVER – STANDARD LENGTH, CHROME



C. BILLET STYLE REAR BRAKE LEVER – CHROME



C. BILLET STYLE REAR BRAKE LEVER – EDGE CUT



G. BILLET STYLE HEEL/TOE SHIFT LEVER – STANDARD LENGTH, EDGE CUT



G. BILLET STYLE HEEL/TOE SHIFT LEVER – STANDARD LENGTH, SATIN BLACK



D. AIRFLOW COLLECTION REAR BRAKE LEVER



H. AIRFLOW COLLECTION HEEL/TOE SHIFT LEVER



I. HEEL SHIFTER

TOURING & TRIKE 283

Foot Controls

E. ENDGAME COLLECTION SHIFT LEVER

Styled to complement the Endgame Collection controls, this Shift Lever features a slotted design that will give your bike a high-tech, industrial look.

Fits '86-later FL Softail®, '88-later Touring and '08-later Trike models.

33600301 Black. **\$111.95**

33600292 Graphite. **\$111.95**

F. BILLET STYLE HEEL/TOE SHIFT LEVER – EXTENDED REACH

Stretch out in style. Both the heel and toe sections of this Shift Lever are 1.0" longer than traditional levers, separating the distance between the heel/toe shift by 2.0" total. This added space provides a comfortable riding position for a tall rider, and allows a rider with a large boot extra room to move. Styled to complement our billet style mirror stems, these Billet Style Shift Levers are forged, machined and polished for a beautiful, custom look. When combined with the available Extended Reach Brake Lever, long-limbed riders can straighten their legs and ride in comfort. Kit includes a front and rear lever and mounting hardware.

33600001 Chrome. **\$178.95**

Fits '86-'17 FL Softail®, '88-later Touring and '08-later Trike models.

G. BILLET STYLE HEEL/TOE SHIFT LEVER – STANDARD LENGTH

Styled to complement our billet style mirror stems, these Billet Style Shift Levers are forged from 7075-T6 aluminum, then machined and polished for a beautiful, custom look. Available in your choice of mirror chrome, satin black powder coat or edge cut black anodized and machined aluminum finishes. Kit includes a front and rear lever and chrome hardware.

Fits '86-'17 FL Softail, '88-later Touring and '08-later Trike models.

34535-00B Chrome. **\$178.95**

34045-10 Edge Cut. **\$178.95**

34023-08 Satin Black. **\$178.95**

H. AIRFLOW COLLECTION HEEL/TOE SHIFT LEVER

Styled to complement the Airflow Collection, this forged billet aluminum shift lever adds a custom touch to your bike. The lever features a deep groove that catches light and draws your eye. The separate front and rear levers can be easily adjusted for convenient shifting, and the extended-length rear lever provides additional space for larger boots. Kit includes a front and rear lever and mounting hardware. Lever accepts stock or accessory shifter pegs.

33600076 Chrome. **\$173.95**

Fits '86-'17 FL Softail, '88-later Touring and '08-later Trike models.

I. HEEL SHIFTER

Add the convenience of a heel shifter to your footboard-equipped Touring model. This traditional motorcycle Heel Shifter Lever permits you to upshift with a downward tap of your boot heel – eliminating the need to wedge your toe under the forward lever and reducing wear on the top of your boot. Kit includes the chrome plated heel shift lever, extended shifter shaft, shifter peg and mounting hardware.

Fits '01-later Touring and Trike models. Stock on '84-'19 Touring and Trike. Stock on '20-later CVO™ models only..

33600345 Gloss Black. **\$54.95**

33600325 Chrome. **\$54.95**

284 TOURING & TRIKE

Foot Controls

A. PASSENGER MINI FOOTBOARD MOUNT KIT

This mount kit permits replacement of the Original Equipment passenger footboards with footpegs or mini footboards, and moves the passenger's foot rearward and inward to give the rider more space between the rider footboard and the passenger foot support. The new position clears the path for your feet to ease walking the bike in and out of parking spaces. When folded, the pegs are tighter to the bike to reduce the chance of contacting the passenger foot support with your calf. Original equipment on FLHTCUL and FLHTKL model. Kit includes left and right mount, and required installation hardware. Male-mount style passenger footpegs or mini-footboards sold separately.

50500403A **\$107.95**
Fits '93-later Touring models. Does not fit Trike models.



A. PASSENGER MINI FOOTBOARD MOUNT KIT



B. PASSENGER FOOTPEG MOUNT – GLOSS BLACK

Manufactured from Original Equipment components for proper fit and proven strength, these footpeg supports replace the factory chrome-finished mounts for a clean, custom look. When installed with blacked-out accessory footpegs, these gloss black footpeg supports tie the pegs to the bike for a seamless, no-contrast look. Kit includes right and left hand mount.

50500578 **\$160.95**
Fits '93-later Touring models. Does not fit Trike models.



B. PASSENGER FOOTPEG MOUNT – GLOSS BLACK



C. PASSENGER FOOTPEG MOUNT KIT – CHROME

Designed specifically for the sport-touring rider, this chrome-plated kit allows passenger footboards to be removed and replaced with a variety of male mount-style Harley-Davidson® footpegs. The kit has 3 adjustable height positions and includes all hardware.

50198-97C **\$147.95**
Fits '93-later Touring models. Does not fit Trike models.



C. PASSENGER FOOTPEG MOUNT KIT – CHROME

D. ADJUSTABLE PASSENGER FOOTPEG MOUNT KIT

Maximize your passenger's riding comfort. Proper foot position reduces the cramped or stretched-out feeling, and relieves pressure on the knees and the tailbone. These adjustable mounts raise and lower the passenger footpeg to accommodate taller and shorter passengers. Easy to adjust with common tools, the mount adjusts through a 360° range (depending on model), allowing both fore and aft and up and down height adjustment. Kit includes left and right adjustable support assembly and all required mounting hardware. Footpegs sold separately.

50763-09 **\$160.95**
Fits models with H-D® male mount-style passenger footpeg supports (except Softail® models). Does not fit with Heel Raiser Footpeg Kit P/N 50178-09. Does not fit the rider position.



D. ADJUSTABLE PASSENGER FOOTPEG MOUNT KIT

E. PASSENGER FOOTBOARD SUPPORTS

Add the comfort and convenience of passenger footboards to your Touring motorcycle. These supports are designed to allow installation of traditional D-shaped, Swept Wing, Tapered or Old-Style Passenger Footboards (sold separately) on Touring models. Kit includes left and right supports and installation hardware. Add your choice of passenger footboard pan design and footboard insert to complete your custom look.

Fits '93-later Touring and Trike models.
50500042 Black. **\$118.95**
53070-00A Chrome. **\$158.95**



E. PASSENGER FOOTBOARD SUPPORTS – BLACK



E. PASSENGER FOOTBOARD SUPPORTS – CHROME



F. ADJUSTABLE AUXILIARY PASSENGER FOOTPEG MOUNTS – FORWARD & MID POSITION



F. ADJUSTABLE AUXILIARY PASSENGER FOOTPEG MOUNTS – REAR POSITION



G. ADJUSTABLE PASSENGER FOOTBOARD MOUNT KIT

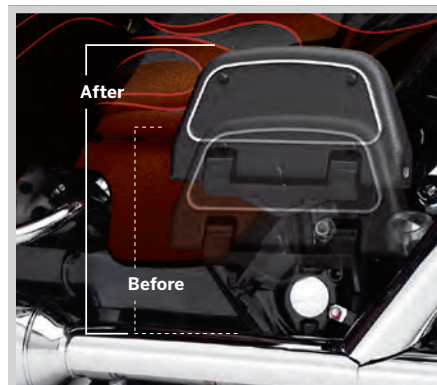

H. REACH PASSENGER FOOTBOARD MOUNT KIT



TOURING & TRIKE 285

Foot Controls

F. ADJUSTABLE AUXILIARY PASSENGER FOOTPEG MOUNTS

These 3-position adjustable passenger footpeg mounts will keep your companion happy over the long haul. Push-button adjustment lets the passenger reposition their feet to keep blood flowing in all the lower extremities. When combined with the standard footboard, both short- and long-limbed passengers should be able to find a comfortable riding position. Pegs can also be pivoted fully rearward to allow the rider the room to get his or her feet on the ground when walking the bike in and out of parking spaces. Kit includes beautifully chromed left- and right-side adjustable mounts and all installation hardware. Complete the custom look with your choice of footpegs (sold separately).

54157-10 **\$288.95**

Fits '10-later Touring models with Original Equipment passenger footboards (except CVO™ models or models equipped with Adjustable Passenger Footboard Mount Kit P/N 50768-07A). Also fits '93-later Touring models equipped with Passenger Footboard Kit P/N 50378-07B, 50379-07B or 53070-00A. Does not fit Trike models or models equipped with sidecars. Will not fit with Footpeg P/N 49117-77TB, 49110-98, 91821-85, 50643-82, 50647-82, 49500-92T, 49234-98, 50978-99, 50976-99, 50911-08, 50113-10, 50695-08, 49128-82, 50056-10, 50039-10, 49312-10, 50451-09 and 50178-09.

G. ADJUSTABLE PASSENGER FOOTBOARD MOUNT KIT

Maximize your passenger's riding comfort. These chrome 5-position adjustable mounts raise and lower the passenger footboard. The lowest position is 2.0" forward from stock, and the highest position is 2.5" higher than stock. Easy to adjust with a common hex wrench. Kit includes left and right adjustable support assembly and all required mounting hardware. Footboard pans and inserts sold separately.

50768-07A **\$409.95**
Fits '93-later Touring models. Does not fit Trike models.

H. REACH PASSENGER FOOTBOARD MOUNT KIT

Kit raises the height of your passenger footboards by approximately 2.25" for increased passenger comfort. Especially desirable on '97-later Touring models due to the frame and saddlebag guard change. Includes mounting hardware.

50789-99B **\$139.95**
Fits '93-later Touring models. Does not fit Trike models. Does not fit with saddlebag guard bags.

Notice: The prices appearing in this catalog are the manufacturer's suggested retail prices. Actual retail prices may vary.

Notice: The prices appearing in this catalog are the manufacturer's suggested retail prices. Actual retail prices may vary.

286 TOURING & TRIKE

Foot Controls

A. PASSENGER FOOTBOARD AND MOUNT KIT

Convenient bolt-on installation. Includes specially designed mounting stud/brackets for proper installation. Footboards fold up when not in use. Kit includes Original Equipment-style aluminum footboards, rubber pads, mounting hardware and passenger footboard supports.

50379-07B **\$160.95**
Fits '93-later Touring and Trike models.



A. PASSENGER FOOTBOARD AND MOUNT KIT

B. STREAMLINER PASSENGER FOOTBOARD AND MOUNT KIT

Styled to match the rider footboards on the Road King® Custom, Road Glide® Custom and Street Glide® models, these Swept Wing Passenger Footboards feature a Streamliner-style rubber pad surrounded by a chrome accent. The smooth Swept Wing footboard pan is chrome-plated throughout to add a custom touch, even in the folded position. Designed for convenient bolt-on installation, the complete kit includes chrome-plated aluminum footboards, rubber pads, mounting hardware and passenger footboard supports.

50378-07B **\$442.95**
Fits '93-later Touring models. Does not fit Trike models.



B. STREAMLINER PASSENGER FOOTBOARD AND MOUNT KIT

C. PASSENGER FOOTBOARD PANS – CHROME

Replace the factory black painted passenger footboard with the custom look of smooth chrome. These chrome-plated Footboard Pans are ready to install using your Original Equipment hardware and the kit includes left- and right-side Footboard Pans. Just add your choice of Footboard Insert for the finishing touch. Footboard Supports sold separately.

Fits '06-'17 Dyna®, '18-later Softail® (except FXDRS, FXFB and FXFBS) and '86-later Touring models equipped with passenger footboard supports. Does not fit Trike models.

50501144 Classic Style. **\$180.95**
50501147 Contemporary Style. **\$180.95**



C. PASSENGER FOOTBOARD PANS – CHROME, CLASSIC STYLE

D. PASSENGER FOOTBOARD PANS – BLACK

Complete the blacked-out transformation. Replace your chrome Passenger Footboard Pans with sinister black. Kit includes left- and right-side Footboard Pans and is installed using the Original Equipment hardware. Custom Footboard Inserts and Footboard Supports sold separately.

Fits '06-'17 Dyna, '18-later Softail (except FXDRS, FXFB and FXFBS) and '86-later Touring models equipped with passenger footboard supports. Does not fit Trike models.

50501610 Classic Style. **\$180.95**
50501611 Contemporary Style. **\$180.95**



D. PASSENGER FOOTBOARD PANS – GLOSS BLACK, CLASSIC STYLE

E. TRADITIONAL STYLE PASSENGER FOOTBOARD PANS – CHROME

Replace the factory black painted passenger footboard with the custom look of smooth chrome. The kit includes left- and right-hand traditional D-shaped footboard pans, chrome-plated, and ready to install with your Original Equipment hardware. Footboard inserts and footboard supports sold separately.

50752-04 **\$180.95**
Fits '06-'17 Dyna, '00-later Softail (except FXDRS, FXFB and FXFBS) and '86-later Touring and Trike models equipped with passenger footboard supports.



E. TRADITIONAL STYLE PASSENGER FOOTBOARD PANS – CHROME

F. SWEEP WING PASSENGER FOOTBOARD PANS

These unique Swept Wing Passenger Footboard pans complement the Swept Wing Rider Footboard shape, and allow you to replace the Original Equipment passenger footpegs on certain models with footboards. When folded, the footboard displays a mirror chrome surface in your choice of smooth or ball-milled, grooved design. Footboard inserts and footboard supports sold separately.

Fits '06-'17 Dyna, '00-later Softail (except FXDRS, FXFB and FXFBS) and '86-later Touring models equipped with passenger footboard supports. Does not fit Trike models.

50716-04 Chrome – Smooth. **\$180.95**
50357-04 Chrome – Grooved. **\$180.95**



D. PASSENGER FOOTBOARD PANS – GLOSS BLACK, CONTEMPORARY STYLE



F. SWEEP WING PASSENGER FOOTBOARD PANS – CHROME SMOOTH OR GROOVED

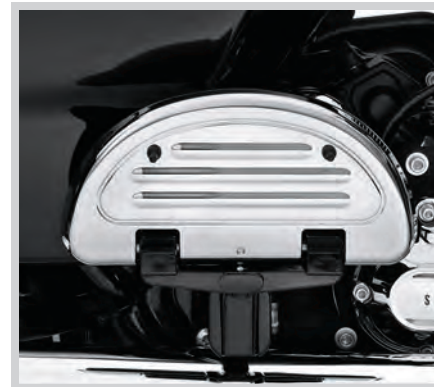

G. HALF-MOON PASSENGER FOOTBOARD PANS – CHROME



G. HALF-MOON PASSENGER FOOTBOARD PANS – GLOSS BLACK



H. ROAD KING CLASSIC PASSENGER FOOTBOARD COVERS



I. CONCHO PASSENGER FOOTBOARD COVERS



J. HARLEY-DAVIDSON SCRIPT PASSENGER FOOTBOARD COVERS

TOURING & TRIKE 287

Foot Controls

G. HALF-MOON PASSENGER FOOTBOARD PANS AND INSERTS

Styled to match the Half-Moon Rider Footboards, these classic passenger footboards add both style and comfort to your nostalgic ride. Available in mirror-finish chrome or gloss black finish, the kit includes left and right footboard pan and vibration-isolation footboard inserts. Model-specific footboard mounts are sold separately.

Fits '06-'17 Dyna®, '00-later Softail® (except FXDRS, FXFB and FXFBS) and '86-later Touring models equipped with passenger footboard supports. Does not fit Trike models.

50807-08 Chrome. **\$221.95**
50810-08 Gloss Black. **\$209.95**

H. ROAD KING® CLASSIC PASSENGER FOOTBOARD COVERS

The latest in the family of Road King® Classic-inspired accessories, this chrome-plated steel footboard cover features a chrome die-cast Road King Classic medallion with black accents and a stylish leather accent piece. Mounting hardware included.

50246-00 **\$84.95**
Fits '06-'17 Dyna, '86-'17 FL Softail and '87-later Touring and Trike models equipped with traditional D-shaped aluminum passenger footboards.

I. CONCHO PASSENGER FOOTBOARD COVERS

Heritage Softail® Classic model-inspired conchos make these covers look great whether footboards are up or down.

50193-96 **\$84.95**
Fits '06-'17 Dyna, '86-'17 FL Softail and '87-later Touring and Trike models equipped with traditional D-shaped aluminum passenger footboards.

J. HARLEY-DAVIDSON SCRIPT PASSENGER FOOTBOARD COVERS

These easy-to-install chrome covers are formed to fit over the stock footboard pan to add a touch of style to the profile of your bike. The simple, clean design features a deep embossed Harley-Davidson script for a finishing touch. Kit includes chrome mounting hardware.

50782-91 **\$74.95**
Fits '06-'17 Dyna, '86-'17 FL Softail and '87-later Touring and Trike models equipped with traditional D-shaped aluminum passenger footboards.

Notice: The prices appearing in this catalog are the manufacturer's suggested retail prices. Actual retail prices may vary.

Notice: The prices appearing in this catalog are the manufacturer's suggested retail prices. Actual retail prices may vary.

288 TOURING & TRIKE

Engine Guards

A. MUSTACHE ENGINE GUARD*

Combine classic shape and modern function for a unique twist on engine protection. The flow of this engine guard complements the bike's traditional style while the gracefully curved upper section incorporates highway pegs into the shape. The integrated rubber pads offer a comfortable and slip-resistant cushion for your feet while traveling the open road. One-piece engine guard kit includes all required mounting hardware.

Fits '09-later Touring and Trike models (except Road Glide®). Does not fit models equipped with fairing lowers. '15-later FLRT models require the separate purchase of Bracket P/N 45700054. '10-'11 FLHXXX models require the separate purchase of Bracket P/N 83865-09.

49155-09B	Chrome.	\$307.95
49442-10A	Gloss Black.	\$307.95

Fits '97-'08 Touring models (except Road Glide). Does not fit models equipped with fairing lowers.

49155-05B	Chrome.	\$307.95
------------------	---------	-----------------



A. MUSTACHE ENGINE GUARD – CHROME



A. MUSTACHE ENGINE GUARD – GLOSS BLACK



B. ENGINE GUARD – CHROME



C. ENGINE GUARD – GLOSS BLACK



D. CENTER STAND



E. CHOPPED ENGINE GUARD – CHROME
(49000105A SHOWN)



E. CHOPPED ENGINE GUARD – GLOSS BLACK
(49000117A SHOWN)



E. CHOPPED ENGINE GUARD – CHROME



F. ENGINE GUARD MOUNTING BRACKET – GLOSS BLACK

TOURING & TRIKE 289

Engine Guards

E. CHOPPED ENGINE GUARD*

Create a sleek, slammed look on your custom bagger with the Chopped Engine Guard. This guard offers a slim, low-profile design that retains function while delivering a unique styling twist. The upper mounts connect midway up the downtube, 11" lower than the stock guard. The minimalistic look reduces the visual mass of the bike, while the mounting point lowers the bike's visual center of gravity. The 1.25" Engine Guard features a slightly forward sweep that provides plenty of room around the brake and shift levers. Easy to install.

Fits '14-later Touring models (except Road Glide® and models equipped with fairing lowers).

49000105A	Chrome.	\$307.95
49000114A	Gloss Black.	\$307.95

Fits '14-later Road Glide models (except models equipped with fairing lowers). Kit includes replacement fairing mount brackets.

49000235	Chrome.	\$327.95
49000117A	Gloss Black.	\$347.95

F. ENGINE GUARD MOUNTING BRACKET – GLOSS BLACK

This bracket locates the steering damper and clutch cable mount when an engine guard is mounted on a FLRT model.

45700054		\$33.95
-----------------	--	----------------

Fits '15-later FLRT models.

***WARNING:** Engine guards may provide limited leg and cosmetic vehicle protection under unique circumstances (fall over while stopped, very low speed slide). They are not made nor intended to provide protection from bodily injury in a collision with another vehicle or any other object.

***WARNING:** Do not use engine guard footpegs under normal stop and go operating conditions. Doing so could result in death or serious injury.

***WARNING:** Do not use highway pegs under normal stop and go operating conditions. Doing so could result in death or serious injury.

***WARNING:** Engine guards may provide limited leg and cosmetic vehicle protection under unique circumstances (fall over while stopped, very low speed slide). They are not made nor intended to provide protection from bodily injury in a collision with another vehicle or any other object.

***WARNING:** Do not use engine guard footpegs under normal stop and go operating conditions. Doing so could result in death or serious injury.

***WARNING:** Do not use highway pegs under normal stop and go operating conditions. Doing so could result in death or serious injury.

Notice: The prices appearing in this catalog are the manufacturer's suggested retail prices. Actual retail prices may vary.

Notice: The prices appearing in this catalog are the manufacturer's suggested retail prices. Actual retail prices may vary.

290 TOURING & TRIKE

Suspension

PREMIUM ADJUSTABLE PERFORMANCE SUSPENSION

Step up to the ultimate in handling and ride quality. Screamin' Eagle®/Öhlins® Remote Reservoir Rear Shocks for Harley-Davidson® Touring models were designed for Screamin' Eagle® Factory Team race bikes and it's what the Wymans had on their Road Glide® Special motorcycles. Fully adjustable for preload and compression/rebound damping, with a remote reservoir for optimal performance and style. Use these shocks to dial in your ideal combination of handling and ride, for the street or the track. Ride like a winner.



A. SCREAMIN' EAGLE®/ÖHLINS® REMOTE RESERVOIR REAR SHOCKS

TOURING & TRIKE 291

Suspension

A. SCREAMIN' EAGLE®/ÖHLINS® REMOTE RESERVOIR REAR SHOCKS

Upgrade to Screamin' Eagle® Factory Race Team suspension with these performance rear shocks. These high-performance rear shocks for Touring models were designed with Öhlins® specifically for Screamin' Eagle® Factory Team race bikes. Now you can experience the ultimate in handling and ride quality with these Screamin' Eagle®/Öhlins® Remote Reservoir Rear Shocks. These mono tube remote reservoir shocks are completely adjustable to match your riding style. Set the sag with the adjustable preload then fine tune the response with adjustable compression and rebound damping. These shocks perform great and add a performance style with a remote reservoir and exposed adjusters.

- Get a perfect factory fit. Reservoir brackets are designed to accommodate all Harley-Davidson® accessories
- Expertly tuned by Öhlins and Screamin' Eagle for the aggressive performance bagger rider in mind
- Preload setting on both shocks allows suspension adjustment based on rider, passenger, and gear weight for optimal performance
- No tools required for compression and rebound damping adjustments so changes can be made quickly and easily
- High-performance style: Exposed remote reservoirs with stainless steel lines and Screamin' Eagle/Öhlins branding
- Progressive rate springs stiffen quickly for improved control when you pick up the pace
- Standard Height with +8/-2 mm of length adjustment
- High-pressure nitrogen gas-charged design resists heat fading
- Low-friction shaft/seal head design for smooth performance
- 36mm piston diameter
- Includes billet aluminum preload adjustment tool

Fully serviceable and rebuildable

Fits '14-later Touring models (except FLHTKL and FLHTCUL).

54000193

\$1,521.95

1 COMPRESSION ADJUSTER

Fine-tunes suspension to control the upward wheel movement when hitting a bump

Adjusts the speed at which the suspension compresses

Critical for balancing ride quality and suspension bottoming

2 REBOUND ADJUSTER

Fine-tunes the downward wheel movement after riding over bumps or potholes

Adjusts the speed at which the suspension returns from extension

Critical for balancing ride quality and suspension bounce

3 PRELOAD ADJUSTER

Critical to setting the proper suspension travel to soak up large potholes and absorb large bumps

Adjusts for rider sag—the amount the suspension drops under the weight of the rider and cargo



4 REMOTE RESERVOIR

Remote reservoir keeps the shock oil cooler to maintain damping performance

Internal bladder separates the oil from the nitrogen gas to reduce cavitation during aggressive riding

5 LENGTH

The shock length is adjustable from +8mm or -2mm over the standard height.



A. SCREAMIN' EAGLE®/ÖHLINS® REMOTE RESERVOIR REAR SHOCKS



292 TOURING & TRIKE

Suspension

A. PREMIUM RIDE SINGLE CARTRIDGE FORK KIT ^{1,2}

The Cartridge Fork Kit complements the Premium Ride Hand-Adjustable Rear Shocks by providing a balanced suspension system capable of delivering superior ride characteristics. The front fork kit improves resistance to front brake dive, improves cornering and enhances bottoming control. The kit includes fork pipes, cartridges, fork bolts, main springs and oil seals. Available in Standard Ride Height and Low Ride Height versions.

45500158 Standard-Height. **\$372.95**
Fits '14-'16 Touring models. Does not fit Trike models.

45500157 Low-Profile. **\$372.95**
Fits '14-'16 Touring models. Does not fit Trike models. Stock on '15-'16 FLHTCUL and FLHTKL models. Must only be installed on vehicles equipped with lowered rear shocks.

B. PROFILE® LOW TOURING FRONT SUSPENSION ^{1,2}

Original Equipment on the Electra Glide® Ultra Low model, this front suspension kit reduces the front fork length by over .7", reducing seat height and delivering a closer to the pavement riding experience. This Profile® Low front suspension utilizes Dual Bending Valve technology to preserve original ride quality, and features springs that are wound to allow a compliant, yet controlled ride. When paired with the required Low-Profile Hand-Adjustable Rear Suspension, the overall ride height is reduced, providing a rider with a short inseam additional confidence when stopped or maneuvering a vehicle in a parking lot. The kit includes two fork springs, two damper tubes, jiffy stand mount, seals and hardware.

45400218 **\$170.95**
Fits '17-Later Touring models equipped with lowered rear shocks (except FLHTKL and '18-later FLTRXSE models). Does not fit Trike models. FLHR, FLHRC, FLHTCU, FLHTK, FLHTKSE, FLHXST, FLTRU, FLTRK, FLTRKSE and FLTRXST models require installation of lowered rear shocks. Does not fit with 21" wheels.

C. PREMIUM RIDE FRONT FORK KIT – TRIKE MODELS

This Front Fork Kit provides improved handling performance by keeping the tire in contact with the road surface and features the Showa® Dual Bending Valve technology. This technology increases the dampening control of the fork, equaling the finest in both comfort and control for Trike riders.

45400219 **\$457.95**
Fits '14-'18 FLHTCUTG models. Original Equipment on '19-later models.

D. PREMIUM RIDE DOUBLE CARTRIDGE FORK KIT ¹

The Double Cartridge Fork Kit complements the Premium Ride Hand-Adjustable Rear Shocks by providing a balanced suspension system capable of delivering superior ride characteristics. The front fork kit improves resistance to front brake dive, improves cornering and enhances bottoming control. The kit includes fork pipes, cartridges, fork bolts, main springs and oil seals.

45500106 Standard-Height. **\$457.95**
Fits '09-'13 Touring models. Does not fit Trike models.



A. PREMIUM RIDE SINGLE CARTRIDGE FORK KIT



B. PROFILE LOW TOURING FRONT SUSPENSION



C. PREMIUM RIDE FRONT FORK KIT – TRIKE MODELS



D. PREMIUM RIDE DOUBLE CARTRIDGE FORK KIT



¹WARNING: Installation of any accessory suspension components may affect cornering clearance and jiffy stand operation. This could distract the rider, causing loss of control and death or serious injury.



²WARNING: The Profile Low Front Suspension cannot be used independently and must be used with the appropriate lowered rear suspension kit. Installation of any accessory suspension components may affect cornering clearance and jiffy stand operation. This could distract the rider, causing loss of control and death or serious injury.

Notice: The prices appearing in this catalog are the manufacturer's suggested retail prices. Actual retail prices may vary.



E. PREMIUM RIDE HAND-ADJUSTABLE TOURING SHOCKS



F. PREMIUM RIDE HAND-ADJUSTABLE TOURING SHOCKS – LOW



G. PROFILE LOW TOURING AIR SHOCKS*



H. ANALOG TOURING SUSPENSION AIR PUMP

TOURING & TRIKE 293

Suspension

E. PREMIUM RIDE HAND-ADJUSTABLE TOURING SHOCKS*

Experience the ultimate in superior ride quality with these Premium Touring Shocks. These shocks utilize a single tube, nitrogen charged emulsion design. The design offers enhanced compression and rebound damping compared to the Original Equipment-style air adjustable shocks. This provides a controlled yet plush ride with much less bottoming. Larger chambers (40mm diameter pistons and 14mm rods) allow these shocks to react more quickly to impacts. This keeps the tires tracking while minimizing harshness transmitted through the frame. A simple knob behind the left saddlebag allows the rider to conveniently modify the spring preload via a hydraulic adjuster. Available in Standard Ride Height and Low Ride Height versions.

54000008 Standard-Height. **\$584.95**
Fits '09-'16 Touring models (except models equipped with lowered front ends).

54000091 Low-Profile. **\$584.95**
Fits '09-'16 Touring models. Does not lower '09-'16 FLHX, FLTRX, and '09 FLTRSE models. Stock on FLHTCUL, FLHTKL, FLHXS, FLTRXS, '13 FLHRSE, '10-'12 FLHXSE, '15-'16 FLHXSE, and '12-'13 FLTRXSE models.

F. PREMIUM RIDE HAND-ADJUSTABLE TOURING SHOCKS – LOW*

Original Equipment on the Ultra Limited Low model, this low-profile rear suspension system is engineered to minimize ride height while maximizing comfort for the rider and passenger. Featuring a single tube, nitrogen charged emulsion design, these shocks deliver enhanced compression and rebound damping for a controlled and comfortable ride with much less bottoming. The shocks feature large chambers that allow the suspension to react quickly to impacts, keeping the tires tracking while minimizing harshness transmitted through the frame. A simple knob behind the left saddlebag permits adjustment of the spring preload to adapt for light or heavy load. Installation of this low profile rear suspension reduces seat height by .75" to deliver a confidence-inspiring shorter reach to the ground. Kit includes left and right rear shocks.

54000159 **\$584.95**
Fits '17-later FLHR, FLHRC, FLHTCU, FLHTK, FLHTKSE, FLHXST, FLTRK, FLTRKSE, FLTRU and FLTRXST models.

G. PROFILE® LOW TOURING AIR SHOCKS*

Lower the seat height of your Touring model without compromising the ride. The Profile® Low Touring Shocks have been re-valved for a comfortable ride while lowering the seat height by up to .75". The kit maintains the air adjustability feature of the stock shocks.

54635-09 **\$331.95**
Fits '09-'16 Touring models. Does not lower '09-'16 FLHX, FLHXS, FLTRX, FLTRXS, FLHTCUL, FLHTKL, FLHRSE, FLTRSE and FLTRXSE models. Does not fit Trike models.

H. ANALOG TOURING SUSPENSION AIR PUMP

Aluminum housing is compact, lightweight and durable, and fits easily into your bag for on-the-road adjustments. The high-quality 0-60 psi gauge ensures accurate air pressure.

54630-03A **\$57.95**
For use with Touring air suspension components.



¹WARNING: Installation of any accessory suspension components may affect cornering clearance and jiffy stand operation. This could distract the rider, causing loss of control and death or serious injury.

Notice: The prices appearing in this catalog are the manufacturer's suggested retail prices. Actual retail prices may vary.

294 TOURING & TRIKE

Front Forks

A. LOWER FORK SLIDERS – CHROME

Competitively priced, these chrome-plated Lower Fork Sliders give your bike upfront style. To ensure proper fitment and function, these sliders are manufactured from Original Equipment components. A perfect addition during the installation of Premium Ride or Profile® Low Front suspension components, the kit features polished, triple chrome-plating.

45500171 **\$524.95**
Fits '14-later Touring models. Does not fit Trike models.

45500200 **\$524.95**
Fits '14-later Trike models.

45500167 **\$524.95**
Fits '00-'13 Touring models.

B. LOWER FORK SLIDERS – GLOSS BLACK

These gloss black coated sliders are the ultimate extension of your bike's "dark side" and make a perfect custom addition to your blacked-out ride. Manufactured to Original Equipment specifications, the durable black coating is a great match to other H-D® black components. A perfect addition during the installation of Premium Ride or Profile Low front suspension components, this includes right and left sliders.

45500172B **\$514.95**
Fits '14-later Touring models. Does not fit Trike models.

46546-03 **\$514.95**
Fits '00-'13 Touring models.



A. LOWER FORK SLIDERS – CHROME



B. LOWER FORK SLIDERS – GLOSS BLACK



C. FRONT END KIT – CHROME '14-LATER MODELS



D. FRONT END KIT – GLOSS BLACK '14-LATER MODELS



E. UPPER FORK SLIDER COVERS – CHROME



F. UPPER FORK SLIDER COVERS – GLOSS BLACK

TOURING & TRIKE 295

Front Forks

C. FRONT END KIT – CHROME

The front forks on a Harley-Davidson® motorcycle set the tone for the bike, and can lead the way to a full-bore custom statement. So start customizing by adding chrome where it will have the most noticeable impact on the overall look of the bike: the front end. A perfect addition during the installation of Premium Ride or Profile® Low Front suspension components. This package includes components necessary to completely chrome the front forks and includes Chrome Fork Sliders, Chrome Upper Fork Slider Covers and Classic Chrome Front Axle Nut Covers (kit components vary depending on model).

45800037 **\$652.95**
Fits '14-later Touring models.

45800035 **\$652.95**
Fits '08-'13 Touring models (except models with ABS option).

45800034 **\$652.95**
Fits '08-'13 Touring models with ABS option.

45800036 **\$652.95**
Fits '00-'07 Touring models.

D. FRONT END KIT – GLOSS BLACK

Lead the way to the dark side. This complete blacked-out Front End Kit includes all the major components required to convert the Original Equipment satin-finished front end to a dark custom style. A perfect addition during the installation of Premium Ride or Profile Low Front suspension components. This package includes Gloss Black Fork Sliders, Gloss Black Upper Fork Slider Covers, Gloss Black Front Axle Nut Covers and Gloss Black Outer Fairing Skirt.

45800038B **\$642.95**
Fits '14-later Touring models (except Road King® and Road Glide® models) Does not fit Trike models.

45800022 **\$642.95**
Fits '08-'13 Electra Glide® and Street Glide® models.

E. UPPER FORK SLIDER COVERS – CHROME

Brilliant chrome accents for the upper fork legs. Perfect for finishing off that chromed front end look. When used with H-D® Genuine Motor Accessory Chrome Lower Fork Sliders, you've got a front end that's completely chromed and an appearance that's utterly impressive.

45600022 **\$100.95**
Fits '14-later Touring and Trike models.

45963-97 **\$84.95**
Fits '49-'84 FL, '86-'17 FLS, FLSS, FLST, FLSTC, FLSTF (except '07), FLSTFB, FLSTFBS and FLSTN and '80-'13 Touring and Trike models. Stock on FLSTNSE and FLSTSE models.

F. UPPER FORK SLIDER COVERS – GLOSS BLACK

The classic Harley-Davidson® motorcycle color is black. It shows your attitude, your feelings and your desire to be different from the rest. These gloss black accessories are the ultimate extension of the Harley-Davidson philosophy. Manufactured from Original Equipment components, these parts provide superior fit and finish.

45600023 **\$100.95**
Fits '14-later Touring and Trike models.

45591-02 **\$84.95**
Fits '49-'84 FL, '86-'17 FLS, FLSS, FLST, FLSTC, FLSTF (except '07), FLSTFB, FLSTFBS, FLSTNSE and FLSTN, '10-'12 FLSTSE and '80-'13 Touring and Trike models.

Notice: The prices appearing in this catalog are the manufacturer's suggested retail prices. Actual retail prices may vary.

Notice: The prices appearing in this catalog are the manufacturer's suggested retail prices. Actual retail prices may vary.

296 TOURING & TRIKE

Suspension Trim & Brakes

A. FRONT FORK AIR BAFFLE – CHROME

Deflect the cold night wind rushing between the fork tubes of your Touring model. This stylish chrome air baffle replaces the Original Equipment black baffle on '00-earlier models. Includes chrome mounting hardware.

58520-79TC **\$38.95**

Fits '80-'13 FLHR, FLHT, FLHX and FLT models.
Does not fit Trike models.



A. FRONT FORK AIR BAFFLE – CHROME

B. BRAKE CALIPER KIT – RED

Dress your bike in the latest high-performance look. Brilliant red calipers make a powerful visual statement, and set your bike apart from the ordinary. Manufactured from Original Equipment components for proven performance, these calipers will add a stylish touch to the stock bike, or add the perfect finish to a complete custom equipped with chrome or blacked-out wheels, rotors and fork sliders.

41300116 Front – Dual Disc. **\$532.95**

Fits '06-'17 VRSC™, '08-later Touring and '09-'13 and '19-later Trike models. Brake pads sold separately.

C. BRAKE CALIPER KIT – CHROME

Add the shine of chrome to your bike with these highly polished Chrome Brake Caliper Kits. Manufactured from Original Equipment components for proven performance, these calipers are a great addition to the stock bike, or add the finishing touch to a complete custom equipped with chrome wheels, rotors and fork sliders.

42012-06A Front – Dual Disc. **\$956.95**

Fits '06-'17 VRSC, '08-later Touring and '09-'13 and '19-later Trike models. Brake pads sold separately.

41300181 Front – Dual Disc. **\$998.95**

Fits '14-later Trike models. Brake pads sold separately.



B. FRONT BRAKE CALIPER KIT – RED (41300116 SHOWN)



C. FRONT BRAKE CALIPER KIT – CHROME (42012-06A SHOWN)

D. CALIPER SCREEN INSERT – CHROME

These chrome-plated Caliper Inserts replace the Original Equipment satin-finish screens featured on Brembo® brake calipers. Easy pop-in installation. Sold individually.

42054-05 Front. **\$33.95**

Fits '06-'17 VRSC, '08-later Touring and '09-'13 and '19-later Trike models.

E. CALIPER SCREEN INSERT – GLOSS BLACK

Complete the blacked-out transformation. Gloss black inserts replace the satin-finish screens featured on Harley-Davidson® Original Equipment Brembo® brakes, and add a rich complement to the wrinkle black caliper finish. Easy pop-in installation. Sold individually.

41300154 Front. **\$33.95**

Fits '06-'17 VRSC, '08-later Touring and '09-'13 and '19-later Trike models.



D. CALIPER SCREEN INSERT – CHROME



E. CALIPER SCREEN INSERT – GLOSS BLACK

F. FRONT WHEEL SPACERS – CHROME

There's always more room for chrome with these highly polished chrome wheel spacers. They are manufactured to the Original Equipment tolerances, so you get exact product fitment and quality.

41371-08 Domed. **\$54.95**

Fits '08-later Touring models with ABS brakes.



F. FRONT WHEEL SPACERS – CHROME, DOMED

G. FRONT WHEEL SPACERS – GLOSS BLACK

It is all in the details. Complete your total front end with these wheel spacers in gloss black. Manufactured to the Original Equipment tolerances, they deliver the exact fitment and custom shine.

42400016 Domed. **\$57.95**

Fits '08-later Touring models with ABS brakes.



G. FRONT WHEEL SPACERS – GLOSS BLACK, DOMED



H. FORK AXLE RETAINER NUT KIT – CHROME



TOURING & TRIKE 297

Brake Trim

H. FORK AXLE RETAINER NUT KIT – CHROME

It's the details that count. Complete the chrome transformation by adding this finishing touch to your chrome fork sliders. This Axle Retainer Nut Kit includes the stylish chrome-plated nuts and chrome lockwashers necessary to replace the stock hardware.

45813-03 **\$27.95**

Fits '91-'05 FXDWG, '86-'07 FLST, FLSTC, FLSTF and FLSTN, '91-'07 FXST and FXSTB and '84-'13 Touring and Trike models.

Also available:

FORK SLIDER DRAIN SCREW KIT – CHROME

It's the details that count. Complete the chrome transformation by adding this finishing touch to your chrome fork sliders. This Fork Slider Drain Screw Kit includes two chrome-plated drain screws and the seals required to replace the stock hardware.

45848-03 **\$4.95**

Fits '93-'05 FXDWG, '87-'17 Softail® (except Springer™, FXCW, FXCWC, FXSB, FXSBSE, FXSE and FXSTD) and '87-'13 Touring and Trike models.

I. CUSTOM CALIPER BOLT COVER KIT

Cover your 12-point caliper bolts in chrome. These easy-to-install chrome covers are held firmly in place with a steel spring clip, and are styled to match the Chrome Rocker Box Bolt and Headbolt Covers.

40955-05 Four Large and Two Small Covers. **\$32.95**

Fits '00-later front brake calipers (except Springer, '06-later VRSC™, '04-'22 XL, '15-later XG, '16-'17 FXDLS, '18-later Softail, '08-later Touring and Trike and models equipped with caliper covers). Also fits rear calipers on '06-'17 Softail models (except FXCW and FXSE).

40959-05 Three Large and Two Small Covers. **\$27.95**

Fits '00-later rear brake calipers (except Springer, '06-later VRSC, '04-'22 XL, '15-later XG, '16-'17 FXDLS, '18-later Softail, '08-later Touring and Trike and models equipped with caliper covers). Also fits rear calipers on '06-'17 Softail models (except FXCW, FXSE).

J. 1. BRAKE BLEEDER SCREW COVER

This cover adds chrome to the unfinished bleeder valve on all stock H-D® calipers. Package of two.

43834-98 **\$27.95**

Fits '84-later stock calipers (except XG and XR models).

2. BANJO BOLT COVER

Die-cast chrome cover provides a custom look to your stock banjo bolts. Fits banjo bolts on front and rear brake master cylinders and front and rear calipers. Installs in seconds.

32715-98 **\$26.95**

Fits '84-later models with stock master cylinders and calipers. (Does not fit VRSC Rear Master Cylinder, '06-'17 VRSC calipers, '15-later XG, '04-'22 XL, or '08-later Dyna®, Softail, Touring and Trike models).

K. BRAKE CALIPER INSERTS

Easy-to-install inserts add a finishing touch to the front and rear brake calipers. Select a style that follows your custom direction. Self-adhesive backing.

Fits '00-later front and rear brake calipers on all models (except Springer front, '06-later VRSC, '15-later XG, '04-'22 XL, '18-later Softail rear caliper, and '08-later Touring and Trike).

1. 44477-99 Classic Chrome. **\$20.95**

2. 44476-99 Harley-Davidson Script. **\$20.95**



I. CUSTOM CALIPER BOLT COVER KIT – (40955-05 SHOWN)

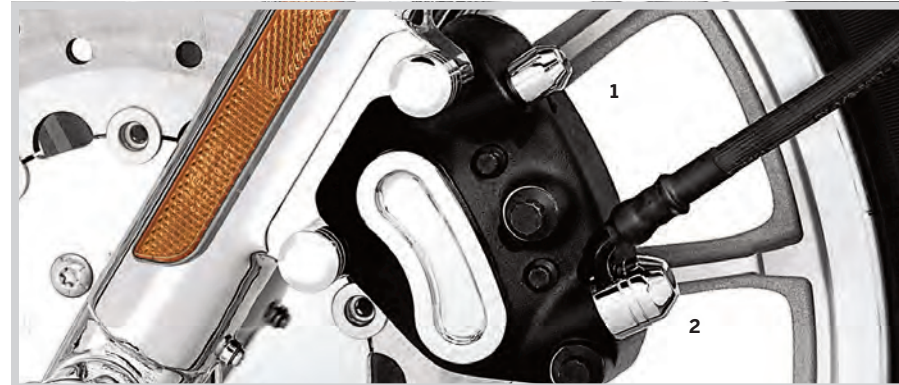

J. BLEEDER SCREW AND BANJO BOLT COVERS



K. BRAKE CALIPER INSERTS



L. BRAKE CALIPER TRIM DISCS

L. BRAKE CALIPER TRIM DISCS

Available in 1.375" and 1.75" diameters to accommodate front and rear calipers on most '99-earlier models, and front calipers on '00-later Springer models. Easy to install.

1. 44095-96 H-D Motor Co. – 1.375" Diameter. **\$20.95**

1. 44093-96 H-D Motor Co. – 1.75" Diameter. **\$20.95**

2. 99661-92T Gold Live to Ride – 1.375" Diameter. **\$20.95**

2. 99663-92T Gold Live to Ride – 1.75" Diameter. **\$20.95**

Notice: The prices appearing in this catalog are the manufacturer's suggested retail prices. Actual retail prices may vary.

Notice: The prices appearing in this catalog are the manufacturer's suggested retail prices. Actual retail prices may vary.

298 TOURING & TRIKE

Front Axle Nut Covers

FRONT AXLE NUT COVERS

Cover the front axle in style. Available in your choice of styles, these custom Axle Nut Covers look great with Original Equipment satin-finish fork sliders or add the finishing touch to a complete chrome or blacked-out front end. Easy to install kits include all necessary mounting hardware. Sold in pairs.

Fits '02-'11 VRSC™ (except VRSCF and VRSCR), '15-'20 XG, '08-'22 XL, '08-'17 Dyna®, '07-later Softail® (except Springer™, FLSTNSE, FXCW, FXCWC, FXSB, FXSBSE, FXSE, FXST-Aus, and FXSTD) and '08-later Touring and Trike models. '18-later FLDE, FLFB, FLFBS, FLHC, FLHCS, FLSB, FLSL, FXBB, FXBBS, FXBR, FXBRS and FXLR models require separate purchase of Front Axle Adapter Kit P/N 43000090. '19-'20 FXDRS, '18-later FXFB and FXFBS and '20-later FXLRS and FXLRST models. require separate purchase of Front Axle Adapter Kit P/N 43000159.

A. DOMINION™ COLLECTION FRONT AXLE NUT COVERS

Express your bold, renegade attitude. The machined aluminum Dominion™ Collection Front Axle Nut Covers add style to the front of the bike and are the perfect complement to other Dominion Collection accessories.

43000124	Gloss Black.	\$79.95
43000123	Bronze.	\$79.95

B. MACHINE CUT FRONT AXLE NUT COVERS

Add some edgy custom detail to the front end and express big attitude with contrasting style.

43000212	Black Machine Cut.	\$65.95
-----------------	--------------------	----------------

C. CHROME FRONT AXLE NUT COVERS

44117-07A	Die-cast.	\$33.95
44116-07A	Billet.	\$53.95

D. GLOSS BLACK FRONT AXLE NUT COVERS

43000026	Die-cast.	\$33.95
43428-09	Billet.	\$53.95

E. ALUMINATOR® FRONT AXLE NUT COVERS

Chrome-plated billet aluminum axle covers feature a classic Bar & Shield logo insert. Includes all necessary mounting hardware for easy installation.

44114-07		\$53.95
-----------------	--	----------------



A. DOMINION FRONT AXLE NUT COVERS – GLOSS BLACK



A. DOMINION FRONT AXLE NUT COVERS – BRONZE



B. MACHINE CUT FRONT AXLE NUT COVERS



C. CHROME FRONT AXLE NUT COVERS



D. GLOSS BLACK FRONT AXLE NUT COVERS



E. ALUMINATOR FRONT AXLE NUT COVERS



F. H-D MOTOR CO. LOGO FRONT AXLE NUT COVERS – GLOSS BLACK



G. H-D MOTOR CO. LOGO FRONT AXLE NUT COVERS – CHROME



H. WILLIE G SKULL FRONT AXLE NUT COVERS – GLOSS BLACK



H. WILLIE G SKULL FRONT AXLE NUT COVERS – CHROME



I. BRASS COLLECTION FRONT AXLE NUT COVERS



TOURING & TRIKE 299

Front Axle Nut Covers

FRONT AXLE NUT COVERS

Fits '02-'11 VRSC™ (except VRSCF and VRSCR), '15-'20 XG, '08-'22 XL, '08-'17 Dyna®, '07-later Softail® (except Springer™, FLSTNSE, FXCW, FXCWC, FXSB, FXSBSE, FXSE, FXST-Aus, and FXSTD) and '08-later Touring and Trike models. '18-later FLDE, FLFB, FLFBS, FLHC, FLHCS, FLSB, FLSL, FXBB, FXBBS, FXBR, FXBRS and FXLR models require separate purchase of Front Axle Adapter Kit P/N 43000090. '19-'20 FXDRS, '18-later FXFB and FXFBS and '20-later FXLRS and FXLRST models. require separate purchase of Front Axle Adapter Kit P/N 43000159.

F. H-D MOTOR CO. LOGO FRONT AXLE NUT COVERS – GLOSS BLACK

Cover the front axle in style. Drenched in gloss black and trimmed with deep cut, silver-filled Harley-Davidson Motor Co. lettering, these Axle Nut Covers are an aggressive twist on a classic style. The covers look great with Original Equipment satin-finish fork sliders or are the perfect finishing touch to complete a blacked-out front or rear end. These easy-to-install kits include all necessary mounting hardware. Sold in pairs.

43000177	Gloss Black.	\$35.95
-----------------	--------------	----------------

G. H-D MOTOR CO. LOGO FRONT AXLE NUT COVERS – CHROME

Die-cast, chrome-plated covers feature the Harley-Davidson Motor Co. logo in black. Includes Allen®-head set screws and wrench for easy installation.

44148-07A		\$35.95
------------------	--	----------------

H. WILLIE G SKULL FRONT AXLE NUT COVERS

Penned at the hand of Willie G, the famous Skull Collection adds a little attitude to your ride. Completely drenched in black or chrome with black filled accents, the raised skull and surrounding Harley-Davidson Motorcycle script adds a subtle ominous touch to your ride. The Axle Nut Covers are easy to install and include all necessary mounting hardware. Sold in pairs.

43000096	Black.	\$38.95
43163-08A	Chrome.	\$38.95

I. FRONT AXLE NUT COVERS – BRASS COLLECTION

Cover the front axle in style. Artistically manufactured from solid brass, these components feature a natural antique finish that will age and patina when exposed to the elements. Brass Collection Axle Nut Covers look great with Original Equipment satin-finish fork sliders or as the finishing touch to a blacked-out front end. Easy-to-install kits include all necessary mounting hardware. Sold in pairs.

43000046		\$64.95
-----------------	--	----------------

Fits '02-'11 VRSC (except VRSCF and VRSCR), '15-'20 XG, '08-'22 XL (except '16-'22 XL1200X and XL1200XS), '08-'17 Dyna, '07-later Softail (except Springer, FLSTNSE, FLSB, FXCW, FXCWC, FXDRS, FXFB, FXFBS, FXLRS, FXSB, FXSBSE, FXSE, FXST-Aus, and FXSTD) and '08-later Touring and Trike models. '18-later FLDE, FLFB, FLFBS, FLHC, FLHCS, FLSL, FXBB, FXBBS, FXBR, FXBRS, FXLR and FXST models require separate purchase of Front Axle Adapter Kit P/N 43000090. '19-'20 FXDRS, '18-later FLSB, FXFB and FXFBS and '20-later FXLRS and FXLRST models require separate purchase of Front Axle Adapter Kit P/N 43000159.

J. CHROME FRONT AXLE NUT COVERS

Fits '04-'07 Dyna (except '07 FXDSE and '04-'05 FXDWG) and '00-'07 Touring models.

43062-04	Chrome – Die-cast.	\$33.95
43061-04	Chrome – Billet.	\$53.95

Fits '88-'07 XL, '91-'03 FXD, FXDX, FXDXT, FXDL, FXDS-CONV, '93-'05 FXDWG, '88-'07 FXR, '87-later FLXR, FXRS-SP and FXWG, '84-'06 Softail (except Springer and FXSTD) and '80-'99 Touring models.

43899-86A	Chrome – Die-cast.	\$33.95
------------------	--------------------	----------------

K. H-D MOTOR CO. LOGO FRONT AXLE NUT COVERS

Fits '04-'07 Dyna (except '07 FXDSE and '04-'05 FXDWG) and '00-'07 Touring models.

43864-96		\$35.95
-----------------	--	----------------

Fits '88-'07 XL, '91-'03 FXD, FXDX, FXDXT, FXDL, FXDS-CONV, '93-'05 FXDWG, '88-'07 FXR, '87-later FLXR, FXRS-SP and FXWG, '84-'06 Softail (except Springer and FXSTD) and '80-'99 Touring models.



J. CHROME FRONT AXLE NUT COVERS



K. H-D MOTOR CO. LOGO FRONT AXLE NUT COVERS

Notice: The prices appearing in this catalog are the manufacturer's suggested retail prices. Actual retail prices may vary.

Notice: The prices appearing in this catalog are the manufacturer's suggested retail prices. Actual retail prices may vary.

300 TOURING & TRIKE

Chassis Trim

A. OIL COOLER COVER

Dress the Touring oil cooler in style. This Oil Cooler Cover is designed to hug the contours of the cooler body and does not interfere with the engine guard or voltage regulator. The forward-facing mesh screen adds a custom touch, and protects the oil cooler fins from road debris without disturbing the airflow across the surface. Available in your choice of chrome or gloss black finish, the easy-to-install cover kit includes all required mounting hardware.

Fits '17-later FLHR, FLHRC, FLHT, FLHX, FLHXS, FLHXST, FLTRX, FLTRXS and FLTRXST models. Does not fit models equipped with fairing lowers. Does not fit with Fan-Assisted Oil Cooler P/N 62700204 or Bolt-On Oil Cooler Fan P/N 26800195.

25700633	Chrome.	\$160.95
25700634	Gloss Black.	\$160.95

B. OIL COOLER COVER KIT – CHROME

Dress the Touring Oil Cooler in style. This Chrome Oil Cooler Cover is designed to hug the contours of the cooler body while allowing complete airflow across the surface. Includes required mounting hardware.

63121-11A **\$64.95**
Fits '11-'16 Touring and Trike models (except models equipped with Twin-Cooled™ engines).

C. COLOR-MATCHED CHIN SPOILER

The Touring Chin Spoiler Kit gives a touch of factory color and style to the front of your Touring motorcycle. Kit includes all the required mounting hardware. Best of all, it's Genuine Harley-Davidson for the perfect fit and unmatched custom style.

Fits '17-later Road King®, Street Glide®, Road Glide® (except FLTRXSE models), and Electra Glide® Standard models.

See the Color-Shop Section for a complete list of available colors.



A. OIL COOLER COVER – CHROME



A. OIL COOLER COVER – GLOSS BLACK



B. OIL COOLER COVER KIT – CHROME
'11-'16 TOURING



C. COLOR-MATCHED CHIN SPOILER



D. CUSTOM REAR FENDER SYSTEM – WITH CUSTOM VIVID BLACK PAINT – '14-LATER DOMESTIC MODELS



D. CUSTOM REAR FENDER SYSTEM – '14-LATER DOMESTIC MODELS



D. CUSTOM REAR FENDER SYSTEM – '14-LATER INTERNATIONAL MODELS



D. CUSTOM REAR FENDER SYSTEM – '09-'13 DOMESTIC MODELS

TOURING & TRIKE 301

Custom Bagger – Bodywork

D. CUSTOM REAR FENDER SYSTEM – PRIMED

This custom rear fascia and fender kit keeps the back of your bike clean, classy and simple. Originally featured on CVO™ Touring models, this kit smoothly blends the shape of the rear fender into the saddlebags and hides the saddlebag mounting structure.

Fits '14-later Touring models (except FLHRC and CVO™ models). Does not fit models equipped with Saddlebag Guard Rails P/N 9020056, 90201902 or 90201903. Requires Separate purchase of Rear Tail Light P/N 67801090 (U.S. Domestic) or 67801091 (HDI). Does not fit Canada models.

59500246A **\$672.95**
Domestic and HDI (except Canada).

Fits '14-later Canadian Touring models (except FLHT, FLHRC and CVO™ models). Does not fit models equipped with Saddlebag Guard Rails P/N 90200561, 90201902 or 90201903.

59500245A **\$1,134.95**
Canada.

Fits '09-'13 Touring models (except FLHRC). FLHTC and FLHTCU models require separate purchase of Saddlebag Support Kit P/N 90881-09.

59500105BEO **\$1,134.95**
Domestic.

Notice: The prices appearing in this catalog are the manufacturer's suggested retail prices. Actual retail prices may vary.

Notice: The prices appearing in this catalog are the manufacturer's suggested retail prices. Actual retail prices may vary.

302 TOURING & TRIKE

Headlamp & Fender Trim

A. STREET GLIDE® FRONT BULLET TURN SIGNAL MOUNT KIT – GLOSS BLACK

Complement the lean, stripped-down look of your Street Glide® model. Manufactured from Original Equipment components, these rich gloss black Turn Signal Mounts replace the factory-installed chrome mounts to complete the blacked-out look. The brackets serve as stylized mounting points for the Original Equipment or accessory LED bullet turn signals, and conceal the wiring for a clean, custom appearance. Kit includes left and right mounting bracket.

67800706 **\$107.95**
Fits '14-later FLHX, FLHXS and FLHXSE models.



A. STREET GLIDE FRONT BULLET TURN SIGNAL MOUNT KIT – GLOSS BLACK



B. ROAD GLIDE FRONT BULLET TURN SIGNAL MOUNTS – GLOSS BLACK



C. FRONT FENDER TRIM KIT – CHROME

C. FRONT FENDER TRIM KIT – CHROME

Replace the Original Equipment stainless steel fender trim with a splash of chrome. Kit includes left and right side trim strip.

59209-91T **\$33.95**
Fits '86-'17 FLSTC and FLSTN and '82-'13 Touring models (except Road Glide® and Road King® Custom). Does not fit models equipped with clean front fender.

D. AIR WING FRONT FENDER RAIL*

Shaped by the wind, this aerodynamic front fender rail features an inverted-wing tip and support rails that complement the sweeping lines of the fender. As a stylish replacement for the traditional rubber bumper and rails, the completed installation mirrors the design of the Original Equipment fender tip and spears. The hidden hardware adds to the clean, custom appearance. The mirror chrome surface and embossed Harley-Davidson lettering finishes the look.

59600022 **\$117.95**
Fits '14-later FLHTCU, FLHTCUL, FLHTK and FLHTKL models.



D. AIR WING FRONT FENDER RAIL

E. V-LOGO FRONT FENDER RAIL*

A stylish re-creation of a popular Hydra Glide accessory, this twin tube design sweeps smartly back along the front fender. Matching Touring V-Logo Rear Fender Rail P/N 91100-94 integrates the styling from front to rear. Includes mounting hardware and installation instructions.

91099-94A **\$107.95**
Fits '80-'13 FLHR, FLHRC, FLHT, FLHTC, FLHTCU, FLHTK and FLT, '80-'93 FLHS and '09-'13 FLHTCUTG models.



E. V-LOGO FRONT FENDER RAIL

***WARNING:** Fender rails are decorative items only. Do not strap anything to the rails. Adding any additional weight to the front fender could adversely affect vehicle handling, causing loss of control and death or serious injury.

Notice: The prices appearing in this catalog are the manufacturer's suggested retail prices. Actual retail prices may vary.

F. V-LOGO REAR FENDER RAIL*

Designed with a similar styling theme to match our Touring V-Logo Front Fender Rail P/N 91099-94A. Replaces the stock rear fender rail and rubber bumper on Touring models. Chrome-plated twin tubes are crowned with a hand-polished and chrome-plated cast V-Logo reminiscent of the Harley-Davidson® 1953 Golden Anniversary medallion. Includes hardware and installation instructions.

91100-09 **\$107.95**
Fits '09-later FLHR, FLHRC, FLHRXS, FLHT, FLHTC, FLHTCU, FLHTCUL, FLHTK, FLHTKL, FLTR, FLTRK and FLTRU models. Does not fit with mud flaps.



F. V-LOGO REAR FENDER RAIL



G. FL TOURING CLEAN FRONT FENDER

TOURING & TRIKE 303

Headlamp & Fender Trim

G. FL TOURING CLEAN FRONT FENDER

With no holes, this fender provides the starting point for customization. Offered in primed finish and ready to bolt onto existing brackets.

59045-00B **\$559.95**
Fits '94-'13 FLHR and '89-'13 FLHT and FLT models.

H. VOLTAGE REGULATOR COVER – CHROME

This chrome-plated steel cover features an open-faced design to allow airflow through the voltage regulator. Chrome-plated mounting hardware included.

74538-09 **\$53.95**
Fits '09-'13 Touring (except models with oil coolers). Will not fit models equipped with a sidecar.

74543-00 **\$53.95**
Fits '97-'08 Electra Glide®, Road Glide® and Road King® (except models with oil coolers). Will not fit '07-later models equipped with a sidecar.



H. VOLTAGE REGULATOR COVER – CHROME ('09-'13 MODELS SHOWN)



I. TIE-DOWN BRACKETS – CHROME

I. TIE-DOWN BRACKETS – CHROME

Simplify the process of securing your bike to a trailer or bike lift. These stylish chrome Tie-Down Brackets mount cleanly to the front fork cover and offer a secure method to connect tie-down straps. Moving the tie-down point from the handlebar to the triple-tree area reduces wear on the handlebar bushings and ensures a consistent easy-to-access mounting point. Just add Harley-Davidson® Ratchet Straps and Soft Hooks and you're ready to go.

93500011 **\$83.95**
Fits '14-later Touring models (except Road Glide® and Road King®). Does not fit Trike models.

93500006 **\$83.95**
Fits '02-'17 FLS, FLSS, FLSTC, FLSTF, FLSTFB and FLSTFBS, '95-later FLHR, FLHRC and FLHRXS, '95-'13 FLHT, FLHTC and FLHX, '10-'13 FLHTCU and FLHTK, '10-'12 FLHXSE and '09-'12 FLHTCUSE, FLS, FLSS, FLSTF, FLSTFB and FLSTFBS models without a windshield require separate purchase of Hardware Kit P/N 91800030.

J. OUTER FAIRING SKIRT – GLOSS BLACK

Add a sinister touch to your batwing fairing. This classic gloss black skirt replaces the Original Equipment chrome or color-matched trim below the headlamp. The black skirt visually slims the fairing, and is the ideal finishing element on a blacked-out bike. Manufactured from Original Equipment components for superior fit and finish.

57100227 **\$71.95**
Fits '14-later Electra Glide®, Street Glide® and Ultra Limited models.

46559-03 **\$137.95**
Fits '00-'13 FLHT, FLHTC, FLHTCU, FLHTK and FLHX models. Does not fit Trike models.



J. OUTER FAIRING SKIRT – '14-LATER MODELS



J. OUTER FAIRING SKIRT – '00-'13 MODELS

K. ROAD GLIDE® FAIRING SUPPORT KIT – GLOSS BLACK

Take your Road Glide motorcycle in a different direction. Easy-to-install Fairing Mount replaces the Original Equipment chrome edition, and forms a seamless gloss black transition between a black engine guard and a dark color fairing. Kit includes gloss black left and right fairing support and matching engine guard clamps.

47200278 **\$186.95**
Fits '15-later Road Glide models.



K. ROAD GLIDE FAIRING SUPPORT KIT – GLOSS BLACK



Notice: The prices appearing in this catalog are the manufacturer's suggested retail prices. Actual retail prices may vary.

304 TOURING & TRIKE

Fender Trim

A. FRONT FENDER TRIM

Add a sweeping dash of chrome to the front fender. Chrome-plated tapered spear features a stepped design that accentuates the flowing fender lines. Self-adhesive backing simplifies installation.

14100618 **\$49.95**
Fits '12-'16 FLD, '86-'17 FL Softail® (except FLSTSB), '18-later Softail FLDE, FLHC and FLHCS, '84-later Touring and Trike models.

B. BAR & SHIELD LOGO FRONT FENDER SPEAR

This chrome-plated trim spear adds a sweeping dash of chrome to the front fender. Featuring a raised Bar & Shield logo set against a textured black field, this self-adhesive medallion is easy to install.

91195-04 Large. **\$48.95**
Fits '12-'16 FLD, '86-'17 FL Softail (except FLSTSB), '18-later Softail FLDE, FLHC and FLHCS, '84-later Touring and Trike models.

C. BAR & SHIELD FENDER TIP LENS KIT

Chrome-plated polycarbonate construction features translucent Bar & Shield emblems. The kit includes front and rear lenses. Front lens features an amber Bar & Shield, rear lens features a red Bar & Shield. Quick and easy installation.

59081-96 Front and Rear. **\$33.95**
Fits '86-'17 FLSTC, '93-'96 FLSTN and '80-'08 FLHR, FLHS, FLHT and FLT models. (Does not fit Springer™, FLHRS or FLTR models.)

D. FENDER TIP LENS KIT WITH SKULL LOGO

This chrome-plated Fender Tip Lens Kit adds a little attitude to your ride. The kit features front and rear lenses with a translucent illuminated skull silhouette. The easy-to-install kit includes an amber front lens and red rear lens.

59651-01 **\$33.95**
Fits '86-later FLSTC, '93-'96 FLSTN and '80-'08 Electra Glide®, Tour Glide™ and Road King® models (except FLHRC and FLHRS).

E. H-D® CLASSIC FENDER TIP

Stock on Road King Classic models, these nostalgic-look fender tips are also available for other models. Replaces fender lamp assembly.

59002-98 Front. **\$58.95**
Fits '80-'13 FL, '86-'08 FLSTC, '94-'13 FLHR and '09-'13 FLHTCUTG models.

59052-98 Rear. **\$35.95**
Fits '80-'08 FL and FLHR models and '86-'99 FLSTC models. (Does not fit FLSTF and FLTR models.)



A. FRONT FENDER TRIM KIT



B. BAR & SHIELD LOGO FRONT FENDER SPEAR



C. BAR & SHIELD FENDER TIP LENS



D. FENDER TIP LENS WITH SKULL LOGO



E. H-D CLASSIC FENDER TIP



E. H-D CLASSIC FENDER TIP



F. FRONT FENDER SKIRT - CHROME



F. FRONT FENDER SKIRT - GLOSS BLACK



G. FENDER SKIRT MEDALLIONS (BAR & SHIELD SHOWN)

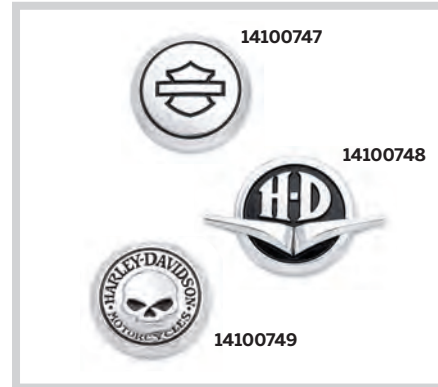

G. FENDER SKIRT MEDALLIONS



H. CONCHO FENDER SKIRT



I. WILLIE G SKULL FENDER SKIRT



J. BAR & SHIELD FENDER SKIRT



K. ROAD KING CLASSIC FENDER SKIRT

TOURING & TRIKE 305

Fender Trim

F. FRONT FENDER SKIRT

Designed as an easy-to-install replacement for the Original Equipment fender trim, this formed steel fender skirt features four raised accent ribs that wrap around the rear to add depth and texture. Available in your choice of mirror-finished chrome or gloss black finishes, the skirt is the perfect complement to any styling direction. And for a distinctive look, the flat side panels are the perfect spot to place your choice of self-adhesive medallions (sold separately). Kit includes mounting hardware.

Fits '14-later Touring and Tri Glide® models with Original Equipment fender skirts.

61400312 Chrome. **\$43.95**
61400311 Gloss Black. **\$43.95**

G. FENDER SKIRT MEDALLIONS

Personalize your fender skirts or almost any flat surface. These heavy-weight cast three-dimensional medallions add a distinctive look to your ride, and complement other available Harley® accessory collections. Self-adhesive backing holds the medallion firmly in place. Medallions are approximately 1.5" diameter. Sold in pairs.

14100747 Bar & Shield. **\$28.95**
14100748 Classic H-D. **\$28.95**
14100749 Willie G Skull. **\$28.95**

H. CONCHO FENDER SKIRT

This decorative fender skirt features conchos inspired by the Heritage Softail® Classic motorcycle.

59147-96 **\$64.95**
Fits '06 FLST, '86-'08 FLSTC, '93-'96 FLSTN, '80-'13 Touring and '09-'13 Trike models equipped with Original Equipment fender skirt.

I. WILLIE G SKULL FENDER SKIRT

This decorative chrome-plated fender skirt is a direct replacement for stock fender skirt. Features a three-dimensional sculptured concho with skull design set off with black accents. Mounting hardware included.

59582-02A **\$64.95**
Fits '06 FLST, '86-'08 FLSTC, '93-'96 FLSTN, '80-'13 Touring and '09-'13 Trike models equipped with Original Equipment fender skirt.

J. BAR & SHIELD FENDER SKIRT

This rigid-steel fender skirt, designed to replace the original factory-equipped aluminum trim, is formed, polished and chrome-plated. Its ribbed pattern offers a unique styling element and adds rigidity. Subtle but distinctive brushed aluminum Bar & Shield logos are framed by a stamped-in ribbed outline on both sides.

59228-91 **\$64.95**
Fits '06 FLST, '86-'08 FLSTC, '93-'96 FLSTN, '80-'13 Touring and '09-'13 Trike models equipped with Original Equipment fender skirt.

K. ROAD KING® CLASSIC FENDER SKIRT

The latest in the family of Road King-inspired accessories, this chrome-plated steel fender skirt features four raised accent ribs and a die-cast Road King® Classic medallion in chrome with black accents. Mounting hardware included.

59005-98 **\$64.95**
Fits '80-'13 Touring and '09-'13 Trike models equipped with Original Equipment fender skirt.

Notice: The prices appearing in this catalog are the manufacturer's suggested retail prices. Actual retail prices may vary.

Notice: The prices appearing in this catalog are the manufacturer's suggested retail prices. Actual retail prices may vary.

306 TOURING & TRIKE

Fairing Trim

A. GAUGE TRIM KIT – CHROME

A touch of chrome makes all the difference. These classic gauge bezels take just a few minutes to install, and add the beauty of chrome to your dash. Trim rings are formed to the gauge shapes and feature peel-and-stick adhesive backing for permanent installation. No back plate is required for installation. The 4-piece kit includes two large and two small gauge bezels.

61400451 **\$95.95**
Fits '14-later Electra Glide®, Street Glide® model, Ultra Limited and Tri Glide® models. Fits with '18-later CVO™ model backplate. Does not fit with Gauge Trim P/N 61400328.



A. GAUGE TRIM KIT – CHROME



B. RADIO TRIM BEZEL

B. RADIO TRIM BEZEL

This chrome faceplate trim accents the center section of the inner fairing and highlights the radio. Trim is formed to the radio surround and features peel-and-stick adhesive backing for simple, permanent installation.

61400201 **\$31.95**
Fits '14-later Electra Glide, Street Glide, Ultra Limited and Tri Glide® models.

C. INNER FAIRING TRIM KIT

Add a touch of luxury and style to your dash. This complete kit dresses the inner fairing by surrounding the radio faceplate and gauges with chrome. Package includes Bar & Shield Radio Faceplate, two 4.0" Speedo/Tach Gauge Bezels, four 2.0" Gauge Bezels, Radio and Gauge Faceplate Trim and two Front Speaker Trim Rings.

96396-09 **\$129.95**
Fits '06-'13 Electra Glide, Street Glide and Trike models equipped with the Advanced Audio System Radio.

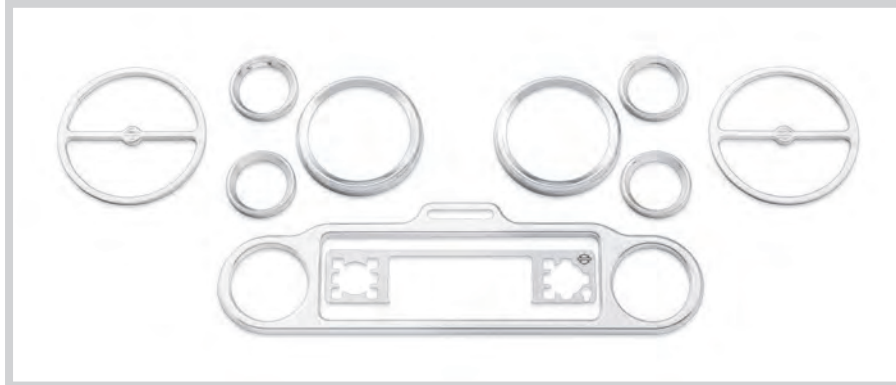

C. INNER FAIRING TRIM KIT

D. CHROME INSTRUMENT BEZELS

A touch of chrome makes all the difference. These bezel covers take just seconds to install and add the beauty of chrome to your dash. Available to fit all the fairing-mount gauges, these easy-to-install, chrome-plated formed rings feature peel-and-stick adhesive backing for permanent installation.

1. 4" Chrome Gauge Bezel

74541-00 **\$20.95**
Fits Speedometer and Tachometer Gauges on '00-'22 XL, '00-'13 Dyna® (except FLD and FXDWG), '13-'17 FXSB, FXSBSE, and FXST-Aus, and '00-'13 Electra Glide, Street Glide, Road Glide® and Trike Models. Sold individually.

2. 2" Chrome Gauge Bezel

74550-92T **\$22.95**
Fits Voltmeter, Oil Pressure, Air Temp and Fuel Gauge on '86-'13 Electra Glide, Street Glide, Road Glide and Trike models. Sold in pairs.

3. Chrome Indicator Lamp Bezel Cover

74562-98 **\$20.95**
Fits '96-'13 Electra Glide, Street Glide and Trike models.

4. Radio and Gauge Faceplate Trim

74612-06 **\$32.95**
Fits '96-'13 Electra Glide, Street Glide and Trike models.

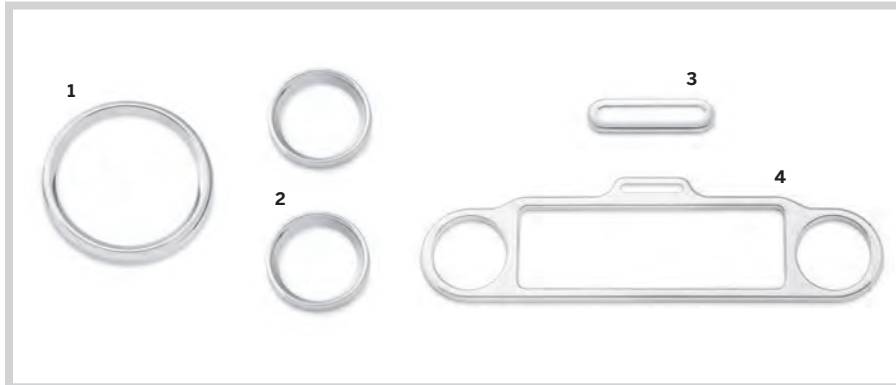

D. CHROME INSTRUMENT BEZELS

E. INNER FAIRING TRIM KIT – ROAD GLIDE®

Add a touch of luxury and style to your dash. This complete kit dresses the inner fairing by surrounding the gauges, radio faceplate and front speakers with chrome. Self-adhesive bezels are easy to install, and add a brilliant finish to matte or gloss finish inner fairings. The 6-piece kit includes the Gauge Trim Kit, Radio Faceplate Trim and two Front Speaker Trim Rings.

61400296 **\$160.95** 6-Piece Kit.
Fits '15-later Road Glide® models (except FLTRUSE). Also fits '23-later FLTRT models. Does not fit models equipped with Boom!™ Audio Fairing Speakers.

F. RADIO TRIM BEZEL – ROAD GLIDE

This chrome faceplate trim accents the center section of the inner fairing and highlights the radio. Trim is formed to the radio surround and feature peel-and-stick adhesive backing for simple, permanent installation.

61400298 **\$43.95**
Fits '15-later Road Glide models. Also fits '23-later FLTRT models.



E. INNER FAIRING TRIM KIT – ROAD GLIDE



F. RADIO TRIM BEZEL – ROAD GLIDE



G. INNER FAIRING TRIM – CARBON FIBER DESIGN



Gauge Trim

5-Piece Trim



H. GAUGE BEZEL KIT – GLOSS BLACK

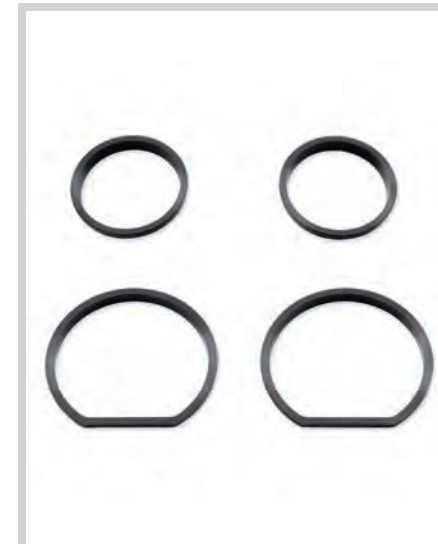

I. BOOM! AUDIO STAGE I SPEAKER TRIM – FRONT, '14-LATER MODELS



I. BOOM! AUDIO STAGE I SPEAKER TRIM – REAR, '14-LATER MODELS

TOURING & TRIKE 307

Fairing Trim

G. INNER FAIRING TRIM – CARBON FIBER DESIGN

Transform the look of the inner fairing with this easy-to-install fairing trim accents. These self-adhesive components add a contrasting look to the expanse of satin black or color-matched surface in front of you. The 5-piece kit includes media storage door trim, left panel trim and 3-piece switch panel trim. The Gauge Trim surrounds the instrument cluster for added depth and dimension.

Fits '14-later Electra Glide®, Street Glide®, Ultra Limited and Tri Glide® models.

61400328 Gauge Trim. **\$78.95**

61400334 5-Piece Trim. **\$134.95**

H. GAUGE BEZEL KIT – GLOSS BLACK

Complete the custom look of the inner fairing. These aluminum Gauge Bezels feature a rich gloss black surface, and are machined to cover the bright bezel that surrounds the Original Equipment gauges. The easy-to-install gauge bezel kit includes Speedometer and Tachometer bezels and auxiliary gauge bezels.

61400399 4-Bezel Kit. **\$213.95**

Fits '14-later Electra Glide, Street Glide, Ultra Limited, Road Glide® and Tri Glide models. Also fits '23-later FLTRT models.

I. BOOM!™ AUDIO STAGE I SPEAKER TRIM

Add a touch of chrome to your Boom! Audio Speakers. Chrome trim rings outline the speaker and accent the rich black speaker grill. Easy to install, the trim rings complement available chrome fairing trim. Sold in pairs.

61400193 Front. **\$48.95**

Fits '21 Electra Glide, Street Glide, Ultra Limited and Tri Glide models with Boom!™ Audio Stage I Fairing Mount Speakers.

61400210 Rear. **\$48.95**

Fits '21 Electra Glide®, Street Glide®, Ultra Limited™, Road Glide®, Ultra and Tri Glide models with Rear Speaker Pods and Boom!™ Audio Stage I Tour-Pak® Rear Speakers.

Notice: The prices appearing in this catalog are the manufacturer's suggested retail prices. Actual retail prices may vary.

Notice: The prices appearing in this catalog are the manufacturer's suggested retail prices. Actual retail prices may vary.

308 TOURING & TRIKE

Fairing Trim

A. SPEAKER TRIM – CHROME

When it comes to style, this chrome-plated trim makes your speakers look as good as they sound. These bezels mount directly over the Original Equipment speaker grills, and add a subtle spot of chrome. Easy to install, the kit includes left and right speaker trim and required mounting supplies.

61400197 Front. **\$43.95**
Fits '14-later Electra Glide®, Street Glide®, Ultra Limited and Tri Glide® models with Original Equipment speakers. Does not fit FLHTKSE models or models equipped with Boom!™ Audio High Performance Speakers or Harley-Davidson® Audio Powered by Rockford Fosgate®.

61400194 Rear. **\$43.95**
Fits '14-later FLHTCU, FLHTCUL, FLHTK, FLHTKL, FLTRU and FLHTCUTG models with Original Equipment Tour-Pak® speakers. Does not fit FLHTKSE, FLTRUSE or models equipped with Boom!™ Audio High Performance Speakers or Harley-Davidson® Audio Powered by Rockford Fosgate®.

74604-99 Front. **\$37.95**
Fits '96-'13 Electra Glide, Street Glide and Trike models with Original Equipment Speaker Grills. Does not fit '11-'13 FLHXSE, '12-'13 FLHTCUSE or models equipped with Boom! Audio High Performance Speakers.

74584-99 Rear. **\$39.95**
Fits '98-'13 FLHTCU, FLHTK and FLHTCUTG models. Does not fit '12-'13 FLHTCUSE or models equipped with Boom! Audio High Performance Speakers.



A. SPEAKER TRIM – FRONT '14-LATER MODELS



A. SPEAKER TRIM – REAR '14-LATER MODELS



A. SPEAKER TRIM – FRONT '96-'13 MODELS



A. SPEAKER TRIM – REAR '98-'13 MODELS

B. FAIRING MOUNT MIRRORS – BLACK

Fairing Mount Mirrors offer a truly innovative look from the traditional handlebar-mounted mirrors. Mounting just inside the inner fairing, the molded plastic mirror housings complement the contours of the batwing fairing. They provide a wide range of adjustability and feature convex mirror glass that maximizes your field of view. The Bar & Shield logo is carefully laser-etched on each mirror glass. Kit includes necessary hardware, instructions and mounting template for easy installation.

56000076 **\$108.95**
Fits '14-later Electra Glide, Ultra Limited and Tri Glide models. Original Equipment on Street Glide models (except FLHTCUTG).

91945-98B **\$108.95**
Fits '96-'13 Electra Glide and Trike models. Original equipment on Street Glide models.

C. FAIRING MOUNT MIRRORS – CHROME

Add a splash of chrome to the batwing inner fairing. These Fairing Mount Mirrors de-clutter the handlebar and add a contemporary aero style to your ride. The attractive chrome housing provides a custom look, and the convex mirror and wide range of adjustment maximizes your field of view. A direct bolt-on replacement for Original Equipment fairing mount mirrors, the kit includes the hardware and mounting template required for easy and accurate installation on many models.

56000077 **\$146.95**
Fits '14-later Electra Glide, Street Glide, Ultra Limited and Tri Glide models. Original Equipment on Street Glide models (except FLHTCUTG).

56000029 **\$146.95**
Fits '96-'13 Electra Glide, Street Glide and Trike models. Original Equipment on '12 FLHXSE models.



B. FAIRING MOUNT MIRRORS – BLACK



C. FAIRING MOUNT MIRRORS – CHROME

D. ILLUMINATED FAIRING MOUNT MIRROR COVERS – CHROME

Add auxiliary LED turn signals and a splash of chrome to the inner fairing. The perfect finishing touch to a fully dressed inner fairing, these chrome-plated mirror housings feature fast-acting amber LED turn signals at the outer edge. Side turn signals attract attention from the drivers around you, and the plug-in, no-splice design simplifies installation.

56000084 **\$163.95**
Fits '14-later Touring and Trike models with fairing-mount mirrors. Does not fit with Split Vision Fairing Mount Mirrors P/N 92085-10 or Tapered Fairing Mount Mirrors P/N 56000098A or 56000099A.



D. ILLUMINATED FAIRING MOUNT MIRROR COVERS – CHROME



E. SWITCH PANEL ACCENT

TOURING & TRIKE 309

Fairing Trim

E. SWITCH PANEL ACCENT

Dress for success. This handsome trim element frames the ignition and flanking rocker switches in chrome. Simple to install with peel-and-stick adhesive, the kit also includes inserts to cover inactive switch openings. Complete the chrome look with optional Radio Trim P/N 74612-06 and Chrome Gauge Bezels.

61400001 **\$59.95**
Fits '96-'13 Electra Glide®, Street Glide® and Trike models.

F. FORK LOCK COVER

This chrome-plated aluminum die-cast cover finishes the look of the Road King® fork lock. The protective cover adds a finishing touch to the handlebar cover and the smooth domed lid flips up to provide access to the fork lock. Includes chrome-plated flush-mount hardware.

71790-05 Fits '94-later Road King® models. **\$54.95**

G. BULLSEYE CONSOLE NUT

Replace your plain stock chrome acorn nut with this special chrome-plated Console Nut that features a machined Bullseye design highlighted with black accent rings.

94755-99 **\$8.95**
Fits '93-'03 FXDWG, '90-'95 and '00-'17 Softail® (except FLSTSB, FXCW, FXCWC, FXS, FXSB, FXSBSE, FXSE, FXST-AUS, FXSTD and '09-'17 FLS, FLSS and FLSTC) and '94-'07 Road King models.

H. GAUGE VISOR RING

A touch of chrome makes all the difference. These easy-to-install trim rings feature an integrated eyebrow visor to shield the gauge face from the sun's glare. Self-adhesive backing for secure mount.

74661-04 5" Gauge. **\$42.95**
Fits '12-'17 FLD, '99-'08 FXDWG, '15-'17 FXDF, '99-'17 Softail (except FLSTFSE, FLSTNSE, FXCW, FXCWC, FXS, FXSB, FXSBSE, FXSE, FXST-AUS, FXSTD and models equipped with Chrome Console P/N 67575-04), '18-later FLSSL, FLDE, FLHC and FLHCS and '99-'07 Road King models.



F. FORK LOCK COVER – CLOSED



F. FORK LOCK COVER – OPEN



G. BULLSEYE CONSOLE NUT



H. GAUGE VISOR RING

Notice: The prices appearing in this catalog are the manufacturer's suggested retail prices. Actual retail prices may vary.

Notice: The prices appearing in this catalog are the manufacturer's suggested retail prices. Actual retail prices may vary.

310 TOURING & TRIKE

Console Trim

A. GLOSS BLACK CONSOLE KIT

Lead the way to the dark side. This blacked-out Console Kit includes the major components required to change the chrome console to a dark custom look. Manufactured from Original Equipment components for superior fit and finish, the kit includes black console, gasket and hardware. Available for models with or without 7-pin DIN headset connector. Add your choice of Fuel Door (sold separately) to set your bike apart from the crowd.

Fits '08-later Electra Glide®, Street Glide®, Ultra Limited, Road Glide® and Tri Glide® models with center fill tank.

70900463	Without CB Communications Port.	\$319.95
70900501	With CB Communications Port.	\$319.95

B. FUEL TANK CONSOLE DOOR – GLOSS BLACK

The gloss black fuel door is the perfect match for the Gloss Black Console Kit. The easy-to-install fuel door replaces the stock door, and reuses Original Equipment mounting hardware.

70900465A		\$68.95
Fits '08-later Electra Glide, Street Glide, Ultra Limited, Road Glide and Tri Glide models with center fill tank.		

C. PUSH-BUTTON FUEL TANK CONSOLE DOOR RELEASE

An added convenience you'll appreciate at fuel stops. This lockable replacement for your stock fuel tank console door lock allows the door to be opened without a key by depressing the center button of the lock. For basic security, it can be locked with any barrel key.

53842-00C		\$33.95
Fits '92-later Electra Glide, Street Glide, Ultra Limited, Tour Glide™, Road Glide and Tri Glide models with center fill tank.		

D. SMOOTH PUSH-BUTTON FUEL TANK CONSOLE DOOR RELEASE

Add stop-and-go speed at the gas pump. The smooth button replaces the lock for push-to-open convenience. No more digging in your pocket for the key. The large button is easy to operate while wearing gloves.

Fits '92-later Electra Glide, Street Glide, Ultra Limited, Tour Glide, Road Glide and Tri Glide models with center fill tank.

53919-04B	Chrome.	\$33.95
90300096A	Gloss Black.	\$33.95



A. GLOSS BLACK CONSOLE KIT (70900463 SHOWN) (SHOWN WITH BLACK FUEL DOOR)



A. GLOSS BLACK CONSOLE KIT (70900501 SHOWN) (SHOWN WITH BLACK FUEL DOOR)



B. FUEL TANK CONSOLE DOOR – GLOSS BLACK



C. PUSH-BUTTON FUEL TANK CONSOLE DOOR RELEASE



D. SMOOTH PUSH-BUTTON FUEL TANK CONSOLE DOOR RELEASE – GLOSS BLACK



D. SMOOTH PUSH-BUTTON FUEL TANK CONSOLE DOOR RELEASE – CHROME



E. NUMBER ONE SKULL FUEL TANK CONSOLE DOOR



F. RIDE FREE FUEL TANK CONSOLE DOOR



G. WILLIE G SKULL FUEL TANK CONSOLE DOOR – BLACK



H. WILLIE G SKULL FUEL TANK CONSOLE DOOR – CHROME



I. LIVE TO RIDE FUEL TANK CONSOLE DOOR – CHROME



I. LIVE TO RIDE FUEL TANK CONSOLE DOOR – GOLD

TOURING & TRIKE 311

Console Trim

E. NUMBER ONE SKULL FUEL TANK CONSOLE DOOR

The sinister Harley-Davidson #1 Skull logo dresses for a night on the town. This complete die-cast aluminum collection has been polished and chrome-plated to a brilliant shine, then finished with a contrasting black-filled Dark Custom Skull logo. These easy-to-install Fuel Doors replace the stock door, and reuse Original Equipment mounting hardware and lock.

62378-10A		\$43.95
Fits '08-later Electra Glide®, Street Glide®, Ultra Limited, Road Glide® and Tri Glide® models with center fill tank.		

F. RIDE FREE™ COLLECTION FUEL TANK CONSOLE DOOR

This collection celebrates our liberty to enjoy the freedom of the open road, and calls us all to explore, discover and unite with our love of motorcycling. Inspired by Willie G. Davidson's famous phrase, this collection continues in that tradition. Easy install in 30 minutes or less with no special tools needed. Reuses the Original Equipment mounting hardware and lock.

70900843		\$48.95
Fits '08-later Electra Glide, Street Glide, Ultra Limited, Road Glide and Tri Glide models with center fill tank.		

G. WILLIE G SKULL COLLECTION FUEL TANK CONSOLE DOOR – BLACK

Penned at the hand of Willie G, the famous Skull Collection makes a shift to the dark side. Completely drenched in matte black, the raised skull and surrounding Harley-Davidson Motorcycle script adds a subtle ominous touch to your ride. The matte finish easily coexists alongside gloss black or wrinkle black surfaces. These easy-to-install Fuel Doors replace the stock door, and reuse Original Equipment mounting hardware and lock.

61300794		\$43.95
Fits '08-later Electra Glide, Street Glide, Ultra Limited, Road Glide and Tri Glide models with center fill tank.		

H. WILLIE G SKULL FUEL TANK CONSOLE DOOR – CHROME

Add a little attitude to your ride. Styled to complement Harley-Davidson® Skull accessory items, the menacing raised skull with black-filled eyes leaps from a field of chrome. The surrounding Harley-Davidson Motorcycles script is the perfect finishing touch. These easy-to-install Fuel Doors replace the stock door, and reuse Original Equipment mounting hardware and lock.

61308-09A		\$43.95
Fits '08-later Electra Glide, Street Glide, Ultra Limited, Road Glide and Tri Glide models with center fill tank.		

61374-04		\$43.95
Fits '92-'07 Electra Glide, Tour Glide™ and Road Glide models with center fill tank.		

I. LIVE TO RIDE FUEL TANK CONSOLE DOOR

Live to Ride, Ride to Live. It has become the motto of the Harley-Davidson nation, accompanying riders over millions of miles of travel. This collection is a tribute to that way of life. These easy-to-install Fuel Doors replace the stock door, and reuse Original Equipment mounting hardware and lock. Available in your choice of gold or chrome finish.

Fits '08-later Electra Glide, Street Glide, Ultra Limited, Road Glide and Tri Glide models with center fill tank.

61335-09A	Gold.	\$43.95
61300049A	Chrome.	\$43.95

Fits '92-'07 Electra Glide, Tour Glide and Road Glide models with center fill tank.

61286-92T	Gold.	\$43.95
------------------	-------	----------------

Notice: The prices appearing in this catalog are the manufacturer's suggested retail prices. Actual retail prices may vary.

Notice: The prices appearing in this catalog are the manufacturer's suggested retail prices. Actual retail prices may vary.

312 TOURING & TRIKE

Tour-Pak® Trim

A. TOUR-PAK® HINGE AND LATCH KIT – GLOSS BLACK

Upgrade the appearance of your Tour-Pak® luggage. These Original Equipment-style hinges and latch are polished and finished in rich gloss black. The complete kit includes hinges, latch and all necessary hardware.

53000343 **\$213.95**

Fits '14-later Touring and Tri Glide® models equipped with Chopped or King Tour-Pak Luggage.

B. PREMIUM TOUR-PAK LATCHES

Styled to complement the Premium Tour-Pak Hinges, these die-cast latches provide a bold look to your ride. Designed to eliminate the traditional catch and clamp design, these latches make access to the Tour-Pak luggage easier than ever. Simply press down on the top of the lid to secure the latching mechanism. The self-aligning design positions the lid perfectly for no-fuss closure. A simple push of the button releases the lock and pops the lid open for convenience. Latches feature hidden hardware for a clean appearance and the front latch wraps around the Original Equipment lock for a custom touch. Kit includes front and rear latch and all mounting hardware.

Fits '06-'13 Touring and Trike models equipped with King or Ultra Tour-Pak Luggage. Does not fit with Leather, Razor-Pak or Chopped Tour-Pak Luggage. Does not fit models equipped with Tour-Pak Lock Covers P/N 53000217 or 53000218.

53000252 Chrome. **\$118.95**

53000253 Gloss Black. **\$118.95**

C. PREMIUM TOUR-PAK HINGES

Upgrade the appearance of your Tour-Pak luggage with billet-style premium hinges. Styled to complement the Original Equipment Tour-Pak latches, these hinges add a clean, bold look with no exposed hardware. Available in mirror chrome or gloss black finish, the complete kit includes two hinges and all necessary hardware. Drill is required to remove the factory installed hinge mounting rivets.

Fits '88-'13 Touring and Trike models equipped with Razor-Pak, Chopped or King Tour Pak luggage.

79211-08A Chrome. **\$57.95**

53000131 Gloss Black. **\$57.95**

D. TOUR-PAK® REAR LIGHT TRIM

Add a custom touch to the Original Equipment Tour-Pak® carrier's rear lighting. This mirror chrome trim covers the satin black surface and adds a brilliant finishing touch to the rear of the bike. Self-adhesive mounting simplifies installation.

53000329 **\$89.95**

Fits '14-later FLHT, FLHTCU, FLHTCUL, FLHTK, FLHTKL, FLTRK, FLTRU, FLHTCUTG and models equipped with accessory King Tour-Pak and LED wrap-around tail lamp. Does not fit with Accent Rail P/N 53000229.

E. TOUR-PAK SIDE MARKER LIGHT TRIM

Add a custom touch to the Original Equipment Tour-Pak carrier's side lighting. Mirror chrome trim surrounds the side marker lights for a bit of flash and the self-adhesive backing simplifies installation. Kit includes left and right side trim.

53000330 **\$89.95**

Fits '14-later FLHTCU, FLHTCUL, FLHTK, FLHTKL, FLTRK, FLTRU and FLHTCUTG models with Original Equipment King Tour-Pak-mounted side lights. Also fits '14-later models equipped with accessory King Tour-Pak and Side Marker Light Kits P/N 54352-09 or 69494-06.



A. TOUR-PAK HINGE AND LATCH KIT – GLOSS BLACK



B. PREMIUM TOUR-PAK LATCHES – GLOSS BLACK



B. PREMIUM TOUR-PAK LATCHES – CHROME



C. PREMIUM TOUR-PAK HINGES – GLOSS BLACK



C. PREMIUM TOUR-PAK HINGES – CHROME



E. TOUR-PAK SIDE MARKER LIGHT TRIM



D. TOUR-PAK REAR LIGHT TRIM



F. TOUR-PAK LATCHES – GLOSS BLACK



G. EZ TOUR-PAK LID CATCH



H. TOUR-PAK LOCK COVER – CHROME



H. TOUR-PAK LOCK COVER – GLOSS BLACK



I. RETRACTABLE TOUR-PAK LID TETHER



J. RETRACTABLE TRUNK DOOR TETHER

TOURING & TRIKE 313

Tour-Pak® Trim

F. TOUR-PAK® LATCHES – GLOSS BLACK

Add a custom touch to your Tour-Pak® luggage. Styled to complement available gloss black Premium Tour-Pak Hinges, these Original Equipment-style latches are polished and finished in rich gloss black. The complete kit includes latches, hasps and all necessary hardware.

53000130 **\$47.95**

Fits '88-'13 Touring and Trike models equipped with Razor-Pak, Chopped or King Tour-Pak Luggage.

G. EZ TOUR-PAK LID CATCH

Add the convenience of a self-aligning Tour-Pak lid to your Touring bike. Simply close the lid and latch it down. This easy-to-install kit eliminates the need to shift the position of the lid because the latches line up perfectly every time.

53000195 **\$18.95**

Fits '85-'13 Touring and Trike models equipped with King, Ultra or Razor-Pak Tour-Pak Luggage. Does not fit Chopped, Leather or Sport Tour-Pak luggage.

H. TOUR-PAK LOCK COVER

This elegant die-cast cover with a Bar & Shield logo adds a custom touch to your Tour-Pak lock. Simply use your thumb to rotate the domed cover to expose the Original Equipment lock. A detent holds the cover in the open position and provides unhindered access for your key. Easy to install, the protective cover is held firmly in place by the Original Equipment lock and lock mounting hardware.

Fits '88-'13 Touring and Trike models equipped with King, Razor-Pak or Chopped Tour-Pak Luggage. Does not fit with Premium Tour-Pak Latches P/N 53000252 or 53000253.

53000217 Chrome. **\$36.95**

53000218 Gloss Black. **\$36.95**

I. RETRACTABLE TOUR-PAK LID TETHER

Add the convenience of a Retractable Tether to your Tour-Pak luggage. When extended to its full length, the strong cord holds the lid open at least 10° past vertical for improved stability and easy packing. Then the device automatically coils the tether cord inside the housing to eliminate pinched cords when closing the lid. The attractive housing with Bar & Shield logo attaches to the existing mounting points and replaces the Original Equipment cord.

54171-11 **\$35.95**

Fits '97-'13 Touring and Trike models equipped with a King, Ultra, Chopped or Razor-Pak Tour-Pak luggage. Will not fit Leather or Sport Tour-Pak luggage.

J. RETRACTABLE TRUNK DOOR TETHER

Add the convenience of a Retractable Tether to your Trike trunk door. The tethers easily mount to your trunk door and replace the stock support cords. When you open the trunk door, the tether smoothly deploys from the housing to support the door in the full open position. Then as you close the door, the device automatically coils the tether cord inside the housing to eliminate pinched cords. The attractive housing with Bar & Shield logo attaches to the existing mounting points. Sold in pairs.

53000237 **\$66.95**

Fits '11-later Tri Glide® models.

Notice: The prices appearing in this catalog are the manufacturer's suggested retail prices. Actual retail prices may vary.

Notice: The prices appearing in this catalog are the manufacturer's suggested retail prices. Actual retail prices may vary.

314 TOURING & TRIKE

Saddlebag Trim

A. SADDLEBAG LATCH AND HINGE KIT – GLOSS BLACK

Gloss Black Saddlebag Hinge Covers and finger-operated Latches are an easy way to give your Touring bike a unique monochrome look. These latches add a dark custom touch to the motorcycles's profile, and complement almost any paint combination. Easy to install with Original Equipment hardware and reflectors.

90200914 Latch Lever and Hinge Cover Kit. **\$206.95**
Fits '14-later Touring models (except FLHXSE and FLTRXSE) equipped with hard saddlebags.

90201052 Latch Lever only. **\$79.95**
Fits '14-later Touring models (except FLHXSE and FLTRXSE) equipped with hard saddlebags.



A. SADDLEBAG LATCH AND HINGE KIT – GLOSS BLACK

B. SADDLEBAG LATCH PLATE – VIVID BLACK

Saddlebag Latch Plates are an easy way to give your Touring bike a unique monochrome look. Available in Vivid Black, these latches add a splash of color to the motorcycle profile. Easy to install with Original Equipment hardware.

Fits '93-'13 Touring models equipped with Color-Matched Hard Saddlebags. HDI models require separate purchase of Reflectors P/N 59289-92 and 59290-92.

90853-06DH Right Side. **\$68.95**

90857-06DH Left Side. **\$68.95**



A. SADDLEBAG LATCH AND HINGE KIT – GLOSS BLACK

C. BILLET SADDLEBAG HINGE COVER KIT – EDGE CUT

Dress your saddlebags in style. Edge Cut Saddlebag Hinge Covers feature a rich black finish that is machined to expose the highlights of raw aluminum. The contrasting cut-back look makes a powerful visual statement, and works great with both traditional and contemporary customizing styles. These covers replace the Original Equipment covers, but retain the stock hinges and locks for easy installation. Kit includes left and right covers, mounting hardware and saddlebag-mounted red reflectors.

90200915 **\$170.95**

Fits '14-later Touring (except FLHRC) models equipped with hard saddlebags. HDI models require separate purchase of amber Reflector P/N 59289-92 and 59290-92.



C. BILLET SADDLEBAG HINGE COVER KIT – EDGE CUT

D. BILLET SADDLEBAG HINGE COVER KIT – CHROME GROOVED

This sweep of chrome will set the tone for a very special Touring custom. Manufactured from billet aluminum, this polished and plated cover replaces the Original Equipment saddlebag hinge for a striking look. The grooved ball-milled design and curved leading and trailing edge add a feeling of forward motion, even while parked on Main Street. Kit includes chrome-plated mounting hardware and red saddlebag-mounted reflectors.

90201084 **\$170.95**

Fits '14-later Touring (except FLHRC) models equipped with hard saddlebags. HDI models require separate purchase of amber Reflector P/N 59289-92 and 59290-92.



A. SADDLEBAG LATCH AND HINGE KIT – GLOSS BLACK



B. SADDLEBAG LATCH PLATE – VIVID BLACK



D. BILLET SADDLEBAG HINGE COVER KIT – CHROME GROOVED



E. FENDER SUPPORT KIT – GLOSS BLACK



E. FENDER SUPPORT KIT – GLOSS BLACK



F. FENDER STRUT COVERS – GLOSS BLACK



G. SADDLEBAG FILLER STRIPS – BLACK



G. SADDLEBAG FILLER STRIPS – BLACK



G. SADDLEBAG FILLER STRIPS – CHROME, SLOTTED '95-'08 MODELS



H. LOWER BELT GUARD COVER – CHROME

TOURING & TRIKE 315

Chassis Trim – Rear End

E. FENDER SUPPORT KIT – GLOSS BLACK

Manufactured from Original Equipment components to ensure superior fit and finish, the gloss black Fender Support Kit replaces the Original Equipment cast and chrome fender support system and continues the dark look to the area between and behind the saddlebags. The ideal finishing touch for your blacked-out Touring bike, these covers are the perfect complement to the optional gloss black Passenger Sissy Bars, Luggage Racks, Tour-Pak® mounting racks and Docking Hardware Kits. Kit includes gloss black left and right supports and docking hardware slot fillers.

90201206 **\$330.95**

Fits '14-later Touring models.

F. FENDER STRUT COVERS – GLOSS BLACK

Manufactured from Original Equipment components to ensure superior fit and finish, the gloss black Fender Strut Covers conceal the cast fender struts and continue the dark look to the area behind the saddlebags. The ideal finishing touch for your blacked-out Touring bike, these covers are the perfect complement to the optional gloss black Passenger Sissy Bars, Stealth Luggage Rack and Docking Hardware Kits.

47498-09 **\$118.95**

Fits '09-'13 Touring models (except models equipped with rigid-mounted Tour-Pak luggage).

G. SADDLEBAG FILLER STRIPS

For those who seek perfection, these kits fill in the gaps between the fender and the rear of the saddlebags, hiding the saddlebag mounting bracket. Choose between primed, highly polished chrome, or color-matched to your sheet metal and bags for a truly custom look.

Fits '14-later Touring (except FLHRXS, FLHX, FLHXS, FLTRX, FLHXSE, FLTRXS and FLTRXSE) models with hard saddlebags. Does not fit with accessory Saddlebag Guard Rails.

90200872DH Solid – Vivid Black. **\$336.95**

Fits '95-'08 Electra Glide® (except FLHX), '94-'08 Road King® (except FLHRS and FLHRSE) and '93 FLHS models equipped with Nostalgic Saddlebag Guard Rails P/N 90839-94. Also fits '98 FLHRCI with Nostalgic Saddlebag Guard Rails P/N 91265-98. (Will not fit models equipped with Leather Saddlebags P/N 90652-94A, 90843-93 or Fender Rail P/N 91019-92A. Will not fit '98-'08 FLHRCI with H-D® Detachables™ Docking Kit or '98-'08 FLTR.)

45896-98 Slotted – Chrome. **\$146.95**

H. LOWER BELT GUARD COVER – CHROME

Dress your lower belt guard in chrome. This polished and chrome-plated metal guard is formed to fit over the Original Equipment belt guard for easy installation.

60408-09 **\$89.95**

Fits '07-later Touring models.

Notice: The prices appearing in this catalog are the manufacturer's suggested retail prices. Actual retail prices may vary.

Notice: The prices appearing in this catalog are the manufacturer's suggested retail prices. Actual retail prices may vary.

316 TOURING & TRIKE

Tour-Pak® & Saddlebag Lighting

SIGNATURE LED REAR LIGHTING

Signature LED Rear Lighting delivers modern style and function that improves rider conspicuity to surrounding traffic. The light pipe around the perimeter diffuses light and is always illuminated as a running light for eye-catching visibility. LED Brake and Turn lights exceed the output of Original Equipment rear lighting. These lamps offer easy plug-and-play installation that requires no wiring splicing.

A. SIGNATURE LED SADDLEBAG RUN/BRAKE/TURN LAMP

Add functional lighting to the rear of your Touring bike with these run/brake/turn lights. Lamps may act as a supplement to the Tour-Pak® luggage carrier mounted rear lighting, and also permit the removal of the Tour-Pak® luggage carrier with a Detachable Mounting Kit.

Fits '14-later Touring models equipped with standard or stretched saddlebags.

67801023	Red Lens.	\$266.95
67801024	Smoked Lens.	\$266.95

B. KEYSTONE LED RUN/BRAKE/TURN LAMP

Nestled in the fender strut opening, these Keystone LED lamps add stylish and practical lighting to the rear of the bike. When the bike is parked, the dark lamps fill the gap between the fender and saddlebags for a clean, uncluttered look. Lamps are mounted in a sealed housing that slips into the opening and are held in place with the saddlebag support hardware and an adhesive pad.

Fits '14-later FLHR, FLHTCU, FLHTCUL, FLHTK, FLHTKL, and FLTRU models.

67801080	Red Lens.	\$319.95
67801082	Smoked Lens.	\$319.95



A. SIGNATURE LED SADDLEBAG RUN/BRAKE/TURN LAMP



B. KEYSTONE LED RUN/BRAKE/TURN LAMP - RED LENS



B. KEYSTONE LED RUN/BRAKE/TURN LAMP



!WARNING: Disconnecting your DOT-required tail, brake and turn signal lighting could reduce your visibility to others and result in death or serious injury.

Notice: The prices appearing in this catalog are the manufacturer's suggested retail prices. Actual retail prices may vary.

TOURING & TRIKE 317

Tour-Pak® & Saddlebag Lighting

C. SIGNATURE LED KING TOUR-PAK® LUGGAGE CARRIER RUN/BRAKE/TURN LAMP KIT

Sequential turn signal elements sweep outward from the center to grab the attention of other motorists and make the motorcycle more conspicuous. Offered with Smoked or Red lenses.

Fits '14-later Touring and Trike models equipped with King Tour-Pak® luggage carrier.

67801129	Red Lens.	\$372.95
67801128	Smoked Lens.	\$372.95

D. SIGNATURE LED TOUR-PAK SIDE MARKER LIGHT KIT

Replaces Original Equipment King Tour-Pak side marker lights with brilliant LED elements to complement LED Signature lighting to the rear of the motorcycle. Offered with Smoked or Red lenses.

Fits '14-later Touring and Trike models equipped with King Tour-Pak® luggage carrier.

68000312	Smoked Lens.	\$180.95
68000313	Red Lens.	\$180.95



C. SIGNATURE LED KING TOUR-PAK® LUGGAGE CARRIER RUN/BRAKE/TURN LAMP KIT - RED LENS



C. SIGNATURE LED KING TOUR-PAK® LUGGAGE CARRIER RUN/BRAKE/TURN LAMP KIT - SMOKED LENS



D. SIGNATURE LED TOUR-PAK SIDE MARKER LIGHT KIT - RED LENS



D. SIGNATURE LED TOUR-PAK SIDE MARKER LIGHT KIT - SMOKED LENS

!WARNING: Disconnecting your DOT-required tail, brake and turn signal lighting could reduce your visibility to others and result in death or serious injury.

Notice: The prices appearing in this catalog are the manufacturer's suggested retail prices. Actual retail prices may vary.

318 TOURING & TRIKE

Rear Lighting

A. LIGHT BAR WITH LED BULLET TURN SIGNALS*

These Turn Signals feature fast-acting, extra-bright LEDs set in compact bullet-shaped die-cast housings. Available with red or smoked lenses, these lamps glow a bright red color when functioning as brake lamps, running lights and directional indicators. The kit includes the Rear Light Bar with integrated down-lighting for the license plate, bullet lamp housings and wiring. Installation does not require installation of a control box or load equalizer and the turn signals attach directly to existing wiring without cutting or splicing. These LED signals are the perfect match for the available LED Front Turn Signals. Meets DOT requirements.

Fits '17-later FLHRXS and '14-later FLHT, FLHX, FLXS, FLTRX, and FLTRXS models with Original Equipment rear bullet stop/turn/tail light bar.

67800493	Black – Red Lens.	\$319.95
67800494	Black – Smoked Lens.	\$319.95
67800492	Chrome – Smoked Lens.	\$319.95



A. LIGHT BAR WITH LED BULLET TURN SIGNALS – BLACK WITH SMOKED LENSES

B. BULLET REAR LIGHT BAR – GLOSS BLACK*

Complete the blacked-out treatment of your custom Touring bike. This complete kit replaces the Original Equipment chrome bar and lamps with a sinister black edition for a minimalistic look. The kit includes the Rear Light Bar with integrated down-lighting for the license plate, bullet lamp housings and wiring.

Fits '10-later Street Glide®, '10-later Road Glide®, '17-later FLHRXS and '19-later FLHT models with Original Equipment rear bullet turn signal light bar.

67800483	Domestic.	\$218.95
67800484	International.	\$437.95



A. LIGHT BAR WITH LED BULLET TURN SIGNALS – CHROME WITH SMOKED LENSES

C. TRI-BAR LIGHT UPGRADE – AUXILIARY RUNNING LIGHT/BRAKE LIGHT*

Upgrade the Original Equipment Tri-Bar fender light from a single-mode running light to a dual-mode running and brake light. The three smoked light bands glow red in the running mode and increase in intensity when the brakes are applied.

68358-07A		\$107.95
------------------	--	-----------------

Fits '06-'09 FLHX models.
67774-10 \$160.95
Fits '10-later FLHX and FLTRX models (except HDI models).

D. REAR FENDER TIP LIGHT – AUXILIARY RUNNING LIGHT/BRAKE LIGHT*

Upgrade your Touring model's Original Equipment fender tip light from a single-mode running light to a dual-mode running and brake light. The brilliant lamp glows red in the running mode and increases in intensity when the brakes are applied. The available smoked or red lenses complement any styling direction. Easy plug-in connection to the Original Equipment wiring harness.

59685-10	Red Lens.	\$116.95
-----------------	-----------	-----------------

Fits '09-'16 FLHTC, FLHTCU, FLHTCUL, FLHTK, FLHTKL and '16 FLTRU models.



C. TRI-BAR LIGHT UPGRADE – AUXILIARY RUNNING LIGHT/BRAKE LIGHT



B. BULLET REAR LIGHT BAR – GLOSS BLACK



D. REAR FENDER TIP LIGHT – AUXILIARY RUNNING LIGHT/BRAKE LIGHT



E. CURVED LICENSE PLATE FRAME WITH LED LIGHTING – CHROME



E. CURVED LICENSE PLATE FRAME WITH LED LIGHTING – GLOSS BLACK



F. CURVED LICENSE PLATE FRAME – TOURING, CHROME



F. CURVED LICENSE PLATE FRAME – TOURING, GLOSS BLACK



G. TOUR-PAK LUGGAGE AND SADDLEBAG INTERIOR LIGHT KIT – '14-LATER MODELS



H. TRUNK INTERIOR LIGHT KIT

Don't be left in the dark. This bright convenience lamp kit turns nighttime into day when you open your Trike's trunk. Two brilliant white LED light pods mount inside the trunk to illuminate the interior and the included contact switch turns the light on and off when you open and close the door. A 5-minute auto shut-off timer prevents battery drain. Kit includes wiring harness and installation hardware.

83946-11	Fits '09-later FLHTCUTG models.	\$90.95
-----------------	---------------------------------	----------------



G. TOUR-PAK LUGGAGE AND SADDLEBAG INTERIOR LIGHT KIT (68000151 SHOWN)



H. TRUNK INTERIOR LIGHT KIT



***WARNING:** Disconnecting your DOT-required tail, brake and turn signal lighting could reduce your visibility to others and result in death or serious injury.

Notice: The prices appearing in this catalog are the manufacturer's suggested retail prices. Actual retail prices may vary.



***WARNING:** Disconnecting your DOT-required tail, brake and turn signal lighting could reduce your visibility to others and result in death or serious injury.

Notice: The prices appearing in this catalog are the manufacturer's suggested retail prices. Actual retail prices may vary.

TOURING & TRIKE 319

Rear Lighting

E. CURVED LICENSE PLATE FRAME WITH LED LIGHTING*

Dress up the rear of your Street Glide® or Road Glide® model and add practical auxiliary lighting at the same time. Designed to replace the Original Equipment black license plate bracket, this curved license plate frame is shaped to hug the contours of the rear fender. The mount attaches to the underside of the rear turn signal bar, and the smooth license plate frame with signature Harley-Davidson script appears to float above the fender for a custom look. The frame features two vertical LED halo lights that glow while in the run mode and burn brightly when the brakes are applied. Kit includes all necessary harnesses and connectors to enable complete installation – no drilling or wire splicing is required. Available in your choice of chrome or gloss black finish.

Fits '10-later FLHRXS, FLHX, FLXS, FLHXST, FLTRX, FLTRXS and FLTRXST models.

67900275	Chrome.	\$170.95
67900273	Gloss Black.	\$170.95

F. CURVED LICENSE PLATE FRAME – TOURING

Love the look of your bike but hate the appearance of your state-mandated license plate? This stylish Curved License Plate Frame is shaped to hug the contour of the rear fender. Designed to replace the Original Equipment black license plate bracket, installation requires no drilling or rewiring. The front frame cover conceals the plate's mounting holes and raw edges and the curved shape hides the unfinished rear side of the plate. Available in chrome or gloss black finish, the complete kit includes all required mounting hardware.

Fits '10-later FLHRXS, FLHX, FLXS, FLHXST, FLTRX, FLTRXS and FLTRXST models.

67900008	Chrome.	\$100.95
67900058	Gloss Black.	\$100.95

Fits '09 FLHR, FLHT and FLTR and '06-'08 FLHX models.

67900056	Chrome.	\$100.95
-----------------	---------	-----------------

G. TOUR-PAK® LUGGAGE AND SADDLEBAG INTERIOR LIGHT KIT

Don't be left in the dark. This bright convenience lamp kit turns nighttime into day when you open your Tour-Pak® luggage or saddlebag. A brilliant white LED light pod mounts inside the Tour-Pak luggage to illuminate the interior and the two available LED light pods mount to the bottom of the Tour-Pak luggage to cast light inside the open saddlebags. Each LED light pod features a soft-touch micro switch for ease of activation and a 5-minute auto shutoff timer to prevent battery drain.

3-Light Tour-Pak & Saddlebag Light Kit

68000151		\$129.95
-----------------	--	-----------------

Fits '14-later Touring models equipped with rigid or detachable King Tour-Pak Luggage.

1-Light Tour-Pak Light Kit

68000152		\$100.95
-----------------	--	-----------------

Fits '14-later Touring models equipped with rigid or detachable King Tour-Pak Luggage.

320 TOURING & TRIKE

Electrical Accessories

A. AUXILIARY POWER PORT – HANDLEBAR MOUNT

Power your cell phone, GPS, portable music player or tire inflator from this handy 12-volt power port. The elegant cast housing features a conventional style power outlet that accepts most 12V automotive power adapter plugs and a pop-top cover to protect the port while not in use.

Fits '15-'20 XG, '14-'22 XL, '12-'17 Dyna®, '11-later Softail® (except FXDRS, and FXFB and FXFBS models with stock tapered bars), '14-later Road King®, and models with either 1" or 7/8" diameter handlebars. '17-later Road King® requires separate purchase of Electrical Connection Kit P/N 69201599A. '18-later Softail® models require separate purchase or Electrical Connection Kit P/N 69201750.

69200971	Chrome.	\$104.95
69200970	Black.	\$104.95

Fits '12-'17 Dyna, '11-later Softail (except FXDRS, and FXFB and FXFBS models with stock tapered bars), and '14-later Road King models with 1-1/4" diameter handlebars. '17-later Road King requires separate purchase of Electrical Connection Kit P/N 69201599A. '18-later Softail models require separate purchase of Electrical Connection Kit P/N 69201750.

69200855	Chrome.	\$104.95
69200854	Black.	\$104.95



A. AUXILIARY POWER PORT – HANDLEBAR MOUNT, BLACK



A. AUXILIARY POWER PORT – HANDLEBAR MOUNT, BLACK



A. AUXILIARY POWER PORT – HANDLEBAR MOUNT, BLACK



A. AUXILIARY POWER PORT – HANDLEBAR MOUNT, BLACK

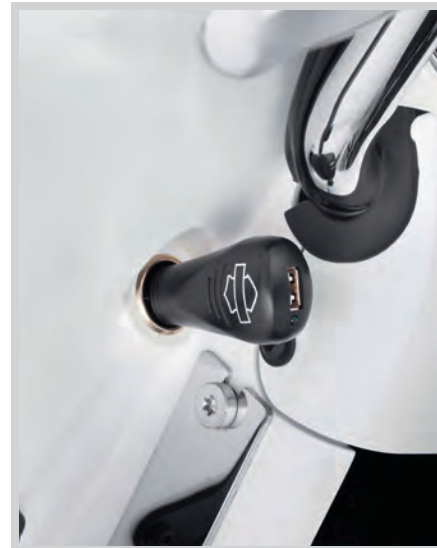

B. USB CHARGING ADAPTOR



C. AUXILIARY POWER PORT – TOUR-PAK MOUNT



D. AUXILIARY POWER PORT – SADDLEBAG MOUNT



TOURING & TRIKE 321

Electrical Accessories

B. USB CHARGING ADAPTOR

Charge your cell phone, MP3 players and other hand-held devices while on the road. Compact Adaptor plugs into standard or accessory 12-volt power ports, and provides a standard USB-style outlet that accepts many phone and music player power cords.

69200357		\$23.95
For use with Original Equipment or accessory 12V Auxiliary Power Port. Does not fit Electric Vehicles.		

AUXILIARY POWER PORTS

Power your cell phone, GPS, portable music player or tire inflator from this handy 12-volt power port. The conventional style power outlet accepts most 12V automotive power adapter plugs, and features a pop-top cover to protect the port while not in use.

C. AUXILIARY POWER PORT – TOUR-PAK® MOUNT

Easy-access power port mounts to the wall of the Tour-Pak® luggage, allowing you to recharge music players and cell phones in a secure locked location.

69200826		\$45.95
Fits '14-later FLHTCU, FLHTCUL and FLHTCUTG models. Original Equipment on FLHTK, FLHTKL, FLTRK, and FLHTCUTGSE models.		

91671-10		\$58.95
Fits '06-'13 FLHTC and FLTRU, '96-'13 FLHTCU and '09-'13 FLHTCUTG models. Also fits '06-'13 Touring models with accessory King Tour-Pak luggage and '98-'13 Touring models with Tour-Pak mounted rear speaker pods. Not for use with Accessory Fitted Liners or Premier Liner.		

D. AUXILIARY POWER PORT – SADDLEBAG MOUNT

This convenient power port mounts to the inside wall of the saddlebag, allowing you to charge cell phones and music players in an out-of-sight location. Power port features a quick-disconnect plug for use with detachable saddlebags.

69200091		\$48.95
Fits models equipped with 12-volt battery (except FXDRS, VRSC™, XG models, or with Throw-Over or Swingarm Bags). Not for use with accessory Fitted Liners or Premier Liner. Requires separate purchase of Battery Charging Harness P/N 94624-97B, if not already equipped.		

Notice: The prices appearing in this catalog are the manufacturer's suggested retail prices. Actual retail prices may vary.

Notice: The prices appearing in this catalog are the manufacturer's suggested retail prices. Actual retail prices may vary.

322 TOURING & TRIKE

Electrical Accessories

A. AUXILIARY POWER SWITCH KIT – FAIRING MOUNT

Styled to match the Original Equipment fairing dash panel switches. These Auxiliary Power switches allow you to control additional fog lamps, auxiliary lighting, heated gear or electrical accessories with the touch of a finger. Kit includes two auxiliary switches, wire harnesses and installation hardware.

71400129 \$149.95
Fits '17-later Electra Glide®, Street Glide®, Road Glide®, Ultra Limited and Tri Glide® models. Does not fit CVO™ models.

71400106 \$84.95
Fits '14-'16 Electra Glide, Ultra Limited, Road Glide Ultra and Tri Glide models.

71400105 \$129.95
Fits '14-'16 Road Glide, Street Glide and Ultra Limited models. Includes dash switch assembly mount.



A. AUXILIARY POWER SWITCH KIT – FAIRING MOUNT (71400129 SHOWN)



B. ELECTRICAL CONNECTION UPDATE KIT – TOURING

Harness plugs into accessory connector to provide 12-volt power leads. Required to install Heated Grips, XM Radio, Cruiser Amp & Speaker Systems, zūmo® GPS, Digital Oil Pressure Gauge, Garage Door Opener Kits, Heated Seats, decorative lighting or other electrical accessories.

69201599A \$39.95
Fits '18-later Softail® models and '17-later Touring and Trike as a mid-bike connector (near the seat).

69200722 \$33.95
Fits '14-'16 Touring and Trike models.



A. AUXILIARY POWER SWITCH KIT – FAIRING MOUNT (71400105 SHOWN)



C. SWITCHED CIRCUIT ADAPTER HARNESS

This harness allows two accessories to be connected to the switched accessory circuit featured on '94-later Touring models. You then may switch two accessories on or off simultaneously as required.

70264-94A \$23.95
Fits '94-later Touring and Trike models. Required on '14-later Touring and Trike models when connecting multiple powered accessories using Electrical Connection Kit P/N 69200722, 71400129, or 69201599A.

69201706 \$28.95
Fits '18-later Softail models and '17-later Touring and Trike models. Required when connecting the CoolFlow™ Fan and another powered accessory using Electrical Connection Kit P/N 69201599A.

Also available: ELECTRICAL ACCESSORY ADAPTER

Harness accommodates the addition of multiple electrical accessories to the main battery power circuit on specified models.

70270-04A \$19.95
Fits '07-'17 VRSC™, '04-'13 XL and XR, '04-'11 Dyna®, '04-'10 Softail and '04-'13 Touring models. Also fits '14-later Touring and Trike models when equipped with a third or fourth pair of Boom!™ Audio Stage II speakers.



B. ELECTRICAL CONNECTION UPDATE KIT – TOURING (69201599A SHOWN)



B. ELECTRICAL CONNECTION UPDATE KIT – TOURING (69200722 SHOWN)

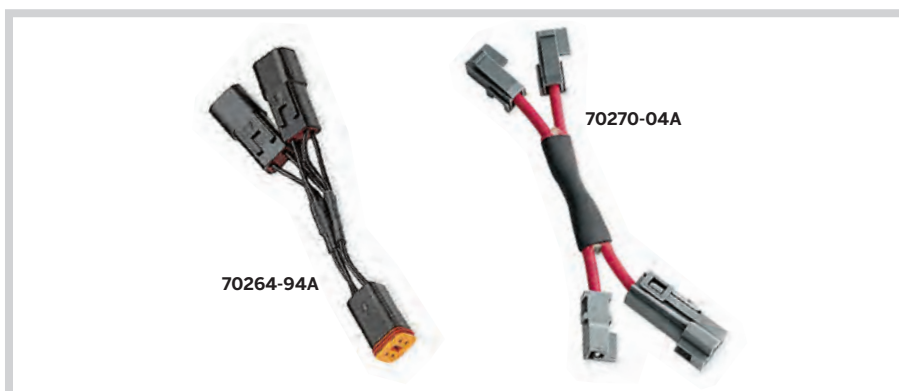

C. SWITCHED CIRCUIT ADAPTER HARNESS & ELECTRICAL ACCESSORY ADAPTER



D. 54-AMP HIGH OUTPUT CHARGING SYSTEM



E. 45-AMP CHARGING SYSTEM FOR ELECTRA GLIDE MODELS

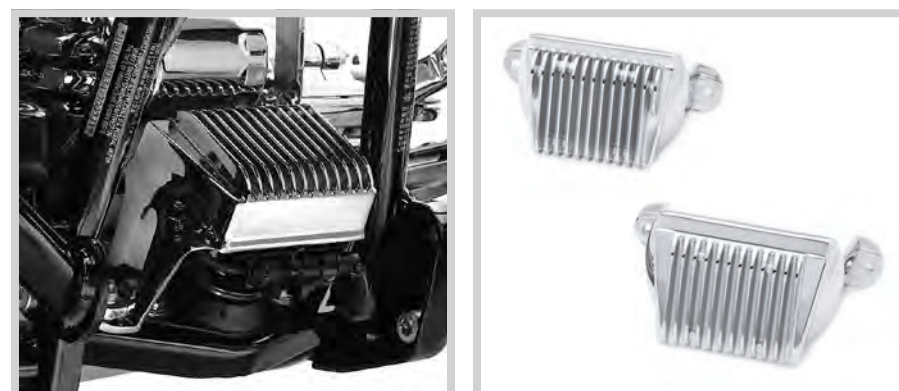

F. VOLTAGE REGULATOR – CHROME TOURING

TOURING & TRIKE 323

Electrical Accessories

D. 54-AMP HIGH OUTPUT CHARGING SYSTEM

The Harley-Davidson® High Output Charging System is engineered to provide 30% more power than the stock system at idle. With 54 amps of output at 4000 rpm, accessories will operate at their peak performance – no more dimming lights, reduced audio performance or under-performing heated gear. This is a recommended installation anytime a multi-amp audio system is installed on the vehicle in order to achieve the full capability of your audio system. It is also recommended when installing heated seats, heated gear and other higher-draw powered accessories.

Stock on select CVO™ Touring models, the complete kit includes high performance rotor, stator, voltage regulator and all gaskets and hardware required for installation.

29900028A \$557.95
Fits '11-'16 Touring, '10-'16 CVO Touring and '09-'16 Trike models. Stock on '14-'16 FLHTKSE, FLHXSE and FLTRUSE.

E. 45-AMP CHARGING SYSTEM FOR ELECTRA GLIDE® MODELS

Standard equipment on H-D® Touring-style Police motorcycles, this high-output charging system knows how to work for a living. Add more electronics – including lights – on your Electra Glide® model without worrying about whether you've got the juice to back it up.

29999-97B \$286.95
Fits '99-'05 FLHT models.

Also available: (not shown) 32-AMP HIGH-OUTPUT ALTERNATOR KIT

Stock on all '89-later carbureted 1340 models. 50% increase in amperage for the heavily accessorized motorcycle.

29985-87 \$266.95
Fits '84-'88 FLT, FLHT, and FXR (wet clutch) models. (Will not fit '84-'88 Softail®.) Stock on all '89-'95 and some '96-'97 Evolution® 1340-equipped models.

F. VOLTAGE REGULATOR – CHROME

Original Equipment voltage regulators with a sparkling triple-plated chrome finish. Hand-buffed, then copper-, nickel- and chrome-plated, these brilliant chrome-plated regulators are the perfect highlight for any Harley-Davidson® motorcycle.

74622-09 \$213.95
Fits '09-'16 Touring and Trike models (except '14-later FLHRSE and FLHTKSE and '15-later FLHXSE and FLTRUSE).

74622-06 \$213.95
Fits '06-'08 Touring models.

74622-04 \$213.95
Fits '04-'05 Touring models.

324 TOURING & TRIKE

Chassis Trim – Trike

A. WHEEL CENTER COVER KIT

These chrome-plated hubcaps add style and depth to the Trike's rear wheels. The snap-fit covers have no visible fasteners for a clean, custom look.

83841-09 **\$48.95**
Fits '09-later FLHTCUTG, '10-'11 FLHXXX, '15-later FLRT and '23-later FLTRT models. Installation on Original Equipment wheel requires removal of wheel and factory center medallion.



A. WHEEL CENTER COVER KIT

B. EXHAUST TRIM

This chrome-plated accent piece trims the exhaust openings in the trunk fascia and adds a touch of brightwork to the rear of the bike. Easy to install with no visible fasteners, the formed steel trim features pre-applied high-temp adhesive backing for a clean, uncluttered look.

83843-09 **\$45.95**
Fits '14-later Tri Glide® models. Does not fit CVO™ Tri Glide models. Will not fit with Illuminated Fascia Accent Trim P/N 68000129



B. EXHAUST TRIM

C. TRIKE MUD FLAPS – TRI GLIDE LOGO

Custom-fit Mud Flaps protect the sides of your Trike's trunk box from spray and road debris and keep the finish clean and free of mud and tar buildup. Custom molded for a perfect fit, these matte black mud flaps feature a raised light gray Tri Glide script logo. Kit includes left and right mud flap, reinforcing brackets and mounting hardware.

59600018 **\$64.95**
Fits '09-later FLHTCUTG and '10-'11 FLHXXX models.



C. TRIKE MUD FLAPS – TRI GLIDE LOGO

D. TRUNK GUARD

Unique rear guard wraps around the bodywork to protect your finish from damage. Lightweight steel tubing incorporates high-quality welded joints and is hand-polished and chrome-plated for a brilliant finish. Kit includes all necessary mounting hardware for bolt-on installation.

83825-09B **\$268.95**
Fits '09-later FLHTCUTG and '10-'11 FLHXXX models.
49000069 **\$273.95**
Chrome.
Fits '15-later FLRT and '23-later FLTRT models.



D. TRUNK GUARD – TRI GLIDE

E. ILLUMINATED FASCIA ACCENT TRIM*

Sweeping chrome trim dresses the trunk fascia for a distinctive yet functional look. The inset LED light bar glows as a running lamp when the ignition is on and functions as an auxiliary red lamp when the brakes are applied. Available with smoked or red LED lens to match your customizing direction. Can be installed on models equipped with Trunk Guard.

68000129 **\$266.95**
Red Lens.
Fits '14-later Tri Glide models. Does not fit CVO Tri Glide models. Will not fit with Exhaust Trim P/N 83843-09.



D. TRUNK GUARD – FREEWHEELER – CHROME



E. ILLUMINATED FASCIA ACCENT TRIM – RED LENS



***WARNING:** Disconnecting your DOT-required tail, brake and turn signal lighting could reduce your visibility to others and result in death or serious injury.

Notice: The prices appearing in this catalog are the manufacturer's suggested retail prices. Actual retail prices may vary.

TOURING & TRIKE 325

Paint Protection

TRANSPARENT PAINT GUARD KITS

This transparent skin is designed to protect your paint from bugs, boot scuffs and road debris. The crystal-clear material protects the paint without changing the overall look of your bike. And the optical properties of the material disguise minor scuffs and scratches. The application process is similar to that of tinted window film and the material can be removed and replaced when it is no longer cosmetically appealing. Scratches to paint can be expensive to repair but scratches to this film can be removed by applying a small amount of heat with a heat gun.

F. SADDLEBAG LID

11100098 **\$84.95**
Fits '14-later Touring models with Color-Matched Hard Saddlebags. Does not fit models with leather-covered bags, or Boom!™ Audio Speaker Lids. Not recommended for use on denim or aftermarket paint.



F. TRANSPARENT PAINT GUARD KITS –SADDLEBAG LID

G. TOURING SIDE COVERS

11100078 **\$43.95**
Fits '97-later Touring models. Not recommended for use on denim or aftermarket paint.

Also available FRONT FENDER

11100080 **\$43.95**
Fits FLD, most FL Softail® (except Springer™), Touring, FLHTCUTG and FLHXXX models. Not recommended for use on denim or aftermarket paint.

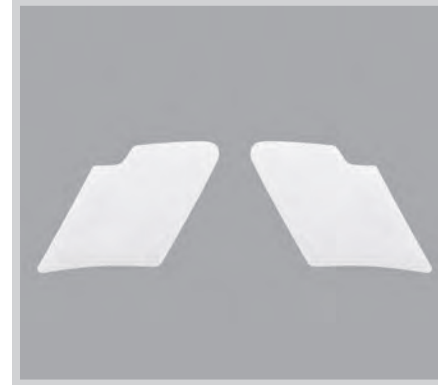

G. TRANSPARENT PAINT GUARD KITS – TOURING SIDE COVERS

H. TRANSPARENT PAINT GUARD KIT – TRIKE

This transparent skin is designed to protect parts of the Trike bodywork from boot scuffs and road debris. The crystal-clear material protects the area surrounding the passenger footboard and is pre-cut to fit the leading and inner surface of the rear fender, the fascia panel of the trunk and the side covers. Scratches in the material can be "healed" by applying a small amount of heat with a heat gun. The application process is similar to that of tinted window film and the material can be removed and replaced when it is no longer cosmetically appealing.

83989-10A **\$144.95**
Fits '09-later FLHTCUTG and '10-'11 FLHXXX models. Not recommended for use on denim or aftermarket paint.

11100125 **\$144.95**
Fits '15-later FLRT models. Not recommended for use on denim or aftermarket paint.



F. TRANSPARENT PAINT GUARD KITS – SADDLEBAG LID '14-LATER MODELS



H. TRANSPARENT PAINT GUARD KIT (83989-10A SHOWN)



H. TRANSPARENT PAINT GUARD KIT (11100125 SHOWN)

I. FAIRING BRA – BATWING FAIRING

Offering a custom look and protection from the elements for your fairing, this Fairing Bra is made with non-abrasive, fleece-backed vinyl material and features a Bar & Shield logo. It is designed for easy installation and a custom fit.

57000307 **\$118.95**
Fits '14-later Electra Glide®, Street Glide®, Ultra Limited and Tri Glide® models.

57800-00 **\$118.95**
Fits '96-'13 Electra Glide, Street Glide and Trike models. Requires separate purchase of Chrome Windshield Trim P/N 59213-96.



I. FAIRING BRA – BAT WING FAIRING (57000307 SHOWN)



I. FAIRING BRA – BAT WING FAIRING (57800-00 SHOWN)

Notice: The prices appearing in this catalog are the manufacturer's suggested retail prices. Actual retail prices may vary.















Fat Bob® 114 - Screamin' Eagle High-Flow Exhaust System

HARLEY-DAVIDSON®

SCREAMIN' EAGLE

Screamin' Eagle® Performance Stage Kits take performance to the next level with increased acceleration and improved passing power when compared to stock bikes. Everything from enhanced air intakes and engine kits to exhaust components and suspension. Screamin' Eagle Performance Parts and Accessories will blow minds on and off the road.

STAGE UPGRADES: PATH TO PERFORMANCE

	START HERE	CHOOSE FROM BELOW	ADD EVEN MORE POWER	
STAGE	 <p>STAGE I </p> <p>MOVE MORE AIR & FUEL</p> <p>INTAKE + EXHAUST + TUNING UPGRADE = FOUNDATION FOR ALL FUTURE STAGES</p>	 <p>STAGE II </p> <p>GIVE IT A LIFT</p> <p>STAGE I + CAM UPGRADE</p>	 <p>STAGE III </p> <p>PUMP UP THE VOLUME</p> <p>STAGE II + BIG BORE CYLINDERS & PISTONS</p>	 <p>STAGE IV </p> <p>TOP IT OFF</p> <p>STAGE III + CYLINDER HEADS & THROTTLE BODY</p>
BENEFITS	Ideal for riders who want to enhance the performance, look and sound of their motorcycle	<p>TORQUE KIT: Ideal for riders looking for instant passing power at cruising speeds</p> <p>POWER KIT: Ideal for riders who want to feel the power build and pull all the way to the redline</p>	Ideal for riders who want the largest engine displacement and increased power throughout the entire RPM range	Ideal for riders who want the absolute best Harley-Davidson® performance upgrade available
BASICS	<ul style="list-style-type: none"> • Most cost-effective step to improve performance and the foundation for future performance upgrades • Match any Screamin' Eagle® high-flow air cleaner and exhaust with the proper ECM calibration to increase the airflow into and out of the engine 	<ul style="list-style-type: none"> • Choose a TORQUE CAM or POWER CAM based on riding style • A performance cam increases both the lift in the valve train (pushing the valve open farther) and the duration of the valve opening (how long the valve stays open) 	<ul style="list-style-type: none"> • An increase in engine displacement allows the engine to swallow more air and fuel, while a higher-compression piston squeezes the air and fuel into a more volatile mixture, generating more power when ignited • Displacement increases are accomplished with larger cylinders, matching pistons and the proper cam upgrade 	<ul style="list-style-type: none"> • Highest-level performance upgrade available to provide a maximum increase in displacement, compression and flow • Higher-flowing CNC ported cylinder heads and larger bore throttle body increase the velocity and feed large volumes of air and fuel into the engine, which maximizes power on a larger displacement engine • Combines ported cylinder heads and larger throttle body in combination with cylinders, matching pistons and proper cam upgrade
PERFORMANCE	 <p>The rider will feel up to a 10%* increase in performance when compared to stock bikes throughout the entire RPM range</p>	 <ul style="list-style-type: none"> • TORQUE KIT: The rider will feel up to a 15%* increase in performance when compared to stock bikes in the low to mid RPM range • Experience crisp throttle response and acceleration that can be felt at slower speeds, perfect for passing slow-moving vehicles without downshifting  <ul style="list-style-type: none"> • POWER KIT: The rider will feel up to a 25%* increase in performance when compared to stock bikes in the mid to upper RPM range • Experience an adrenaline-pumping burst of speed while heading toward the redline 	 <ul style="list-style-type: none"> • Riders will experience a performance increase throughout the entire RPM range, with up to a 35%* increase when compared to stock bikes in the mid to upper RPM range • Produces instant passing power without downshifting • Delivers excellent stoplight to freeway speed and on-ramp acceleration 	 <p>The rider will feel exceptional acceleration, delivering significant gains and up to a 40%* increase when compared to stock bikes in the upper RPM range</p>

AN OVERVIEW OF WARRANTY & CAUTION: Harley-Davidson® has the engineering expertise, sophisticated dyno lab and complete testing facilities to provide enthusiasts with a line of performance products designed to produce good, solid, reliable horsepower and torque. Engine-related performance parts are intended for the experienced rider only.

WARRANTY: Installation of Screamin' Eagle® products and similar off road or competition products could impact your H-D™ motorcycle limited warranty claims. Specifically, Harley-Davidson may exclude motorcycle limited warranty coverage for defects or damage caused by use of unauthorized parts, including defects or damage caused by use of non-Genuine Harley-Davidson parts or use of the vehicle for racing or competition, and denial of coverage may be based on installation of parts designed for unauthorized uses of the vehicle, such as a trailer hitch. Additionally, Harley-Davidson shall exclude motorcycle limited warranty coverage and deny all motorcycle limited warranty claims for functional defects of powertrain components for any Harley-Davidson motorcycle registered in the United States if the vehicle was tuned using a tuning product not covered by a California Air and Resources Board Executive Order or that was otherwise approved by the Environmental Protection Agency, or if Harley-Davidson or any authorized Harley-Davidson dealer has any information to show that the vehicle was tuned using a tuning product not covered by a California Air and Resources Board Executive Order or that was otherwise approved by the Environmental Protection Agency.

CAUTION ICONS

GO LIGHT: These Screamin' Eagle® products are 50-State U.S. EPA compliant for sale and use on all applicable vehicles, including those that are pollution controlled. See Genuine Motor Parts and Accessories or Screamin' Eagle Accessories catalog for fitment information. Screamin' Eagle Performance products are intended for the experienced rider only.

STOP HAND: Harley-Davidson® motorcycles modified with some Screamin' Eagle® Performance products must not be used on public roads and, in some cases, may be restricted to closed-course competition. These performance parts are 49-state U.S. EPA compliant but are NOT compliant for sale or use in California on pollution-controlled motor vehicles. California guidelines on tampering can also lead to substantial fines and penalties. Screamin' Eagle® Performance products are intended for the experienced rider only.

CAUTION: Harley-Davidson motorcycles modified with some Screamin' Eagle high-performance engine parts must not be used on public roads and, in some cases, may be restricted to closed-course competition.

CALIFORNIA: These Screamin' Eagle® products are street compliant for sale and use on specific vehicles, outlined in the product's fitment statement within the State of California. Screamin' Eagle Performance products are intended for the experienced rider only.

CROSS FLAGS: This product may be intended for race use only applications. It may also be certified for use in a 50-State U.S. EPA compliant application or kit. Use of any incomplete combination of certified kit products may not be legal for sale or use on U.S. market pollution-controlled vehicles and may be restricted to closed course competition use. See Genuine Motor Parts and Accessories or Screamin' Eagle Accessories catalog for compliance, fitment and warranty information. Screamin' Eagle Performance products are intended for the experienced rider only.

DYNAMOMETER (DYNO) PERFORMANCE TESTING: Declared performance values in this catalog represent SAE J-1349 transient peak power output. Dynamometer settings, motorcycle condition, variation, climate and other factors can affect performance output, and results can vary from the performance values declared by Harley-Davidson.

Street-legal and/or street-compliant statements refer to product meeting 50-state emissions and noise standards in the United States. The street legal and/or street compliant statements may not apply to markets outside of the United States.

Not all products are available in all countries — please consult your dealer for details.

Stage upgrades retain the Motorcycle Original Equipment Manufacturer's Warranty.

*Dynamometer settings, motorcycle condition, variation, climate and other factors can affect performance output, and results can vary from the performance values declared by Harley-Davidson.

TUNING FOR PERFORMANCE

FIRST THINGS FIRST:

You've built your dream pavement-pounding machine by selecting one of the Screamin' Eagle® Stage upgrades.



2 Next, the motorcycle Engine Control Module (ECM) needs to be recalibrated. Screamin' Eagle offers base calibrations specifically designed for the performance components on your bike.



3 Tuning adjusts the air-fuel ratio and other parameters based on your performance upgrades.

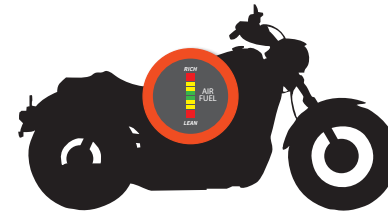

4 The end result? A properly tuned performance machine that gets the most out of your performance upgrades.

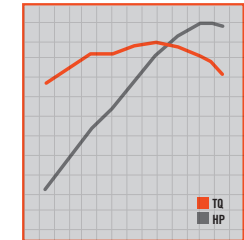

START HERE

PRO STREET TUNER*

- Offers base calibrations for your chosen Screamin' Eagle Stage upgrade
- Constantly monitors the engine operation in the Part-Throttle Cruising Range
- Enables manual adjustments to fine-tune parameters within part- and full-throttle ranges*



(*may not be available in all markets)

WANT MORE?

SMART TUNE PRO

- Uses the Pro Street Tuner base calibrations as a starting point
- Constantly monitors the engine operation and riding conditions in the Complete Motorcycle Operating Range
- Automatically adjusts tuning parameters in real time within the Complete Motorcycle Operating Range



THE HOW

- 1 Load base calibration
- 2 All done; go ride or **manually** adjust with Dyno tuning or Smart Tune Live

THE WHAT

COMPLETE MOTORCYCLE OPERATING RANGE

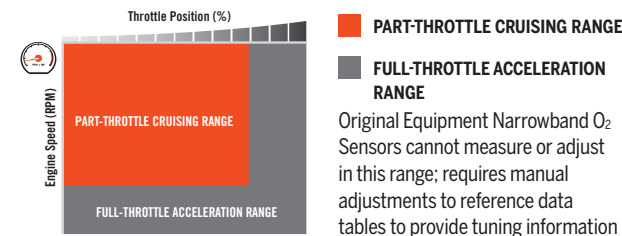

COMPLETE MOTORCYCLE OPERATING RANGE

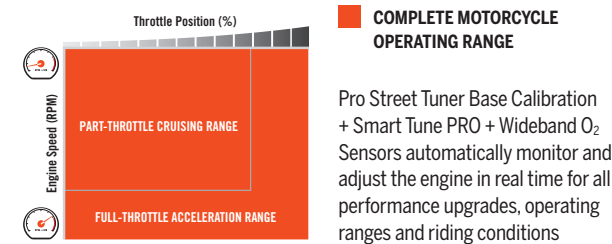

THE BENEFIT

MANUAL ADJUSTMENT FOR
Maximum Performance + Optimal Efficiency for your bike



AUTOMATIC ADJUSTMENT FOR
Maximum Performance + Optimal Efficiency + Automatic Adjustment for your bike in all riding conditions and combinations of performance upgrades



PRO STREET TUNER

All Screamin' Eagle® performance upgrades require Engine Control Module (ECM) recalibration, also known as tuning. The best method for tuning your stage upgrades is with the Screamin' Eagle Pro Street Tuner.

- Provides starting calibrations developed by the Screamin' Eagle team
- Offers ability to dial in bike-to-bike variations and different air cleaner and exhaust combinations
- Offers Guided Smart Tune process, which walks user through tuning with or without a dyno
- Allows adjustments within a safe range for optimum performance excitement
- Maximizes the performance output while maintaining 50-State U.S. EPA compliance
- Retains the Motorcycle Original Equipment Manufacturer's Warranty



SCREAMIN' EAGLE® PRO STREET TUNER

The Screamin' Eagle® Pro Street Performance Tuner is designed to simplify management of engine operating parameters as performance modifications are made. Once installed, the kit will allow you to adjust key parameters or simply upload the latest Engine Control Module (ECM) calibrations to match your bike's state-of-tune. Start with a high-flow air cleaner and Street Performance mufflers and upload the calibration that provides the best performance mix. Add additional Stage Upgrades later, and you simply upload the proper ECM calibration to match the model and hardware. Plus, you have free online access to the latest factory calibrations.

Ideal for real-world street performance applications, the Pro Street Tuner provides the adjustability to account for bike-to-bike variation and for changes to cams, heads, intake and exhaust while maintaining closed-loop fuel control for fuel economy in the part-throttle operating range. Unlike other aftermarket tuners, the Screamin' Eagle Pro Street Tuner actually talks directly to your motorcycle's ECM and re-programs the motorcycle's operating system. It isn't a piggyback system that tries to fool the ECM into adding more fuel or changing the ignition timing. The Pro Street Tuner plugs into the bike's data port, so no splicing or under-seat hardware is required.

After you upload the proper ECM calibration, dial it in with the Smart Tune function. The guided Smart Tune process walks you through the process to find the right calibration for your build, set the tuner to a data collection mode and then allows you to incorporate the data after the ride with just a few clicks. The ECM calibration is then custom fit for your bike. The module will store up to 15 minutes of run-time data information that can be downloaded to your PC, allowing the rider or technician to view and evaluate the bike's air/fuel ratio, O₂ sensor readings, engine speed and temperature, RPM and vehicle speed, throttle position, spark advance and many more performance characteristics. The Vehicle Communications Module (VCI) will also record and display service codes for troubleshooting and diagnostics. The kit includes the VCI module and unlimited access to the latest software updates and calibrations available from Screamin' Eagle. Tuner Cable kit sold separately.

The Pro Street Tuner software includes impressive features:

- A guided Smart Tune process to enable quick navigation through the software, whether you are new to tuning or an experienced user.
- Smart Tune Live – a dynamic and visual method to track and capture engine data simply by running the vehicle through a range of RPM and throttle positions. This feature reduces the time to modify existing VE (Volumetric Efficiency) tables, which are then analyzed and tuned. Smart Tune Live works on models with factory-installed O₂ sensors only.
- Adjustability to Spark Advance, Throttle Progressivity and Volumetric Efficiency to custom tune the performance combination.
- 50-State U.S. EPA compliant.

The Pro Street Tuner permits tunability to optimize performance and drivability without compromising fuel efficiency, emission levels, engine durability, or 50-State U.S. EPA compliance. And unlike other race tuners or engine controllers, the Screamin' Eagle Pro Street Tuner does not impact your Harley-Davidson® factory warranty coverage.

41000008C \$368.95

For use with '17-'20 XG, '14-'22 XL and '07-'17 Dyna®, and '07-later Softail® and Touring and '17-later Trike models. Requires separate purchase of model-specific Tuner Cable.

41001212A \$368.95

For use with '17-20 XG, '14-22 XL and '07-17 Dyna, and '07-22 Softail and Touring and '17-22 Trike California models only. Requires separate purchase of model-specific Tuner Cable. California Dealership installation only. Refer to H-D.com/shop for status.

FEATURES

	PRO STREET TUNER
Street-Use (EPA/CARB) Calibrations	Yes – Stage 1, 2, 3 & 4
SE Pro (Race-Use Only) Calibrations	No
Retains Full Engine Warranty	Yes
Tuning Parameters*:	
<i>Volumetric Efficiency</i>	Tunable – All
<i>Throttle Progressivity</i>	Tunable – '14-later Touring
<i>Spark Advance – Tunable</i>	'17-'20 XG '14-'22 XL '12-'17 Dyna '12-later Softail '14-later Touring
<i>RPM Max</i>	View Only
<i>Idle RPM</i>	View Only
<i>Accel Enrichment</i>	View Only
<i>Decel Enleanment</i>	View Only
Data Recording (select markets)	15 minutes
Smart Tune LIVE (select markets)	Yes
Graphical Data Display	Yes
Service Codes Display/Clear	Yes
Available for VRSC™ and XR models	No
Language Support	English, Spanish, German, French, Japanese, Italian, Portuguese, Dutch

Also available:

SCREAMIN' EAGLE TUNER CABLE KIT

Cable kit provides all necessary connections between motorcycle, VCI and computer, and permits downloading calibrations with the Street Tuner and Super Tuner software. Kit includes two cables: computer USB to VCI box and VCI box to vehicle.

32184-08A \$49.95

For use with '01-'17 VRSC™, '01-'13 EFI XL and XR, '01-'11 EFI Dyna, '01-'11 EFI Softail, '02-'13 EFI Touring and '09-'13 Trike models. Also for use with VRXSE Destroyer race bikes.

41000018 \$38.95

For use with '15-'20 XG, '14-'22 XL, '12-'17 Dyna, '11-'20 Softail, '14-'20 Touring and '14-'20 Trike models. Screamin' Eagle performance upgrades for FLSB are 49-state U.S. EPA approved. Pending approval for use in California.

41000979 \$38.95

For use with '21-later Touring, Trike, Softail, and CVO™ models. Does not work with Sportster or Street models.

TUNING FOR PERFORMANCE

START HERE: PRO STREET TUNER

- Base calibrations for each Screamin' Eagle® Stage upgrade
- Constantly monitors the engine operation in the Part Throttle Cruising Range
- Enables MANUAL adjustments to fine-tune parameters within part and full throttle ranges (not available in all markets)

The result? MANUAL ADJUSTMENT for Maximum Performance + Optimal Efficiency

WANT MORE? ADD SMART TUNE PRO

- Uses Pro Street Tuner base calibrations as a starting point
- Constantly monitors engine operation and riding conditions in the Complete Motorcycle Operating Range
- AUTOMATICALLY adjusts tuning parameters in REAL TIME within the Complete Motorcycle Operating Range

The result? AUTOMATIC ADJUSTMENT for Maximum Performance + Optimal Efficiency + Automatic Adjustment for all riding conditions and performance upgrades

Street legal and/or street compliant statements refer to product meeting 50-State emissions and noise standards in the United States. The street legal and/or street compliant statements may not apply to markets outside of the United States.



A. SCREAMIN' EAGLE SMART TUNE PRO AUTOMATIC TUNING MODULE

A. SCREAMIN' EAGLE® SMART TUNE PRO AUTOMATIC TUNING MODULE*

Smart Tune PRO works with the Screamin' Eagle® Pro Street Tuner to automatically adjust your bike for the combination of performance components, climates and vehicle load conditions you are operating in. You just install the upgraded wide-band oxygen sensors in the exhaust headers, download the calibration that the Screamin' Eagle engineers have developed as a starting point, then simply drive down the road and let Smart Tune PRO do the work.

Smart Tune PRO constantly monitors the operating parameters of your motorcycle, and automatically adjusts the bike's Electronic Control Module (ECM) to maximize performance in your current riding conditions. Smart Tune PRO utilizes wide-band O₂ sensors that read oxygen levels in the exhaust stream to determine the optimum air/fuel ratio your bike needs at this very moment. Smart Tune PRO analyzes the data and automatically makes real-time tuning adjustments to the ECM. Unlike the standard narrow-band O₂ sensors that only provide feedback in the part-throttle cruising range, the wideband sensors can read and adjust tuning throughout the part throttle cruising and full-throttle acceleration operating range.

It is fully factory supported, and optimized to maximize performance while maintaining drivability and engine longevity. Smart Tune PRO is 50-State EPA compliant and does not impact the H-D™ factory warranty. Kit includes the Smart Tune PRO module with plug-in wiring harness, two M18 wide-band O₂ sensors and access to free software updates, future calibrations and free online training modules. Screamin' Eagle Pro Street Tuner and model-specific installation hardware is sold separately.

41000445A \$463.95

Fits '14-'22 XL, '16-'17 Dyna® FXDLS, '16-'20 Softail®, '14-'20 Touring and '17-'20 Trike models. Installation requires exhaust modification to incorporate wide-band oxygen sensors. Some models require Oxygen Sensor Harness Extension. For model specific installation requirements see Installation Instructions on H-D.com/shop. All models require ECM calibration with Screamin' Eagle® Pro Street Tuner for proper installation. 50-State U.S. EPA Compliant.

Also available: (not shown)

OXYGEN SENSOR HARNESS EXTENSION

Plug-in extension cable is wired to allow installation of the Screamin' Eagle Smart Tune PRO Automatic Tuning Module hardware on specific models. No splicing or soldering is required.

69201704 \$33.95

Required for use of Screamin' Eagle Smart Tune PRO Automatic Tuning Module hardware on, '16-'17 Dyna and Softail models.

Notice: The prices appearing in this catalog are the manufacturer's suggested retail prices. Actual retail prices may vary.

Street legal and/or street compliant statements refer to product meeting 50-State emissions and noise standards in the United States. The street legal and/or street compliant statements may not apply to markets outside of the United States. Tuning parameters may not be available in all markets. Check your local dealership for more information. Notice: The prices appearing in this catalog are the manufacturer's suggested retail prices. Actual retail prices may vary.

MILWAUKEE-EIGHT® POWERTRAIN

Screamin' Eagle® Stage upgrades offer complete street-compliant performance configurations engineered to generate specific torque and horsepower gains. Eliminating all the guesswork and trial-and-error testing normally associated with engine modifications, Stage upgrades include everything you need to enhance your bike's performance. Start with the foundation, the Stage I upgrade, then choose from Stage II, III or IV depending on your performance goals, budget and riding style.



STAGE I

INTAKE + EXHAUST + TUNING

The easiest and most cost effective step to improve your motorcycle's performance is to increase the airflow into and out of the engine. A high-flow air cleaner and system-matched slip-on mufflers provide horsepower and torque improvements you can feel throughout the RPM range, and serve as the core components for all performance upgrades. ECM calibration is required to tune the fuel flow and timing required to accommodate the improved airflow.

Stage I upgrade can be installed without engine disassembly. No special tools are required. Requires ECM tuning.



Street legal and/or street compliant statements refer to product meeting 50-State emissions and noise standards in the United States. The street legal and/or street compliant statements may not apply to markets outside of the United States.

STAGE II

STAGE I + CAM UPGRADE

Adding performance cams to a Stage I equipped bike is the next step to improved performance. Cam choices allow you to tailor the engine's performance to your specific needs. A torque cam offers on-demand throttle response from low- to mid-RPM at cruising speed. A power cam targets high-RPM, wide-open throttle response that keeps pulling right up to the redline. ECM calibration tuning is required to accommodate the increased valve timing, and performance valve springs may be required for high-lift cams.

Stage II upgrade requires minor engine disassembly to replace the cam. Adjustable pushrods allow cam installation without removing the rocker box. Special tools and ECM tuning are required.



STAGE III

STAGE I + CAM, BIG BORE CYLINDERS & PISTONS

The next step on the performance journey is to build a bigger engine. An increase in engine displacement allows the engine to swallow more air and fuel, a higher compression piston squeezes the air/fuel into a more volatile mixture, and when combined, generates more power when ignited. A displacement and compression increase provides torque increases throughout the entire RPM range with a 15-25% improvement in the mid-range power. ECM calibration tuning is required to adjust fuel flow and timing to accommodate the increased displacement.

Stage III bolt-on upgrade requires removal of the engine's top end and opening the cam chest. Engine remains in the chassis and no machining is required. Special tools and ECM tuning are required.

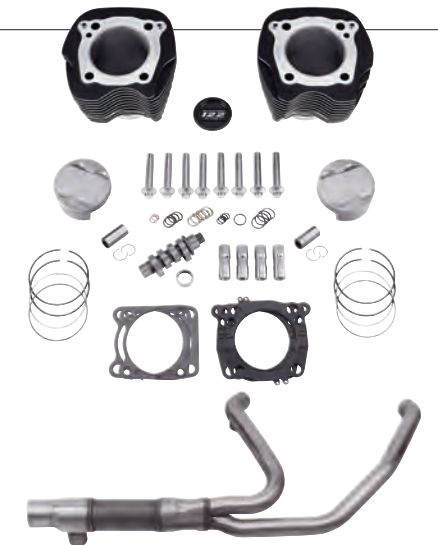

STAGE IV

STAGE I + CAM, BIG BORE CYLINDERS, PISTONS, CYLINDER HEADS & THROTTLE BODY

To maximize the impact of the increased displacement gained with Stage III updates, the addition of free-flowing ported cylinder heads and a big bore throttle body top off the performance build. Designed to satisfy the high-RPM, throttle-twisting rider, the Stage IV update delivers 20-30% increase in power that keeps pulling right up to the redline, without sacrificing mid-range torque. ECM calibration tuning is required to add more fuel, and a higher-lift cam may be required to deliver maximum power.

Stage IV bolt-on upgrade requires removal of the engine's top-end and opening the cam chest. Engine remains in the chassis and no machining is required. Special tools and ECM tuning are required.



Street legal and/or street compliant statements refer to product meeting 50-State emissions and noise standards in the United States. The street legal and/or street compliant statements may not apply to markets outside of the United States.

MILWAUKEE-EIGHT® POWERTRAIN

Screamin' Eagle® Stage upgrades offer complete street-compliant performance configurations. Whether you're a Softail® or Touring rider, Screamin' Eagle offers the full gamut of Stage upgrades for you to pick the best solution for you. Use the Rear Wheel Horsepower and Torque charts to identify a combination that would work best for your riding style and performance needs.

SOFTAIL® 107CI MODEL STAGE UPGRADES

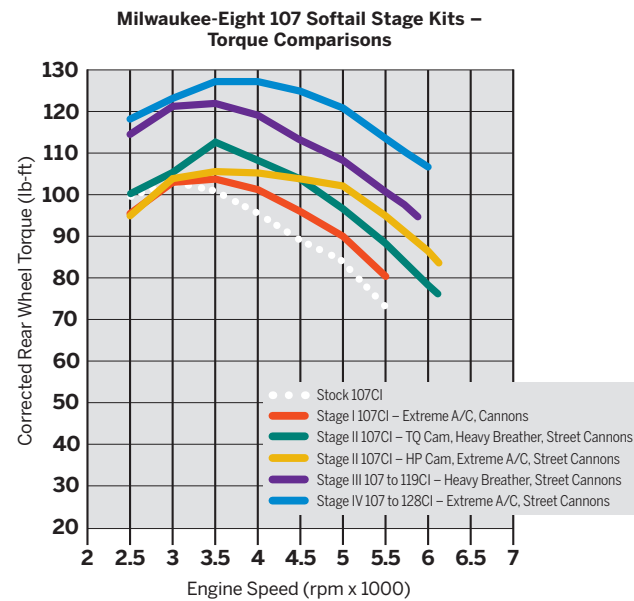
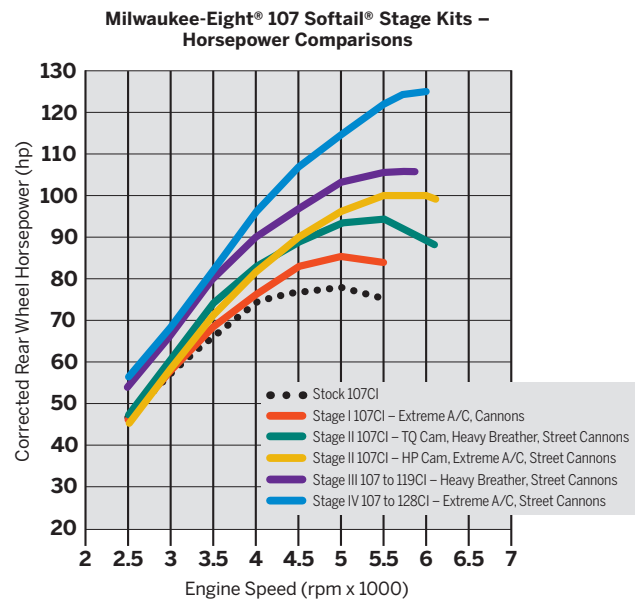

SOFTAIL 114CI MODEL STAGE UPGRADES

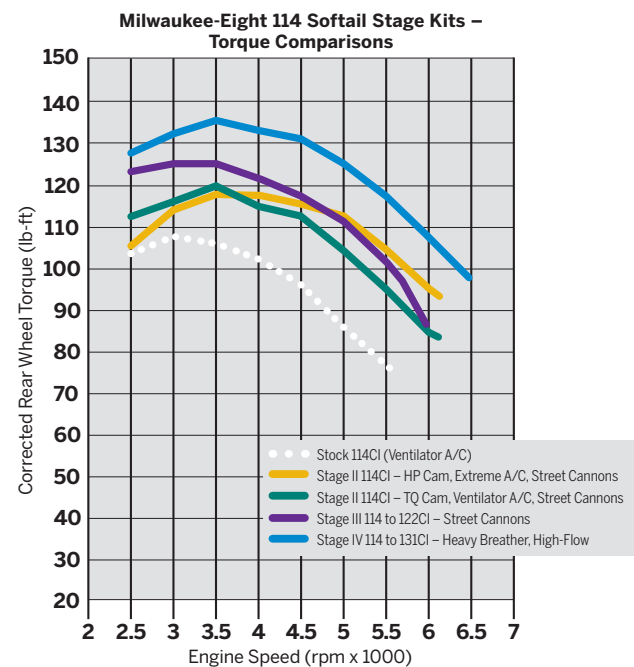
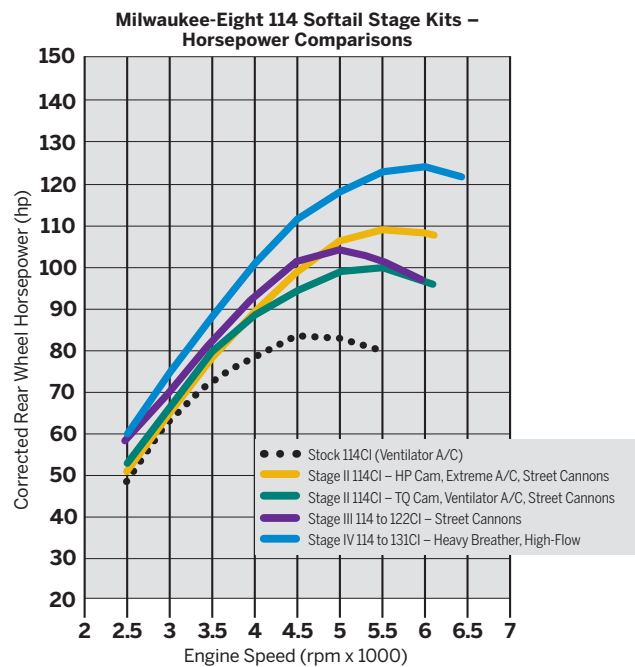

TOURING 107CI MODEL STAGE UPGRADES

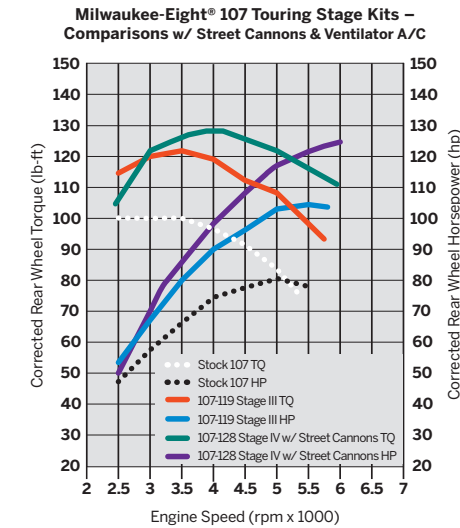

TOURING 114CI MODEL STAGE UPGRADES

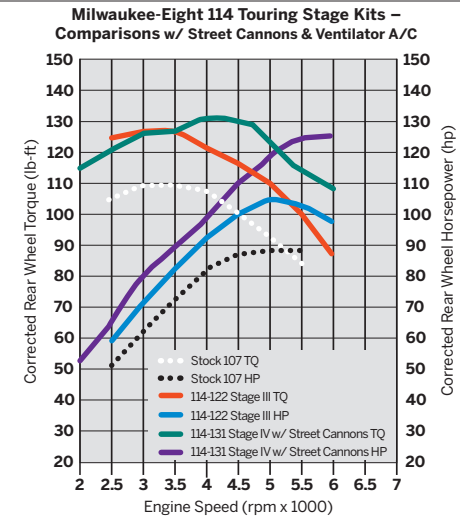

CVO™ TOURING MODEL STAGE UPGRADES

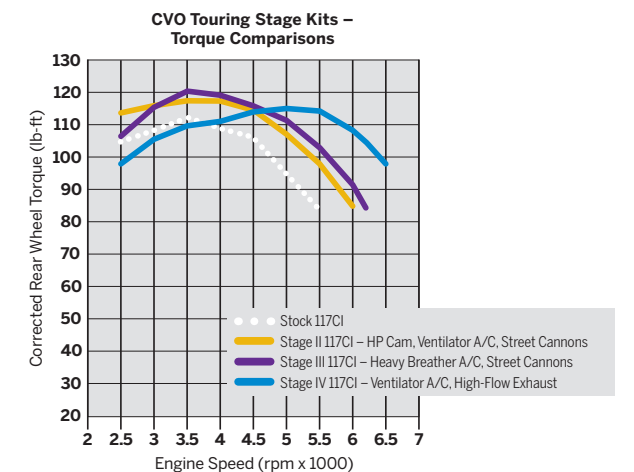
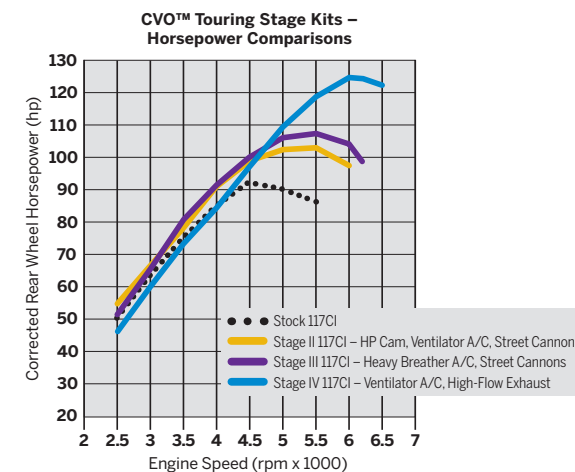

DYNAMOMETER (DYNO) PERFORMANCE TESTING: Declared performance values in this catalog represent SAE J-1349 transient peak power output. Dynamometer settings, motorcycle condition, variation, climate and other factors can affect performance output and results can vary from the performance values declared by Harley-Davidson.

Street legal and/or street compliant statements refer to product meeting 50-State emissions and noise standards in the United States. The street legal and/or street compliant statements may not apply to markets outside of the United States.

Street legal and/or street compliant statements refer to product meeting 50-State emissions and noise standards in the United States. The street legal and/or street compliant statements may not apply to markets outside of the United States.

338 SCREAMIN' EAGLE®

Milwaukee-Eight® Stage I Upgrade

A. SCREAMIN' EAGLE® HEAVY BREATHER EXTREME AIR CLEANER



We've taken the iconic Screamin' Eagle® Heavy Breather Air Cleaner to the next level—an extreme performance level. Designed for maximum performance, this extra-large Screamin' Eagle Heavy Breather Extreme Air Filter flows 42% more air than a traditional Heavy Breather filter. Air moves smoothly through the filter due to an interior bell-shape feature and then travels through a unique round to oval transitioned tube to improve leg clearance while providing unobstructed air to the throttle body. At speeds over 60 mph, the filter captures air from the front, forcing the air through a smaller area to create a RAM air effect, while the long intake tube enhances torque beyond other Ventilator and Round High-Flow Filters for enhanced acceleration. Designed to feed a large displacement engine enough clean air that can support output of over 150hp. The cast aluminum intake tube and back plate are dressed in rich, gloss black or mirror-like chrome. The back plate features a Screamin' Eagle logo. Kit includes all required mounting hardware. Optional Rain Sock P/N 29400424 is available to protect the exposed element in inclement weather.

Fits '18-later Softail®, '17-later Touring (except models equipped with Fairing Lower) and '17-later Freewheeler® models. Does not fit models equipped with Fairing Lower Glove Boxes, Fairing Lower Speakers or Road Glide® Fairing Spoilers. All models require ECM calibration with Screamin' Eagle Pro Street Tuner for proper installation. Pending approval for use in California on '21-'22 models. Refer to H-D.com/shop for status.

29400388	Chrome.	\$509.95
29400387	Gloss Black.	\$509.95



A. SCREAMIN' EAGLE HEAVY BREATHER EXTREME AIR CLEANER – CHROME



A. SCREAMIN' EAGLE HEAVY BREATHER EXTREME AIR CLEANER – GLOSS BLACK



A. SCREAMIN' EAGLE HEAVY BREATHER EXTREME AIR CLEANER – CHROME



A. SCREAMIN' EAGLE HEAVY BREATHER EXTREME AIR CLEANER – GLOSS BLACK

Street legal and/or street compliant statements refer to product meeting 50-State emissions and noise standards in the United States.

The street legal and/or street compliant statements may not apply to markets outside of the United States.

Notice: The prices appearing in this catalog are the manufacturer's suggested retail prices. Actual retail prices may vary.



B. SCREAMIN' EAGLE® HEAVY BREATHER ELITE AIR CLEANER - MILWAUKEE-EIGHT® ENGINE



B. SCREAMIN' EAGLE® HEAVY BREATHER ELITE AIR CLEANER - GLOSS BLACK



B. SCREAMIN' EAGLE® HEAVY BREATHER ELITE AIR CLEANER - CHROME

SCREAMIN' EAGLE® 339

Milwaukee-Eight® Stage I Upgrade

B. SCREAMIN' EAGLE® HEAVY BREATHER ELITE AIR CLEANER - MILWAUKEE-EIGHT® ENGINE



Take a deep breath. This Screamin' Eagle® Heavy Breather Elite picks up where the past generation Milwaukee-Eight Heavy Breather left off with a 15% air flow improvement. Redesigned to support even more performance with engine builds pushing over 135hp. The iconic Heavy Breather Air Cleaner features a forward-facing oiled cotton filter element that flows large volumes of clean air into the engine. The short, low profile cast tube rams the charge directly into the throttle body with little turbulence for increased power and torque, and the intake tube mounts to a custom back plate that features integral breathers and covers the throttle body electronics for a finished look. The slanted compact filter adds an aggressive performance look, and it is shaped to allow installation on Touring bikes equipped with fairing lowers. This Elite version includes an integrated cover manufactured from forged aluminum and precision machined to further enhance the stylized performance look while exposing a majority of the filter to maximize airflow. Available in your choice of chrome or gloss black finish, the kit includes filter, cover, intake tube, custom back plate, and all mounting hardware.

Fits '18-later Softail® models and '17-later Touring and Trike models. All models require ECM calibration with Screamin' Eagle Pro Street Tuner for proper installation. Does not fit on models equipped with fairing lower glove boxes or fairing lower speakers. Pending approval for use in California on '21-'22 models. Refer to H-D.com/shop for status.

29400406	Chrome.	\$584.95
29400407	Gloss Black.	\$584.95

Also available: SCREAMIN' EAGLE® HEAVY BREATHER ELITE AIR CLEANER - FILTER

K&N® replacement air filters are engineered to improve airflow for increased horsepower and quicker acceleration. K&N filters provide excellent filtration, and because they are washable and reusable, you can clean the filter whenever conditions demand. Designed as direct replacements for specified fitments.

29400405	\$83.95
-----------------	----------------

Fits '18-later Softail and '17-later Touring and Trike models equipped with Heavy Breather Elite Air Cleaner P/N 29400406 or 29400407.

Street legal and/or street compliant statements refer to products meeting EPA (49-State) and/or California (50-State) emissions and noise standards in the United States as specified.

The street legal and/or street compliant statements may not apply to markets outside of the United States.

Notice: The prices appearing in this catalog are the manufacturer's suggested retail prices. Actual retail prices may vary.

340 SCREAMIN' EAGLE®

Milwaukee-Eight® Stage I Upgrade

A. SCREAMIN' EAGLE® VENTILATOR EXTREME AIR CLEANER

Let it breathe! The open-face filter design of the Screamin' Eagle® Ventilator Extreme Air Cleaner Kit flows 39% more air than a traditional perimeter high-flow filter. When combined with an additional 1/2" of air filter thickness and the smooth radius die-cast back plate, this open filter can feed a large displacement engine with an unobstructed flow of clean air that can support output of over 150hp. Kit includes a die-cast back plate, and open-face, water-resistant, washable oiled-cotton filter element and all required installation gaskets and hardware. Optional Rain Sock P/N 29400412 is available to protect the exposed element in extreme weather. Choice of either Gloss Black (P/N 61300994) or Chrome (P/N 61300993) Cover Kit required to complete installation.

Fits '18-later Softail® and '17-later Touring and Trike models. Requires Ventilator Extreme Air Cleaner Cover Kit P/N 61300993 or 61300994 to complete installation. All models require ECM calibration with Screamin' Eagle Pro Street Tuner for proper installation, pending approval for use in California on '21-'22 models. Refer to H-D.com/shop for status.

29400396	Chrome.	\$247.95
29400397	Gloss Black.	\$247.95

B. SCREAMIN' EAGLE VENTILATOR EXTREME AIR CLEANER COVER

The Ventilator Extreme Air Cleaner Cover trims the face of the Screamin' Eagle Ventilator Extreme filter in style and features aggressive mounting lugs, polished stainless-steel custom ARP fasteners and an inset Screamin' Eagle medallion. The cast aluminum, rich gloss black cover wraps the leading edge of the filter element, covering the rubber gasket without restricting airflow. This Air Cleaner Cover is required to complete installation of the Ventilator Extreme Air Cleaner Kit P/N 29400396 & 29400397.

Fits Screamin' Eagle Ventilator Extreme Air Cleaner Kits P/N 29400396 and 29400397. Includes necessary ARP hardware. Also fits standard Ventilator Air Cleaner Kits P/N 29400298 and 29400299 with separate purchase of Extreme Ventilator Air Filter P/N 29400400.

61300993	Chrome.	\$199.95
61300994	Gloss Black.	\$199.95

C. SCREAMIN' EAGLE AIR CLEANER RAIN SOCK

Protect your exposed-element air cleaner during inclement weather. This mesh cover stretches over the filter to repel moisture that could damage the filter and be drawn into the engine. The breathable cover does not significantly reduce air flow to the engine.

29400412	\$23.95
-----------------	----------------

Fits Screamin' Eagle Ventilator Extreme Air Cleaner Kits.

D. SCREAMIN' EAGLE VENTILATOR EXTREME K&N® AIR FILTER ELEMENT

K&N® replacement air filters are engineered to improve airflow for increased horsepower and quicker acceleration. The Screamin' Eagle Extreme Ventilator K&N Air Filter Element is a replacement filter designed specifically for Screamin' Eagle Extreme Ventilator Air Cleaners. This replacement filter provides excellent filtration and because they are washable and reusable, you can clean the filter whenever conditions demand.

29400400	\$104.95
-----------------	-----------------

Fits Screamin' Eagle Ventilator and Ventilator Extreme Air Cleaner Kits. Requires Ventilator Extreme Air Cleaner Cover Kit P/N 61300993 or 61300994 to complete installation.



A. SCREAMIN' EAGLE VENTILATOR EXTREME AIR CLEANER – CHROME (SHOWN WITH CHROME COVER P/N 61300993)



A. SCREAMIN' EAGLE VENTILATOR EXTREME AIR CLEANER – GLOSS BLACK (SHOWN WITH GLOSS BLACK COVER P/N 61300994)



B. SCREAMIN' EAGLE VENTILATOR EXTREME AIR CLEANER COVER – CHROME



B. SCREAMIN' EAGLE VENTILATOR EXTREME AIR CLEANER COVER – GLOSS BLACK



C. SCREAMIN' EAGLE AIR CLEANER RAIN SOCK



D. SCREAMIN' EAGLE VENTILATOR EXTREME K&N AIR FILTER ELEMENT



E. SCREAMIN' EAGLE VENTILATOR AIR CLEANER KIT – MILWAUKEE-EIGHT – CHROME



E. SCREAMIN' EAGLE VENTILATOR AIR CLEANER KIT – MILWAUKEE-EIGHT – GLOSS BLACK



E. SCREAMIN' EAGLE VENTILATOR AIR CLEANER KIT – MILWAUKEE-EIGHT – BLACK



F. DEFIANCE COLLECTION VENTILATOR AIR CLEANER TRIM – MILWAUKEE-EIGHT – CHROME



F. DEFIANCE COLLECTION VENTILATOR AIR CLEANER TRIM – MILWAUKEE-EIGHT – GLOSS BLACK



F. DEFIANCE COLLECTION VENTILATOR AIR CLEANER TRIM – MILWAUKEE-EIGHT – GLOSS BLACK WITH HIGHLIGHTS



F. DEFIANCE COLLECTION VENTILATOR AIR CLEANER TRIM – MILWAUKEE-EIGHT

SCREAMIN' EAGLE® 341

Milwaukee-Eight® Stage I Upgrade

E. SCREAMIN' EAGLE® VENTILATOR AIR CLEANER KIT – MILWAUKEE-EIGHT® ENGINE

This low-profile oval air cleaner features an exposed filter element and a cast back plate designed to provide maximum airflow to the throttle body. This easy-to-install air cleaner produces significant performance gains, while the stylish cover is tapered for added leg clearance. This complete kit includes low-profile air cleaner cover, high-flow filter element, cast aluminum back plate, diamond-cut Screamin' Eagle® medallion and all required installation hardware. Protective Rain Sock is included. 50-State U.S. EPA compliant.

Fits '18-later Softail®, and '17-later Touring and Trike models. All models require ECM calibration with Screamin' Eagle Pro Street Tuner for proper installation. ECE compliant on '17-later CVO™ Touring models. Pending approval for use in California on '21-'22 models. Refer to H-D.com/shop for status.

29400299	Chrome.	\$319.95
29400298	Gloss Black.	\$319.95

F. DEFIANCE COLLECTION VENTILATOR AIR CLEANER TRIM – MILWAUKEE-EIGHT ENGINE

This forged and machined Defiance Air Cleaner Trim kit adds a premium touch to the Milwaukee-Eight® Ventilator Air Cleaner. The billet-style band with deep longitudinal lines and H-D logo wraps the center section of the Ventilator Air Cleaner face plate for a contemporary look. The Defiance Air Cleaner Trim is available in your choice of chrome, machine cut anodized black or full black finishes. Kit includes trim band and mounting hardware. Protective Rain Sock P/N 29400177 or 29762-09 is available separately.

Fits '18-later Softail, and '17-later Touring and Trike models equipped with Ventilator Air Cleaner P/N 29400298 or 29400299. Also fits '18-later Softail models with 114CI engines and '17-later CVO touring models with Original Equipment Ventilator Air Cleaner with separate purchase of Air Filter P/N 29400293.

61300768	Chrome.	\$144.95
61300769	Gloss Black Anodized.	\$144.95
61300770	Gloss Black with Highlights.	\$160.95

Street legal and/or street compliant statements refer to product meeting 50-State emissions and noise standards in the United States.

The street legal and/or street compliant statements may not apply to markets outside of the United States.

Notice: The prices appearing in this catalog are the manufacturer's suggested retail prices. Actual retail prices may vary.

Street legal and/or street compliant statements refer to product meeting 50-State emissions and noise standards in the United States.

The street legal and/or street compliant statements may not apply to markets outside of the United States.

Notice: The prices appearing in this catalog are the manufacturer's suggested retail prices. Actual retail prices may vary.

342 SCREAMIN' EAGLE®

Milwaukee-Eight® Stage I Upgrade

A. SCREAMIN' EAGLE® ROUND EXTREME-FLOW AIR CLEANER – CENTER BOLT

The open-face filter design of the Screamin' Eagle® Extreme-Flow Air Cleaner Kit provides 60% more filtered surface area to flow 11% more air than a traditional perimeter high-flow filter. When combined with the smooth radius die-cast back plate, this open filter can feed a large displacement engine with an unobstructed flow of clean air. While sized to fit behind Original Equipment or accessory center-bolt air cleaner covers, the deep open-face filter provides maximum airflow and style when paired with a matching open-face air cleaner trim option. Kit includes the gloss-black finished die-cast back plate with laser-engraved Screaming Eagle logo, an open-face washable oiled-cotton filter element, and all required installation gaskets and hardware. Optional Rain Sock P/N 29400363 is available to protect the exposed element in inclement weather. 50-State U.S. EPA compliant (except FL/SB).

29400357 Extreme Open-Face Filter. **\$219.95**
Fits '18-later Softail® and '17-later Touring and Trike models. '17-later Touring and Trike models require separate purchase of accessory round air cleaner cover or trim. Not compatible with air cleaner cover on CVO™ Touring models. All models require ECM calibration with Screamin' Eagle Pro Street Tuner for proper installation. Pending approval for use in California on '21-'22 models. Refer to H-D.com/shop for status.

B. SCREAMIN' EAGLE ROUND HIGH-FLOW AIR CLEANER – CENTER BOLT

The Screamin' Eagle High-Flow Air Cleaner Kit provides increased airflow to boost the power of your Milwaukee-Eight® engine equipped model. The one-piece cast back plate is system-matched to the throttle body to deliver a smooth uninterrupted flow, and shaped to permit air to enter around the entire perimeter of the air cleaner housing. The back plate is topped with a washable perimeter-flow oiled-cotton filter element that captures debris while passing significantly more air than the stock filter. This High Flow Air Cleaner can be dressed with most round Original Equipment or accessory center-bolt air cleaner covers. Or choose to flaunt your performance gains with the open element look, and finish it off with custom Air Cleaner Trim from one of the Harley-Davidson® decorative collections. This kit includes air cleaner element, gloss black back plate with laser-engraved Screaming Eagle logo, breather and all required hardware. Optional Rain Sock P/N 29400363 is available to protect the exposed element in inclement weather. 50-State U.S. EPA compliant.

29400355 **\$201.95**
Fits '18-later Softail and '17-later Touring and Trike models. '17-later Touring and Trike models require separate purchase of accessory round air cleaner cover or trim. Not compatible with air cleaner cover on CVO Touring models. All models require ECM calibration with Screamin' Eagle Pro Street Tuner for proper installation. Pending approval for use in California on '21-'22 models. Refer to H-D.com/shop for status.

C. SCREAMIN' EAGLE ROUND HIGH-FLOW AIR CLEANER – PERIMETER BOLT

Feed your engine more air while maintaining the fresh-from-the-factory look. Designed to accept the Original Equipment Softail perimeter-bolt air cleaner cover, this Screamin' Eagle High-Flow Air Cleaner Kit allows free breathing and unobstructed airflow to your Milwaukee-Eight engine. The die-cast back plate is sized to permit airflow around the entire perimeter of the air cleaner. Your engine gets more air, and you feel more power throughout the rev range. The back plate features 5 threaded lugs that accept the perimeter-bolt air cleaner cover, and a chamfered throat that allows smooth flow into the throttle body. The kit includes the gloss-black finished die-cast back plate, a perimeter-flow washable oiled-cotton filter element, all required installation gaskets and hardware and a laser-engraved Screamin' Eagle logo to finish the look. Optional Rain Sock P/N 29400363 is available to protect the exposed element in inclement weather. 50-State U.S. EPA compliant.

29400356 **\$201.95**
Fits '18-later FLFB, FL/SB, FXBB, FXBR, FXBRS and FXFB and '18-'19 FXBRS models with Original Equipment perimeter-bolt air cleaner cover. Not recommended for use with center-bolt air cleaner covers or trim. All models require ECM calibration with Screamin' Eagle Pro Street Tuner for proper installation. Pending approval for use in California on '21-'22 models. Refer to H-D.com/shop for status.

Street legal and/or street compliant statements refer to product meeting 50-State emissions and noise standards in the United States.

The street legal and/or street compliant statements may not apply to markets outside of the United States.



AIR CLEANER FILTER ELEMENT COMPARISON

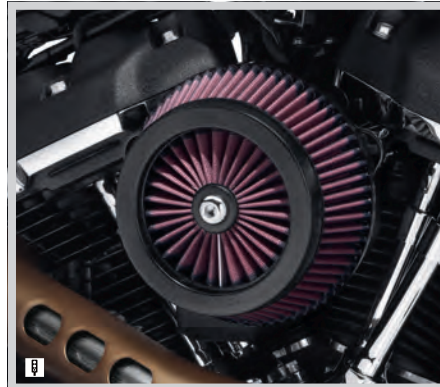

A. SCREAMIN' EAGLE ROUND EXTREME-FLOW AIR CLEANER – CENTER BOLT



B. SCREAMIN' EAGLE ROUND HIGH-FLOW AIR CLEANER – CENTER BOLT

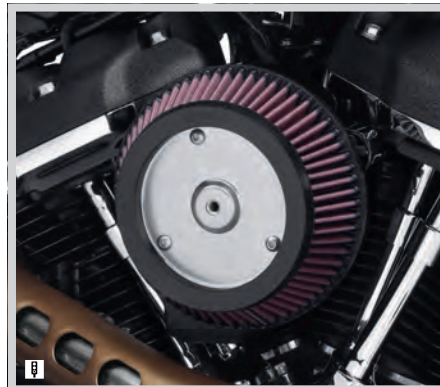

C. SCREAMIN' EAGLE ROUND HIGH-FLOW AIR CLEANER – PERIMETER BOLT



D. SCREAMIN' EAGLE ROUND AIR CLEANER COVER – RATCHET



E. SCREAMIN' EAGLE ROUND AIR CLEANER COVER – CALIBRE



F. AIR CLEANER TRIM KITS – BRASS COLLECTION



F. AIR CLEANER TRIM KITS – DARK CUSTOM



F. AIR CLEANER TRIM KITS – #1 SKULL



F. AIR CLEANER TRIM KITS – WILLIE G SKULL – CHROME



F. AIR CLEANER TRIM KITS – AIRFLOW



F. AIR CLEANER TRIM KITS – LIVE TO RIDE

SCREAMIN' EAGLE® 343

High-Flow Round Air Cleaner Covers

D. SCREAMIN' EAGLE® ROUND AIR CLEANER COVER – RATCHET

The Ratchet Air Cleaner Cover trims the face of the Screamin' Eagle® Round Air Cleaner filter in style. Ideal for use with Extreme open face filters, the forged aluminum cover wraps the leading edge of the filter element, covering the rubber gasket without restricting the airflow. The Ratchet Cover is finished in rich black, and features a center bar with Screamin' Eagle script and a lugged outer ring. The kit includes a black filler plate to cover the unfinished face of standard High Flow filter for a clean blacked-out appearance.

61300845 **\$175.95**
Fits '18-later Softail® and '17-later Touring and Trike models equipped with Screamin' Eagle round High Flow Air Cleaner.

E. SCREAMIN' EAGLE ROUND AIR CLEANER COVER – CALIBRE

The unique open slot design of the Calibre Air Cleaner Cover maximizes style without compromising performance. Ideal for use with Extreme open face filters, the forged aluminum cover wraps the leading edge of the filter element, covering the rubber gasket without restricting the airflow. The gloss black Calibre Cover features 3 radiused slots cut into the face and a Screamin' Eagle logo prominently on display. The kit includes a black filler plate to cover the unfinished face of standard High Flow filter for a clean blacked-out appearance.

61300846 **\$160.95**
Fits '18-later Softail and '17-later Touring and Trike models equipped with Screamin' Eagle round High Flow Air Cleaner.

F. AIR CLEANER TRIM KITS

The perfect blend of performance and style. Available in a wide variety of styles, this bolt-on Air Cleaner Trim is sized to cover the face of most Screamin' Eagle Round High-Flow Air Cleaners. You can continue the look of your custom collection while maximizing air flow to the engine. Model-specific rain socks are available to protect the open element during inclement weather.

Fits Evolution® 1340 models, '99-'08 Dyna®, '00-'15 Softail (except FLS, FL/SB, FL/SB, and FXS) and '99-'13 Touring and Trike models equipped with oval-shaped Original Equipment air cleaner cover. Also fits models equipped with Screamin' Eagle Round High-Flow Air Cleaner Kits with separate purchase of Rain Sock Kit P/N 28728-10 or Air Cleaner Trim Installation Kit P/N 12400158.

61400339	Brass Collection.	\$163.95
61300057	Dark Custom™ Collection.	\$124.95
27956-10	Number One Skull Collection.	\$58.95
29400366	Willie G Skull – Black.	\$54.95
29417-04	Willie G Skull – Chrome.	\$54.95
61400323	Airflow Collection.	\$64.95
29328-99	Live To Ride Collection – Gold.	\$54.95

Also available: (not shown)
SCREAMIN' EAGLE AIR CLEANER RAIN SOCK
Protect your exposed-element air cleaner during inclement weather. This mesh cover stretches over the filter to repel moisture that could damage the filter and be drawn into the engine. The breathable cover does not significantly reduce air flow to the engine.

29400363 For Round High-Flow Filter. **\$33.95**
Fits '18-later Softail and '17-later Touring and Trike models equipped with Screamin' Eagle High-Flow Air Cleaners with round perimeter flow air cleaner element.

29493-05A For Heavy Breather Filter. **\$28.95**
Fits models equipped with Screamin' Eagle Heavy Breather Air Cleaner Kits (except Compact Heavy Breather P/N 28716-10, Heavy Breather Elite P/N 29400173, 29400172 or 29400285, and Milwaukee-Eight® Heavy Breather P/N 29400263 or 29400264).

Street legal and/or street compliant statements refer to product meeting 50-State emissions and noise standards in the United States.

The street legal and/or street compliant statements may not apply to markets outside of the United States.

Notice: The prices appearing in this catalog are the manufacturer's suggested retail prices. Actual retail prices may vary.

344 SCREAMIN' EAGLE®

Round Air Cleaner Covers

120TH ANNIVERSARY DECORATIVE COMPONENTS

Celebrate 120 years of Harley-Davidson® pride and craftsmanship. This easy-to-install accessory trim is also standard equipment on the limited-edition Harley-Davidson® 120th Anniversary models. Handsome red fade finish with subtle gold and black accents.

A. 120TH ANNIVERSARY AIR CLEANER TRIM – STANDARD

Gloss Red fade finish that indicates 114 cubic inch displacement.

61301326 **\$49.95**

Fits '17-later Touring and Trike models with Original Equipment wedge shaped air cleaner cover. Does not fit CVO™ models.

B. 120TH ANNIVERSARY AIR CLEANER TRIM – VENTILATOR

Gloss Red fade finish that indicates 114 cubic inch displacement.

61301327 **\$49.95**

Fits '18-later Softail® and '17-later Touring and Trike models equipped with Ventilator Air Cleaner P/N 29400298 or 29400299. Also fits '18-later Softail models with 114CI engines and '17-later CVO touring models with Original Equipment Ventilator Air Cleaner with separate purchase of Air Filter P/N 29400293.

C. AIR CLEANER TRIM – BRUSHED ALUMINUM

Show off your Milwaukee-Eight® engine's displacement with pride. Available for 107- and 114-cubic-inch engines, this brushed aluminum and black trim is the perfect complement to chrome or black engine finishes. This easy-to-install self-adhesive formed aluminum trim fits perfectly into the recessed face of the Softail models Original Equipment perimeter bolt air cleaner cover.

61300788 107 Logo. **\$48.95**

Fits '18-later FLFB, FLSB, FXBB, FXBR and FXFB models with Original Equipment perimeter bolt air cleaner cover.

D. BOBBER-STYLE ROUND AIR CLEANER COVER

Low-profile round air cleaner cover adds an attractive nostalgic look to any bike's profile. This cover can be accented with your choice of stylish air cleaner trim collections (sold separately) for a personalized look. The cover features a cut-away bottom design that exposes the filter element to maximize the airflow when installed with a Screamin' Eagle® High-Flow Air Cleaner Kit.

Fits '12-'16 XL1200V and '11-'15 FLS and FXS models with Original Equipment round air cleaner. Also fits models equipped with Screamin' Eagle Round High-Flow Air Cleaner Kits.

61300120 Chrome. **\$59.95**

61300128 Gloss Black. **\$59.95**



A. 120TH ANNIVERSARY AIR CLEANER TRIM – STANDARD



B. 120TH ANNIVERSARY AIR CLEANER TRIM – VENTILATOR



E. SCREAMIN' EAGLE WEDGE HIGH-FLOW AIR CLEANER



C. AIR CLEANER TRIM – BRUSHED ALUMINUM



E. SCREAMIN' EAGLE WEDGE HIGH-FLOW AIR CLEANER – CHROME



E. SCREAMIN' EAGLE WEDGE HIGH-FLOW AIR CLEANER – BLACK



D. BOBBER-STYLE ROUND AIR CLEANER COVER – CHROME



D. BOBBER-STYLE ROUND AIR CLEANER COVER – GLOSS BLACK



F. MILWAUKEE-EIGHT ENGINE AIR CLEANER COVER – GLOSS BLACK

SCREAMIN' EAGLE® 345

Milwaukee-Eight® Stage I Upgrade

E. SCREAMIN' EAGLE® WEDGE HIGH-FLOW AIR CLEANER

Screamin' Eagle® High-Flow Air Cleaner Kits allow free breathing and unobstructed airflow to your Milwaukee-Eight® engine—while maintaining a subtle Original Equipment look. These kits feature a die-cast back plate sized to provide an open-element function that permits airflow around the entire perimeter of the air cleaner and through the ram air opening at the front. Your engine gets more air, and you feel more power throughout the rev range. Kit includes the die-cast back plate, a high-flow oiled-cotton filter element, all required installation gaskets and hardware and a diamond-cut Screamin' Eagle medallion to finish the look. Kits are available with your choice of chrome or textured black back plate to match your customizing style. 50-State U.S. EPA compliant.

Fits '17-later Touring and Trike models equipped with wedge style air cleaner. Not compatible with air cleaner cover on CVO™ Touring models. All models require ECM calibration with Screamin' Eagle Pro Street Tuner for proper installation. ECE compliant on '17-later CVO Touring models. Pending approval for use in California on '21-'22 models. Refer to H-D.com/shop for status.

29400246A Chrome. **\$196.95**

29400245A Black. **\$185.95**

Also available:

SCREAMIN' EAGLE AIR CLEANER MEDALLION – MILWAUKEE-EIGHT

Dress your factory air cleaner cover with a diamond-cut Screamin' Eagle medallion. Lock patch holds the medallion firmly in place and is easy to remove for access to the air cleaner hardware.

61300762 **\$23.95**

Fits '17-later Touring and Trike models equipped with Original Equipment wedge air cleaner cover. Does not fit CVO models.

F. MILWAUKEE-EIGHT® ENGINE AIR CLEANER COVER – GLOSS BLACK

Complete the blacked-out look. This Gloss Black Air Cleaner Cover adds a sinister touch without changing the signature profile of your Milwaukee-Eight engine.

61300828 **\$74.95**

Fits '17-later Touring (except CVO) and Trike models with Original Equipment wedge style air cleaner or Screamin' Eagle Wedge High-Flow Air Cleaner.

Street legal and/or street compliant statements refer to product meeting 50-State emissions and noise standards in the United States.

The street legal and/or street compliant statements may not apply to markets outside of the United States.

Notice: The prices appearing in this catalog are the manufacturer's suggested retail prices. Actual retail prices may vary.

Street legal and/or street compliant statements refer to product meeting 50-State emissions and noise standards in the United States.

The street legal and/or street compliant statements may not apply to markets outside of the United States.

Notice: The prices appearing in this catalog are the manufacturer's suggested retail prices. Actual retail prices may vary.

346 SCREAMIN' EAGLE®

Milwaukee-Eight® Stage I Upgrade

A. SCREAMIN' EAGLE® HIGH-FLOW EXHAUST SYSTEM – SOFTAIL MODELS

The Screamin' Eagle® High-Flow Exhaust for Softail® models provides bolt-on performance by reducing the catalyst restrictions and improving exhaust flow. This High-Flow Exhaust is optimized for use with the Screamin' Eagle 128/131 Stage IV Kits or 131 Crate Engine equipped for Softail models with Milwaukee-Eight® engine. Maximize the horsepower and torque of your performance build when your bike needs it most, all while reducing the weight of your exhaust system by over 20 percent. Offered in durable Satin Black or Stainless finishes to complement your customization journey. Go ahead, let it rip!

- Replaces the stock head pipe and mufflers with large diameter, free-flowing head pipes and matching muffler.
- Mandrel-bent and TIG welded stainless steel headers are meticulously assembled with race shop precision for perfect fitment on your motorcycle.
- Maintains flat torque curve from cruising RPM to redline.
- 2-into-1 full exhaust system reduces weight and provides serious performance look.
- Pre-tapped for stock or wide-band O2 sensors for easy, emissions-compliant installation.
- Dial system to motorcycle by using the Screamin' Eagle Street Performance Tuner to tune ECM specifically to match performance upgrades.

49-State U.S. EPA Compliant on select '18-later Softail models. Refer to www.H-D.com/Shop for status.

Fits '18-later Softail models (except FXDRS, FLFB, FLFBS, FXBR, and FXBRS). Compliant 49-State, Canada, Australia, and New Zealand. Also fits '18-20 Softail models sold in Mexico. Does not fit California models.

64900828	Satin Black.	\$1,380.95
64900829	Stainless.	\$1,433.95



A. SCREAMIN' EAGLE HIGH-FLOW EXHAUST SYSTEM – SOFTAIL MODELS



A. SCREAMIN' EAGLE® SOFTAIL® MODEL HIGH-FLOW EXHAUST SYSTEM – SOFTAIL MODELS, SATIN BLACK



A. SCREAMIN' EAGLE® SOFTAIL® MODEL HIGH-FLOW EXHAUST SYSTEM – SOFTAIL MODELS, STAINLESS

NOTE: There is no warranty on exhaust pipes and mufflers with regard to any discoloration. Blueing is caused by tuning characteristics, cam timing, carburetor jetting, over-heating, etc. and is not caused by defective manufacturing.

Street legal and/or street compliant statements refer to product meeting 50-State emissions and noise standards in the United States.

The street legal and/or street compliant statements may not apply to markets outside of the United States.

Notice: The prices appearing in this catalog are the manufacturer's suggested retail prices. Actual retail prices may vary.



B. SCREAMIN' EAGLE STREET CANNON MUFFLERS – CHROME, SHORT (SHOWN ON SOFTAIL DELUXE MODEL)



B. SCREAMIN' EAGLE STREET CANNON MUFFLERS – CHROME, LONG (SHOWN ON FAT BOY MODEL)



B. STANDARD CHROME MUFFLER END CAPS (INCLUDED WITH STREET CANNON MUFFLERS)



C. SCREAMIN' EAGLE SATIN BLACK MUFFLER END CAPS

SCREAMIN' EAGLE® 347

Milwaukee-Eight® Stage I Upgrade

B. SCREAMIN' EAGLE® STREET CANNON MUFFLERS – CHROME

Call attention to your ride without calling attention to your ride. Tuned to provide a deep bass exhaust note and great rumble throughout the RPM range, these 3.5" Street Cannon mufflers deliver the famous Harley sound while preserving the peace with your neighbors. You get a nice bark when you get on the throttle, and a deep mellow tone when cruising at constant speed. The tuned baffles work with the internal high-flow catalyst to strike the perfect balance required to deliver performance that you can feel in your gut. The large 3.5" diameter Street Cannons provide free flow of exhaust gases with just the right amount of back pressure for a smooth-running ride. Mufflers include matching chrome end caps with subtle engraved Screamin' Eagle® logo. Looking to black out your ride? Optional satin black wrap-around muffler shields and end caps are available to complete the look.

64900636 Short – Domestic. **\$584.95**
Fits '18-later FLDE, FLHC and FLHCS models. Includes chrome muffler end caps. Installation requires separate purchase of Muffler Clamps P/N 65900012 (Qty 2) and Exhaust Gaskets P/N 65900017 (Qty 2). All models require ECM calibration with Screamin' Eagle Pro Street Tuner (sold separately). Pending approval for use in California on '21-'22 models. Refer to H-D.com/shop for status.

64901192 Short – ECE Certified. **\$1,050.95**
Designed for International markets that require ECE certified mufflers. Fits '21-later FLDE, FLHC and FLHCS models. Includes chrome muffler end caps. Installation requires separate purchase of Muffler Clamps P/N 65900012 (Qty 2) and Exhaust Gaskets P/N 65900017 (Qty 2).

64900638 Short – ECE Certified. **\$822.95**
Designed for International markets that require ECE certified mufflers. Fits '18-'20 FLDE, FLHC and FLHCS models. Includes chrome muffler end caps. Installation requires separate purchase of Muffler Clamps P/N 65900012 (Qty 2) and Exhaust Gaskets P/N 65900017 (Qty 2).

64900690 Long – Domestic. **\$584.95**
Fits '18-later FLFB, FLFBS, FLFL, FXBB, FXBBS, FXBR, FXBRS, FXLR, FXLRS, FXLRST and FXST models. Includes chrome muffler end caps. Installation requires separate purchase of Muffler Clamps P/N 65900012 (Qty 2) and Exhaust Gaskets P/N 65900017 (Qty 2). All models require ECM calibration with Screamin' Eagle Pro Street Tuner (sold separately). Pending approval for use in California on '21-'22 models. Refer to H-D.com/shop for status.

64901193 Long – ECE Certified. **\$1,050.95**
Designed for International markets that require ECE certified mufflers. Fits '21-later FLFB, FLFBS, FLFL, FXBB, FXBBS, FXBR, FXBRS, FXLR, FXLRS, FXLRST and FXST models. Includes chrome muffler end caps. Installation requires separate purchase of Muffler Clamps P/N 65900012 (Qty 2) and Exhaust Gaskets P/N 65900017 (Qty 2).

64900691 Long – ECE Certified. **\$822.95**
Designed for International markets that require ECE certified mufflers. Fits '18-'20 FLFB, FLFBS, FLFL, FXBB, FXBBS, FXBR, FXBRS, FXLR, FXLRS, FXLRST and FXST models. Includes chrome muffler end caps. Installation requires separate purchase of Muffler Clamps P/N 65900012 (Qty 2) and Exhaust Gaskets P/N 65900017 (Qty 2).

C. MUFFLER END CAPS – 3.5" SATIN BLACK

These easy-to-install caps allow you to finish your Softail® 3.5" Screamin' Eagle Street Cannon mufflers your way. Sold in pairs these Satin Black end caps feature a subtle engraved Screamin' Eagle script for a clean look. Installation hardware included.

65100153 **\$118.95**
Fits '18-later Softail models equipped with Screamin' Eagle Street Cannon Mufflers P/N 64900636, 64900638, 64900690 or 64900691.

NOTE: There is no warranty on exhaust pipes and mufflers with regard to any discoloration. Blueing is caused by tuning characteristics, cam timing, carburetor jetting, over-heating, etc. and is not caused by defective manufacturing.

Street legal and/or street compliant statements refer to product meeting 50-State emissions and noise standards in the United States.

The street legal and/or street compliant statements may not apply to markets outside of the United States.

Notice: The prices appearing in this catalog are the manufacturer's suggested retail prices. Actual retail prices may vary.

SCREAMIN' EAGLE

348 SCREAMIN' EAGLE®

Milwaukee-Eight® Stage I Upgrade

A. SCREAMIN' EAGLE® STREET CANNON MUFFLERS – SPORT GLIDE® MODELS

Tuned to provide a deep bass exhaust note and great rumble throughout the RPM range, this 4.5" Street Cannon muffler delivers the famous Harley sound while preserving the peace with your neighbors. You get a nice bark when you get on the throttle, and a deep mellow tone when cruising at constant speed. The tuned baffle works with the internal high-flow catalyst to strike the perfect balance required to deliver performance that you can feel in your gut. The large 4.5" diameter Street Cannon provides free flow of exhaust gases with just the right amount of back pressure for a smooth-running ride and can be fitted with a wide variety of styled muffler end caps to provide the perfect finishing touch. Requires choice of chrome or satin black muffler shield with laser etched logo.

Fits '18-later FLSB models. Installation requires separate purchase of Muffler Shield, Muffler End Cap, Muffler Clamp P/N 65900007 (Qty 1) and Muffler Gasket P/N 65900040 (Qty 1). Requires ECM calibration with Screamin' Eagle® Pro Street Tuner (sold separately). Pending approval for use in California on '21 models. Refer to H-D.com/shop for status.

64900752	Chrome.	\$452.95
64900754	Black.	\$509.95

Designed for International markets that require ECE certified mufflers. Fits '21-later FLSB models. Installation requires separate purchase of Muffler Shield, Muffler End Cap, Muffler Clamp P/N 65900007 (Qty 1) and Muffler Gasket P/N 65900040 (Qty 1).

64901190	Chrome,	\$788.95
64901191	Black,	\$788.95

Designed for International markets that require ECE certified mufflers. Fits '18-'20 FLSB models. Installation requires separate purchase of Muffler Shield, Muffler End Cap, Muffler Clamp P/N 65900007 (Qty 1) and Muffler Gasket P/N 65900040 (Qty 1).

64900756	Chrome, ECE	\$700.95
64900758	Black, ECE	\$765.95

Shown with: MUFFLER SHIELD

Styled to hug the lines of the uniquely shaped stepped muffler design of the Screamin' Eagle Street Cannon for Sport Glide® models. Offered in both chrome and satin black and feature a subtle engraved Screamin' Eagle script for a clean look.

Fits '18-later FLSB models equipped with Screamin' Eagle Street Cannon Mufflers P/Ns 64900752, 64900754, 64900756, 64900758.

65400466	Chrome.	\$69.95
65400468	Black.	\$79.95

B. MUFFLER END CAPS – 4.5"

Fits '18-later FLSB and '17-later Touring models equipped with 4.5" Screamin' Eagle Street Cannon Mufflers. Does not fit CVO™ Touring mufflers. Sold Individually.

1. 65100165	Slash Cut – Chrome.	\$59.95
2. 65100166	Slash Cut – Black.	\$59.95
3. 65100216	Empire – Chrome.	\$122.95
4. 65100217	Empire – Black.	\$122.95
5. 65100218	Empire – Machine Cut.	\$122.95
6. 65100160	Two-Piece – Chrome.	\$90.95
7. 65100161	Two-Piece – Black.	\$90.95

NOTE: There is no warranty on exhaust pipes and mufflers with regard to any discoloration. Blueing is caused by tuning characteristics, cam timing, carburetor jetting, over-heating, etc. and is not caused by defective manufacturing.

Street legal and/or street compliant statements refer to product meeting 50-State emissions and noise standards in the United States.

The street legal and/or street compliant statements may not apply to markets outside of the United States.

Notice: The prices appearing in this catalog are the manufacturer's suggested retail prices. Actual retail prices may vary.



A. SCREAMIN' EAGLE STREET CANNON MUFFLERS – SPORT GLIDE MODELS, BLACK (SHOWN WITH BLACK MUFFLER SHIELD)



A. SCREAMIN' EAGLE STREET CANNON MUFFLERS – SPORT GLIDE MODELS, CHROME (SHOWN WITH CHROME MUFFLER SHIELD)



B. MUFFLER END CAPS



C. SATIN BLACK MUFFLER SHIELDS – SHORT (SHOWN ON FLHC MODEL WITH SATIN BLACK EXHAUST SHIELDS)



D. SATIN BLACK EXHAUST SHIELD KITS



D. SATIN BLACK EXHAUST SHIELD KIT



D. SATIN BLACK COLLECTOR SHIELD – FAT BOB MODELS

SCREAMIN' EAGLE® 349

Milwaukee-Eight® Stage I Upgrade

C. SATIN BLACK MUFFLER SHIELDS

Complete the blacked-out look. These rich satin-black shields wrap the chrome Street Cannon mufflers and complete the conversion to a sinister look. Styled to hug the lines of the mufflers, the blunt-cut shields are sized to expose the muffler end cap for a custom touch. Easy-to-install kit includes front and rear shields and black mounting clamps.

65400457	Short Shields.	\$139.95
Fits '18-later FLDE, FLHC and FLHCS models equipped with Screamin' Eagle® Street Cannon Mufflers P/N 64900636 or 64900638.		

65400461	Long Shields.	\$139.95
Fits '18-later FLFB, FLFBS, FLFL, FXBB, FXBBS, FXBR, FXBRS, FXLR, FXLRS, FXLRST and FXST models equipped with Screamin' Eagle® Street Cannon Mufflers P/N 64900690 or 64900691.		

D. SATIN BLACK EXHAUST SHIELD KIT

Extend the custom look along the bike's entire profile. These formed steel exhaust shields are available in a unique satin black ceramic finish that complements black Screamin' Eagle Street Cannon Muffler Shields. This exhaust shield kit has survived stringent Harley-Davidson testing for durability and corrosion resistance. Manufactured to Original Equipment standards for exact fit, the easy-to-install kit includes front and rear head pipe shields.

65400458	Collector Shield.	\$213.95
Fits '18-later FLDE, FLHC and FLHCS models.		

65400459	Collector Shield.	\$213.95
Fits '18-later FLFL, FXLR and FXST models.		

65400460	Collector Shield.	\$213.95
Fits '18-later FLFB, FLFBS, FXBR and FXBRS models.		

65400472	Collector Shield.	\$180.95
Fits '18-later FLFB, FXFB, FXFBS and '19-'20 FXDRS models.		

65400480	Collector Shield.	\$79.95
Fits '18-'20 FLSB models.		

65400481	Collector Shield.	\$107.95
Fits '18-later FXFB and FXFBS models.		

NOTE: There is no warranty on exhaust pipes and mufflers with regard to any discoloration. Blueing is caused by tuning characteristics, cam timing, carburetor jetting, over-heating, etc. and is not caused by defective manufacturing.

Street legal and/or street compliant statements refer to product meeting 50-State emissions and noise standards in the United States.

The street legal and/or street compliant statements may not apply to markets outside of the United States.

Notice: The prices appearing in this catalog are the manufacturer's suggested retail prices. Actual retail prices may vary.

350 SCREAMIN' EAGLE®

Milwaukee-Eight® Stage I Upgrade

A. SCREAMIN' EAGLE® STREET CANNON PERFORMANCE SLIP-ON MUFFLERS – 4.5" E

Dialed in to enhance the performance of the Milwaukee-Eight® engine, these slip-on mufflers feature a large inlet for improved airflow. When teamed with a free-flowing air cleaner, these Street Cannon mufflers deliver horsepower and torque gains you can feel. The large 4.5" diameter mufflers are tuned to provide a rich exhaust note, a deep bass rumble and great throaty sound when you roll on the throttle. But to strike a balance with your neighbors, the large internal volume and strategically designed baffles help maintain the peace at partial throttle. The large-diameter body adds a muscular look to your ride, and the newly designed mounts keep the mufflers tucked in close to the bags for a clean profile and can be fitted with a wide variety of styled muffler end caps to provide the perfect finishing touch.

Fits '17-later Touring models. Does not fit Trike models. Installation requires separate purchase of Muffler Clamps P/N 65900012 and 65900015. Requires separate purchase of end caps. All models require ECM calibration with Screamin' Eagle® Pro Street Tuner for proper installation. Pending approval for use in California on '21-'22 models. Refer to H-D.com/shop for status.

64900552A	Chrome.	\$649.95
64900553B	Satin Black.	\$649.95

Fits '21-later Touring Models. Does not fit Trike models. Designed for International markets that require ECE-certified mufflers. Include matching Two-Piece Muffler end caps. Installation requires separate purchase of Muffler Clamps P/N 65900012 and 65900015.

64901208	Chrome.	\$1,365.95
64901205	Satin Black.	\$1,365.95

Fits '17-'20 Touring models. Does not fit Trike models. Designed for International markets that require ECE certified mufflers. Includes matching Two-piece Muffler end caps. Installation requires separate purchase of Muffler Clamps P/N 65900012 and 65900015.

64900555A	Chrome – ECE Certified.	\$899.95
64900554B	Satin Black – ECE Certified.	\$899.95

B. SATIN BLACK EXHAUST SHIELD KIT

These formed steel exhaust shields feature a unique black coating that complements the finish of the Screamin' Eagle black slip-on mufflers. The rich black coating maintains its uniform black finish and has survived stringent Harley-Davidson testing for durability and corrosion resistance. Manufactured to Original Equipment standards for exacting fit, the easy-to-install kit includes front and rear head pipe shields.

65400285A	\$266.95
------------------	-----------------

Fits '17-later Touring and Trike models.



A. SCREAMIN' EAGLE STREET CANNON PERFORMANCE SLIP-ON MUFFLERS – 4.5" – CHROME (SHOWN WITH CHROME TWO-PIECE END CAPS)



A. SCREAMIN' EAGLE STREET CANNON PERFORMANCE SLIP-ON MUFFLERS – 4.5" – SATIN BLACK (SHOWN WITH SATIN BLACK TWO-PIECE END CAPS)



B. SATIN BLACK EXHAUST SHIELD KIT

NOTE: There is no warranty on exhaust pipes and mufflers with regard to any discoloration. Blueing is caused by tuning characteristics, cam timing, carburetor jetting, over-heating, etc. and is not caused by defective manufacturing.

Street legal and/or street compliant statements refer to product meeting 50-State emissions and noise standards in the United States.

The street legal and/or street compliant statements may not apply to markets outside of the United States.

Notice: The prices appearing in this catalog are the manufacturer's suggested retail prices. Actual retail prices may vary.



C. TWO-PIECE MUFFLER END CAP KIT – 4.5" – CHROME



C. TWO-PIECE MUFFLER END CAP KIT – 4.5" – SATIN BLACK



D. MUFFLER END CAP KIT – 4.5" – BLUNT - STAINLESS



D. MUFFLER END CAP KIT – 4.5" – SLASH UP/DOWN - GLOSS BLACK



E. EMPIRE COLLECTION MUFFLER END CAP KIT – CHROME



E. EMPIRE COLLECTION MUFFLER END CAP KIT – MACHINE CUT



E. EMPIRE COLLECTION MUFFLER END CAP KIT – SATIN BLACK



E. EMPIRE COLLECTION MUFFLER END CAPS



F. BLUNT SLASH UP/DOWN/OUT MUFFLER END CAP KIT – 4.5" – CHROME



F. BLUNT SLASH UP/DOWN/OUT MUFFLER END CAP KIT – 4.5" – SATIN BLACK

SCREAMIN' EAGLE® 351

Milwaukee-Eight® Stage I Upgrade

C. TWO-PIECE MUFFLER END CAP KIT – 4.5"

Shaped to provide a complete finishing touch to the rear of your bike, these slash-cut end caps feature a reverse cone rolled edge for a massive solid billet look. The reverse cone opening hugs the internal slotted flash suppressor-inspired barrel for a weapons-grade style.

Fits '17-later Touring models equipped with 4.5" Screamin' Eagle® Street Cannon Mufflers and Screamin' Eagle High-Flow Exhaust Systems with 4.5" Street Cannon Mufflers.

65100078	Chrome.	\$199.95
65100076A	Satin Black.	\$199.95

D. MUFFLER END CAP KIT – 4.5"

These easy-to-install performance end caps allow you to finish your 4.5" Screamin' Eagle Street Cannon mufflers your way. Sold in pairs. Installation hardware included.

Fits '17-later Touring models equipped with 4.5" Screamin' Eagle Street Cannon Mufflers and Screamin' Eagle High-Flow Exhaust Systems with 4.5" Street Cannon Mufflers.

65100196	Blunt/Stainless Steel.	\$160.95
65100205	Slash Up/Down/Out-Gloss Black.	\$191.95

E. EMPIRE COLLECTION MUFFLER END CAP KIT - 4.5"

Executed in durable cast and billet aluminum, these Empire™ Collection End Caps add a captivating custom detail that complements other matching accessories.

Fits '17-later Touring models equipped with 4.5" Screamin' Eagle Street Cannon Mufflers and Screamin' Eagle High-Flow Exhaust Systems with 4.5" Street Cannon Mufflers.

65100219	Chrome.	\$245.95
65100221	Machine Cut.	\$232.95
65100220	Satin Black.	\$245.95

F. BLUNT SLASH UP/DOWN/OUT MUFFLER END CAP KIT – 4.5"

These easy-to-install slash-cut end caps allow you to finish your 4.5" Screamin' Eagle Street Cannon mufflers your way. Sold in pairs. Installation hardware included.

Fits '17-later Touring models equipped with 4.5" Screamin' Eagle Street Cannon mufflers. Does not fit CVO™ Touring mufflers. Also fits High-Flow Exhaust Systems P/N's 64800059, 64800062, 65600329, 65600330, 65600331 and 65600332.

65100085	Chrome.	\$169.95
65100084A	Satin Black.	\$169.95

Street legal and/or street compliant statements refer to product meeting 50-State emissions and noise standards in the United States.

The street legal and/or street compliant statements may not apply to markets outside of the United States.

Notice: The prices appearing in this catalog are the manufacturer's suggested retail prices. Actual retail prices may vary.

352 SCREAMIN' EAGLE®

Milwaukee-Eight® Stage I Upgrade

A. SCREAMIN' EAGLE® HIGH-FLOW EXHAUST SYSTEM WITH STREET CANNON MUFFLERS

The Screamin' Eagle® High-Flow Exhaust system provides bolt-on performance by reducing the catalyst restrictions and improving exhaust flow. This exhaust system is optimized for use with Screamin' Eagle Stage Kit-equipped Milwaukee-Eight® engines. The complete exhaust system starts with race-shop constructed oversized mandrel-bent and hand TIG-welded stainless steel head pipes, and flows through a unique crossover to improve the flow of spent cylinder gasses. The large inlet 4.5" Street Cannon mufflers feature baffles that are optimized for aggressive performance and sound under acceleration, and deliver a rich mellow note. The combination of tuned-flow headers and Street Cannon mufflers with relocated catalyst maximizes horsepower, maintains solid midrange torque and manages heat. The proof is in the horsepower and torque numbers. Dial the system to your motorcycle by using the Screamin' Eagle Pro Street Tuner to tune your ECM specifically to match your performance upgrades. The complete system includes exhaust headers pre-tapped for standard or Screamin' Eagle wide-band O2 sensors, large 4.5" diameter Street Cannon mufflers, and matching exhaust heat shields. Complete the look with your choice of custom muffler end caps (sold separately). This High-Flow Exhaust System is designed to pair with a 128CI or 131CI Stage IV Kit or Crate Engine to ensure maximum performance. 49-State U.S. EPA compliant. Refer to www.H-D.com/Shop for status.

Fits '17-later Touring models. Does not fit Trike models. Does not fit with Dominion™ Transmission Side Covers. Separate purchase of Screamin' Eagle 4.5" endcaps required. All models require ECM calibration with Screamin' Eagle Pro Street Tuner for proper installation. See Dealer for details. Does not fit California models.

65600330	Gloss Black with Gloss Black Mufflers.	\$2,017.95
65600331	Chrome with Chrome Mufflers.	\$1,592.95
65600332	Satin Black with Satin Black Mufflers.	\$1,699.95



A. SCREAMIN' EAGLE HIGH-FLOW EXHAUST SYSTEM WITH STREET CANNON MUFFLERS GLOSS BLACK WITH GLOSS BLACK MUFFLERS



A. SCREAMIN' EAGLE HIGH-FLOW EXHAUST SYSTEM WITH STREET CANNON MUFFLERS CHROME WITH CHROME MUFFLERS



A. SCREAMIN' EAGLE HIGH-FLOW EXHAUST SYSTEM WITH STREET CANNON MUFFLERS SATIN BLACK WITH SATIN BLACK MUFFLERS

NOTE: There is no warranty on exhaust pipes and mufflers with regard to any discoloration. Blueing is caused by tuning characteristics, cam timing, carburetor jetting, over-heating, etc. and is not caused by defective manufacturing.

Street legal and/or street compliant statements refer to product meeting 50-State emissions and noise standards in the United States.

The street legal and/or street compliant statements may not apply to markets outside of the United States.

Notice: The prices appearing in this catalog are the manufacturer's suggested retail prices. Actual retail prices may vary.



B. SCREAMIN' EAGLE STREET CANNON PERFORMANCE SLIP-ON MUFFLERS (SHOWN WITH SLASH UP/DOWN/OUT END CAPS)



C. MUFFLER END CAPS – 4"

SCREAMIN' EAGLE® 353

Milwaukee-Eight® Stage I Upgrade

B. SCREAMIN' EAGLE® STREET CANNON PERFORMANCE SLIP-ON MUFFLERS

Cue the orchestra. We tuned these mufflers to provide an exhaust note with some extra deep bass. You get the rumble you want and enhance that famous Harley sound, while preserving the peace with your neighbors. The tuned baffles work with the large internal volume to strike the perfect balance required to deliver performance that you can feel in your gut. The large 4.0" diameter Street Cannons provide free flow of exhaust gases with just the right amount of back pressure for a smooth-running ride. The die-cast Screamin' Eagle® medallion adds a rich touch to your bike's profile and a large selection of end cap designs are available (sold separately) to provide the perfect finishing touch. 50-State U.S. EPA compliant.

Fits '09-'16 Touring and '09-later Trike models (except CVO™ models and '10 FLHX and FLTRX models). Installation requires separate purchase of 4" end caps and Muffler Clamps P/N 65296-95A (Qty 2). All models require ECM calibration for proper installation. '17-later Trike models require recalibration with Screamin' Eagle Pro Street Tuner (sold separately).

64900186B	Chrome.	\$452.95
64900187B	Jet Black.	\$504.95

C. MUFFLER END CAPS – 4"

These End Cap Kits allow you to personalize your Screamin' Eagle Street Performance Touring Mufflers. Available in your choice of styles, these easy-to-install caps are dressed with the same finish as the mufflers and exhaust shields for a consistent look front to back. Sold in pairs, the kit includes all required mounting hardware.

Fits '09-'16 Touring and '09-later Trike models equipped with Screamin' Eagle Street Cannon Touring 4" End Cap Mufflers. Does not fit 4" CVO Touring mufflers.

65100062	Short Slash.	\$104.95
65100016	Revolver.	\$116.95
65100019	Slash Up/Down/Out.	\$116.95
65100017	Fishtail.	\$168.95
80611-09	Blunt Revolver.	\$147.95

NOTE: There is no warranty on exhaust pipes and mufflers with regard to any discoloration. Blueing is caused by tuning characteristics, cam timing, carburetor jetting, over-heating, etc. and is not caused by defective manufacturing.

Street legal and/or street compliant statements refer to product meeting 50-State emissions and noise standards in the United States.

The street legal and/or street compliant statements may not apply to markets outside of the United States.

Notice: The prices appearing in this catalog are the manufacturer's suggested retail prices. Actual retail prices may vary.

354 SCREAMIN' EAGLE®

Milwaukee-Eight® Stage II Upgrade

STAGE II

THE BASICS

• Choose a **TORQUE CAM** or **POWER CAM** based on riding style

• A performance cam increases both the lift in the valve train (pushing the valve open farther) and the duration of the valve opening (how long the valve stays open)

When installed by an authorized Harley-Davidson® Dealer within 60 days of the vehicle purchase, compliant kits do not impact the vehicle's limited warranty.



A. SCREAMIN' EAGLE® MILWAUKEE-EIGHT® STAGE II – TORQUE KIT (CHROME COVERS SHOWN)



B. SCREAMIN' EAGLE MILWAUKEE-EIGHT STAGE II – POWER KIT (GLOSS BLACK COVERS SHOWN)

A. SCREAMIN' EAGLE® MILWAUKEE-EIGHT® STAGE II – TORQUE KIT

This kit was developed for the budget-minded rider who wants to experience crisp throttle response and acceleration he or she can feel at slower speeds. The 5% increase in torque can be felt immediately off the line and continues to build by up to a 14% increase @ 4500 RPM – the ideal power band for passing slow-moving vehicles.

SE8-447 Cam

- Delivers enhanced torque and horsepower in the low to mid RPM range
- Produces passing power without a downshift or high revs
- Minimally invasive, only requiring opening of the cam chest
- Retains Original Equipment Factory Warranty

Fits '18-later Softail® and '17-later Touring and Trike models. Not intended for use on '18-later CVO™ Touring and Trike models. Not intended for use on Touring and Softail Models equipped with an OE 117 Engine. Requires separate purchase of Cam Drive Retention Kit P/N 25566-06. Installation may require Cam Spacer Kit P/N 25928-06. For '17-'18 Touring models, installation of Oil Pump Cover P/N 62400206 is recommended (sold separately). All models require ECM calibration with Screamin' Eagle® Pro Street Tuner for proper installation. See Dealer for details. Does not fit '22 California models. Refer to H-D.com/shop for status.

92500047	Chrome Covers.	\$492.95
92500074	Gloss Black Covers.	\$524.95

Fits '18-'22 California Softail and '17-'22 California Touring and California Trike models. Not intended for use on 18-later CVO models or models equipped with an OE 117ci engine. Requires separate purchase of Cam Drive Retention Kit P/N 25566-06. Installation may require Cam Spacer Kit P/N 25928-06. For '17-'18 Touring models, installation of Oil Pump Cover P/N 62400206 is recommended (sold separately). All models require ECM calibration with Screamin' Eagle Pro Street Tuner for proper installation.

92500127	Chrome.	\$524.95
92500129	Gloss Black.	\$549.95

THE PERFORMANCE

TORQUE KIT

• The rider will feel up to a 15% increase in performance in the low to mid RPM range

• Experience crisp throttle response and acceleration that can be felt at slower speeds, perfect for passing slow moving vehicles without downshifting

POWER KIT

• The rider will feel up to a 25% increase in performance in the mid to upper RPM range

• Experience an adrenaline-pumping burst of speed while heading toward the red line



TORQUE



POWER

B. SCREAMIN' EAGLE MILWAUKEE-EIGHT STAGE II – POWER KIT

This kit was developed for the budget-minded rider who wants to experience that adrenaline-pumping burst of speed while heading toward the red line. The additional power starts to build @ 3000 RPM and continues to build by up to 24% at redline. Riding the bike aggressively will require downshifting to lower gears to keep the engine operating in the higher RPM range.

SE8-462 Cam

- Ideal for riders looking for excitement and willing to ride in the upper RPM range
- Produces greater acceleration in the mid and upper RPM range
- Minimally invasive, only requiring opening of the cam chest
- Retains Original Equipment Factory Warranty

Fits '18-later Softail® and '17-later Touring models. Does not fit Trike models. Requires separate purchase of Cam Drive Retention Kit P/N 25566-06. Installation may require Cam Spacer Kit P/N 25928-06. For '17-'18 Touring models, installation of Oil Pump Cover P/N 62400206 is recommended (sold separately). All models require ECM calibration with Screamin' Eagle® Pro Street Tuner for proper installation. See Dealer for details. Does not fit '22 California models. Refer to H-D.com/shop for status.

92500058	Chrome Covers.	\$492.95
92500075	Gloss Black Covers.	\$524.95

Fits '18-'22 California Softail and '17-'22 California Touring models. Does not fit California Trike models. Requires separate purchase of Cam Drive Retention Kit P/N 25566-06. Installation may require Cam Spacer Kit P/N 25928-06. For '17-'18 Touring models, installation of Oil Pump Cover P/N 62400206 is recommended (sold separately). All models require ECM calibration with Screamin' Eagle Pro Street Tuner for proper installation.

92500128	Chrome.	\$524.95
92500130	Gloss Black.	\$549.95

Street legal and/or street compliant statements refer to product meeting 50-State emissions and noise standards in the United States. The street legal and/or street compliant statements may not apply to markets outside of the United States.

Notice: The prices appearing in this catalog are the manufacturer's suggested retail prices. Actual retail prices may vary.

STAGE II

SCREAMIN' EAGLE® 355

Milwaukee-Eight® Cams

C. MILWAUKEE-EIGHT® PERFORMANCE CAMS

Screamin' Eagle® SE8-447 Cam – Torque

- Enhanced torque in the low to mid RPM band
- Ideal for a fully loaded bike
- Increased horsepower in the mid RPM range
- Responds well to roll-on throttle application
- Crisp throttle response and acceleration at lower speeds
- Can be used with stock valve springs

Fits '18-later Softail® and '17-later Touring and Trike models. Requires separate purchase of Cam Drive Retention Kit P/N 25566-06. Installation requires removal of rocker box covers and rocker arms or installation of adjustable push-rods. Installation may require Cam Spacer Kit P/N 25928-06. All models require ECM calibration with Screamin' Eagle® Pro Street Tuner for proper installation. Pending Regulatory approval for '21-later models. Refer to product information at www.H-D.com/shop for status.

25400199	\$239.95
-----------------	-----------------

Screamin' Eagle SE8-462 Cam – Power

- Improved power in mid and upper RPM band
- Ideal for a fully loaded bike
- Thrilling acceleration and crisp throttle response
- Ideal for rider who likes to downshift and twist the throttle
- Responds well to aggressive throttle application
- Can be used with stock valve springs

Fits '18-later Softail and '17-later Touring models. Requires separate purchase of Cam Drive Retention Kit P/N 25566-06. Installation may require Cam Spacer Kit P/N 25928-06. All models require ECM calibration with Screamin' Eagle Pro Street Tuner for proper installation. Pending Regulatory approval for '20-later models. Refer to product information at www.H-D.com/shop for status.

25400200	\$239.95
-----------------	-----------------

Screamin' Eagle SE8-498 Cam – Power

Replacement cam for models equipped with Screamin' Eagle Milwaukee-Eight® Stage III Kits.

- Improved acceleration on the straightaway
- Ideal for lighter bike with bigger displacement
- Exhilarating acceleration at high engine speeds.
- Responds well to a healthy twist of the throttle
- High-lift profile for complete filling of cylinders
- Requires Performance Valve Springs P/N 18100080

25400202	\$239.95
-----------------	-----------------

Screamin' Eagle SE8-515 Cam

Replacement cam for models equipped with Screamin' Eagle Milwaukee-Eight 114 or 117ci Stage IV kits.

- Hard acceleration off the line
- Improved mid-range and high RPM horsepower
- Stump-pulling torque throughout the RPM band
- Significant increase in rear wheel torque and power
- High lift and long duration for complete cylinder filling
- Requires Performance Valve Springs P/N 18100080

25400201	\$239.95
-----------------	-----------------

Screamin' Eagle SE8-517 Cam

Developed for Milwaukee-Eight 128CI and 131CI Stage IV kits, this high-performance cam enhances efficient filling of the cylinder at the optimum timing. Offered as a stand-alone component for the engine builder looking to develop a custom performance recipe, it provides premium mid- to upper-range power.

Replacement cam for models equipped with Screamin' Eagle Milwaukee-Eight 128 or 131CI Stage IV kits.

25400353	\$274.95
-----------------	-----------------

Description	Part Number	Lift @ Valve Intake/Exhaust	Duration @ .050" Intake/Exhaust	Timing @ .050" Lift Open/Closed	TDC Lift @ Valve Intake/Exhaust
Stock	25400190	.350"/.374"	174°/199°	Intake: 7° ATDC/1° ABDC Exhaust: 33° BBDC/14° BTDC	.057"/.048"
CVO™	25400273	.432"/.445"	188°/212°	Intake: 11° ATDC/19° ABDC Exhaust: 47° BBDC/15° BTDC	.044"/.044"
SE8-447 TORQUE	25400199	.447"/.462"	197°/217°	Intake: 0° ATDC/17° ABDC Exhaust: 42° BBDC/5° BTDC	.080"/.064"
SE8-462 POWER	25400200	.462"/.463"	197°/235°	Intake: 7° ATDC/24° ABDC Exhaust: 53° BBDC/2° BTDC	.057"/.086"
SE8-498 POWER Included in Stage III Kit	25400202	.498"/.491"	209°/247°	Intake: 4° ATDC/33° ABDC Exhaust: 60° BBDC/7° BTDC	.065"/.103"
SE8-515 POWER Included in Stage IV Kit	25400201	Front Cylinder .515"/.513"	Front Cylinder 227°/249°	Front Cylinder Intake: 2° BTDC/45° ABDC Exhaust: 62° BBDC/7° ATDC	Front Cylinder .056"/.066"
		Rear Cylinder .516"/.515"	Rear Cylinder 219°/242°	Rear Cylinder Intake: 6° ATDC/45° ABDC Exhaust: 61.5° BBDC/.5° ATDC	Rear Cylinder .036"/.052"
SE8-517 POWER Included in Stage IV Kit	25400353	Front Cylinder .515"/.513"	Front Cylinder 227°/242°	Front Cylinder Intake: 7° BTDC/40° ABDC Exhaust: 62° BBDC/7° ATDC	Front Cylinder .112"/.066"
		Rear Cylinder .515"/.513"	Rear Cylinder 227°/242°	Rear Cylinder Intake: 7° ATDC/40° ABDC Exhaust: 61° BBDC/.5° ATDC	Rear Cylinder .112"/.052"

Theoretical, based on rocker arm ratio of 1.65. Valve train components, operation temperature and tolerance stack-up will affect actual lifts.

C. SCREAMIN' EAGLE PERFORMANCE CAM SPECS

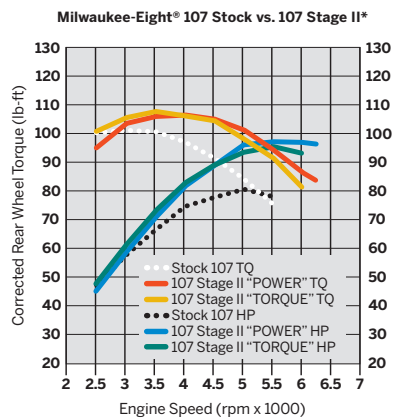

* FLHX 107 Stage II "POWER" with Ventilator A/C & Street Cannon Mufflers
* FLHX 107 Stage II "TORQUE" with Heavy Breather A/C & Street Cannon Mufflers

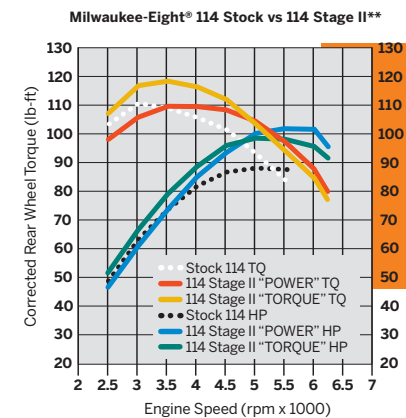

** FLHXSE 114 Stage II "POWER" with Ventilator A/C & Street Cannon Mufflers
** FLHXSE 114 Stage II "TORQUE" with Heavy Breather A/C & Street Cannon Mufflers

Street legal and/or street compliant statements refer to product meeting 50-State emissions and noise standards in the United States. The street legal and/or street compliant statements may not apply to markets outside of the United States.

Notice: The prices appearing in this catalog are the manufacturer's suggested retail prices. Actual retail prices may vary.

356 SCREAMIN' EAGLE®

Milwaukee-Eight® Stage II Upgrade

A. SCREAMIN' EAGLE® PREMIUM TAPERED QUICK-INSTALL ADJUSTABLE PUSHRODS

These premium pushrods are tapered for enhanced clearance at the cylinder head, allowing the use of higher-lift cams. The one-piece chrome moly tube adds rigidity and durability and the threaded adjustment feature provides easy cam installation without removing the cylinder heads or rocker boxes. To simplify adjustment, the tube features six flats, with one flat marked with a large dot for tracking the adjustment. The threaded rod features 4 flats to reduce wrench swing. Kit includes 4 pushrods and required pushrod tube covers.

Fits '18-later Softail® and '17-later Touring and Trike models.

17900073 With Black Covers. **\$329.95**

17900058 With Chrome Covers. **\$274.95**

B. SCREAMIN' EAGLE PERFORMANCE VALVE SPRING KIT

These performance beehive-shaped valve springs provide increased stiffness and strength in a compact design. Designed to support the installation of higher lift cams, these performance springs help maintain the stability of the valve train in high RPM conditions. Complete kit includes 8 springs, upper collars and keepers and lower collars with integral valve seals. Recommended for use with cam lifts greater than .470".

18100080 **\$323.95**

Fits '18-later Softail and '17-later Touring and Trike models.



A. SCREAMIN' EAGLE PREMIUM TAPERED QUICK-INSTALL ADJUSTABLE PUSHRODS – MILWAUKEE-EIGHT POWERTRAIN – BLACK COVERS



A. SCREAMIN' EAGLE PREMIUM TAPERED QUICK-INSTALL ADJUSTABLE PUSHRODS – MILWAUKEE-EIGHT POWERTRAIN – CHROME COVERS



B. SCREAMIN' EAGLE PERFORMANCE VALVE SPRING KIT – MILWAUKEE-EIGHT POWERTRAIN

Street legal and/or street compliant statements refer to product meeting 50-State emissions and noise standards in the United States.

The street legal and/or street compliant statements may not apply to markets outside of the United States.

Notice: The prices appearing in this catalog are the manufacturer's suggested retail prices. Actual retail prices may vary.



358 SCREAMIN' EAGLE®

Milwaukee-Eight® Stage III Upgrade

STAGE III

A. SCREAMIN' EAGLE® MILWAUKEE-EIGHT® ENGINE STAGE III KITS

This Stage III kit has been developed for the rider looking for a solid "seat of the pants" increase you can feel every time you roll on the throttle. The bump up in displacement and compression deliver a significant increase in torque and power over stock, all the while restoring the sensation of riding solo when you're loaded down. The Stage III 107CI to 119CI upgrade delivers up to 23% more horsepower and 17% more torque and the 114CI to 122CI upgrade increases power by up to 15% and 13% more torque when compared to the Original Equipment engine configurations. Plus there's a one-year manufacturer's warranty and eligibility for coverage under factory vehicle warranty when dealer-installed within 60 days of vehicle purchase.

- Delivers increased response throughout the entire RPM range.
- Provides thrilling acceleration when twisting the throttle.
- Maintains flat torque curve from cruising RPM to redline.
- Can be installed without removing the engine from chassis.

49-State U.S. EPA Compliant on select '18-later Softail® Models. Refer to www.H-D.com/Shop for status.

Performance components include:

- Screamin' Eagle® 4.155 Big Bore Bolt-On Cylinders
- Screamin' Eagle® Forged 11.0:1 High-Compression Pistons and Rings
- Screamin' Eagle SE8-447 Torque
- Screamin' Eagle High Capacity Tappets
- Screamin' Eagle High Performance Cam Bearing
- Screamin' Eagle Stage III Timer Cover & Insert
- Multi-layer coated Head Gaskets
- Cylinder Base and Cam Cover Gaskets
- Most necessary gaskets and seals
- Appropriate 119CI or 122CI Timer Cover Medallion and Timer Cover Base

SCREAMIN' EAGLE STAGE III - 107CI TO 119CI KIT

Fits '18-later Softail models equipped with 107CI Milwaukee-Eight engine. FXFB models require separate purchase of Screamin' Eagle Softail High-Flow Exhaust System P/N's 64900828 or 64900829. Requires separate purchase of Cam Drive Retention Kit P/N 25566-06. Installation may require Cam Spacer Kit P/N 25928-06. All models require ECM calibration with Screamin' Eagle Pro Street Tuner for proper installation.

92500083	Black Non-Highlighted.	\$1,966.95
92500096	Black Highlighted.	\$1,966.95

SCREAMIN' EAGLE STAGE III - 114CI OR 117CI TO 122CI KIT

Fits '18-later Softail models equipped with 114 or 117CI Milwaukee-Eight engines. Requires separate purchase of Cam Drive Retention Kit P/N 25566-06. Installation may require Cam Spacer Kit P/N 25928-06. FXFB and FXFBS models require separate purchase of Screamin' Eagle Softail High Flow Exhaust P/N's 64900828 or 64900829. FXDR114 models require separate purchase of Header Pipe Assembly P/N 65600300. All models require ECM calibration with Screamin' Eagle Pro Street Tuner for proper installation.

92500097	Black Highlighted.	\$1,966.95
----------	--------------------	-------------------



WA. SCREAMIN' EAGLE® MILWAUKEE-EIGHT® ENGINE STAGE III KITS
BLACK NON-HIGHLIGHTED



A. SCREAMIN' EAGLE® MILWAUKEE-EIGHT® ENGINE STAGE III KITS
BLACK HIGHLIGHTED

Street legal and/or street compliant statements refer to product meeting 50-State emissions and noise standards in the United States.

The street legal and/or street compliant statements may not apply to markets outside of the United States.

Notice: The prices appearing in this catalog are the manufacturer's suggested retail prices. Actual retail prices may vary.

STAGE III

SCREAMIN' EAGLE® 359

Milwaukee-Eight® Stage III Upgrade

B. SCREAMIN' EAGLE® MILWAUKEE-EIGHT® ENGINE STAGE III KITS

This Stage III kit has been developed for the rider looking for a solid "seat of the pants" increase you can feel every time you roll on the throttle. The bump up in displacement and compression deliver a significant increase in torque and power over stock, all the while restoring the sensation of riding solo when you're loaded down. The Stage III 107CI to 119CI upgrade delivers up to 23% more horsepower and 17% more torque and the 114CI to 122CI upgrade increases power by up to 15% and 13% more torque when compared to the Original Equipment engine configurations. Plus there's a one-year manufacturer's warranty and eligibility for coverage under factory vehicle warranty when dealer-installed within 60 days of vehicle purchase.

- Delivers increased response throughout the entire RPM range.
- Produces flexible roll-on passing power without a required downshift.
- Delivers excellent stop-light to freeway speed on-ramp acceleration.

49-State U.S. EPA Compliant on select '18-later Softail® and '17-later Touring models. Refer to www.H-D.com/Shop for status.

Performance components include:

- Screamin' Eagle® 4.155 Big Bore Bolt-On Cylinders
- Screamin' Eagle Forged 11.0:1 High-Compression Pistons and Rings
- Screamin' Eagle SE8-447 Torque Cam
- Screamin' Eagle High Capacity Tappets
- Screamin' Eagle High Performance Cam Bearing
- Screamin' Eagle Stage III Timer Cover & Insert
- Multi-layer coated Head Gaskets
- Cylinder Base and Cam Cover Gaskets
- Most necessary gaskets and seals
- Appropriate 119CI or 122CI Timer Cover Medallion and Timer Cover Base



B. SCREAMIN' EAGLE® MILWAUKEE-EIGHT® ENGINE STAGE III KITS

Milwaukee-Eight 107 Touring Stock vs. 107-to-119 Stage III Kit w/ Street Cannons & Ventilator A/C

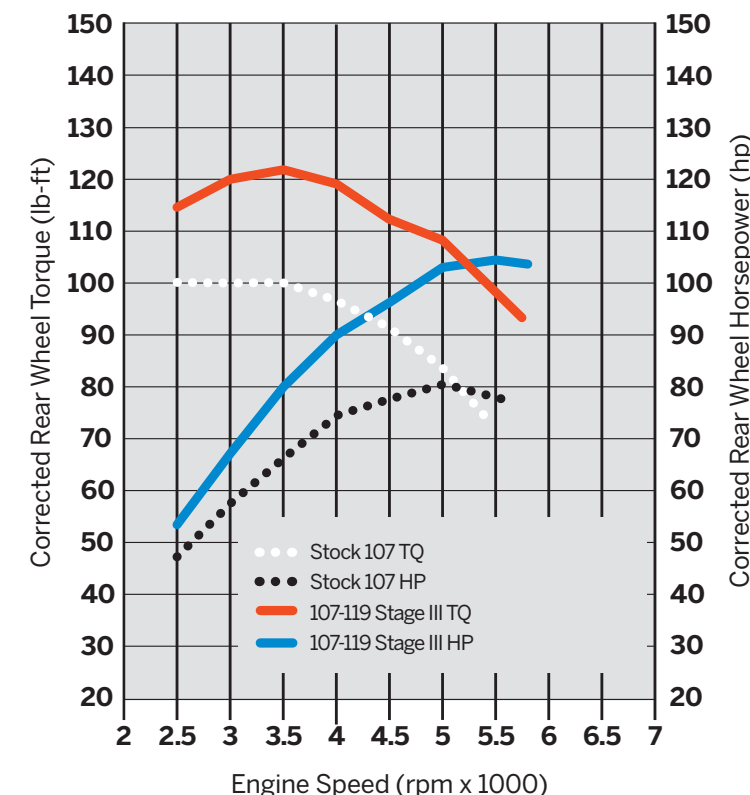

SCREAMIN' EAGLE STAGE III - 107CI TO 119CI KIT

Fits '17-later Touring models equipped with 107CI Milwaukee-Eight® engine. Does not fit Trike models. Requires separate purchase of Cam Drive Retention Kit P/N 25566-06. Installation may require Cam Spacer Kit P/N 25928-06. For '17-'18 Touring models, installation of Oil Pump Cover P/N 62400206 is recommended (sold separately). '17-'19 models require separate purchase of High-Capacity Oil Pump P/N 62400247. All models require ECM calibration with Screamin' Eagle Pro Street Tuner for proper installation.

92500084	Black Highlighted.	\$1,966.95
----------	--------------------	-------------------

SCREAMIN' EAGLE STAGE III - 114CI OR 117CI TO 122CI KIT

Fits '17-later Touring models equipped with 114 or 117CI Milwaukee-Eight engines. Does not fit Trike models. Requires separate purchase of Cam Drive Retention Kit P/N 25566-06. Installation may require Cam Spacer Kit P/N 25928-06. For '17-'18 Touring models, installation of Oil Pump Cover P/N 62400206 is recommended (sold separately). '17-'19 models require separate purchase of High-Capacity Oil Pump P/N 62400247 for Oil-Cooled models or 62400248 for Twin-Cooled models. All models require ECM calibration with Screamin' Eagle Pro Street Tuner for proper installation. Does not fit California models.

92500086	Black Highlighted.	\$1,966.95
----------	--------------------	-------------------

Street legal and/or street compliant statements refer to product meeting 50-State emissions and noise standards in the United States.

The street legal and/or street compliant statements may not apply to markets outside of the United States.

Notice: The prices appearing in this catalog are the manufacturer's suggested retail prices. Actual retail prices may vary.



STAGE IV

SCREAMIN' EAGLE® 361

Milwaukee-Eight® Stage IV Upgrade

B. SCREAMIN' EAGLE® MILWAUKEE-EIGHT® ENGINE STAGE IV KIT – 107CI TO 128CI

This Stage IV Kit was designed to deliver maximum horsepower – all the way to the redline. Features new CNC-ported heads with 1mm bigger valves and fully machined combustion chambers. Coupled with the kit's high-lift SE8-517 cam, high compression pistons and a 64mm throttle body and intake manifold, this combination delivers a thrilling 126 ft-lb of torque and 121 HP rear-wheel output when paired with Screamin' Eagle® Street Cannon Mufflers. It's designed to run wide open at high-end RPMs and provide a significant boost of torque from cruising speed. You'll feel the difference as soon as you twist the throttle. When installed by an authorized Harley-Davidson® Dealer within 60 days of the vehicle purchase, compliant kits do not impact the vehicle's limited warranty.

- Delivers increased response throughout the entire RPM range
- Provides thrilling acceleration when twisting the throttle
- Maintains flat torque curve from cruising RPM to redline
- Can be installed without removing the engine from chassis

49-State U.S. EPA Compliant on select '17-later Touring Models.

Performance components include:

- Screamin' Eagle CNC Ported Cylinder Head with CNC machined chamber and 1mm larger valves
- 128 Stage IV Timer cover
- SE8-517 High-Lift Cam
- Forged High Compression Pistons
- Screamin' Eagle High Performance Cam Bearing
- Screamin' Eagle High Performance Tappets
- Screamin' Eagle 4.31" Steel Sleeve Cylinders
- Screamin' Eagle 64mm Throttle Body and Cast Manifold
- Screamin' Eagle High Flow Injectors (5.5 g/sec)

Fits '17-'18 Touring models equipped with air/Oil-Cooled Milwaukee-Eight 107CI engine. Does not fit Trike models. '17-'19 models require separate purchase of High-Capacity Oil Pump P/N 62400248. '17-'18 Screamin' Eagle High-Capacity Clutch Plate Kit P/N 37000258. All models require ECM recalibration with the Pro Street Tuner for proper installation.

92500077	Twin-Cooled™ Black Highlighted.	\$3,818.95
92500078	Oil-Cooled Black Highlighted.	\$3,818.95



B. SCREAMIN' EAGLE® MILWAUKEE-EIGHT® ENGINE STAGE IV KIT TWIN-COOLED -BLACK HIGHLIGHTED



B. SCREAMIN' EAGLE® MILWAUKEE-EIGHT® ENGINE STAGE IV KIT OIL-COOLED -BLACK HIGHLIGHTED

Street legal and/or street compliant statements refer to product meeting 50-State emissions and noise standards in the United States.

The street legal and/or street compliant statements may not apply to markets outside of the United States.

Notice: The prices appearing in this catalog are the manufacturer's suggested retail prices. Actual retail prices may vary.

362 SCREAMIN' EAGLE®

Milwaukee-Eight® Stage IV Upgrade

STAGE IV

A. SCREAMIN' EAGLE® MILWAUKEE-EIGHT® ENGINE STAGE IV KIT 114CI OR 117CI TO 131CI

Go big or go home. With the largest displacement of any Harley-Davidson® Stage Kit, this 114CI to 131CI Stage IV Kit was designed to deliver maximum horsepower – all the way to the redline. Packaged with patent-protected cylinder technology, it allows for the largest bolt-on engine upgrade to any Milwaukee-Eight® motor. Features new CNC-ported heads with 1mm bigger valves and fully machined combustion chambers. Coupled with the kit's high-lift SE8-517 cam, high compression pistons and a 64mm throttle body and intake manifold, this combination delivers a thrilling 131 ft-lb of torque and 121 HP rear-wheel output when paired with Screamin' Eagle® Street Cannon Mufflers. It's designed to run wide open at high-end RPMs and provide a significant boost of torque from cruising speed. You'll feel the difference as soon as you twist the throttle. When installed by an authorized Harley-Davidson Dealer® within 60 days of the vehicle purchase, compliant kits do not impact the vehicle's limited warranty.

- Delivers increased response throughout the entire RPM range.
- Provides thrilling acceleration when twisting the throttle.
- Maintains flat torque curve from cruising RPM to redline.
- Can be installed without removing the engine from chassis.

49-State U.S. EPA Compliant on select '18-later Touring Models. Refer to www.H-D.com/Shop for status.

Performance components include:

- Screamin' Eagle CNC Ported Cylinder Head with CNC machined chamber and 1mm larger valves
- 131 Stage IV Timer cover
- SE8-517 High-Lift Cam
- Forged High Compression Pistons
- Screamin' Eagle High Performance Cam Bearing
- Screamin' Eagle High Performance Tappets
- Screamin' Eagle 4.31" Steel Sleeve Cylinders
- Screamin' Eagle 64mm Throttle Body and Cast Manifold
- Screamin' Eagle High Flow Injectors (5.5 g/sec)



A. SCREAMIN' EAGLE® MILWAUKEE-EIGHT® ENGINE STAGE IV KIT – OIL-COOLED – BLACK HIGHLIGHTED



A. SCREAMIN' EAGLE® MILWAUKEE-EIGHT® ENGINE STAGE IV KIT – OIL-COOLED – BLACK GRANITE

Street legal and/or street compliant statements refer to product meeting 50-State emissions and noise standards in the United States.

The street legal and/or street compliant statements may not apply to markets outside of the United States.

Notice: The prices appearing in this catalog are the manufacturer's suggested retail prices. Actual retail prices may vary.

STAGE IV

362 SCREAMIN' EAGLE®

Milwaukee-Eight® Stage IV Upgrade

A. SCREAMIN' EAGLE® MILWAUKEE-EIGHT® ENGINE STAGE IV KIT

Oil-Cooled:

Fits '17-later Touring models equipped with air/Oil-Cooled Milwaukee-Eight® 114 or 117CI engine. Does not fit Trike models. '17-'19 models require separate purchase of High-Capacity Oil Pump P/N 62400248. '17-'18 Screamin' Eagle® High-Capacity Clutch Plate Kit P/N 37000258. All models require ECM recalibration with the Pro Street Tuner for proper installation. Does not fit California models.

92500079	Black Highlighted.	\$3,818.95
92500082	Black Granite.	\$3,818.95

A. SCREAMIN' EAGLE® MILWAUKEE-EIGHT® ENGINE STAGE IV KIT

Twin-Cooled:

Fits '17-later Touring models equipped with Twin-Cooled Milwaukee-Eight 114 or 117CI engine. Does not fit Trike models. '17-'19 models require separate purchase of High-Capacity Oil Pump P/N 62400248. '17-'18 Screamin' Eagle High-Capacity Clutch Plate Kit P/N 37000258. All models require ECM recalibration with the Pro Street Tuner for proper installation. Does not fit California models.

92500080	Black Highlighted.	\$3,818.95
92500081	Black Granite.	\$3,818.95



A. SCREAMIN' EAGLE® MILWAUKEE-EIGHT® ENGINE STAGE IV KIT – TWIN-COOLED – BLACK GRANITE



A. SCREAMIN' EAGLE® MILWAUKEE-EIGHT® ENGINE STAGE IV KIT – TWIN-COOLED – BLACK HIGHLIGHTED

Milwaukee-Eight Twin-Cooled 117 Stock vs. 131 Stage IV with Street Cannon Mufflers

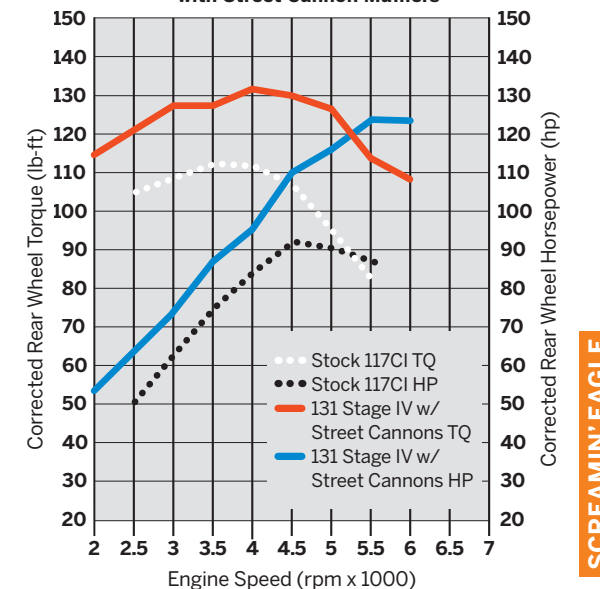

Street legal and/or street compliant statements refer to products meeting EPA (49-State) and/or California (50-State) emissions and noise standards in the United States as specified.

The street legal and/or street compliant statements may not apply to markets outside of the United States.

Notice: The prices appearing in this catalog are the manufacturer's suggested retail prices. Actual retail prices may vary.

SCREAMIN' EAGLE

364 SCREAMIN' EAGLE®

Milwaukee-Eight® Stage IV Upgrade

STAGE IV

SCREAMIN' EAGLE® MILWAUKEE-EIGHT® ENGINE STAGE IV KITS

Go big or go home. With the largest displacement of any Harley-Davidson® Stage Kit, this 107CI to 128CI or 114CI to 131CI Stage IV Kit is designed to deliver maximum horsepower – all the way to the redline. Packaged with patent-protected cylinder technology, it allows for the largest bolt-on engine upgrade to any Milwaukee-Eight® motor. Features new CNC-ported heads with 1mm bigger valves and fully machined combustion chambers. Coupled with the kit's high-lift SE8-517 cam, high compression pistons and a 64mm throttle body and intake manifold, this combination delivers a thrilling 135 ft-lb of torque and 124 HP rear-wheel output when paired with the Screamin' Eagle Street Cannon Mufflers and Ventilator Air Cleaner. It's designed to run wide open at high-end RPMs and provide a significant boost of torque from cruising speed. You'll feel the difference as soon as you twist the throttle. When installed by an authorized Harley-Davidson® Dealer within 60 days of the vehicle purchase, compliant kits do not impact the vehicle's limited warranty.

- Delivers increased response throughout the entire RPM range.
- Provides thrilling acceleration when twisting the throttle.
- Maintains flat torque curve from cruising RPM to redline.
- Can be installed without removing the engine from chassis.

49-State U.S. EPA Compliant on select '18-later Softail® Models. Refer to www.H-D.com/Shop for status.

Performance components include:

- Screamin' Eagle CNC PCNC-ported cylinder head with CNC-machined chamber and 1mm larger valves
- 128 or 131 Stage IV Timer cover
- SE8-517 High-Lift Cam
- Screamin' Eagle Forged 10.7:1 High-Compression Pistons and Rings
- Screamin' Eagle High Performance Cam Bearing
- Screamin' Eagle High Performance Tappets
- Screamin' Eagle 4.31" Steel Sleeve Cylinders
- Screamin' Eagle 64mm Throttle Body and Cast Manifold
- Screamin' Eagle High Flow Injectors (5.5 g/sec)

A. SCREAMIN' EAGLE® STAGE IV - 107CI TO 128CI KIT

Fits '18-later Softail 107CI models. FXFB requires separate purchase of Screamin' Eagle® Softail High Flow Exhaust P/N's 64900828 or 64900829. Requires separate purchase of Cam Drive Retention Kit P/N 25566-06. Installation may require Cam Spacer Kit P/N 25928-06. '18-'19 models require separate purchase of High-Capacity Oil Pump P/N 62400247. All models require ECM calibration with Screamin' Eagle Pro Street Tuner for proper installation. Does not fit California models.

92500094 107CI to 128CI Black Highlighted. **\$3,658.95**



A. SCREAMIN' EAGLE® STAGE IV - 107CI TO 128CI KIT
BLACK HIGHLIGHTED

Milwaukee-Eight 128 Stage IV Softail vs 107 Softail Stock

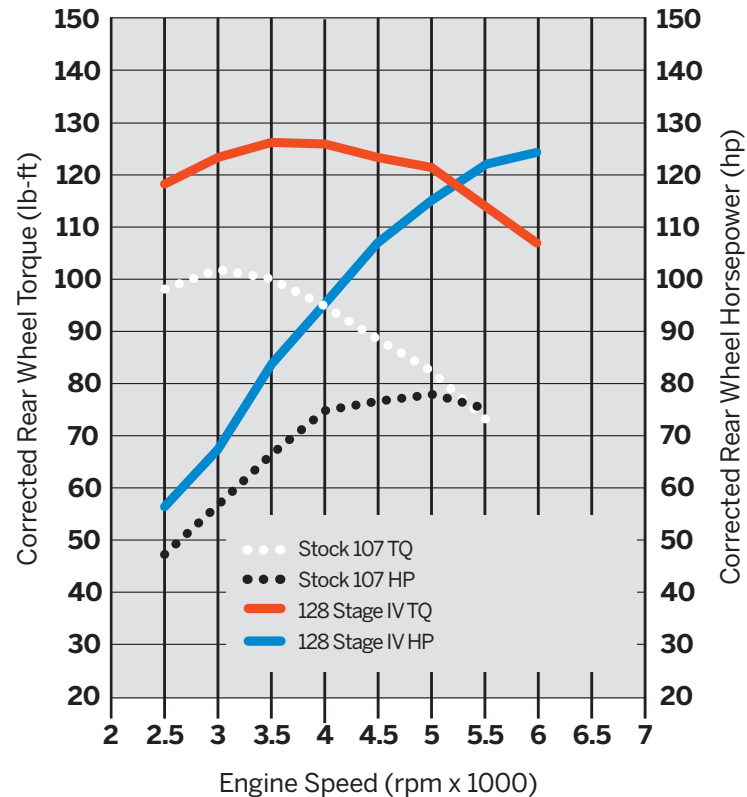

Street legal and/or street compliant statements refer to products meeting EPA (49-State) and/or California (50-State) emissions and noise standards in the United States as specified.

The street legal and/or street compliant statements may not apply to markets outside of the United States.

Notice: The prices appearing in this catalog are the manufacturer's suggested retail prices. Actual retail prices may vary.

STAGE IV

SCREAMIN' EAGLE® 365

Milwaukee-Eight® Stage IV Upgrade

B. SCREAMIN' EAGLE® STAGE IV - 114CI OR 117CI TO 131CI KIT

Fits '18-later Softail® 114CI or 117CI models. FXFBS requires separate purchase of Screamin' Eagle® Softail High Flow Exhaust P/N's 64900828 or 64900829. Requires separate purchase of Cam Drive Retention Kit P/N 25566-06. Installation may require Cam Spacer Kit P/N 25928-06. '18-'19 models require separate purchase of High-Capacity Oil Pump P/N 62400247. FXDR114 models require the separate purchase of 65600300. All models require ECM calibration with Screamin' Eagle Pro Street Tuner for proper installation. Does not fit California models.

92500095 114CI to 131CI Black Highlighted. **\$3,658.95**



B. SCREAMIN' EAGLE® STAGE IV - 114CI TO 131CI KIT
BLACK HIGHLIGHTED

Milwaukee-Eight 131 Stage IV Softail vs 114 Softail Stock

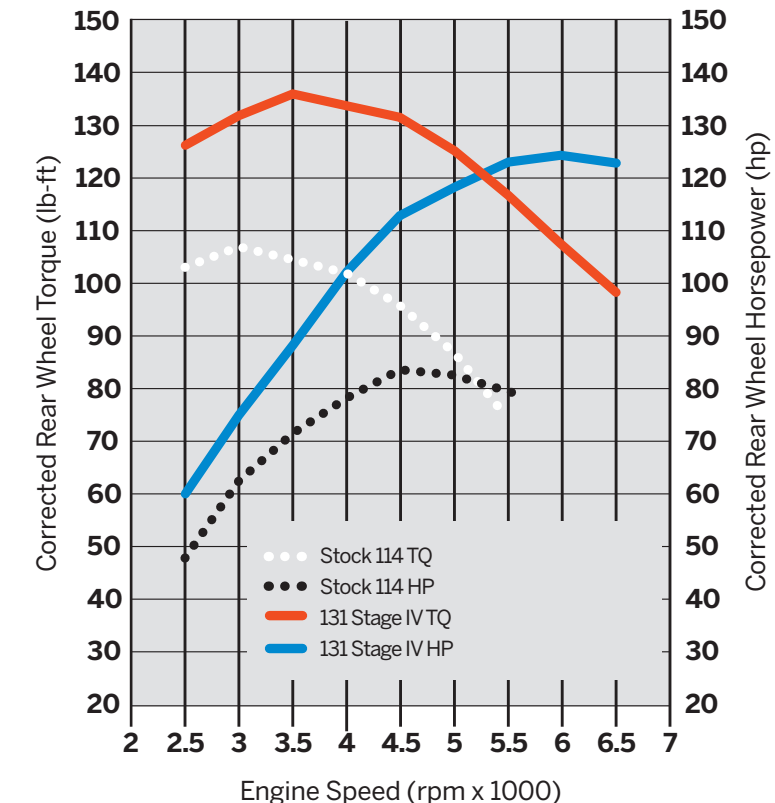

Street legal and/or street compliant statements refer to products meeting EPA (49-State) and/or California (50-State) emissions and noise standards in the United States as specified.

The street legal and/or street compliant statements may not apply to markets outside of the United States.

Notice: The prices appearing in this catalog are the manufacturer's suggested retail prices. Actual retail prices may vary.

366 SCREAMIN' EAGLE®

High Volume Oil Pump & Cam Support

SCREAMIN' EAGLE® HIGH VOLUME OIL PUMP & CAM SUPPORT PLATE KIT

A high-performance Milwaukee-Eight® engine deserves high-performance oiling. This new kit includes a Super Sucker oil pump to improve the oil flow rate to critical engine components, and a CNC machined billet aluminum cam plate for precise alignment of a high-performance cam and chain. It's the ideal component combination for a tuned-up Milwaukee-Eight engine.

Install and ride hard with confidence.

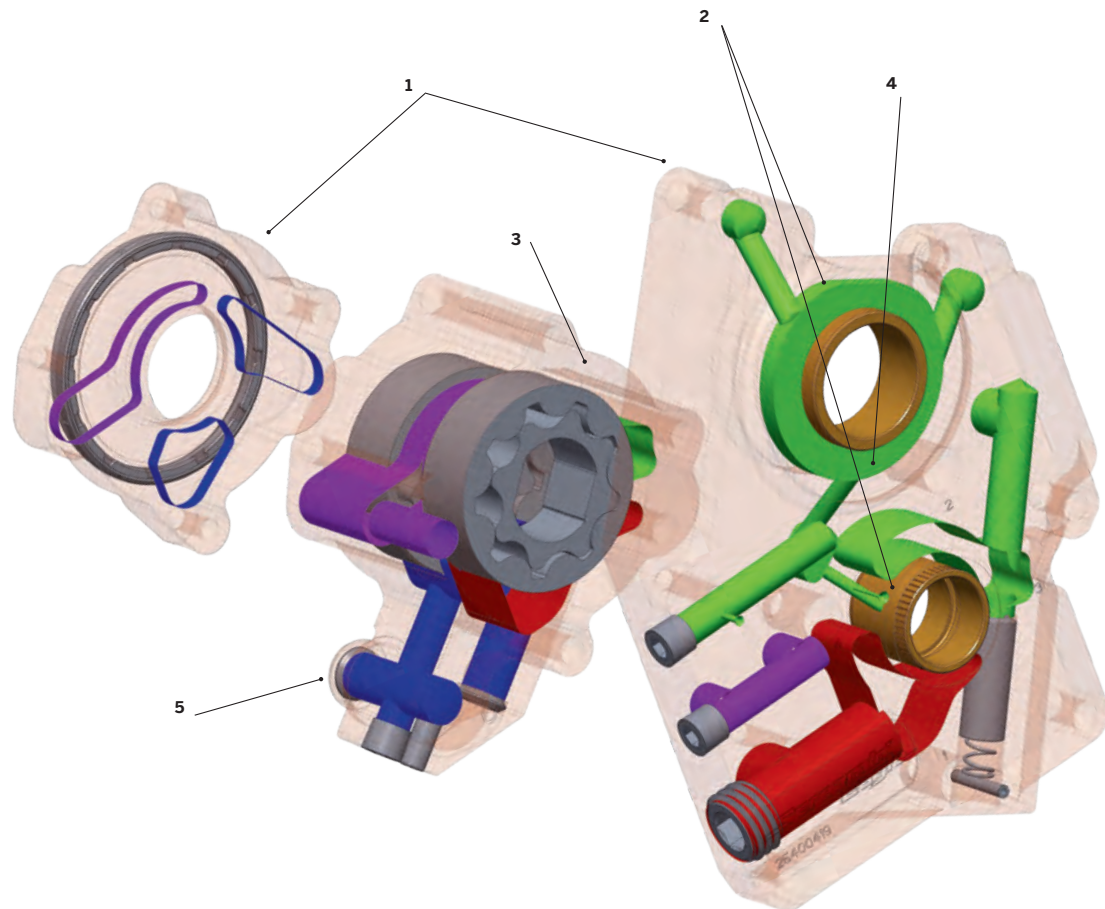

1 6061 BILLET CAM PLATE

The cam support plate and oil pump are made from heat-treated 6061 billet aluminum with a surface-hardened orange anodized finish. CNC machining ensures precise dimensions and constant material thickness across the plate and pump, enabling perfect alignment of components.

2 660 HI-PRO BUSHINGS

Pressed-in 660 bronze cam and pinion shaft bushings provide enhanced wear resistance under increased loads from high-performance cams for miles of worry-free riding.

3 9% LARGER GEROTOR

The Super Sucker oil pump features a 9% larger gerotor for increased flow at idle and 33% more scavenge capacity compared to a 2020-Later Original Equipment oil pump, for increased performance, efficiency and engine durability.

4 HI-FLOW OIL PASSAGES

The hub-and-spoke oil passage design improves oil flow rate to critical engine components by minimizing restrictions from intersecting passages.

5 ENHANCED FILTERING

Two screens mounted in both pickups and a magnet in between the pickups provide extra oil filtering to remove potential contaminants before they can reach critical upper end components. This is key to promoting long life in high-performance engines.

SCREAMIN' EAGLE® 367

High Volume Oil Pump & Cam Support

A. SCREAMIN' EAGLE® PRO HIGH VOLUME OIL PUMP & CAM SUPPORT PLATE KIT

A high-performance Milwaukee-Eight® engine deserves high-performance oiling. This new kit(s) includes a Super Sucker oil pump to improve the oil flow rate to critical engine components, and a CNC machined billet aluminum cam plate for precise alignment of high-performance cam and chain. It's the ideal component combination for a tuned-up Milwaukee-Eight engine. Install and ride hard with confidence.

- Heat-treated 6061 billet aluminum cam support plate with an orange anodized finish is strong and rigid to provide superior strength, rigidity, and durability
- CNC-precision machining ensures precise dimensions and constant material thickness across the plate, enabling perfect alignment of cams and chains
- Pressed-in 660 bronze cam bushings provide enhanced wear resistance under increased loads from high-performance cams for miles of worry-free riding
- Oil pump features a 9% larger gerotor for increased flow at idle and 33% more scavenge capacity compared to a 2020-Later Original Equipment oil pump, for increased performance, efficiency and engine durability
- The hub-and-spoke oil passage design improves oil flow rate to critical engine components
- Upgraded filter protection promotes engine durability: Two screens mounted in both pickups and a magnet in between the pickups provide extra oil filtering to remove contaminants before they can reach critical upper end component

62400260 **\$756.95**
Fits '17-later models equipped with an Air/Oil-Cooled Milwaukee-Eight® engine.

62400264 **\$756.95**
Fits '17-later models equipped with a Twin-Cooled™ Milwaukee-Eight® engine.



A. SCREAMIN' EAGLE® PRO HIGH VOLUME OIL PUMP & CAM SUPPORT PLATE KIT

B. SCREAMIN' EAGLE MILWAUKEE-EIGHT® – HEADBOLT KIT

Details matter when building a high-performance engine. Details like these Screamin' Eagle® Milwaukee-Eight Head Bolts – made from 8740 chromoly to be 23 percent stronger than stock bolts. The ideal upgrade for big-displacement and high-compression racing applications or Stage III or Stage IV builds. Lock down your top end, for the long run.

- Black oxide finish with Screamin' Eagle logo provides corrosion resistance and showcases performance.
- Premium 8740 chromoly steel bolts provide a 23% increase in ultimate strength and 23% increase in yield strength compared to Original Equipment head bolts for desirable clamp load on a higher-compression engine.
- Cost savings – these bolts may be reused if the top end is disassembled for upgrades or service
- Perfect upgrade during a Screamin' Eagle® Stage III or Stage IV installation.

10400069 **\$276.95**
Fits '17-later Milwaukee-Eight engines.



B. SCREAMIN' EAGLE® MILWAUKEE-EIGHT® – HEADBOLT KIT

Street legal and/or street compliant statements refer to products meeting EPA (49-State) and/or California (50-State) emissions and noise standards in the United States as specified.

The street legal and/or street compliant statements may not apply to markets outside of the United States.

Notice: The prices appearing in this catalog are the manufacturer's suggested retail prices. Actual retail prices may vary.

368 SCREAMIN' EAGLE®

Milwaukee-Eight® Engine Trim

A. SCREAMIN' EAGLE® TIMER COVER INSERTS - STAGE KIT LOGO

Showcase your bike's performance enhancements with the Screamin' Eagle® Stage Inserts. The Stage Inserts are made to complement the Screamin' Eagle Timer Cover Base (sold separately).

Fits '18-Later Softail® and '17-later Touring and Trike models equipped with Screamin' Eagle Timer Cover Base P/N 25600117.

1. 25600118	107 Stage I.	\$18.95
2. 25600119	107 Stage II.	\$18.95
3. 25600132	114 Stage I.	\$18.95
4. 25600120	114 Stage II.	\$18.95
5. 25600121	114 Stage III.	\$18.95
6. 25600122	114 Stage IV.	\$18.95
7. 25600123	117 Stage II.	\$18.95
8. 25600124	117 Stage III.	\$18.95
9. 25600125	117 Stage IV.	\$18.95
10. 25600153	119 Stage III.	\$18.95
11. 25600154	122 Stage III.	\$18.95
12. 25600127	128 Stage IV.	\$18.95
13. 25600129	131 Stage IV.	\$18.95

Shown with:

14. SCREAMIN' EAGLE TIMER COVER BASE

Showcase your bike's performance enhancements with the Screamin' Eagle Timer Cover Base. Start with this black Timer Cover and then select a Screamin' Eagle Stage Upgrade Insert that matches your engine size and Stage upgrades. (Inserts sold separately.)

25600117 **\$34.95**
Fits '18-later Softail and '17-later Touring and Trike models. Requires separate purchase of Screamin' Eagle Stage Insert.



A. SCREAMIN' EAGLE STAGE INSERTS – 107 STAGE I (SHOWN ON SCREAMIN' EAGLE TIMER COVER BASE)



A. SCREAMIN' EAGLE STAGE INSERTS & TIMER COVER BASE

Street legal and/or street compliant statements refer to product meeting 50-State emissions and noise standards in the United States.

The street legal and/or street compliant statements may not apply to markets outside of the United States.

Notice: The prices appearing in this catalog are the manufacturer's suggested retail prices. Actual retail prices may vary.



B. SCREAMIN' EAGLE® DERBY COVERS - GLOSS BLACK



C. SCREAMIN' EAGLE® DERBY COVERS - CHROME

SCREAMIN' EAGLE® 369

Milwaukee-Eight® Engine Trim

B. SCREAMIN' EAGLE® DERBY COVERS - GLOSS BLACK

Advertise the goods. This bold new Screamin' Eagle® derby cover tells the world you've taken a Harley-Davidson® Milwaukee-Eight® engine beyond stock. Beautifully finished in chrome or gloss black, designed to fit many Touring, Trike and Softail® models.

- High contrast paint fill pops against derby cover finish while red Bar & Shield provides a premium performance look
- Gloss Black finish matches other dark finishes

25701403 **\$75.95**

Fits '16-later Touring and Trike and '15-later FLHTCUL and FLHTKL models. Also fits '07-later Touring and Trike models equipped with Narrow-Profile Outer Primary Cover P/N 25700385 or 25700438.

25701407 **\$75.95**

Fits '18-later FLSB and '19-later Softail models. Also fits '18 Softail models equipped with Narrow Profile Primary Cover P/Ns 25701077, 25700913, 25700937, 25700941, 25701039, 25701040 and 25701043.

C. SCREAMIN' EAGLE® DERBY COVERS - CHROME

Advertise the goods. This bold new Screamin' Eagle® derby cover tells the world you've taken a Harley-Davidson® Milwaukee-Eight engine beyond stock. Beautifully finished in chrome or gloss black, designed to fit many Touring, Trike and Softail models.

- Black paint fill pops against derby cover finish while Red Bar & Shield provides a premium performance look
- Chrome finish matches other bright finishes

25701404 **\$75.95**

Fits '16-later Touring and Trike and '15-later FLHTCUL and FLHTKL models. Also fits '07-later Touring and Trike models equipped with Narrow-Profile Outer Primary Cover P/N 25700385 or 25700438.

25701408 **\$75.95**

Fits '18-later FLSB and '19-later Softail models. Also fits '18 Softail models equipped with Narrow Profile Primary Cover P/Ns 25701077, 25700913, 25700937, 25700941, 25701039, 25701040 and 25701043

Street legal and/or street compliant statements refer to products meeting EPA (49-State) and/or California (50-State) emissions and noise standards in the United States as specified.

The street legal and/or street compliant statements may not apply to markets outside of the United States.

Notice: The prices appearing in this catalog are the manufacturer's suggested retail prices. Actual retail prices may vary.

TWIN CAM POWERTRAIN

Screamin' Eagle® Stage upgrades offer complete street-compliant performance configurations engineered to generate specific torque and horsepower gains. Eliminating all the guesswork and trial-and-error testing normally associated with engine modifications, Stage upgrades include everything you need to enhance your bike's performance.



STAGE I

INTAKE + EXHAUST + TUNING

The easiest and most cost-effective step to improve your motorcycle's performance is to increase the airflow into and out of the engine. A high-flow air cleaner and system-matched slip-on mufflers provide horsepower and torque improvements you can feel throughout the RPM range, and serve as the core components for all performance upgrades. ECM calibration is required to tune the fuel flow and timing required to accommodate the improved airflow.

Stage I upgrade can be installed without engine disassembly. No special tools are required. Requires ECM tuning.

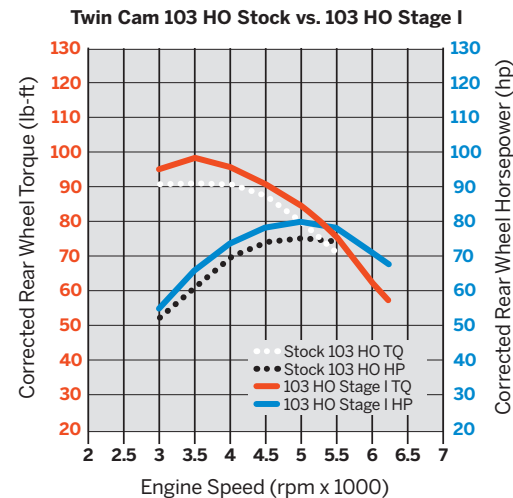

STAGE II

STAGE I + CAM UPGRADE

Adding performance cams to a Stage I equipped bike is the next step to improved performance. Cam choices allow you to tailor the engine's performance to your specific needs. A torque cam offers on-demand throttle response from low to mid RPM at cruising speed. A power cam targets high-RPM, wide-open throttle response that keeps pulling right up to redline. ECM calibration tuning is required to accommodate the increased valve timing, and performance valve springs may be required for high-lift cams.

Stage II upgrade requires minor engine disassembly to replace the cam. Adjustable pushrods allow cam installation without removing the rocker box. Special tools and ECM tuning are required.



STAGE III

STAGE I + CAMS, BIG BORE CYLINDERS & PISTONS

The next step on the performance journey is to build a bigger engine. An increase in engine displacement allows the engine to swallow more air and fuel, a higher-compression piston squeezes the air/fuel into a more volatile mixture, and when combined, generates more power when ignited. A displacement and compression increase provides torque increases throughout the entire RPM range with a 15-25% improvement in the mid-range power. ECM calibration tuning is required to adjust fuel flow and timing to accommodate the increased displacement.

Stage III bolt-on upgrade requires removal of the engine's top end and opening the cam chest. Engine remains in the chassis and no machining is required. Special tools and ECM tuning are required.



STAGE IV

STAGE I + CAMS, BIG BORE CYLINDERS, PISTONS, CYLINDER HEADS & THROTTLE BODY

To maximize the impact of the increased displacement gained with Stage III updates, the addition of free-flowing ported cylinder heads and a big bore throttle body top off the performance build. Designed to satisfy the high-RPM, throttle-twisting rider, the Stage IV update delivers 20-30% increase in power that keeps pulling right up to the redline, without sacrificing mid-range torque. ECM calibration tuning is required to add more fuel, and a higher-lift cam may be required to deliver maximum power.

Stage IV bolt-on upgrade requires removal of the engine's top end and opening the cam chest. Engine remains in the chassis and no machining is required. Special tools and ECM tuning are required.



Street legal and/or street compliant statements refer to product meeting 50-State emissions and noise standards in the United States.

The street legal and/or street compliant statements may not apply to markets outside of the United States.

372 SCREAMIN' EAGLE®

Twin Cam Stage I Upgrade

A. SCREAMIN' EAGLE® HEAVY BREATHER ELITE PERFORMANCE AIR CLEANER KIT

Really open it up. This Heavy Breather Elite Air Cleaner features a forward-facing filter element that flows huge volumes of clean air. The low-profile cast elbow and the oval cross-section element combine to hug the engine to provide increased leg room. The intake tube mounts to a custom back plate that features integral breathers and covers the throttle body and electronics for a finished look. Available in your choice of chrome or gloss black finish, the Heavy Breather Elite kit features a washable and re-chargeable filter and features bright chrome end caps and trim with Screamin' Eagle script. Kit includes filter, intake tube, custom back plate, water-repellent rain sock and all mounting hardware. 50-State U.S. EPA compliant.

Fits '16-'17 FXDLS and Softail®, '11-'17 CVO™ Softail and '14-'16 Touring and Freewheeler® models. Does not fit models equipped with Twin-Cooled™ engine, fairing lower glove boxes or fairing lower speakers. Also fits '16-'17 FXDLS and Softail, '14-'17 CVO Softail and '14-'16 Touring models equipped with Screamin' Eagle® 58mm Throttle Body. All models require ECM calibration for proper installation. '17-later models require recalibration with Screamin' Eagle Pro Street Tuner (sold separately).

29400173	Chrome.	\$403.95
29400285	Full Gloss Black.	\$403.95

NOTE: The washable and rechargeable filter uses a special coating to help filter fine particles from the incoming air. With time, the oil in the filter will dissipate and the element will begin to turn gray. The original red color can be restored with an application of K&N® Air Filter Oil.



A. SCREAMIN' EAGLE HEAVY BREATHER ELITE PERFORMANCE AIR CLEANER KIT – CHROME



A. SCREAMIN' EAGLE HEAVY BREATHER ELITE PERFORMANCE AIR CLEANER KIT – FULL GLOSS BLACK



A. SCREAMIN' EAGLE HEAVY BREATHER ELITE PERFORMANCE AIR CLEANER KIT



Street legal and/or street compliant statements refer to product meeting 50-State emissions and noise standards in the United States.

The street legal and/or street compliant statements may not apply to markets outside of the United States.

Notice: The prices appearing in this catalog are the manufacturer's suggested retail prices. Actual retail prices may vary.

SCREAMIN' EAGLE® 373

Twin Cam Stage I Upgrade

B. SCREAMIN' EAGLE® HEAVY BREATHER PERFORMANCE AIR CLEANER KIT

This high-flow forward-facing exposed element Air Cleaner Kit is sure to turn heads at the starting line. Featuring a polished elbow and exposed filter, this unique air cleaner system offers improved performance and airflow when compared to the stock or Screamin' Eagle® High-Flow Air Cleaner. The washable and rechargeable filter features a bright chrome end cap with a laser-engraved Screamin' Eagle logo. Intake tube and back plate are made from die-cast lightweight aluminum and are polished and chrome-plated or painted black for a brilliant finish. The back plate features integral breathers and sealed breather bolt plug. Kit includes a water-repellent rain sock and all mounting hardware. 50-State U.S. EPA compliant.

Fits '16-'17 Softail®, '11-'17 CVO™ Softail, '08-'16 Touring and '15-'16 Freewheeler® models. Also fits '16-'17 FXDLS and Softail, '14-'17 CVO Softail and '14-'16 Touring models equipped with Screamin' Eagle 58mm Throttle Body. Does not fit models equipped with fairing lower glove boxes or fairing lower speakers. Does not fit Twin-Cooled™ models. All models require ECM calibration for proper installation. '17 models require recalibration with Screamin' Eagle Pro Street Tuner (sold separately).

29006-09C	Gloss Black.	\$351.95
------------------	--------------	-----------------

Fits '08-'17 Dyna® (except '16-'17 FXDLS) and '08-'15 Softail models (except '14-'15 FLSTNSE, '11-'12 FLSTSE and '13-'14 FXSBSE). All models require ECM calibration for proper installation. '17 models require recalibration with Screamin' Eagle Pro Street Tuner (sold separately).

29299-08A	Chrome.	\$351.95
------------------	---------	-----------------

29098-09A	Gloss Black.	\$351.95
------------------	--------------	-----------------

NOTE: The washable and rechargeable filter uses a special coating to help filter fine particles from the incoming air. With time, the oil in the filter will dissipate and the element will begin to turn gray. The original red color can be restored with an application of K&N® Air Filter Oil.



B. SCREAMIN' EAGLE HEAVY BREATHER PERFORMANCE AIR CLEANER KIT – CHROME

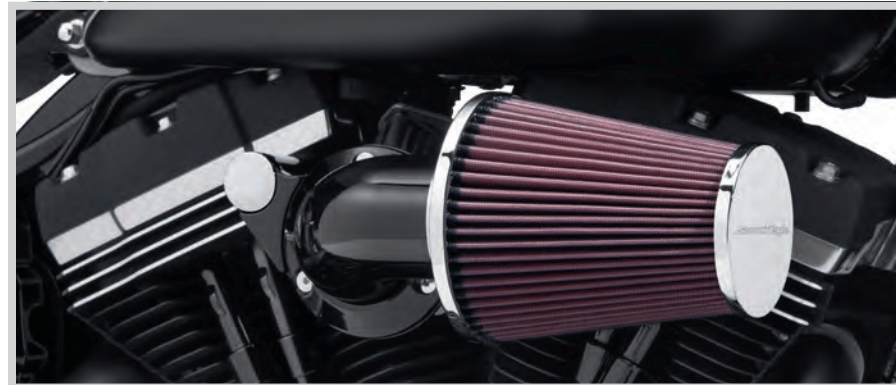

B. SCREAMIN' EAGLE HEAVY BREATHER PERFORMANCE AIR CLEANER KIT – GLOSS BLACK



B. SCREAMIN' EAGLE HEAVY BREATHER PERFORMANCE AIR CLEANER KIT – CHROME



B. SCREAMIN' EAGLE HEAVY BREATHER PERFORMANCE AIR CLEANER KIT – GLOSS BLACK

Street legal and/or street compliant statements refer to product meeting 50-State emissions and noise standards in the United States.

The street legal and/or street compliant statements may not apply to markets outside of the United States.

Notice: The prices appearing in this catalog are the manufacturer's suggested retail prices. Actual retail prices may vary.

374 SCREAMIN' EAGLE®

Twin Cam Stage I Upgrade

A. SCREAMIN' EAGLE® HEAVY BREATHER FILTER COVER – TEARDROP

Dress up the Heavy Breather Air Cleaner with this radical cover. Manufactured from forged aluminum and precision CNC-machined and polished, these easy-to-install two-piece covers add a rich custom look. Cover is available in mirror-chrome or cut back gloss black finish to match your customizing direction. Kit includes water-repellent rain sock.

Fits models equipped with Screamin' Eagle® Heavy Breather Air Cleaner Kits on Twin Cam and XL model. (except Compact Heavy Breather P/N 28716-10A, Heavy Breather Elite P/N 29400173, 29400172 or 29400285, and Milwaukee-Eight® Heavy Breather P/N 29400263 or 29400264).

29400061A	Cut Back Gloss Black – Side Logo.	\$185.95
28739-10A	Cut Back Gloss Black – End Logo.	\$185.95
28740-10A	Chrome – End Logo.	\$185.95



A. SCREAMIN' EAGLE HEAVY BREATHER FILTER COVER – TEARDROP, CUT BACK GLOSS BLACK – SIDE LOGO

B. SCREAMIN' EAGLE HEAVY BREATHER DECORATIVE ENDCAP – WILLIE G SKULL

Add a sinister touch to your Heavy Breather Air Cleaner. Chrome-plated self-adhesive cover features a forward-facing Willie G Skull medallion.

28720-10 **\$42.95**
Fits models equipped with Screamin' Eagle Heavy Breather Air Cleaner Kits (except Compact Heavy Breather P/N 28716-10A, Heavy Breather Elite P/N 29400173, 29400172 or 29400285, and Milwaukee-Eight Heavy Breather P/N 29400263 or 29400264).



A. SCREAMIN' EAGLE HEAVY BREATHER FILTER COVER – TEARDROP, CHROME

C. SCREAMIN' EAGLE HEAVY BREATHER DECORATIVE MEDALLION

Add the finishing touch to your Heavy Breather Air Cleaner by installing this medallion. Featuring a bright chrome-plated die-cast base and contrasting black inlay with diamond-cut Screamin' Eagle script. Easy to install.

29017-09 **\$27.95**
Fits models equipped with Screamin' Eagle Heavy Breather Air Cleaner Kits (except Compact Heavy Breather P/N 28716-10A, Heavy Breather Elite P/N 29400173, 29400172 or 29400285, and Milwaukee-Eight Heavy Breather P/N 29400263 or 29400264).



A. SCREAMIN' EAGLE HEAVY BREATHER FILTER COVER – TEARDROP, CUT BACK GLOSS BLACK

D. THROTTLE BODY COVER

This cover dresses the area between the Twin Cam cylinders for a custom look. The formed cover hugs the contour and conceals the electronic control module throttle body for a clean appearance. Available in your choice of mirror chrome or gloss black finish. Easy-to-install kit includes gaskets.

Fits '14-'15 FLSTNSE, '11-'12 FLSTSE, '13-'14 FXSBSE, and '16-'17 FXDLS and Softail®, '08-'16 Touring and Trike models equipped with Screamin' Eagle Heavy Breather or Burst Air Cleaner Kit.

61300109	Chrome.	\$65.95
61300110	Gloss Black.	\$65.95



B. SCREAMIN' EAGLE HEAVY BREATHER DECORATIVE ENDCAP – WILLIE G SKULL



C. SCREAMIN' EAGLE HEAVY BREATHER DECORATIVE MEDALLION



D. THROTTLE BODY COVERS



Street legal and/or street compliant statements refer to product meeting 50-State emissions and noise standards in the United States.

The street legal and/or street compliant statements may not apply to markets outside of the United States.

Notice: The prices appearing in this catalog are the manufacturer's suggested retail prices. Actual retail prices may vary.



E. SCREAMIN' EAGLE VENTILATOR ELITE AIR CLEANER KIT – CHROME



E. SCREAMIN' EAGLE VENTILATOR ELITE AIR CLEANER KIT – GLOSS BLACK



E. SCREAMIN' EAGLE VENTILATOR ELITE AIR CLEANER KIT



F. SCREAMIN' EAGLE VENTILATOR PERFORMANCE AIR CLEANER KIT – CHROME



F. SCREAMIN' EAGLE VENTILATOR PERFORMANCE AIR CLEANER KIT – GLOSS BLACK

SCREAMIN' EAGLE® 375

Twin Cam Stage I Upgrade

E. SCREAMIN' EAGLE® VENTILATOR ELITE AIR CLEANER KIT

This low-profile oval air cleaner features a 360° exposed filter element and a cast back plate designed to provide maximum airflow to the throttle body. This easy-to-install air cleaner produces significant performance gains, while the sleek center bar design cover with carbon fiber inserts add a luxurious touch. This complete kit includes low-profile air cleaner cover, high-flow filter element, back plate, diamond-cut Screamin' Eagle® medallion, protective rain sock and all required installation hardware. Street compliant when used with stock mufflers. 50-State U.S. EPA compliant.

Fits '16-'17 FXDLS and Softail® and '09-'16 Touring and Trike models. Also fits '11-'17 CVO™ Softail models. All EFI models require ECM calibration for proper installation. '17 models require recalibration with Screamin' Eagle Pro Street Tuner (sold separately).

29400217	Chrome.	\$319.95
29400218	Gloss Black.	\$319.95

Fits '16-'17 FXDLS and Softail, '14-'17 CVO Softail and '14-'16 Touring and Trike models equipped with Screamin' Eagle 58mm Throttle Body. All models require ECM calibration for proper installation. '17 models require recalibration with Screamin' Eagle Pro Street Tuner (sold separately).

29400219	Chrome.	\$319.95
29400230	Gloss Black.	\$319.95

Also available:

SCREAMIN' EAGLE VENTILATOR ELITE AIR CLEANER COVER

Add a luxurious finishing touch to your Ventilator Air Cleaner. Designed as a direct replacement for the Screamin' Eagle and CVO Ventilator Air Cleaners, this easy-to-install cover features a sleek center bar design surrounded with carbon fiber inserts. Kit includes low-profile cover, diamond-cut Screamin' Eagle medallion and chrome mounting hardware.

Fits '10-'17 Dyna®, '09-'16 Softail, '09-'16 Touring and Trike models equipped with Ventilator Air Cleaner Kits. Also fits Dyna High Output 103 and CVO models with Original Equipment Ventilator Air Cleaner.

61300516	Chrome.	\$121.95
61300517	Gloss Black.	\$121.95

F. SCREAMIN' EAGLE VENTILATOR PERFORMANCE AIR CLEANER KIT

Stylish low-profile exposed element air cleaner kit provides increased airflow to boost the power of your fuel-injected engine. The track-inspired exposed element adds a purposeful look to the bike and the included waterproof rain sock protects the filter during inclement weather. This easy-to-install kit includes low-profile air cleaner cover, high-flow filter element, back plate, Screamin' Eagle badge, protective rain sock and all required installation hardware. 50-State U.S. EPA compliant.

Fits '10-'17 Dyna (except '16-'17 FXDLS), and '10-'15 Softail models (except '14-'15 FLSTNSE, '11-'12 FLSTSE and '13-'14 FXSBSE). All models require ECM calibration for proper installation. '17 models require recalibration with Screamin' Eagle Pro Street Tuner (sold separately).

28721-10	Chrome.	\$266.95
28722-10	Gloss Black.	\$266.95

Street legal and/or street compliant statements refer to product meeting 50-State emissions and noise standards in the United States.

The street legal and/or street compliant statements may not apply to markets outside of the United States.

Notice: The prices appearing in this catalog are the manufacturer's suggested retail prices. Actual retail prices may vary.

376 SCREAMIN' EAGLE®

Twin Cam Stage I Upgrade

A. SCREAMIN' EAGLE® HIGH-FLOW AIR CLEANER – TWIN CAM

The High-Flow Air Cleaner Kit provides increased airflow to boost the power of your fuel-injected model. Kit features a one-piece cast back plate with integral breather and mounting brackets for simplified installation and a synthetic washable air cleaner element that does not require oiling. Available with a brilliant chrome or black back plate, this round air cleaner element can be dressed with most Original Equipment or accessory air cleaner covers. Or choose to flaunt your performance gains with the open element look, and finish it off with a Rain Sock Kit P/N 28728-10 and custom Air Cleaner Trim from one of the Harley-Davidson® decorative collections. This kit includes air cleaner, back plate, breather and all required hardware. 50-State U.S. EPA compliant.

Fits '16-'17 Softail® and '14-'16 Touring and Trike models (except CVO™ Touring) with Original Equipment 50mm Throttle Body. All models require ECM calibration for proper installation. '17 models require recalibration with Screamin' Eagle® Pro Street Tuner (sold separately).

29400234	Chrome.	\$196.95
29400233	Texture Black.	\$185.95

Fits '08-'15 Softail models (except CVO Softail). Also fits '08-'17 Dyna® models (except '16-'17 FXDLS) equipped with accessory Air Cleaner Cover. Also fits '04-'07 EFI Dyna, '01-'07 EFI Softail, and '02-'07 EFI Touring. FXS, FLS, FLSTSB and '13-'17 FXDB models require separate purchase of Gasket P/N 29591-99 and Screw P/N 29703-00. All models require ECM calibration for proper installation. '17 models require recalibration with Screamin' Eagle Pro Street Tuner (sold separately).

29400240	Chrome.	\$196.95
29400239	Texture Black.	\$185.95

Fits '08-'15 Dyna models with Original Equipment Teardrop Air Cleaner Cover. All models require ECM calibration for proper installation.

29400236	Chrome.	\$196.95
29400235	Texture Black.	\$185.95

Fits '08-'13 Touring and Trike models (except CVO Touring) with Original Equipment 50mm throttle body. All models require ECM calibration for proper installation.

29400238	Chrome.	\$196.95
29400237	Texture Black.	\$185.95

Fits '16-'17 FXDLS and Softail, '14-'17 CVO Softail, and '14-'16 Touring and Trike models equipped with Screamin' Eagle 58mm EFI Throttle Body. Requires separate purchase of an Accessory Air Cleaner Cover. All models require ECM calibration for proper installation. '17 models require recalibration with Screamin' Eagle Pro Street Tuner (sold separately).

29400222	Raw Aluminium.	\$185.95
-----------------	----------------	-----------------



A. HIGH-FLOW AIR CLEANER KIT – CHROME (29400234 SHOWN)



A. HIGH-FLOW AIR CLEANER KIT – BLACK (29400233 SHOWN)



B. EXTREME BILLET AIR CLEANER KIT – AGITATOR, CHROME



B. EXTREME BILLET AIR CLEANER KIT – AGITATOR, CUT BACK GLOSS BLACK



A. HIGH-FLOW AIR CLEANER KIT – BLACK (29400239 SHOWN)



A. HIGH-FLOW AIR CLEANER KIT – CHROME (29400240 SHOWN)



B. EXTREME BILLET AIR CLEANER KIT – CHISEL, CHROME



B. EXTREME BILLET AIR CLEANER KIT – CHISEL, CUT BACK GLOSS BLACK



A. HIGH-FLOW AIR CLEANER KIT – BLACK (29400235 SHOWN)



A. HIGH-FLOW AIR CLEANER KIT – CHROME (29400236 SHOWN)



B. EXTREME BILLET AIR CLEANER KIT



B. EXTREME BILLET AIR CLEANER KIT (SHOWN WITH RAIN SOCK)

SCREAMIN' EAGLE® 377

Twin Cam Stage I Upgrade

B. SCREAMIN' EAGLE® EXTREME BILLET AIR CLEANER KIT

The forged billet aluminum cover tops off a cast back plate with integral breather for a smooth transition to the throttle body. The race-inspired air cleaner is engineered to flow high volumes of air and the washable pleated element provides the ideal combination of efficiency and engine protection. Available in your choice of style and finish, this easy-to-install kit includes all mounting hardware and rain sock. 50-State U.S. EPA compliant.

Fits '16-'17 FXDLS and Softail® and '08-'16 Touring and Trike models with Original Equipment 50mm Throttle Body. All models require ECM calibration for proper installation. '17 models require recalibration with Screamin' Eagle® Pro Street Tuner (sold separately).

29400064	Agitator – Chrome.	\$409.95
29400063	Agitator – Cut Back Gloss Black.	\$409.95
29400104	Chisel – Chrome.	\$409.95
29400103	Chisel – Cut Back Gloss Black.	\$409.95

Fits '16-'17 FXDLS and Softail, '14-'17 CVO™ Softail and '14-'16 Touring and Trike models equipped with Screamin' Eagle 58mm Throttle Body. All models require ECM calibration for proper installation. '17 models require recalibration with Screamin' Eagle Pro Street Tuner (sold separately).

29400221	Chisel – Chrome.	\$409.95
29400220	Chisel – Cut Back Gloss Black.	\$409.95

Fits '08-'17 Dyna® (except '16-'17 FXDLS), and '08-'15 Softail models (except '14-'15 FLSTNSE, '11-'12 FLSTSE and '13-'14 FXSBSE). All models require ECM calibration for proper installation. '17 models require recalibration with Screamin' Eagle Pro Street Tuner (sold separately).

29400116	Chisel – Cut Back Gloss Black.	\$409.95
29400117	Chisel – Chrome.	\$409.95

NOTE: The washable and rechargeable filter uses a special coating to help filter fine particles from the incoming air. With time, the oil in the filter will dissipate and the element will begin to turn gray. The original red color can be restored with an application of K&N® Air Filter Oil.

Street legal and/or street compliant statements refer to product meeting 50-State emissions and noise standards in the United States.

The street legal and/or street compliant statements may not apply to markets outside of the United States.

Notice: The prices appearing in this catalog are the manufacturer's suggested retail prices. Actual retail prices may vary.

Street legal and/or street compliant statements refer to product meeting 50-State emissions and noise standards in the United States.

The street legal and/or street compliant statements may not apply to markets outside of the United States.

Notice: The prices appearing in this catalog are the manufacturer's suggested retail prices. Actual retail prices may vary.

378 SCREAMIN' EAGLE®

Twin Cam Stage I Upgrade

A. SCREAMIN' EAGLE® AIR CLEANER TRIM

Dress your air cleaner in the traditional H-D orange and black. Easy-to-install trim features Screamin' Eagle® script set against a gloss black background.

61300299 \$23.95

Fits '16-'17 Softail® (except FLSTFBS and FXSE) and '14-'16 Touring and Trike models with Original Equipment air cleaner cover. Does not fit CVO™ models.

29503-07 \$18.95

Fits '07 Dyna®, '07-'15 Softail (except FLSTSB and FXS), '07-'13 Touring and Trike models models with Original Equipment air cleaner cover.



A. SCREAMIN' EAGLE AIR CLEANER TRIM (61300299 SHOWN)



A. SCREAMIN' EAGLE AIR CLEANER TRIM (29503-07 SHOWN)

C. SCREAMIN' EAGLE AIR CLEANER BACK PLATE KITS

Finished in brilliant chrome or wrinkle black, these replacement back plates complement the finish of your engine. Cast back plate design features integral breather and mounting brackets for simplified installation.

Fits models equipped with Screamin' Eagle High-Flow Air Cleaner Kits. Installation may require separate purchase of (2) O-Ring P/N 11292, (2) Breather Tube P/N 29557-05 and (2) Breather Screw P/N 29465-99. See your Dealer for details.

Fits '99-'07 Dyna, '99-'15 Softail (except '11-later CVO) and '02-'07 Touring models.

29510-05 Chrome. \$64.95

29586-06 Wrinkle Black. \$54.95

Fits '08-'15 Dyna®, '08-'13 Touring and Trike models with Original Equipment Teardrop Air Cleaner Cover.

29624-08 Chrome. \$64.95

29319-08 Wrinkle Black. \$54.95

Fits '08-'17 Dyna models (except '16-'17 FXDLS) with Original Equipment Teardrop Air Cleaner Cover.

29170-08 Chrome. \$64.95

29119-08 Wrinkle Black. \$54.95



B. SCREAMIN' EAGLE AIR CLEANER RAIN SOCK (SHOWN WITH #1 SKULL AIR CLEANER TRIM)



C. SCREAMIN' EAGLE AIR CLEANER BACK PLATE KITS

Street legal and/or street compliant statements refer to product meeting 50-State emissions and noise standards in the United States.

The street legal and/or street compliant statements may not apply to markets outside of the United States.

Notice: The prices appearing in this catalog are the manufacturer's suggested retail prices. Actual retail prices may vary.



D. SCREAMIN' EAGLE STREET PERFORMANCE SLIP-ON SHORTY DUAL MUFFLERS – JET BLACK WITH MUFFLER SHIELDS (SHOWN WITH JET BLACK EXHAUST SHIELD KIT)



E. SCREAMIN' EAGLE STREET CANNON SLIP-ON MUFFLERS – SOFTAIL SHOTGUN, JET BLACK (SHOWN WITH JET BLACK SLASH END CAPS AND EXHAUST SHIELDS)



F. SCREAMIN' EAGLE STREET CANNON SLIP-ON MUFFLERS – SOFTAIL SHORTY DUAL, JET BLACK (SHOWN WITH SATIN BLACK END CAPS AND JET BLACK EXHAUST SHIELDS)



G. MUFFLER END CAPS – 3.25"

SCREAMIN' EAGLE® 379

Twin Cam Stage I Upgrade

D. SCREAMIN' EAGLE® STREET PERFORMANCE SLIP-ON MUFFLERS – DYNA® SHORTY DUAL

Factory engineers tuned these pipes to satisfy the most discriminating Harley enthusiast. Mufflers feature high-flowing internals to maximize performance and a rich, deep exhaust note that lets everyone know you're around. With the aggressive sound quality and performance comparable to Screamin' Eagle® II race-use mufflers, it's hard to believe they are street compliant. Available in your choice of rich chrome or heat-resistant jet black ceramic finish. Jet black mufflers include matching muffler shield with a deep embossed Screamin' Eagle logo along the flank. Chrome mufflers allow for the reuse of stock muffler shields or the separate purchase of Chrome Screamin' Eagle® Script Muffler Shields. 50-State U.S. EPA compliant.

80794-10A Jet Black w/ Muffler Shields. \$530.95

Fits '07-'17 FXDB, '07-'10 FXD, '07-'14 FXDL, '07-'13 FXDL and '07-'08 FXDWG models with Shorty Dual exhaust. Installation requires separate purchase of Muffler Clamps P/N 65296-95A (Qty 2). All models require ECM calibration for proper installation. '17 models require recalibration with Screamin' Eagle Pro Street Tuner (sold separately).

E. SCREAMIN' EAGLE STREET CANNON SLIP-ON MUFFLERS – SOFTAIL® SHOTGUN

These 3.25" street compliant high-flow mufflers have been specifically tuned to deliver an aggressive exhaust note and improved performance while preserving the peace with your neighbors. Available in your choice of rich chrome or heat resistant jet black ceramic finish. The Jet Black mufflers include Screamin' Eagle® muffler shields. Complete the look with your choice of 3.25" endcaps (sold separately). 50-State U.S. EPA compliant.

64900334 Jet Black w/ Muffler Shields. \$629.95

Fits '07-'17 FLS, FLSTN and FLSTSB models equipped with Shotgun exhaust. Does not fit FLSS. Installation requires separate purchase of 3.25" End Caps and Muffler Clamps P/N 65296-95A (Qty 2). All models require ECM calibration for proper installation. '17 models require recalibration with Screamin' Eagle Pro Street Tuner (sold separately).

64900341 Jet Black w/ Muffler Shields. \$558.95

Fits '07-'17 FLSTF, FLSTFB and FXS models equipped with Shotgun exhaust. Installation requires separate purchase of 3.25" End Caps and Muffler Clamps P/N 65296-95A (Qty 2). All models require ECM calibration for proper installation. '17 models require recalibration with Screamin' Eagle Pro Street Tuner (sold separately).

F. SCREAMIN' EAGLE STREET CANNON SLIP-ON MUFFLERS – SOFTAIL SHORTY DUAL

These 3.25" street compliant high-flow mufflers have been specifically tuned to deliver an aggressive exhaust note and improved performance while preserving the peace with your neighbors. Available in your choice of rich chrome or heat resistant jet black ceramic finish. The Jet Black mufflers include Screamin' Eagle muffler shields. Complete the look with your choice of 3.25" endcaps (sold separately). 50-State U.S. EPA compliant.

64900343 Jet Black w/ Muffler Shields. \$530.95

Fits '07-'17 FLSTC and FXSB models equipped with Staggered Shorty Dual exhaust. Installation requires separate purchase of 3.25" End Caps and Muffler Clamps P/N 65296-95A (Qty 2). All models require ECM calibration for proper installation. '17 models require recalibration with Screamin' Eagle Pro Street Tuner (sold separately).

G. MUFFLER END CAPS – 3.25"

These easy-to-install caps allow you to finish your 3.25" Screamin' Eagle mufflers your way. Sold in pairs. Installation hardware included.

Fits '14-'22 XL and '07-'17 Softail® models equipped with Screamin' Eagle 3.25" Street Cannon Mufflers.

65100044 Chrome – Slash Up/Down/Out. \$107.95

65100063 Jet Black – Slash Up/Down/Out. \$118.95

Street legal and/or street compliant statements refer to product meeting 50-State emissions and noise standards in the United States.

The street legal and/or street compliant statements may not apply to markets outside of the United States.

Notice: The prices appearing in this catalog are the manufacturer's suggested retail prices. Actual retail prices may vary.

380 SCREAMIN' EAGLE®

Twin Cam Stage I Upgrade

A. JET BLACK EXHAUST SHIELD KIT – DYNA® SHORTY DUAL

Extend the custom look along the bike's entire profile. These formed steel exhaust shields are available in a unique jet black ceramic finish that complements jet black Screamin' Eagle® Street Performance Slip-On Mufflers. This exhaust shield kit has survived stringent Harley-Davidson testing for durability and corrosion resistance. Manufactured to Original Equipment standards for exact fit, the easy-to-install kit includes front and rear head pipe shields.

80821-10 \$161.95
Fits '06-'10 FXD, '06-'17 FXDB, '06-'14 FXDC, '06-'13 FXDL and '06-'08 FXDWG models with shorty dual exhaust.



A. JET BLACK EXHAUST SHIELD KIT



B. JET BLACK EXHAUST SHIELD KIT – DYNA STAGGERED DUAL

B. JET BLACK EXHAUST SHIELD KIT – DYNA STAGGERED DUAL

Add a custom touch to your ride. These formed steel exhaust shields are available in a tough jet black ceramic that looks just right when paired with jet black Screamin' Eagle Street Performance Slip-On Mufflers. The jet-black coating adds a sinister look to your bike's profile. The slotted "Tommy gun" cutouts expose the head pipe for a raw, rebellious attitude. Manufactured to Original Equipment standards for exact fit, this easy-to-install kit includes front and rear head pipe shields.

65247-09 \$245.95
Fits '08-'17 FXDF and '10-'17 FXDWG models with forward controls.

C. SCREAMIN' EAGLE® SLASH CUT MUFFLER SHIELDS – SATIN BLACK

Shaped to mirror the slash down profile of available muffler end caps, this set of rich satin black Muffler Shields is the perfect complement to your blacked-out exhaust system. The rear shield features a subtle laser-etched Screamin' Eagle script. Easy-to-install kit includes front and rear shields and black mounting hardware.

65400405 Satin Black. \$139.95
Fits '07-'22 XL, '07-'17 Dyna® (except '08-'17 FLD, FXDF, FXDL, FXDLS and '10-'17 FXDWG) and '07-'17 Softail® models equipped with Screamin' Eagle Street Performance mufflers.



C. SCREAMIN' EAGLE SLASH CUT MUFFLER SHIELDS – SATIN BLACK



D. SCREAMIN' EAGLE SLASH CUT MUFFLER SHIELDS – CHROME

D. SCREAMIN' EAGLE SLASH CUT MUFFLER SHIELDS – CHROME

Styled to complement the ballistic inlet shape of the Screamin' Eagle Street Performance Slip-On Mufflers. The slash-cut rear shield features a laser-etched Screamin' Eagle signature script. Easy-to-install kit includes front and rear shields and mounting hardware.

65400464 Chrome. \$83.95
Fits '07-'22 XL, '07-'17 Dyna (except '08-'17 FLD, FXDF, FXDL, FXDLS and '10-'17 FXDWG) and '07-'17 Softail models equipped with Screamin' Eagle Street Performance Mufflers.

E. JET BLACK EXHAUST SHIELD KIT – TOURING

Available for 2-into-1 and 2-into-2 exhaust systems, these formed steel exhaust shields feature a unique jet black ceramic coating that complements the jet black Screamin' Eagle Street Cannon Slip-On Mufflers. The jet black coating maintains its uniform black finish and has survived stringent Harley-Davidson testing for durability and corrosion resistance. Manufactured to Original Equipment standards for exacting fit, the easy-to-install kit includes front and rear head pipe shields.

64981-09 \$283.95
Fits '09-'16 Touring and Trike models (except '10 FLHX and FLTRX).



E. JET BLACK EXHAUST SHIELD KIT – TOURING

Street legal and/or street compliant statements refer to product meeting 50-State emissions and noise standards in the United States.

The street legal and/or street compliant statements may not apply to markets outside of the United States.

Notice: The prices appearing in this catalog are the manufacturer's suggested retail prices. Actual retail prices may vary.



F. SCREAMIN' EAGLE STREET CANNON PERFORMANCE MUFFLERS – CHROME (SHOWN WITH BILLET TAPERED SLASH END CAPS)



F. SCREAMIN' EAGLE STREET CANNON PERFORMANCE MUFFLERS – JET BLACK (SHOWN WITH BLUNT REVOLVER END CAPS)



G. MUFFLER END CAPS – 4"



H. SHORT SLASH UP/DOWN/OUT – 4" MUFFLER END CAPS



I. MUFFLER BRACKET COVER KIT – CHROME

SCREAMIN' EAGLE® 381

Twin Cam Stage I Upgrade

F. SCREAMIN' EAGLE® STREET CANNON PERFORMANCE SLIP-ON MUFFLERS – 4.0"

Cue the orchestra. We tuned these mufflers to provide an exhaust note with some extra deep bass. You get the rumble you want and enhance that famous Harley sound, while preserving the peace with your neighbors. The tuned baffles work with the large internal volume to strike the perfect balance required to deliver performance that you can feel in your gut. The large 4.0" diameter Street Cannons provide free flow of exhaust gases with just the right amount of back pressure for a smooth-running ride. The die-cast Screamin' Eagle® medallion adds a rich touch to your bike's profile and a large selection of end cap designs are available (sold separately) to provide the perfect finishing touch. 50-State U.S. EPA compliant.

Fits '09-'16 Touring and '09-later Trike models (except CVO™ models and '10 FLHX and FLTRX models). Installation requires separate purchase of 4" end caps and Muffler Clamps P/N 65296-95A (Qty 2). All models require ECM calibration for proper installation. '17-later Trike models require recalibration with Screamin' Eagle Pro Street Tuner (sold separately).

64900186B Chrome. \$452.95
64900187B Jet Black. \$504.95

G. MUFFLER END CAPS – 4"

These End Cap Kits allow you to personalize your Screamin' Eagle Street Performance Touring Mufflers. Available in your choice of styles, these easy-to-install caps are dressed with the same finish as the mufflers and exhaust shields for a consistent look front to back. Sold in pairs, the kit includes all required mounting hardware.

Fits '09-'16 Touring and '09-later Trike models equipped with Screamin' Eagle Street Cannon 4" End Cap Mufflers. Does not fit 4" CVO Touring mufflers.

65100016 Revolver. \$116.95
65100019 Slash Up/Down/Out. \$116.95
65100017 Fishtail. \$168.95
80611-09 Blunt Revolver. \$147.95

H. SHORT SLASH UP/DOWN/OUT 4" MUFFLER END CAPS

These End Cap Kits allow you to personalize your Screamin' Eagle Street Performance Touring Mufflers. The Short Slash Up/Down/Out End Caps are 2" shorter than our traditional Slash Cut End Caps, and keep the mufflers tucked in close to the saddlebag or Trike model rear valance for a clean custom look. Sold in pairs, the kit includes all required mounting hardware.

65100062 \$104.95
Fits '09-'16 Touring and '09-later Trike models equipped with Screamin' Eagle Street Cannon 4" End Cap Mufflers. Does not fit 4" CVO™ Touring mufflers.

I. MUFFLER BRACKET COVER KIT

Stamped-steel cover conceals the Original Equipment exhaust brackets. Contoured for a custom fit, these easy-to-install covers add a distinctive finishing touch. Available in mirror-chrome or black finish to match your customizing style (sold in pairs).

80716-08 Chrome. \$64.95
Fits '97-'13 Touring models. Fits Screamin' Eagle Street Performance Touring 4" Mufflers (except P/N 64900093 and 64900091). Does not fit with Fishtail 4.0" Muffler End Cap P/N 65100017. Does not fit with Screamin' Eagle 3.5" Mufflers.

NOTE: There is no warranty on exhaust pipes and mufflers with regard to any discoloration. Blueing is caused by tuning characteristics, cam timing, carburetor jetting, over-heating, etc. and is not caused by defective manufacturing.

Street legal and/or street compliant statements refer to product meeting 50-State emissions and noise standards in the United States.

The street legal and/or street compliant statements may not apply to markets outside of the United States.

Notice: The prices appearing in this catalog are the manufacturer's suggested retail prices. Actual retail prices may vary.

TWIN CAM STAGE II UPGRADE

Camshafts are a fundamental ingredient in the performance recipe, because they control the timing and duration of all major engine events. They are the primary means by which you can tune your engine's horsepower and torque output. Every cam has unique lift and overlap performance characteristics, which means you need to select cams based on exactly the kind of power you're looking for.



A. SCREAMIN' EAGLE® TWIN CAM PERFORMANCE CAMS

Kits include front and rear cams. Splined rear cam is included for exceptional load handling capability. Gaskets and bearings not included. Cam Installation Kit P/N 17045-99C (sold separately) includes all required gaskets, bearings and seals for proper installation. Dealer installation is recommended and special tools are required for proper installation.

SE-255 CAM KIT

The ultimate in torque cams, this cam offers substantial increase in low end torque for engines up to 110 cubic inches with compression ratios up to 10 to 1. The low end torque increases are great for heavy bikes or for the person who routinely shifts below 4500 RPM and wants the power available to pass without downshifting. The cam still makes peak power above 5000 RPM so people with lighter bikes will enjoy the torque increases without feeling like the bike runs out of air at higher engine speeds. 50-State U.S. EPA compliant.

25638-07 **\$383.95**

For use on '09-'13 Dyna®, Softail®, and '09-'13 Touring and Trike models with 103CI and 110CI engines. All models require ECM calibration for proper installation. Labor cost not included. See Dealer for details.

SE-259E CAM KIT

Developed specifically for big displacement Twin Cam engines, this cam has a modern lobe design that allows for higher valve lifts for a given duration. A high-lift version of the SE-211 camshaft, this cam works great with 103-cubic-inch and larger engines with free-flowing intake and exhaust. It can be used with stock heads (updated with race springs) and high-compression pistons for even more torque than a SE-211 cam or can be coupled with any of the performance heads to realize the full power potential. 50-State U.S. EPA compliant.

25482-10 **\$383.95**

For use on '11-'15 103CI and 110CI Touring and Trike models. Installation requires separate purchase of Performance Valve Spring Kit P/N 18013-03A. All models require ECM calibration for proper installation. Labor cost not included. See Dealer for details.

SE-585 CAM KIT

This cam is a great match for riders of heavy Touring bikes looking for big torque at the low end. Just a quick downshift to fourth gear results in an effortless pass of that slow-moving tractor-trailer ahead of you. This cam provides an early hit of torque at the low end of the RPM spectrum. A unique combination of lift, cam lobe duration and an enhanced cam profile ramp provides a performance boost you can feel. The cam's QRD (Quiet Ramp Design) delivers high torque throughout the RPM range while reducing valve train noise. 50-State U.S. EPA compliant.

25400117 **\$383.95**

For use on '14-'16 Touring models with the use of a 58mm Throttle Body. Also fits '14-'16 CVO™ Touring models with or without the use of a 58mm Throttle Body. Does not fit Trike models. Installation requires separate purchase of Performance Valve Spring Kit P/N 18013-03A. All models require ECM calibration for proper installation. Labor cost not included. See Dealer for details.

NOTE: Separate purchase of Cam Drive Retention Kit P/N 25566-06 and Cam Spacer Kit P/N 25928-06 may be required. These kits contain five different spacers to achieve proper sprocket alignment. Individual spacers can be purchased separately.

Street legal and/or street compliant statements refer to product meeting 50-State emissions and noise standards in the United States.

The street legal and/or street compliant statements may not apply to markets outside of the United States.

Notice: The prices appearing in this catalog are the manufacturer's suggested retail prices. Actual retail prices may vary.

Twin Cam 103CI Stock vs. 103CI Stage II with SE-255 Cam

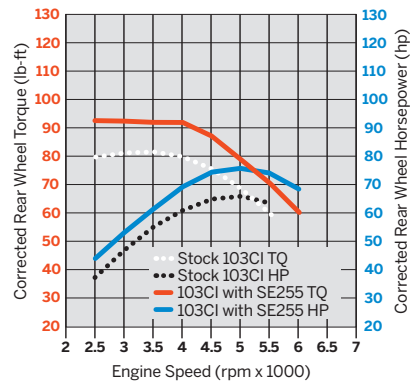

Twin Cam 103CI Stock vs. 103CI Stage II with SE-259E Cam

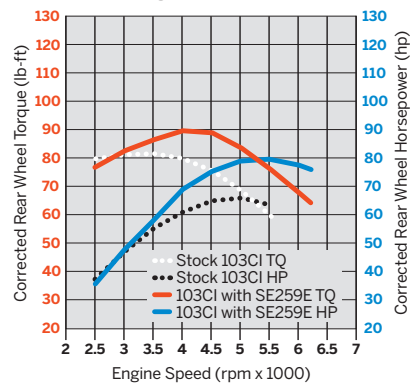

Twin Cam HO103CI Stock vs. 103CI Stage II with SE-585 Cam

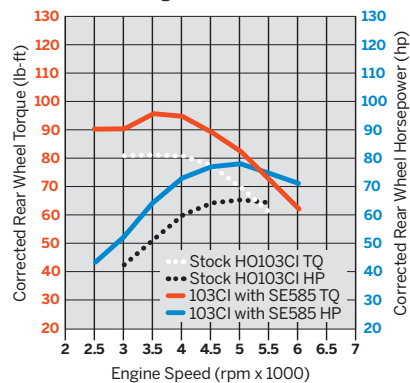

B. SCREAMIN' EAGLE PREMIUM TAPERED QUICK-INSTALL ADJUSTABLE PUSHRODS – CHROME COVERS



C. SCREAMIN' EAGLE HIGH-CAPACITY TAPPETS



E. PUSHROD COVER KIT – GLOSS BLACK



B. SCREAMIN' EAGLE PREMIUM TAPERED QUICK-INSTALL ADJUSTABLE PUSHRODS – GLOSS BLACK COVERS



D. SCREAMIN' EAGLE PERFORMANCE VALVE SPRING KIT



F. PUSHROD TUBE COLLARS – GLOSS BLACK

Twin Cam Stage II Upgrade

B. SCREAMIN' EAGLE® PREMIUM TAPERED QUICK-INSTALL ADJUSTABLE PUSHRODS

These premium pushrods are tapered for enhanced clearance at the cylinder head, allowing the use of higher lift cams. The one-piece chrome moly tube adds rigidity and durability and the threaded adjustment feature provides easy cam installation without removing the cylinder heads or rocker boxes. To simplify adjustment, the tube features six flats, with one flat marked with a large dot for tracking the adjustment. The threaded rod features 4 flats to reduce wrench swing. Each pushrod features the Screamin' Eagle® logo and is marked for "Intake" or "Exhaust." Kit includes 4 pushrods and required pushrod tubes.

Fits '99-'17 Twin Cam-equipped models.

17900032 With Gloss Black Covers. **\$270.95**

18404-08 With Chrome Covers. **\$260.95**

C. SCREAMIN' EAGLE HIGH-CAPACITY TAPPETS

Screamin' Eagle Tappets feature large high-capacity needles in the roller bearing assembly to improve reliability when operating with high-lift cams, high-pressure valve springs and in high-RPM applications. The 25% larger needle bearings increase the dynamic load rating by approximately 20% when compared to the Original Equipment Twin Cam tappets. The unique design delivers superior tappet life in performance applications. Set of 4.

18572-13 **\$274.95**

Fits '17-later Milwaukee-Eight® Engine equipped models, '00-'22 XL and XR models and '99-'17 Twin Cam-equipped models.

D. SCREAMIN' EAGLE PERFORMANCE VALVE SPRING KIT*

This performance beehive-shaped Valve Spring Kit will permit the Sportster® engine to rev to 7000 RPM. The unique ovate wire yields increased performance from a compact spring design. The installed spring pressure is increased to 208 lbs and allows a maximum lift of .590". Complete kit includes springs, upper collars and keepers and lower collars with integral valve seals.

18013-03A **\$175.95**

Fits '04-'22 XL, XR and '05-'17 Twin Cam-equipped models. Does not fit FXDLS, FLSS, FLSTFBS or Screamin' Eagle Performance Heads with .3125" diameter valves.

E. PUSHROD COVER KIT – GLOSS BLACK

Complete the Dark Custom look. These covers replace existing chrome covers to give your bike a blacked-out appearance down to the smallest detail. Pushrod covers are finished in gloss black and the kit includes four bottom cover tubes and the four upper clips. Installation retains the Original Equipment chrome short center tube to create a high-contrast accent. Cover Kit can be installed on engines already equipped with Adjustable Pushrods or can be installed by removing rocker box covers, rocker arms and non-adjustable pushrods. Consult your dealer or service manual for installation.

17900033 Covers Only. **\$76.95**

Fits '99-'17 Twin Cam-equipped models. Requires prior installation of Adjustable Pushrods or removal of rocker box covers, rocker arms and fixed-length pushrods.

F. PUSHROD TUBE COLLARS – GLOSS BLACK

Manufactured from Original Equipment components for perfect fit and function, these Pushrod Collars complete your Twin Cam engine's conversion to the total blacked-out look. Covers replace the chrome-finished factory covers, and fit with stock or Screamin' Eagle Quick-Install Pushrods.

17900076 **\$38.95**

Fits '84-'00 Evolution® 1340 and '99-'17 Twin Cam-equipped models. Installation requires use of Adjustable Pushrods or removal of rocker box covers, rocker arms and fixed-length pushrods.

***CAUTION:** Proper valve spring to rocker cover clearance must always be verified during installation of Screamin' Eagle Valve Spring Kits. Failure to have adequate clearance may result in engine damage.

Street legal and/or street compliant statements refer to product meeting 50-State emissions and noise standards in the United States.

The street legal and/or street compliant statements may not apply to markets outside of the United States.

Notice: The prices appearing in this catalog are the manufacturer's suggested retail prices. Actual retail prices may vary.

384 SCREAMIN' EAGLE®

Twin Cam Stage II Upgrade

A. SCREAMIN' EAGLE® BILLET CAM SUPPORT PLATE WITH HIGH-VOLUME OIL PUMP

A great upgrade for any performance motor. The Billet Cam Support Plate is manufactured from billet aluminum with pressed-in bronze bushings and is pre-assembled with the crankshaft bushing and oil pressure relief valve. Aluminum is specified at 6061 billet plate, heat-treated to T6 specifications with a surface-hardened anodized finish to provide superior strength, rigidity and durability. CNC-precision machining ensures precise dimensions and constant material thickness across the plate, enabling perfect alignment of cams and chains. Cam bushings are made from 660 bronze materials to provide enhanced wear resistance and to stand up to increased loads from the high lift cams common in large displacement motors. The improved Screamin' Eagle® high-flow oil pump provides higher pressure when the oil is hot to keep pressure drops to a minimum and increases the oil supply by 16% and the scavenging by 29% over the '06-'17 Original Equipment oil pump.

25282-11 **\$481.95**

Fits '06-'17 Dyna® and '07-'17 Softail®, and '07-'16 Touring and Trike models. Installation requires separate purchase of Cam Service Kit P/N 17045-99D and Drive Gear Retention Kit P/N 25566-06.



A. SCREAMIN' EAGLE BILLET CAM SUPPORT PLATE WITH HIGH-VOLUME OIL PUMP

B. SCREAMIN' EAGLE HYDRAULIC CAM CHAIN TENSIONER AND HIGH-FLOW OIL PUMP UPGRADE KIT

This kit updates the cam chain tensioner of your Twin Cam 88® engine to the latest design, as featured on the Twin Cam 96™ engine. The billet cam support plate has been designed to allow the installation of the Twin Cam 96 hydraulic cam chain tensioner to Twin Cam 88-equipped models. These Hydraulic Cam Chain Tensioners will significantly outlast the spring-loaded tensioners and are an ideal addition to an engine modified for improved performance. In addition, '02-'06 models utilize a Twin Cam 96 single row front roller chain and sprocket (included in kit). '99-'01 models use Original Equipment front silent chain and sprocket to retain the cam position sensor function. The kit includes an improved Screamin' Eagle High-Flow Oil Pump that provides increased oil pressure at high operating temperatures. This kit increases the oil supply by 23% and scavenging by 50% when compared to the '99-'05 Original Equipment oil pump and reduces operating temperature of bearings to improve bearing life.

25284-11 **\$559.95**

Fits '99-'05 Dyna, '00-'06 Softail and '99-'06 Touring models. Installation requires separate purchase of Spacer Kit P/N 25285-08, Cam Service Kit P/N 17045-99D and Drive Gear Retention Kit P/N 25566-06.



B. SCREAMIN' EAGLE HYDRAULIC CAM CHAIN TENSIONER AND HIGH-FLOW OIL PUMP UPGRADE KIT

C. SCREAMIN' EAGLE HIGH-PERFORMANCE INNER CAM BEARINGS

High-performance Inner Cam Bearings are a smart upgrade when installing high-lift cams in a race bike. These bearings provide increased load capacity and extend the engine life in extreme racing conditions. Kit includes two bearings required to complete one Twin Cam engine.

24017-10 **\$28.95**

Fits '99-'05 Dyna, '00-'06 Softail and '99-'06 Touring models.

24018-10 **\$28.95**

Fits '06-'17 Dyna, '07-'17 Softail and '07-'16 Touring and Trike models.



New Pump Rotor

Original Pump Rotor

HIGH VOLUME OIL PUMP COMPARISON

C. SCREAMIN' EAGLE HIGH-PERFORMANCE INNER CAM BEARINGS

Street legal and/or street compliant statements refer to product meeting 50-State emissions and noise standards in the United States.

The street legal and/or street compliant statements may not apply to markets outside of the United States.

Notice: The prices appearing in this catalog are the manufacturer's suggested retail prices. Actual retail prices may vary.

SCREAMIN' EAGLE® 385

STAGE III & IV UPGRADES

Screamin' Eagle® Stage Kits offer complete street-compliant performance configurations engineered to help you generate specific torque and horsepower gains. Eliminating all the guesswork and trial-and-error testing normally associated with engine modifications, Stage Kits include everything you need to enhance your bike's performance, including big-bore cylinders, high-compression pistons, performance cams and high-flow air cleaners.

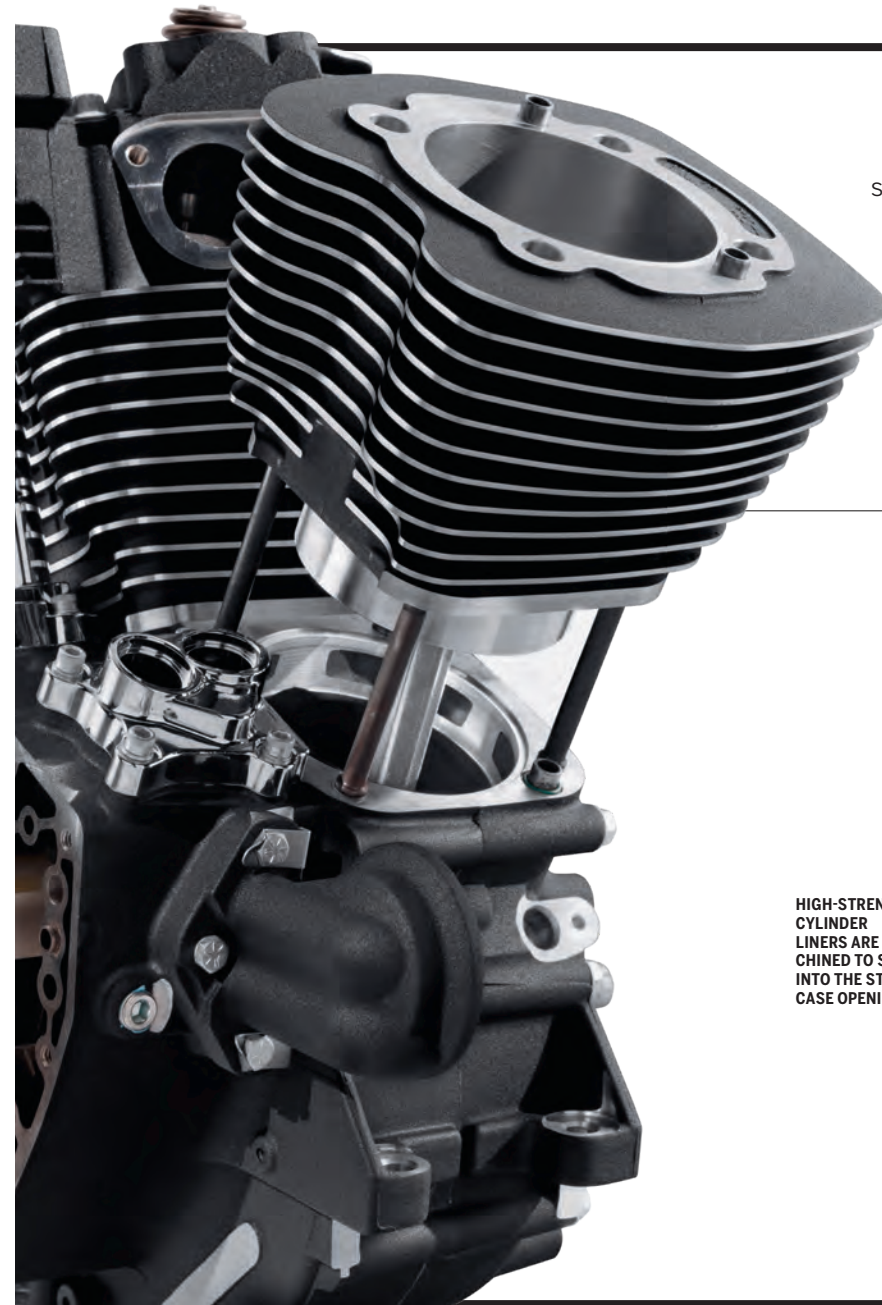

BOLT-ON TWIN CAM 10 BIG BORE STAGE KITS

HIGH-STRENGTH CYLINDER LINERS ARE MACHINED TO SLIP INTO THE STOCK CASE OPENING



FEATURES

BOLT-ON BIG BORE CYLINDERS

In the past, the only way to increase the bore of your 103- or 110-cubic-inch Twin Cam V-Twin motor was to tear down the motor and re-bore the engine cases to fit larger bore cylinder spigots. It was a labor-intensive and expensive process. The Screamin' Eagle team has engineered a 4" Big Bore Cylinder and Piston package that increase the internal bore from 3-7/8" to 4", without increasing the outside diameter of the cylinder spigot. The cylinder slips into the existing case bore without modification.

Street legal and/or street compliant statements refer to product meeting 50-State emissions and noise standards in the United States.

The street legal and/or street compliant statements may not apply to markets outside of the United States.

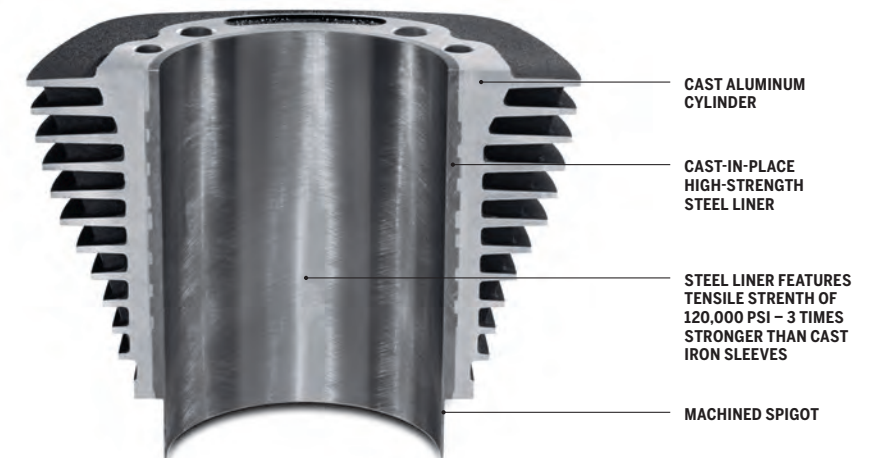

CAST ALUMINUM CYLINDER

CAST-IN-PLACE HIGH-STRENGTH STEEL LINER

STEEL LINER FEATURES TENSILE STRENGTH OF 120,000 PSI – 3 TIMES STRONGER THAN CAST IRON SLEEVES

MACHINED SPIGOT

SCREAMIN' EAGLE

386 SCREAMIN' EAGLE®

Twin Cam Stage III Upgrade

STAGE III

SCREAMIN' EAGLE® TWIN CAM HIGH-COMPRESSION KIT WITH CAMS – 103CI TO 103CI

Give your Touring bike the kick it needs to pass a road-hogging RV on a long uphill climb. This street compliant Stage III "in-a-box" kit includes the system-matched components you need to build a performance Twin Cam engine with torque and horsepower characteristics you can use – every day. Designed for use with stock cylinder heads, this kit produces big torque gains at lower RPM while maintaining your factory warranty. This street-performance engine has the potential to produce 88hp and 100 lb-ft of torque with the stock cylinder heads. 50-State U.S. EPA compliant.

Kit includes:

- Forged 10.5:1 High Compression Pistons and Rings
- SE-585 Cams
- High Performance Valve Springs
- Perfect-Fit Pushrods
- Top End Gasket Kit
- Heavy Duty Clutch Spring

92500028 **\$1,059.95**

Fits '14-'16 Touring models. Does not fit Trike or models with Twin-Cooled™ engines. Requires separate purchase of outer Primary Cover Gasket. Installation requires separate purchase of Cam Drive Retention Kit P/N 25566-06. May require Cam Spacer Kit P/N 25928-06. All models require ECM calibration for proper installation.

NOTICE: Installation of automatic or manual compression releases on large displacement engines is highly recommended.

When installed by an authorized Harley-Davidson® Dealer within 60 days of the vehicle purchase, compliant kits do not impact the vehicle's limited warranty.



STAGE III

SCREAMIN' EAGLE® 387

Twin Cam Stage III Upgrade

SCREAMIN' EAGLE® TWIN CAM STAGE III KIT – 103CI TO 110CI

Build a fast, reliable 110-cubic-inch Twin Cam hauler without having to remove the motor from the chassis. This Stage III Street Performance Kit combines system-matched Screamin' Eagle® big bore cylinders, high-compression pistons and performance cams and valve train components with the Original Equipment cylinder heads for a cost-effective boost in torque and performance. The exclusive bolt-on 4.0" cylinders are engineered with high-strength slim-wall spigots that slip into the factory crank case without any additional machining. The 4" flat top pistons team with the stock cylinder heads to produce a performance-enhancing 10.2:1 compression ratio (10.4:1 on Twin-Cooled™ equipped models), and the high-lift SE-585 cam produces a boost in torque throughout the RPM range. 50-State U.S. EPA compliant.

Kit includes:

- Screamin' Eagle 4.0" Bolt-On Cylinders
- Forged 10.2:1 Compression Pistons and Rings
- SE-585 Cams
- High Performance Valve Springs
- Perfect-Fit Pushrods
- Screamin' Eagle High-Capacity Roller Tappets
- Top End and Cam Cover Gaskets
- Heavy Duty Clutch Spring

92500035 **\$2,020.95**

Black Highlighted. Fits '16-'17 Softail® and '14-'16 Touring models. Does not fit Trike models, FLSS, FLSTFB, CVO™ 110 models or models with engine cases that have been machined to accept large-bore cylinders. Requires separate purchase of Cam Drive Retention Kit P/N 25566-06. Cam Spacer Kit P/N 25928-06 is recommended. Twin-Cooled models require separate purchase of model-specific head gaskets. All models require recalibration with Screamin' Eagle Pro Street Tuner (sold separately).

When installed by an authorized Harley-Davidson® Dealer within 60 days of the vehicle purchase, compliant kits do not impact the vehicle's limited warranty.



Twin Cam 103HO Stock vs. 103CI High Compression Kits with Cams & Street Cannon Mufflers

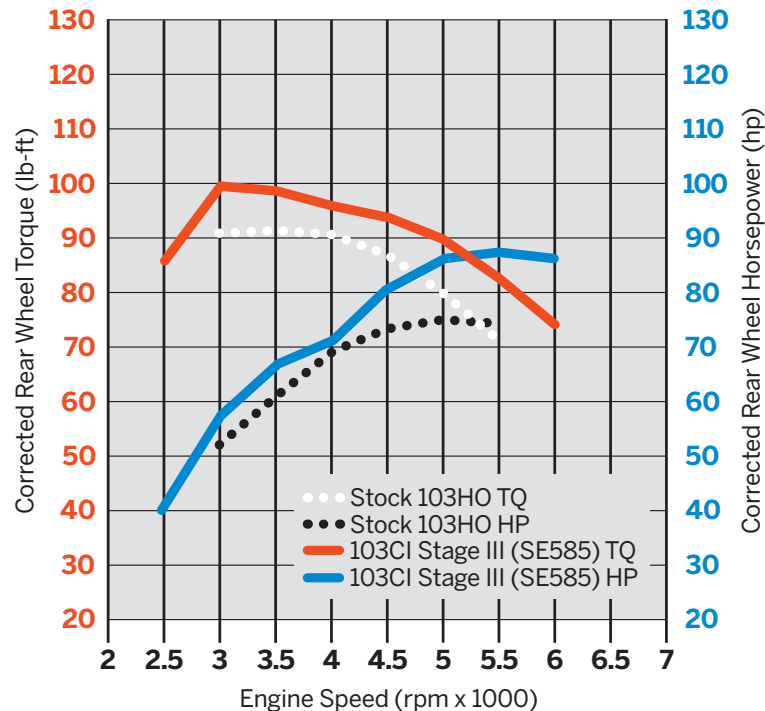

Street legal and/or street compliant statements refer to product meeting 50-State emissions and noise standards in the United States.

The street legal and/or street compliant statements may not apply to markets outside of the United States.

Notice: The prices appearing in this catalog are the manufacturer's suggested retail prices. Actual retail prices may vary.

Twin Cam 103HO Stock vs. 103 to 110CI Stage III with SE CVO Mufflers

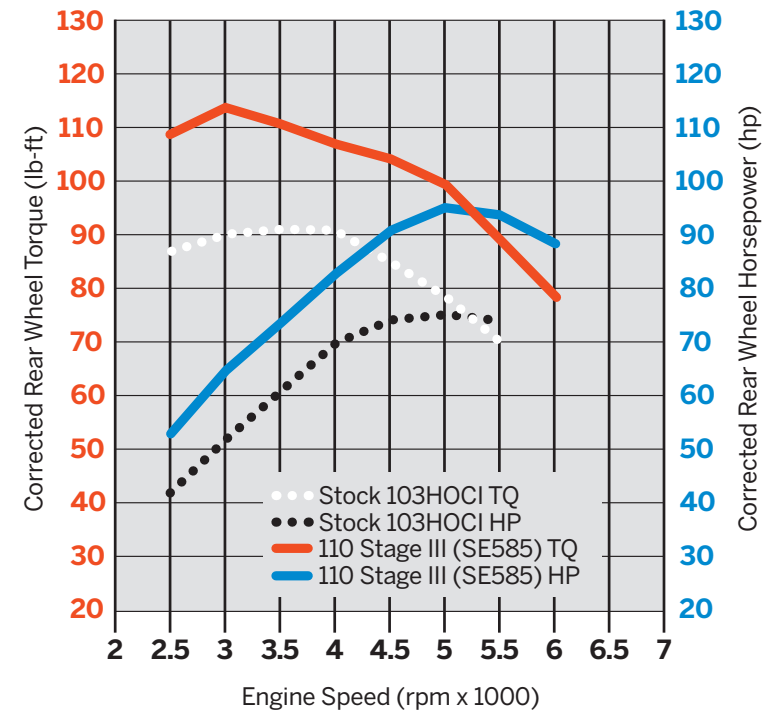

Street legal and/or street compliant statements refer to product meeting 50-State emissions and noise standards in the United States.

The street legal and/or street compliant statements may not apply to markets outside of the United States.

Notice: The prices appearing in this catalog are the manufacturer's suggested retail prices. Actual retail prices may vary.

388 SCREAMIN' EAGLE®

Twin Cam Stage III Upgrade

STAGE III



SCREAMIN' EAGLE® TWIN CAM CONVERSION KIT WITH CAMS – 96CI TO 103CI

The Stage II Big Bore Kit provides the parts you need to increase the horsepower of your EFI-equipped model. The kit increases the displacement of your Twin Cam-equipped model from 96 cubic inches (1584cc) to 103 cubic inches (1690cc). 50-State U.S. EPA compliant. California kits are street compliant on California pollution controlled vehicles when used with Original Equipment mufflers.

Kit includes:
 Big Bore Cylinders
 Big Bore Flat Top Pistons and Rings
 SE-255 Cams
 High-Flow Air Cleaner Kit with One-Piece Back Plate
 Top End Gasket Kit
 Heavy Duty Clutch Spring

27543-08 Black Highlighted. **\$1,080.95**

Fits '10-'11 Softail® models equipped with a Twin Cam 96™ engine. Also fits '08-'09 California Softail models. Installation requires separate purchase of Primary Cover Gasket, Cam Drive Retention Kit P/N 25566-06, Cam Spacer Kit P/N 25928-06 is recommended. All models require ECM calibration for proper installation.

27557-08 Black Highlighted. **\$1,080.95**

Fits '10-'11 Touring models equipped with Twin Cam 96 engine. Also fits '08-'09 California Touring models. '10 FLHX and FLTRX models require separate purchase of 2-into-2 Head Pipe and mufflers. Installation requires separate purchase of Primary Cover Gasket, Cam Drive Retention Kit P/N 25566-06, Cam Spacer Kit P/N 25928-06 is recommended. All models require ECM calibration for proper installation.

27564-09A Black Highlighted. **\$1,080.95**

Fits 49-state '09 Touring models. Kit includes catalyst head pipe. Does not fit Trike models. Not street compliant in California. Installation requires separate purchase of Primary Cover Gasket, Cam Drive Retention Kit P/N 25566-06, Cam Spacer Kit P/N 25928-06 is recommended. All models require ECM calibration for proper installation.

NOTICE: Installation of automatic or manual compression releases on large displacement engines is highly recommended.

NOTICE: Harley-Davidson will exclude H-D™ motorcycle limited warranty coverage and deny all motorcycle limited warranty claims for functional defects of powertrain components for any Harley-Davidson motorcycle registered in the United States if the vehicle was tuned using a tuning product not covered by a California Air and Resources Board Executive Order or that was otherwise approved by the Environmental Protection Agency, or if Harley-Davidson or any authorized Harley-Davidson dealer has any information to show that the vehicle was tuned using a tuning product not covered by a California Air and Resources Board Executive Order or that was otherwise approved by the Environmental Protection Agency. This includes Installation of a California performance kit onto a 49-state model motorcycle or a 49-state performance kit onto a California model motorcycle.

When installed by an authorized Harley-Davidson® Dealer within 60 days of the vehicle purchase, compliant kits do not impact the vehicle's limited warranty.

Street legal and/or street compliant statements refer to product meeting 50-State emissions and noise standards in the United States.

The street legal and/or street compliant statements may not apply to markets outside of the United States.

Notice: The prices appearing in this catalog are the manufacturer's suggested retail prices. Actual retail prices may vary.

Twin Cam 96 Stock vs. 96 to 103CI Conversion with Street Use Exhaust

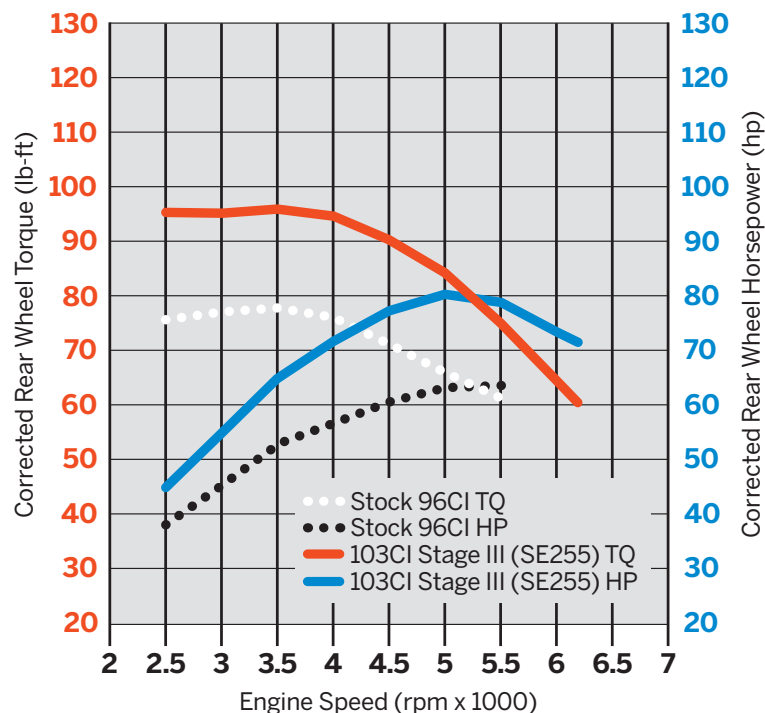

Street legal and/or street compliant statements refer to product meeting 50-State emissions and noise standards in the United States.

The street legal and/or street compliant statements may not apply to markets outside of the United States.

Notice: The prices appearing in this catalog are the manufacturer's suggested retail prices. Actual retail prices may vary.

STAGE III



SCREAMIN' EAGLE® 389

Twin Cam Stage III Upgrade

SCREAMIN' EAGLE® TWIN CAM CONVERSION KIT – 96CI TO 103CI

This Big Bore Kit lets you increase the displacement of your Twin Cam 96™ engine-equipped model from 96 cubic inches (1584cc) to 103 cubic inches (1690cc). A high-performance clutch spring is included to provide the additional clutch capacity required by the extra torque. 50-State U.S. EPA Compliant.

Kit includes:
 Big Bore Cylinders
 Big Bore Flat Top Pistons and Rings
 High-Flow Air Cleaner with One-Piece Back Plate
 Top End Gasket Kit
 Heavy Duty Clutch Spring

29903-07A Black Highlighted. **\$765.95**

Fits all '07 Twin Cam and '08-'11 Softail® models equipped with a Twin Cam 96™ engine. Installation requires separate purchase of Primary Cover Gasket, Cam Drive Retention Kit P/N 25566-06, Cam Spacer Kit P/N 25928-06 is recommended. All models require ECM calibration for proper installation.

27539-08A Black Highlighted (not shown). **\$765.95**

Fits '08-'11 Touring models equipped with a Twin Cam 96 engine. Installation requires separate purchase of Primary Cover Gasket, Cam Drive Retention Kit P/N 25566-06, Cam Spacer Kit P/N 25928-06 is recommended. All models require ECM calibration for proper installation.

NOTICE: Installation of automatic or manual compression releases on large displacement engines is highly recommended.

When installed by an authorized Harley-Davidson® Dealer within 60 days of the vehicle purchase, compliant kits do not impact the vehicle's limited warranty.

Twin Cam 96 Stock vs. 96 to 103CI Conversion

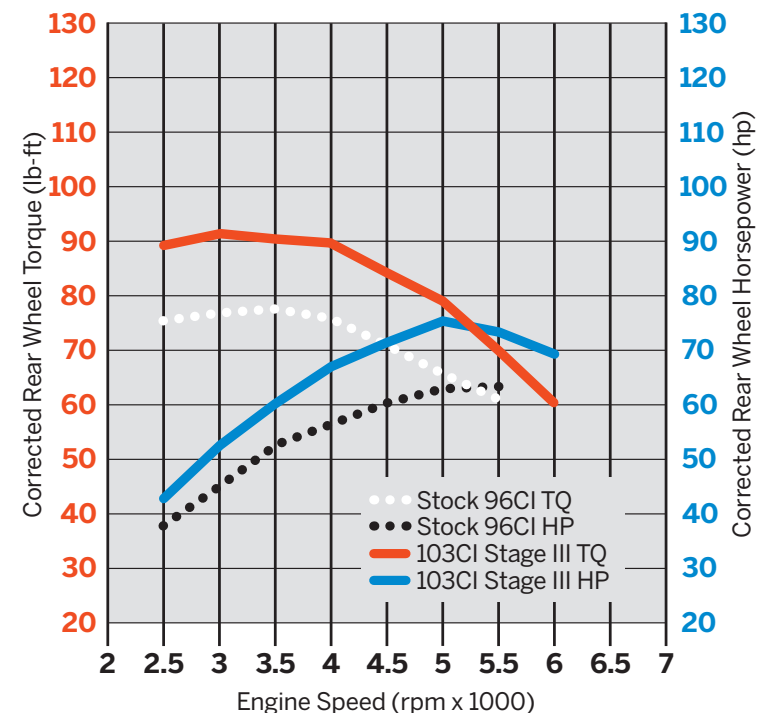

Street legal and/or street compliant statements refer to product meeting 50-State emissions and noise standards in the United States.

The street legal and/or street compliant statements may not apply to markets outside of the United States.

Notice: The prices appearing in this catalog are the manufacturer's suggested retail prices. Actual retail prices may vary.

SCREAMIN' EAGLE

390 SCREAMIN' EAGLE®

Twin Cam Stage IV Upgrade

STAGE IV

SCREAMIN' EAGLE® TWIN CAM TIRE SHREDDER KIT – 103CI TO 110CI

This comprehensive kit provides a complete package of matched components that allow you to build a high-performance 110CI Twin Cam without voiding the factory warranty. The unique Screamin' Eagle® 4.0" big bore cylinders are engineered to slip into the engine cases without case machining or modification, so the engine stays in the chassis during the build. 50-State U.S. EPA compliant.

Kit includes:

- Screamin' Eagle 4.0" Bolt-On Cylinders
- Forged 10.2:1 High Compression Pistons and Rings
- Screamin' Eagle 58mm Throttle Body
- High Flow Fuel Injectors (5.3 g/s)
- Screamin' Eagle CNC-Ported Cylinder Heads
- SE-259E Cams
- Perfect-Fit Pushrods
- Screamin' Eagle High-Capacity Roller Tappets
- Top End and Cam Cover Gaskets
- Heavy Duty Clutch Spring

92500038 **\$2,973.95**

Fits '14-'16 Touring models. Does not fit Twin-Cooled™ equipped models. Does not fit Trike models, CVO™ 110 models or models with engine cases that have been machined to accept large-bore cylinders. Requires separate purchase of accessory 58mm air cleaner and Cam Drive Retention Kit P/N 25566-06. Cam Spacer Kit P/N 25928-06 is recommended. All models require recalibration with Screamin' Eagle Pro Street Tuner (sold separately).

When installed by an authorized Harley-Davidson® Dealer within 60 days of the vehicle purchase, compliant kits do not impact the vehicle's limited warranty.



STAGE IV

SCREAMIN' EAGLE® 391

Twin Cam Stage IV Upgrade

SCREAMIN' EAGLE® TWIN CAM CONVERSION KIT – 103CI TO 110CI

Bring your Twin Cam motorcycle up to the same 110-cubic-inch displacement and power output as the CVO™ Screamin' Eagle® models without expensive machining or removing the engine from the chassis. This street compliant kit combines the proven SE-255 cams and cylinder heads of the CVO model with exclusive Screamin' Eagle bolt-on 4.0" cylinders and system-matched pistons to deliver high torque and reliable everyday performance. The automatic compression release-equipped cylinder heads and the flat top forged pistons combine to develop a 9.3:1 compression ratio for easy starting, and the Screamin' Eagle lifters ensure quiet reliable valve train operation. 50-State U.S. EPA compliant.

Kit includes:

- Screamin' Eagle 4.0" Bolt-On Cylinders
- Forged 9.3:1 Compression Pistons and Rings
- CVO 110 Cylinder Heads
- SE-255 Cams
- High-Capacity Roller Tappets
- Top End and Cam Cover Gaskets
- Heavy Duty Clutch Spring
- Cam Spacer Kit P/N 25928-06 is recommended

92500031 **\$2,512.95**

Black Highlighted. Fits '10-'16 Touring models (except '14-'16 models with Twin-Cooled™ engines). Does not fit Trike models, CVO 110 models, or models with engine cases that have been machined to accept large bore cylinders. Requires separate purchase of Screamin' Eagle high-flow air cleaner. '10 FLHX and FLTRX models require separate purchase of 2-into-2 Head Pipe Kit and Mufflers. '11-'16 Touring models require installation of CVO Mufflers P/N 64768-09A and 64769-09A or FatShotz Muffler Kit P/N 80847-10 (sold separately). '10-'11 Touring models require ACR Harness P/N 70623-08. Installation requires separate purchase of Primary Cover Gasket. Cam Drive Retention Kit P/N 25566-06. Cam Spacer Kit P/N 25928-06 is recommended. All models require ECM calibration for proper installation.

92500032 **\$2,617.95**

Black Highlighted. Fits '14-'16 FLHTCU, FLHTCUL, FLHTK, FLHTKL and FLTRU models with Twin-Cooled engines. Does not fit Trike models, CVO 110 models, or models with engine cases that have been machined to accept large bore cylinders. Requires separate purchase of Screamin' Eagle high-flow air cleaner. Installation requires separate purchase of Primary Cover Gasket. Cam Drive Retention Kit P/N 25566-06. Cam Spacer Kit P/N 25928-06 is recommended. All models require ECM calibration for proper installation.

92500033 **\$2,512.95**

Black Highlighted. Fits '11-'17 Dyna® FXD, FXDB and FXDC models equipped with Shorty Dual Exhaust. Installation requires separate purchase of Muffler P/N 64895-09 (Qty 2). Also fits 50-state '10-'17 FXDF and FXDWG models. FXDF and FXDWG models requires separate purchase of Mufflers P/N 65884-09 and 65886-09. All Dyna models require separate purchase of Screamin' Eagle high-flow cleaner. '10-'11 Dyna models require ACR Harness P/N 70623-06. Does not fit models with engine cases that have been machined to accept large-bore cylinders. Also fits 50-state '11-'17 Softail® models (except FLS, FLSS, FLSTFBS, FLSTN, FLSTS, CVO 110 models or models with engine cases that have been machined to accept large-bore cylinders.). Requires separate purchase of Screamin' Eagle high-flow air cleaner. '11 Softail models require ACR Harness P/N 70623-11. Installation requires separate purchase of Primary Cover Gasket. Cam Drive Retention Kit P/N 25566-06. Cam Spacer Kit P/N 25928-06 is recommended. All models require ECM calibration for proper installation. '17 models require recalibration with Screamin' Eagle Pro Street Tuner (sold separately).

When installed by an authorized Harley-Davidson® Dealer within 60 days of the vehicle purchase, compliant kits do not impact the vehicle's limited warranty.

Twin Cam 103HO Stock vs. 103 to 110CI Tire Shredder Kit with Heavy Breather & Street Cannon Mufflers

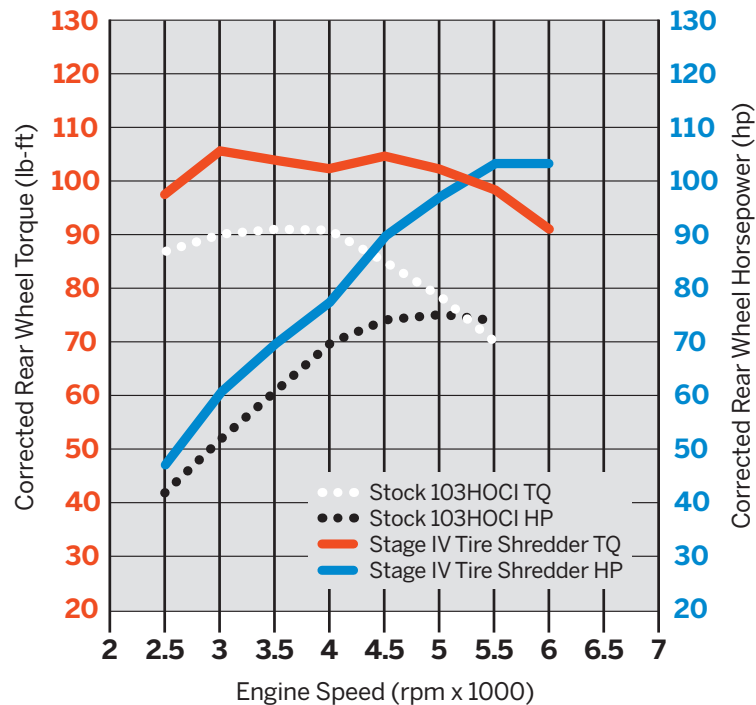

Street legal and/or street compliant statements refer to product meeting 50-State emissions and noise standards in the United States.

The street legal and/or street compliant statements may not apply to markets outside of the United States.

Notice: The prices appearing in this catalog are the manufacturer's suggested retail prices. Actual retail prices may vary.

Twin Cam 103HO Stock vs. 103 to 110CI Stage IV Conversion Kit

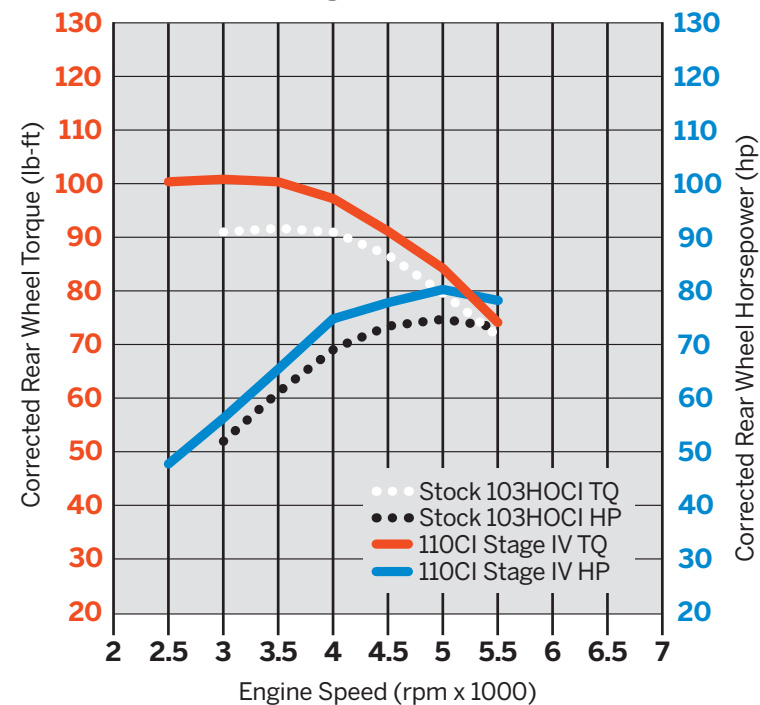

Street legal and/or street compliant statements refer to product meeting 50-State emissions and noise standards in the United States.

The street legal and/or street compliant statements may not apply to markets outside of the United States.

Notice: The prices appearing in this catalog are the manufacturer's suggested retail prices. Actual retail prices may vary.

392 SCREAMIN' EAGLE®

Twin Cam Stage IV Upgrade

STAGE IV

SCREAMIN' EAGLE® TWIN CAM STAGE IV KIT – 103CI TO 103CI

This Street Performance kit provides the maximum horsepower output for a legal 103 Kit that will maintain the factory warranty. The Air-Cooled Street Performance Kit produces 96 hp and 105 lbs-ft of torque. The Twin-Cooled™ engine version is rated at 93 hp and 100 lbs-ft of torque. 50-State U.S. EPA compliant.

Kit includes:

- Forged 10.5:1 High Compression Pistons and Rings
- Screamin' Eagle® 58mm Throttle Body
- Screamin' Eagle CNC Ported Cylinder Heads
- SE-259E Cams
- Perfect-Fit Pushrods
- Top End Gasket Kit
- Heavy Duty Clutch Spring

92500011 Black Highlighted. **\$2,265.95**

Fits '16-'17 Softail® (except FLSS, FLSTFBS and FXSE) and '10-'16 Touring models (except '14-'16 models with Twin-Cooled engines) equipped with a Twin Cam 103™ engine. Fits 49-state '10-'11 Touring models equipped with a Twin Cam 96™ engine with separate purchase of Screamin' Eagle 3-7/8" Big Bore Cylinder Kit. '10 FLHX and FLTRX requires dual exhaust. Does not fit Trike models. Installation requires separate purchase of Primary Cover Gasket. Cam Drive Retention Kit P/N 25566-06. Cam Spacer Kit P/N 25928-06 is recommended. All models require ECM calibration for proper installation. '17 models require recalibration with Screamin' Eagle Pro Street Tuner (sold separately).



6

When installed by an authorized Harley-Davidson® Dealer within 60 days of the vehicle purchase, compliant kits do not impact the vehicle's limited warranty.

STAGE IV

SCREAMIN' EAGLE® 393

Twin Cam Stage IV Upgrade

SCREAMIN' EAGLE® TWIN CAM BOLT-ON 110CI TO 117CI KIT

Turn your Original Equipment 110-cubic-inch model into a fast, reliable 117-cubic-inch Twin Cam hauler without having to remove the motor from the chassis. This Street Performance Kit combines system-matched Screamin' Eagle® big bore cylinders, forged pistons and performance cams and valve train components with the Original Equipment cylinder heads for a cost-effective boost in torque and performance. The exclusive bolt-on 4.125" cylinders are engineered with high-strength slim-wall spigots that slip into the factory 110CI crank case without any additional machining. The 4.125" flat top pistons team with the stock cylinder heads to produce a performance-enhancing 9.9:1 compression ratio, and the high-lift SE-259E cam produces a boost in torque throughout the RPM range. 50-State U.S. EPA compliant.

Kit includes:

- Screamin' Eagle 4.125" Bolt-On Cylinders
- Forged 9.9:1 Compression Pistons and Rings
- Screamin' Eagle 58mm Throttle Body
- High Flow Fuel Injectors (5.3 g/s)
- SE-259E Cams
- Perfect-Fit Pushrods
- Screamin' Eagle High-Capacity Roller Tappets
- Screamin' Eagle Inner Cam Bearing Kit
- Top End and Cam Cover Gaskets

Fits '14-'17 CVO™ 110CI Softail® and '14-'16 CVO Touring models. Also fits '16-'17 110CI FLSS, FLSTFBS and FXDLS models. Requires purchase of accessory 58mm air cleaner and Cam Drive Retention Kit P/N 25566-06 (except models equipped with Screamin' Eagle Heavy Breather Elite Performance Air Cleaner Kits). Models equipped with Ventilator Air Cleaner require separate purchase of 58mm Air Cleaner Backplate P/N 29400038. All models require ECM calibration for proper installation. '16-'17 FXDLS and all '17 models require recalibration with Screamin' Eagle Pro Street Tuner (sold separately).

92500055 Granite Finish. **\$2,290.95**

92500054 Black Finish. **\$2,290.95**



6

When installed by an authorized Harley-Davidson® Dealer within 60 days of the vehicle purchase, compliant kits do not impact the vehicle's limited warranty.

Air-Cooled
Twin Cam 103HO Stock vs. 103CI Stage IV with Heavy Breather & Street Cannon Mufflers

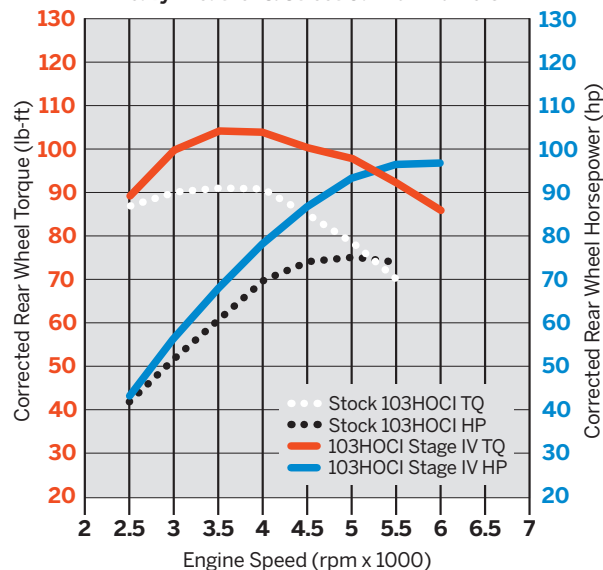

Twin-Cooled™
Twin Cam 103HO Stock vs. 103CI Stage IV with Heavy Breather & Street Cannon Mufflers

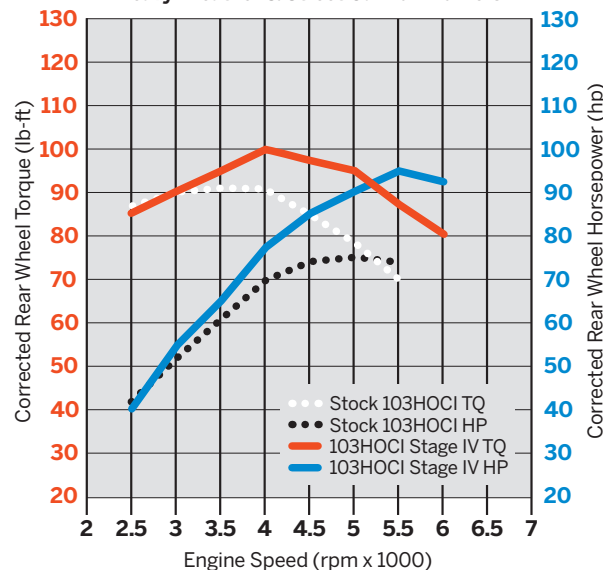

Twin Cam CVO™ 110CI Stock vs. 110 to 117CI Stage IV with Ventilator Air Cleaner & SE CVO Mufflers

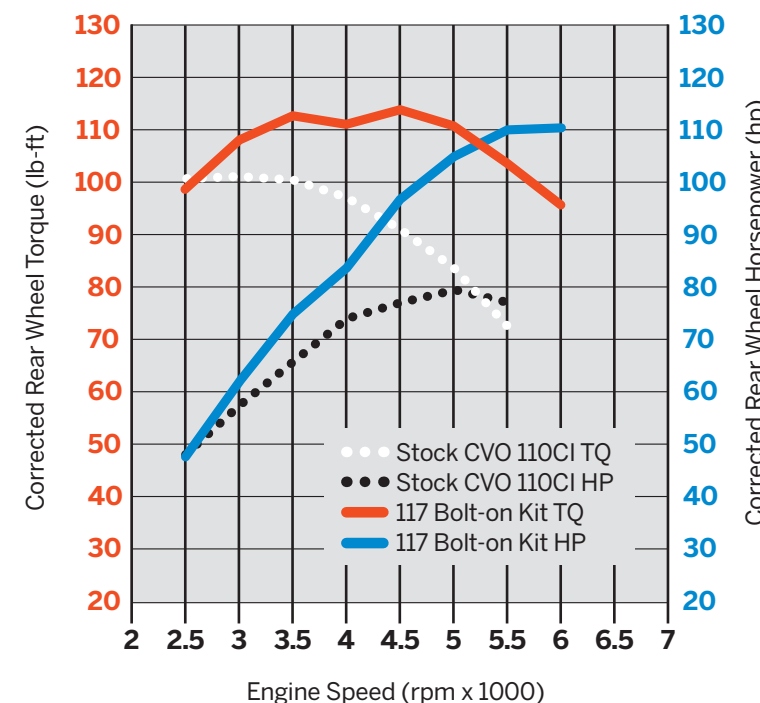

Street legal and/or street compliant statements refer to product meeting 50-State emissions and noise standards in the United States.

The street legal and/or street compliant statements may not apply to markets outside of the United States.

Notice: The prices appearing in this catalog are the manufacturer's suggested retail prices. Actual retail prices may vary.

Street legal and/or street compliant statements refer to product meeting 50-State emissions and noise standards in the United States.

The street legal and/or street compliant statements may not apply to markets outside of the United States.

Notice: The prices appearing in this catalog are the manufacturer's suggested retail prices. Actual retail prices may vary.

SCREAMIN' EAGLE

SPORTSTER® POWERTRAIN

Screamin' Eagle® Stage upgrades offer complete street-compliant performance configurations engineered to generate specific torque and horsepower gains. Eliminating all the guesswork and trial-and-error testing normally associated with engine modifications, Stage upgrades include everything you need to enhance your bike's performance.

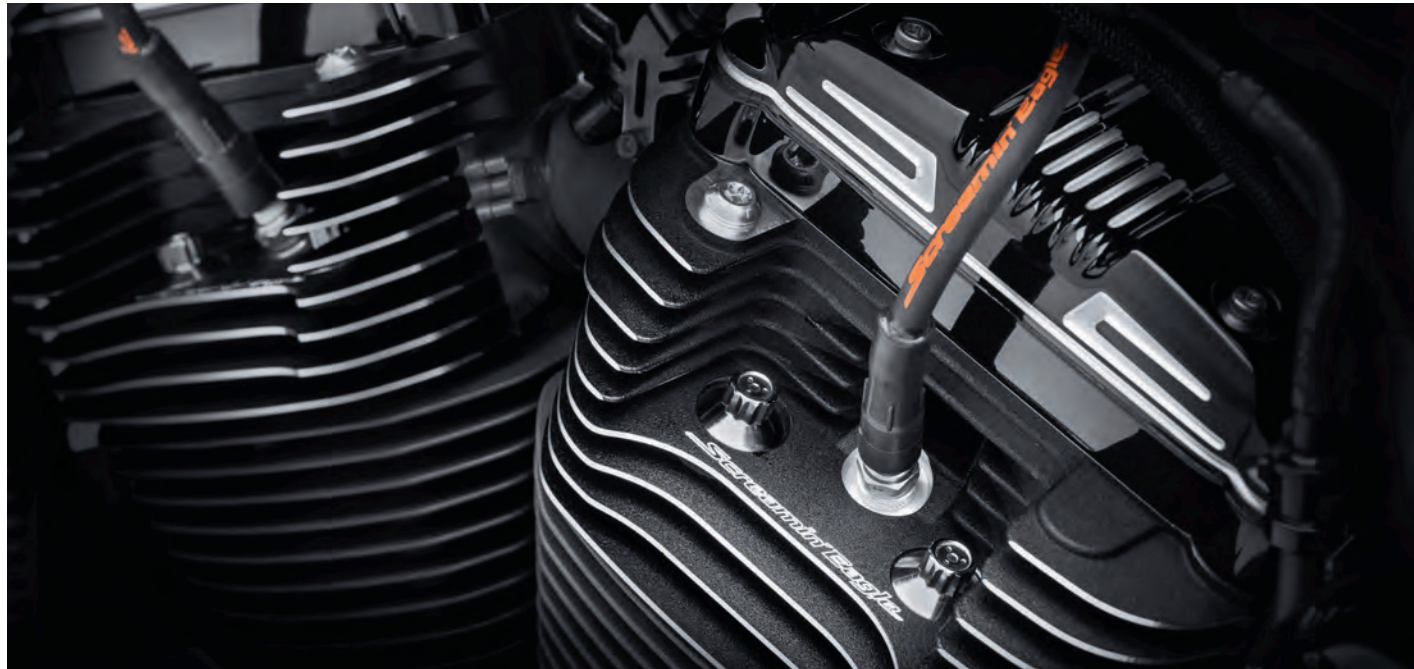

STAGE I

INTAKE + EXHAUST + TUNING

The easiest and most cost-effective step to improve your motorcycle's performance is to increase the airflow into and out of the engine. A high-flow air cleaner and system-matched slip-on mufflers provide horsepower and torque improvements you can feel throughout the RPM range, and serve as the core components for all performance upgrades. ECM calibration is required to tune the fuel flow and timing required to accommodate the improved airflow.

Stage I upgrade can be installed without engine disassembly. No special tools are required. Requires ECM tuning.



Street legal and/or street compliant statements refer to product meeting 50-State emissions and noise standards in the United States. The street legal and/or street compliant statements may not apply to markets outside of the United States.

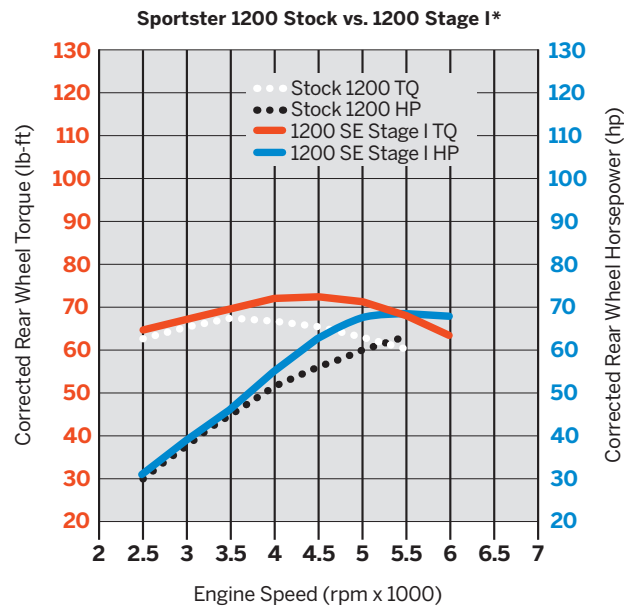

* 14-'22 XL1200 Stage II with Heavy Breather A/C & Street Cannon Mufflers

STAGE II

STAGE I + CAM UPGRADE

Adding performance cams to a Stage I equipped bike is the next step to improved performance. Cam choices allow you to tailor the engine's performance to your specific needs. A torque cam offers on-demand throttle response from low to mid RPM at cruising speed. A power cam targets high-RPM, wide-open throttle response that keeps pulling right up to redline. ECM calibration tuning is required to accommodate the increased valve timing, and performance valve springs may be required for high-lift cams.

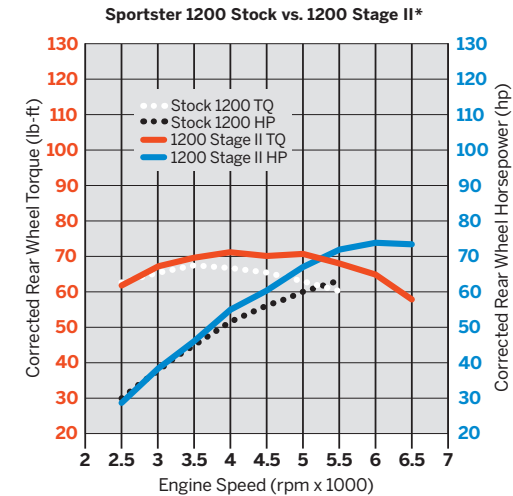

* 14-'22 XL1200 Stage II with Heavy Breather A/C & Street Cannon Mufflers



Stage II upgrade requires minor engine disassembly to replace the cam. Special tools and ECM tuning are required.



STAGE IV

STAGE I + CAMS, PISTONS, CYLINDER HEADS & THROTTLE BODY

For maximum performance improvement, the addition of high-compression pistons, free-flowing ported cylinder heads and a big bore throttle body top off a performance build. The large-diameter throttle body and port-matched intake manifold deliver huge volumes of fuel and air to the engine, the smooth passages and larger valves easily dump the mixture into the engine and the high compression pistons squeeze the air/fuel into a more volatile vapor. When ignited, the result is a major power increase. Designed to satisfy the high-RPM, throttle-twisting rider, the Stage IV update delivers 20-30% increase in power that keeps pulling right up to the redline, without sacrificing mid-range torque. ECM calibration tuning is required to add more fuel, and a higher-lift cam may be required to deliver maximum power.

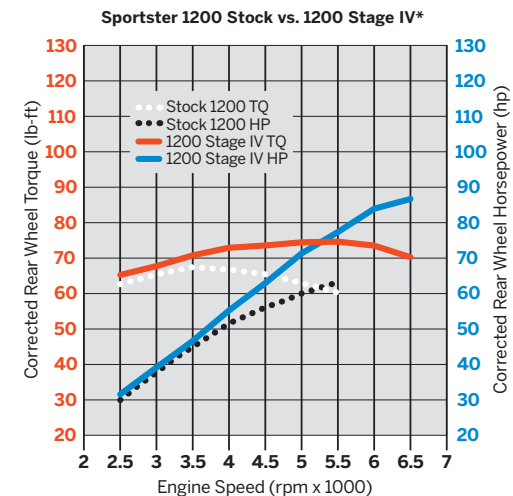

* 1200 Stage IV with High-Flow A/C & Street Cannon Mufflers



Stage IV bolt-on upgrade requires removal of the engine's top end and opening the cam chest. Engine remains in the chassis and no machining is required. Special tools and ECM tuning are required.



Street legal and/or street compliant statements refer to product meeting 50-State emissions and noise standards in the United States. The street legal and/or street compliant statements may not apply to markets outside of the United States.

396 SCREAMIN' EAGLE®

Sportster® Stage I Upgrade

A. SCREAMIN' EAGLE® HEAVY BREATHER PERFORMANCE AIR CLEANER KIT

This high-flow forward-facing exposed element Air Cleaner Kit is sure to turn heads at the starting line. Featuring a polished elbow and exposed filter, this unique air cleaner system offers improved performance and airflow when compared to the stock or Screamin' Eagle® High-Flow Air Cleaner. The washable and rechargeable filter features a bright chrome end cap with a laser-engraved Screamin' Eagle logo. Intake tube and back plate are made from die-cast lightweight aluminum and are polished and chrome-plated or painted black for a brilliant finish. The back plate features integral breathers and sealed breather bolt plug. Kit includes a water-repellent rain sock and all mounting hardware. 50-State U.S. EPA compliant.

Fits '08-'22 XL models with Original Equipment Throttle Body. All models require ECM calibration for proper installation. '17-later models require recalibration with Screamin' Eagle Pro Street Tuner (sold separately). Pending approval for use in California on '21 models. Refer to H-D.com/shop for status.

29080-09A Gloss Black. **\$378.95**

Fits '14-'22 XL1200 model equipped with Screamin' Eagle High Flow 58mm Throttle Body. All models require ECM calibration for proper installation. '17-later models require recalibration with Screamin' Eagle Pro Street Tuner (sold separately).

29400228A Chrome. **\$399.95**

29400227A Gloss Black. **\$399.95**

NOTE: The washable and rechargeable filter uses a special coating to help filter fine particles from the incoming air. With time, the oil in the filter will dissipate and the element will begin to turn gray. The original red color can be restored with an application of K&N® Air Filter Oil.

B. SCREAMIN' EAGLE HEAVY BREATHER FILTER COVER – TEARDROP

Dress up the Heavy Breather Air Cleaner with this radical cover. Manufactured from forged aluminum and precision CNC-machined and polished, these easy-to-install two-piece covers add a rich custom look. Cover is available in mirror-chrome or cut back gloss black finish to match your customizing direction. Kit includes water-repellent rain sock.

Fits models equipped with Screamin' Eagle Heavy Breather Air Cleaner Kits on Twin Cam and XL model. (except Compact Heavy Breather P/N 28716-10A, Heavy Breather Elite P/N 29400173, 29400172 or 29400285, and Milwaukee Eight® Heavy Breather P/N 29400263 or 29400264).

29400061A Cut Back Gloss Black – Side Logo. **\$185.95**

28739-10A Cut Back Gloss Black – End Logo. **\$185.95**

28740-10A Chrome – End Logo. **\$185.95**

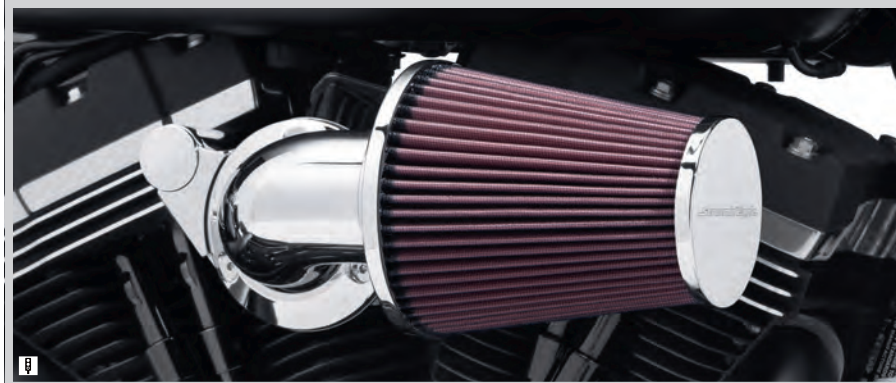

A. SCREAMIN' EAGLE HEAVY BREATHER PERFORMANCE AIR CLEANER KIT – CHROME

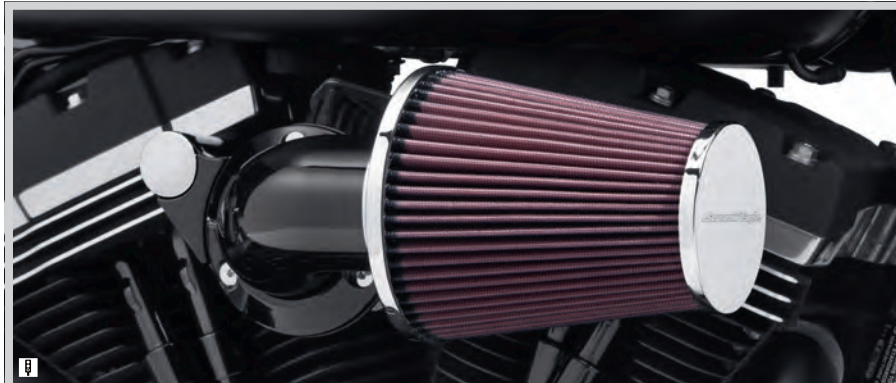

A. SCREAMIN' EAGLE HEAVY BREATHER PERFORMANCE AIR CLEANER KIT – GLOSS BLACK



B. SCREAMIN' EAGLE HEAVY BREATHER FILTER COVER – TEARDROP, CUT BACK GLOSS BLACK – SIDE LOGO



B. SCREAMIN' EAGLE HEAVY BREATHER FILTER COVER – TEARDROP, CHROME



B. SCREAMIN' EAGLE HEAVY BREATHER FILTER COVER – TEARDROP, CUT BACK GLOSS BLACK



C. SCREAMIN' EAGLE PERFORMANCE AIR CLEANER KIT – RAIL COLLECTION



D. EXTREME BILLET AIR CLEANER KIT – CHISEL, CHROME



D. EXTREME BILLET AIR CLEANER KIT – CHISEL, CUT BACK GLOSS BLACK

SCREAMIN' EAGLE® 397

Sportster® Stage I Upgrade

C. SCREAMIN' EAGLE® PERFORMANCE AIR CLEANER KIT – RAIL COLLECTION

The look is bold and the performance exhilarating. This race-inspired air cleaner is engineered to flow through the perimeter and the face of the air filter, providing high volumes of unrestricted airflow to the engine. The open-design face plate features a rich black finish with machined longitudinal strakes to expose the glowing aluminum below. Kit includes air cleaner trim, one-piece cast back plate, high-flow washable air filter element, rain sock and all required hardware. 50-State U.S. EPA compliant.

29400232A **\$347.95**

Fits '07-'22 XL models with Original Equipment throttle body. All models require ECM calibration for proper installation. '17-later models require recalibration with Screamin' Eagle® Pro Street Tuner (sold separately). Pending approval for use in California on '21 models. Refer to H-D.com/shop for status.

D. SCREAMIN' EAGLE EXTREME BILLET AIR CLEANER KIT

The bold styling of this intake system looks just as impressive as the long patch or burnout rubber you just laid down. The forged billet aluminum cover tops off a cast back plate with integral breather for a smooth transition to the throttle body. The race-inspired air cleaner is engineered to flow high volumes of air and the washable pleated element provides the ideal combination of efficiency and engine protection. Available in your choice of style and finish, this easy-to-install kit includes all mounting hardware and rain sock. 50-State U.S. EPA compliant.

Fits '07-'22 XL models with Original Equipment throttle body. All models require ECM calibration for proper installation. '17-later models require recalibration with Screamin' Eagle Pro Street Tuner (sold separately). Pending approval for use in California on '21 models. Refer to H-D.com/shop for status.

29400128 Chisel – Chrome. **\$399.95**

29400127 Chisel – Cut Back Gloss Black. **\$399.95**

NOTE: The washable and rechargeable filter uses a special coating to help filter fine particles from the incoming air. With time, the oil in the filter will dissipate and the element will begin to turn gray. The original red color can be restored with an application of K&N® Air Filter Oil.

Street legal and/or street compliant statements refer to product meeting 50-State emissions and noise standards in the United States.

The street legal and/or street compliant statements may not apply to markets outside of the United States.

Notice: The prices appearing in this catalog are the manufacturer's suggested retail prices. Actual retail prices may vary.

Street legal and/or street compliant statements refer to product meeting 50-State emissions and noise standards in the United States.

The street legal and/or street compliant statements may not apply to markets outside of the United States.

Notice: The prices appearing in this catalog are the manufacturer's suggested retail prices. Actual retail prices may vary.

398 SCREAMIN' EAGLE®

Sportster® Stage I Upgrade

A. SCREAMIN' EAGLE® OVAL HIGH-FLOW AIR CLEANER

The XL High-Flow Air Cleaner Kit provides increased airflow to boost the power of your fuel-injected Sportster® model. The complete kit features a composite air cleaner back plate, air cleaner cover adapter, a high-flow washable synthetic media filter element that does not require oiling and a breather system that routes gasses and excess oil directly into the intake. Kit also includes cover trim and all mounting hardware. Street compliant when used with stock mufflers. 50-State U.S. EPA compliant.

29782-07 **\$165.95**

Fits '07-'22 XL models with Original Equipment throttle body and oval air cleaner cover. All models require ECM calibration for proper installation. '17-later models require recalibration with Screamin' Eagle® Pro Street Tuner (sold separately). Pending approval for use in California on '21 models. Refer to H-D.com/shop for status.

B. SCREAMIN' EAGLE ROUND HIGH-FLOW AIR CLEANER

The XL High-Flow Air Cleaner Kit provides increased airflow to boost the power of your fuel-injected Sportster model. Available with brilliant chrome or gloss black back plate, this Round Air Cleaner transforms the appearance of your Evolution powerplant and allows you to replace the Original Equipment oval air cleaner cover with your choice of accessory round covers. Or choose to flaunt your performance gains with the open element look, finished with custom Air Cleaner Trim from one of the Harley-Davidson® decorative collections. Kit includes one-piece cast back plate, high-flow washable air filter element and all required hardware. Street compliant when used with stock mufflers. 50-State U.S. EPA compliant.

Fits '07-'22 XL models with Original Equipment throttle body and round air cleaner cover or round air cleaner Trim. Proper installation with round air cleaner cover requires separate purchase of Air Cleaner Filter Gasket P/N 25700127. All models require ECM calibration for proper installation. '17-later models require recalibration with Screamin' Eagle Pro Street Tuner (sold separately). Pending approval for use in California on '21 models. Refer to H-D.com/shop for status.

29000019A Chrome. **\$160.95**
29000009A Black. **\$160.95**

C. SCREAMIN' EAGLE AIR CLEANER RAIN SOCK

Add the open-element look to your Screamin' Eagle High-Flow style Air Cleaner. This easy-to-install kit allows you to replace the traditional Original Equipment air cleaner cover with custom inserts from one of the H-D® Decorative Collections. Kit includes a breathable mesh cover with classic Bar & Shield logo that stretches over the filter to maximize airflow while protecting the exposed element from the rain. Fits traditional cone-shaped air cleaner elements featured in many Screamin' Eagle Twin Cam Stage Kits.

28728-10 **\$29.95**
Fits Screamin' Eagle Round High-Flow Air Cleaner Kits.



A. SCREAMIN' EAGLE OVAL HIGH-FLOW AIR CLEANER



B. SCREAMIN' EAGLE ROUND HIGH-FLOW AIR CLEANER



C. SCREAMIN' EAGLE AIR CLEANER RAIN SOCK (SHOWN WITH #1 SKULL AIR CLEANER TRIM)



D. SCREAMIN' EAGLE STREET CANNON SLIP-ON MUFFLERS – SPORTSTER SHORTY DUAL, CHROME (SHOWN WITH CHROME SLASH END CAPS AND BUCKSHOT EXHAUST SHIELDS)



D. SCREAMIN' EAGLE STREET CANNON SLIP-ON MUFFLERS – SPORTSTER SHORTY DUAL, JET BLACK (SHOWN WITH JET BLACK SLASH END CAPS AND BUCKSHOT EXHAUST SHIELDS)



E. SCREAMIN' EAGLE STREET PERFORMANCE SLIP-ON SHORTY DUAL MUFFLERS – CHROME



E. SCREAMIN' EAGLE STREET PERFORMANCE SLIP-ON SHORTY DUAL MUFFLERS – JET BLACK (SHOWN WITH JET BLACK BUCKSHOT EXHAUST SHIELDS)

SCREAMIN' EAGLE® 399

Sportster® Stage I Upgrade

D. SCREAMIN' EAGLE® STREET CANNON SLIP-ON MUFFLERS – SPORTSTER® SHORTY DUAL

These 3.25" street compliant high-flow mufflers have been specifically tuned to deliver an aggressive exhaust note and improved performance while preserving the peace with your neighbors. Available in your choice of rich chrome or heat-resistant jet black ceramic finish. Complete the look with your choice of 3.25" endcaps and Screamin' Eagle® Muffler shields (sold separately).

Fits '14-'22 XL models. Installation requires separate purchase of 3.25" End Caps and Muffler Clamps P/N 65900012 (Qty 2). All models require ECM calibration for proper installation. '17-later models require recalibration with Screamin' Eagle® Pro Street Tuner (sold separately). Pending approval for use in California on '21 models. Refer to H-D.com/shop for status.

64900208A Chrome. **\$493.95**
64900209A Jet Black. **\$537.95**

Fits '17-'20 XL1200 models. Designed for International markets that require ECM certified mufflers. Mufflers include matching slash down end caps. Installation requires separate purchase of Muffler Clamps P/N 65900012 (Qty 2).

64900477 Chrome. **\$1,024.95**
64900476 Jet Black. **\$1,150.95**

E. SCREAMIN' EAGLE STREET PERFORMANCE SLIP-ON MUFFLERS – SPORTSTER SHORTY DUAL

Street compliant high-flow mufflers are factory tuned to deliver an aggressive exhaust note and improved performance comparable to Screamin' Eagle II mufflers. Available in your choice of rich chrome or heat-resistant jet black ceramic finish, these mufflers feature a deep embossed Screamin' Eagle logo along the flank. 50-State U.S. EPA compliant.

Fits '07-'13 XL models. Installation requires separate purchase of Muffler Clamps P/N 65296-95A (Qty 2).

80503-07 Chrome. **\$319.95**
80726-09A Jet Black. **\$425.95**

Street legal and/or street compliant statements refer to product meeting 50-State emissions and noise standards in the United States.

The street legal and/or street compliant statements may not apply to markets outside of the United States.

Notice: The prices appearing in this catalog are the manufacturer's suggested retail prices. Actual retail prices may vary.

Street legal and/or street compliant statements refer to product meeting 50-State emissions and noise standards in the United States.

The street legal and/or street compliant statements may not apply to markets outside of the United States.

Notice: The prices appearing in this catalog are the manufacturer's suggested retail prices. Actual retail prices may vary.

400 SCREAMIN' EAGLE®

Sportster® Stage I Upgrade

A. MUFFLER END CAPS – 3.25"

These easy-to-install caps allow you to finish your 3.25" Screamin' Eagle® mufflers your way. Sold in pairs. Installation hardware included.

Fits '14-'22 XL and '07-'17 Softail® models equipped with Screamin' Eagle 3.25" Street Cannon Mufflers.

65100048A	Satin Black Anodized.	\$119.95
65100044	Chrome – Slash Up/Down/Out.	\$107.95
65100063	Jet Black – Slash Up/Down/Out.	\$118.95

B. JET BLACK HEADER PIPES

Hide the blue. These Original Equipment-style Header Pipes have been finished with a unique jet black heat-resistant coating and are a great accent to both chrome and black Buckshot exhaust shields. When exposed through the holes in the Buckshot shields, the black header pipe provides a sinister accent and hides the heat-tempered finish of the typical exhaust pipe. Easy to install using factory mounting hardware, the kit includes front and rear header pipe.

65600155 Jet Black. **\$263.95**
Fits '14-'22 XL models. Does not fit international models.

C. SCREAMIN' EAGLE® SLASH-CUT MUFFLER SHIELDS – SATIN BLACK

Shaped to mirror the slash down profile of available muffler end caps, this set of rich satin black Muffler Shields is the perfect complement to your blacked-out exhaust system. The rear shield features a subtle laser-etched Screamin' Eagle script. Easy-to-install kit includes front and rear shields and black mounting hardware.

65400405 Satin Black. **\$139.95**
Fits '07-'22 XL, '07-'17 Dyna® (except '08-'17 FLD, FXDF, FXDL, FXDLS and '10-'17 FXDWG) and '07-'17 Softail models equipped with Screamin' Eagle Street Performance mufflers.

D. SCREAMIN' EAGLE SLASH-CUT MUFFLER SHIELDS – CHROME

Styled to complement the ballistic inlet shape of the Screamin' Eagle Street Performance Slip-On Mufflers. The slash-cut rear shield features a laser-etched Screamin' Eagle signature script. Easy-to-install kit includes front and rear shields and mounting hardware.

65400464 Chrome. **\$83.95**
Fits '07-'22 XL, '07-'17 Dyna® (except '08-'17 FLD, FXDF, FXDL, FXDLS and '10-'17 FXDWG) and '07-'17 Softail models equipped with Screamin' Eagle Street Performance Mufflers.



A. MUFFLER END CAPS – 3.25"
(SATIN BLACK ANODIZED SHOWN)



A. MUFFLER END CAPS – 3.25"



B. JET BLACK HEADER PIPES



C. SCREAMIN' EAGLE SLASH-CUT MUFFLER SHIELDS – SATIN BLACK



D. SCREAMIN' EAGLE SLASH-CUT MUFFLER SHIELDS – CHROME

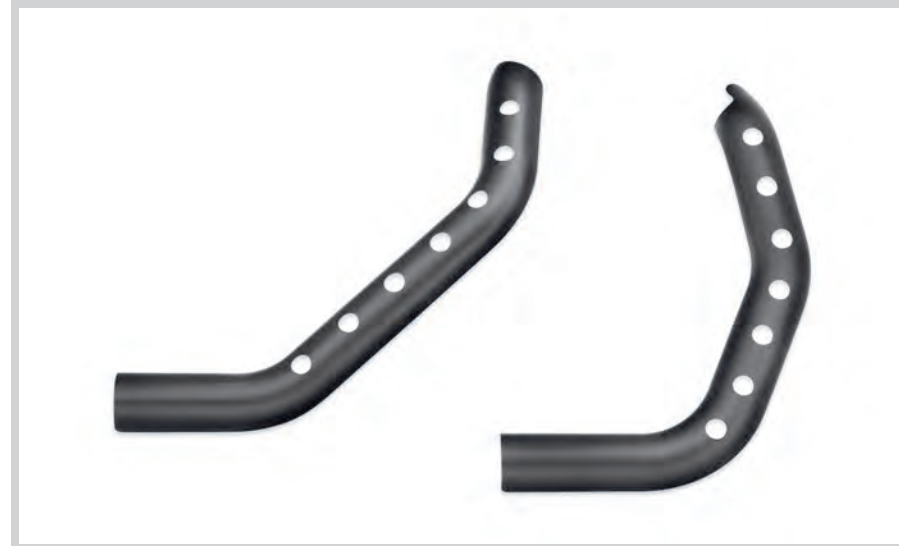

E. BUCKSHOT EXHAUST SHIELD KIT – JET BLACK (65400137A SHOWN)

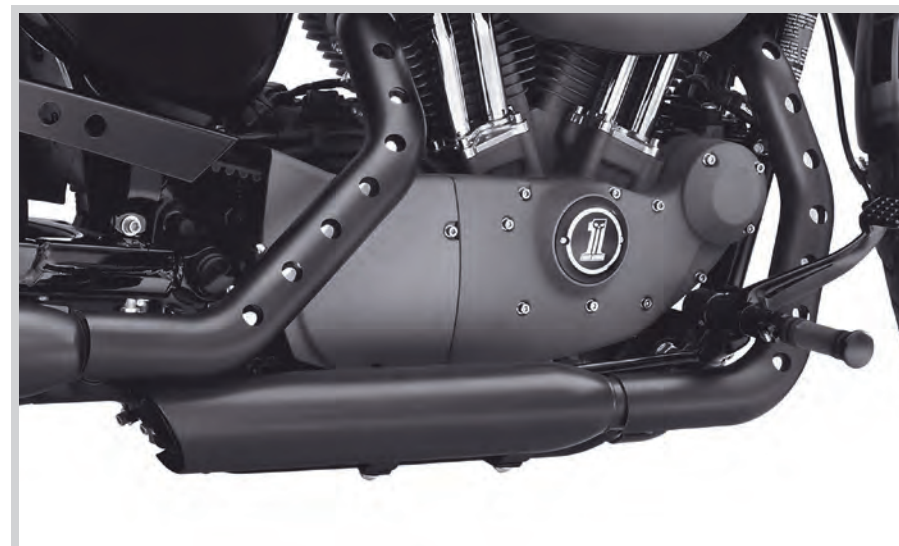

F. BUCKSHOT EXHAUST SHIELD KIT – JET BLACK



F. SCREAMIN' EAGLE MUFFLER SHIELDS

SCREAMIN' EAGLE® 401

Sportster® Stage I Upgrade

E. BUCKSHOT EXHAUST SHIELD KIT

These custom shields feature a perforated "Buckshot" design that exposes the head pipe for a raw, rebellious look. Available in your choice of finishes, these exhaust shields are a perfect match for Original Equipment or Screamin' Eagle® mufflers and provide a consistent look from front to back. Manufactured to Original Equipment standards for exacting fit, the easy-to-install kit includes front and rear head pipe shields.

65400137A Jet Black. **\$170.95**
Fits '14-'22 XL models.

F. SCREAMIN' EAGLE® MUFFLER SHIELDS

Styled to complement the ballistic inlet shape of the Screamin' Eagle Street Performance Slip-On Mufflers. The rear shield features a deep embossed Screamin' Eagle signature script. Available in chrome and jet black. Easy-to-install kit includes front and rear shields and mounting hardware.

65400078 Jet Black. **\$139.95**
Fits '07-'22 XL, '07-'17 Dyna® (except '08-'17 FLD, FXDF, FXDL and '10-later FXDWG) and '07-'17 Softail® models equipped with Screamin' Eagle Street Performance Mufflers.

Street legal and/or street compliant statements refer to product meeting 50-State emissions and noise standards in the United States.

The street legal and/or street compliant statements may not apply to markets outside of the United States.

Notice: The prices appearing in this catalog are the manufacturer's suggested retail prices. Actual retail prices may vary.

Street legal and/or street compliant statements refer to product meeting 50-State emissions and noise standards in the United States.

The street legal and/or street compliant statements may not apply to markets outside of the United States.

Notice: The prices appearing in this catalog are the manufacturer's suggested retail prices. Actual retail prices may vary.

402 SCREAMIN' EAGLE®

Sportster® Stage II Upgrade

A. SCREAMIN' EAGLE® PERFORMANCE II SE-585 CAM KIT- SPORTSTER®

The high-lift full throttle cam kit provides significant horsepower gains when coupled with high-flowing exhaust and intake components, and is a great fit for full-throttle horsepower junkies. 50-State U.S. EPA compliant. (exception below).

25400125 **\$393.95**

Fits '14-'22 XL1200 models. Requires installation of Performance Cylinder Heads P/N 16500074 or 16500347, or upgrade of Original Equipment heads with Performance Valve Spring Kit P/N 18013-03A. All EFI models require ECM calibration for proper installation. '17-later models require recalibration with Screamin' Eagle® Pro Street Tuner (sold separately). Labor cost not included. See Dealer for details. Does not fit '22 California models.

B. SCREAMIN' EAGLE HIGH-CAPACITY TAPPETS

Screamin' Eagle Tappets feature large high-capacity needles in the roller bearing assembly to improve reliability when operating with high-lift cams, high-pressure valve springs and in high-RPM applications. The 25% larger needle bearings increase the dynamic load rating by approximately 20% when compared to the Original Equipment Twin Cam tappets. The unique design delivers superior tappet life in performance applications. Set of 4.

18572-13 **\$274.95**

Fits '17-later Milwaukee-Eight® Engine equipped models, '00-'22 XL and XR models and '99-'17 Twin Cam-equipped models.

C. SCREAMIN' EAGLE PERFORMANCE VALVE SPRING KIT

This performance beehive-shaped Valve Spring Kit will permit the Sportster® engine to rev to 7000 RPM. The unique ovate wire yields increased performance from a compact spring design. The installed spring pressure is increased to 208 lbs and allows a maximum lift of .590". Complete kit includes springs, upper collars and keepers and lower collars with integral valve seals.

18013-03A **\$175.95**

Fits '04-'22 XL, XR and '05-'17 Twin Cam-equipped models. Does not fit FXDLS, FLSS, FLSTFBS or Screamin' Eagle Performance Heads with .3125" diameter valves.

STAGE II



A. SCREAMIN' EAGLE PERFORMANCE II SE-585 CAM KIT- SPORTSTER



B. SCREAMIN' EAGLE HIGH-CAPACITY TAPPETS



C. SCREAMIN' EAGLE PERFORMANCE VALVE SPRING KIT

Sportster 1200 Stock vs. 1200 Stage II*

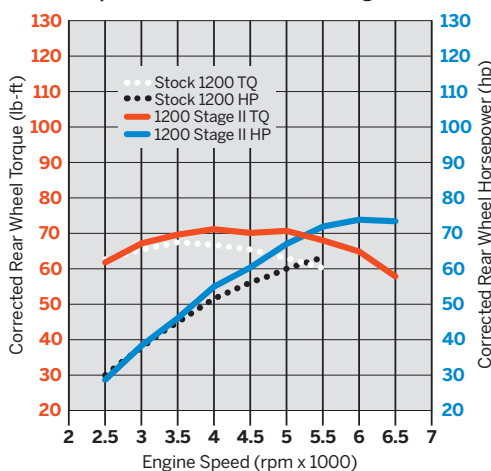

*'14-'22 XL1200 Stage II with Heavy Breather A/C & Street Cannon Mufflers

Street legal and/or street compliant statements refer to product meeting 50-State emissions and noise standards in the United States.

The street legal and/or street compliant statements may not apply to markets outside of the United States.

Notice: The prices appearing in this catalog are the manufacturer's suggested retail prices. Actual retail prices may vary.

STAGE IV

SCREAMIN' EAGLE® 403

Sportster® Stage IV Upgrade

SCREAMIN' EAGLE® SPORTSTER® CONVERSION KIT - 883CC TO 1200CC*

Make your Iron 883™ model roar. This complete conversion kit will alter the personality of your 883-equipped Sportster® model. Designed to bring your XL883 model up to XL1200 specifications. No case machining is required for installation. 50-State U.S. EPA compliant.

Kit includes:
Sportster High-Flow Air Cleaner Kit
XL1200 Cylinder Heads
XL1200 Cylinders
XL1200 Pistons and Rings
Heavy Duty Clutch Spring
Top End Gasket Kit

29784-07 Black Highlighted. **\$1,311.95**

Fits 50-state '07-'22 XL883 models. All models require ECM calibration for proper installation. '17-later models require recalibration with Screamin' Eagle® Pro Street Tuner (sold separately).

30003-10 Black Non-Highlighted. **\$1,311.95**

Fits 50-state '08-'22 XL883 models. All models require ECM calibration for proper installation. '17-later models require recalibration with Screamin' Eagle Pro Street Tuner (sold separately).

When installed by an authorized Harley-Davidson® Dealer within 60 days of the vehicle purchase, compliant kits do not impact the vehicle's limited warranty.



Sportster 883 Stock vs. 883 to 1200 Conversion*

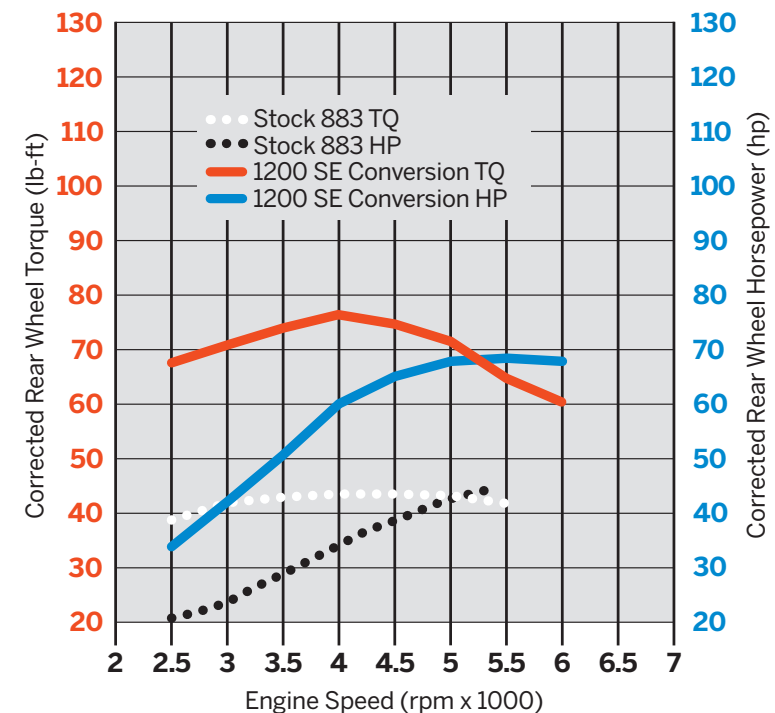

* 883 to 1200 Conversion with Street Cannon Mufflers

Street legal and/or street compliant statements refer to product meeting 50-State emissions and noise standards in the United States.

The street legal and/or street compliant statements may not apply to markets outside of the United States.

Notice: The prices appearing in this catalog are the manufacturer's suggested retail prices. Actual retail prices may vary.

404 SCREAMIN' EAGLE®

Sportster® Stage IV Upgrade

STAGE IV

SCREAMIN' EAGLE® SPORTSTER® STAGE IV KIT – 1200CC TO 1200CC

Maximize the horsepower and torque available for your street compliant Sportster® model. This complete engine package includes all the components you need to build a high-performance ride while still retaining the original factory warranty. Installation does not require removal of the powertrain from the chassis. 50-State U.S. EPA compliant. **Pending regulatory approval for '20-'22 models. Refer to the product information at www.H-D.com/shop for status.**

Kit includes:

- CNC-Ported Cylinder Heads with Performance Valve Springs
- Screamin' Eagle® XL SE-585 Cams
- Forged Hi-Compression 10.5:1 Pistons and Rings
- 58mm Throttle Body and Intake Manifold
- Top End Gasket Kit

Fits '14-'22 XL1200 models. Requires separate purchase of 58mm compatible accessory air cleaner. All models require ECM calibration for proper installation. '17-later models require recalibration with Screamin' Eagle Pro Street Tuner (sold separately). Pending approval for use in California on '21-later models. Refer to H-D.com/shop for status.

92500041	Black Highlighted Heads.	\$2,359.95
92500042	Black Non-Highlighted Heads.	\$2,359.95

When installed by an authorized Harley-Davidson® Dealer within 60 days of the vehicle purchase, compliant kits do not impact the vehicle's limited warranty.



SCREAMIN' EAGLE® 405

SCREAMIN' EAGLE® MULTI-FIT ACCESSORIES

When building a performance powertrain, don't overlook the small stuff. After all, good clean air and a powerful spark are essential for maximum power and engine life. Air cleaner covers and washable K&N® air filters are available to dress your bike in style while maximizing the flow of air to your engine, and Screamin' Eagle® premium spark plugs and plug wires will keep the fire burning.



Sportster 1200 Stock vs. 1200 Stage IV*

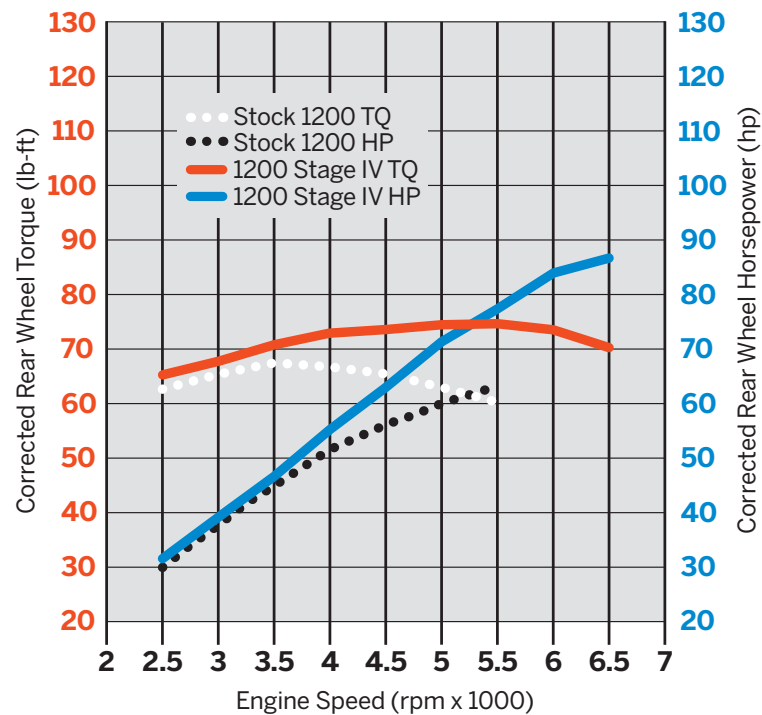

* 1200 Stage IV with 58MM Heavy Breather A/C & Street Cannon Mufflers

Street legal and/or street compliant statements refer to product meeting 50-State emissions and noise standards in the United States.

The street legal and/or street compliant statements may not apply to markets outside of the United States.

Notice: The prices appearing in this catalog are the manufacturer's suggested retail prices. Actual retail prices may vary.

406 SCREAMIN' EAGLE®

Air Filters

A. SCREAMIN' EAGLE® HIGH-FLO K&N® REPLACEMENT AIR FILTER ELEMENT

K&N® replacement air filters are engineered to improve airflow for increased horsepower and quicker acceleration. K&N filters provide excellent filtration, and because they are washable and reusable, you can clean the filter whenever conditions demand. Designed as direct replacements for specified fitments.

1. 29400020 High-Flow – Multi-fit. **\$83.95**
Fits '07-'22 XL, '99-'07 Dyna®, '00-'15 Softail® and '99-'07 Touring models equipped with High-Flow Air Cleaner Kits. Replacement for P/N 29442-99E.

2. 29400355 High-Flow – Multi-fit. **\$66.95**
Fits '18-later Softail and '17-later Touring and Trike models equipped with round High-Flow Air Cleaner P/N 29400355 or 29400356.

3. 29400019 High-Flow – Touring. **\$73.95**
Fits '16-'17 Softail and '08-'16 Touring and Trike models equipped with High-Flow Air Cleaner Kits. Replacement for P/N 29244-08.

4. 29400247 High-Flow – Wedge Milwaukee-Eight® Engine. **\$89.95**
Fits '17-later Touring and Trike models equipped with Wedge High-Flow Air Cleaner Kit P/N 29400245 or 29400246.

5. 29400065 Extreme Billet. **\$104.95**
Fits '15-'20 XG, '16-'17 Softail and '08-'16 Touring and Trike models equipped with Extreme Billet Agitator and Chisel Air Cleaner Kits.

5. 29400359 Extreme. **\$94.95**
Fits '18-later Softail and '17-later Touring and Trike models equipped with round High-Flow Air Cleaner P/N 29400357.

5. 29400118 Extreme Billet & Rail. **\$104.95**
Fits '07-'22 XL, '08-'17 Dyna and '08-'15 Softail and models equipped with Extreme Billet Chisel and Agitator or Rail Collection Air Cleaner Kits.

6. 29400109 Burst Collection. **\$66.95**
Fits '08-'17 Dyna and Softail models, '08-'16 Touring and Trike models equipped with Burst Collection Air Cleaner Kits.

7. 29400022A Ventilator – Multi-fit. **\$83.95**
Fits models equipped with Twin Cam Ventilator and Extreme Billet Ventilator Performance Air Cleaner Kits. Replacement for P/N 29670-09.

8. 29400293 Ventilator – Milwaukee-Eight Engine. **\$68.95**
Fits '18-later Softail, '17-later Touring and Trike models equipped with Ventilator Air Cleaner P/N 29400298 or 29400299.

9. 29424-05B Heavy Breather – Multi-fit, Chrome. **\$99.95**
Fits models equipped with Heavy Breather Kit P/N 29098-09, 29299-08, 29080-09 or 29264-08.

9. 29702-08B Heavy Breather – Touring, Chrome. **\$99.95**
Fits models equipped with Heavy Breather Kit P/N 29006-09B, 29253-08B, 29000065 or 29400105.

29400297 Heavy Breather – Touring, Black. **\$131.95**
Fits '16-'17 FXDLS and models equipped with Heavy Breather Kit P/N 29006-09B, 29253-08B, 29000065 or 29400105.

10. 28714-10 Heavy Breather – Compact, Chrome. **\$95.95**
Fits '08-'16 Touring and Trike models equipped with Compact Heavy Breather Kit P/N 28716-10A.

11. 29400141 Heavy Breather Elite, Chrome. **\$121.95**
Fits models equipped with Screamin' Eagle® Heavy Breather Elite Performance Air Cleaner Kit P/N 29400172 and 29400173.

27300139 Heavy Breather Elite, Black. **\$132.95**
Replacement air filter for models equipped with Screamin' Eagle Heavy Breather Elite Performance Air Cleaner Kit P/N 29400285.

12. 29400276 Heavy Breather – Milwaukee-Eight Engine, Black. **\$129.95**
Fits '18-later Softail, '17-later Touring and Trike models equipped with Heavy Breather Air Cleaner P/N 29400263 or 29400264.

13. 29400275 Heavy Breather – Milwaukee-Eight Engine, Chrome. **\$129.95**
Fits '18-later Softail, '17-later Touring and Trike models equipped with Heavy Breather Air Cleaner P/N 29400263 or 29400264.



A. SCREAMIN' EAGLE HIGH-FLO K&N REPLACEMENT AIR FILTER ELEMENT



Also available in Black

Also available in Black

A. SCREAMIN' EAGLE HIGH-FLO K&N REPLACEMENT AIR FILTER ELEMENT – HEAVY BREATHER



A. SCREAMIN' EAGLE HIGH-FLO K&N REPLACEMENT AIR FILTER ELEMENT – MILWAUKEE-EIGHT HEAVY BREATHER

SCREAMIN' EAGLE® 407

Spark Plugs

B. SCREAMIN' EAGLE® PERFORMANCE SPARK PLUGS

Screamin' Eagle® Spark Plugs feature double platinum coating for superior erosion resistance and extended life. The "V" trimmed ground electrode reduces shrouding of the flame front to promote flame propagation, and the fine wire center electrode enhances startups and ignitability. Screamin' Eagle Plugs feature Ribbed Core Technology (RCT) that provides resistance to fouling, and are designed with Original Equipment-style noise suppression to prevent electrical interference with radios and CB communication equipment. Works great in racing applications where rich air/fuel conditions are required. Unique style with Screamin' Eagle logo. Sold in pairs.

Standard Compression Applications

Designed for modified engines including performance carburetors, high-flow air cleaners, camshafts, exhaust systems and ignition systems in conjunction with stock compression ratios.

31600106 Standard Compression Applications. **\$23.95**
Fits '99-later Twin Cam-equipped models, and '86-later Evolution® Sportster® 883, 1100 and 1200 models.

31600085 Standard Compression Applications. **\$23.95**
Fits '15-'20 XG models and '17-later Milwaukee-Eight® engine equipped models.

High Compression Applications

These plugs are designed for high-performance applications involving modifications in high-flow air cleaners, camshafts, exhaust, performance heads, ignition components, higher compression ratios above Original Equipment configurations or engines specific for racing applications.

31600105 High Compression Applications. **\$23.95**
Fits '99-later Twin Cam-equipped models, '86-'22 XL and XR and Evolution 1340 models equipped with Screamin' Eagle Performance Cylinder Heads.

C. SCREAMIN' EAGLE 10MM PHAT SPARK PLUG WIRES – CUT TO LENGTH

Fat 10mm plug wires add dimension and style to your ride. Screamin' Eagle boot design and suppression core wires ensure solid connection and maximum voltage transfer between coil and plugs. Screamin' Eagle script printed along the wire to add style.

32095-98B Black. **\$37.95**
Multi-Fit – Cut to length. Fits '86-'03 XL models (except XL1200S), '91-'98 Dyna® models, '85-'99 Softail® models and '80-'84 Touring models.

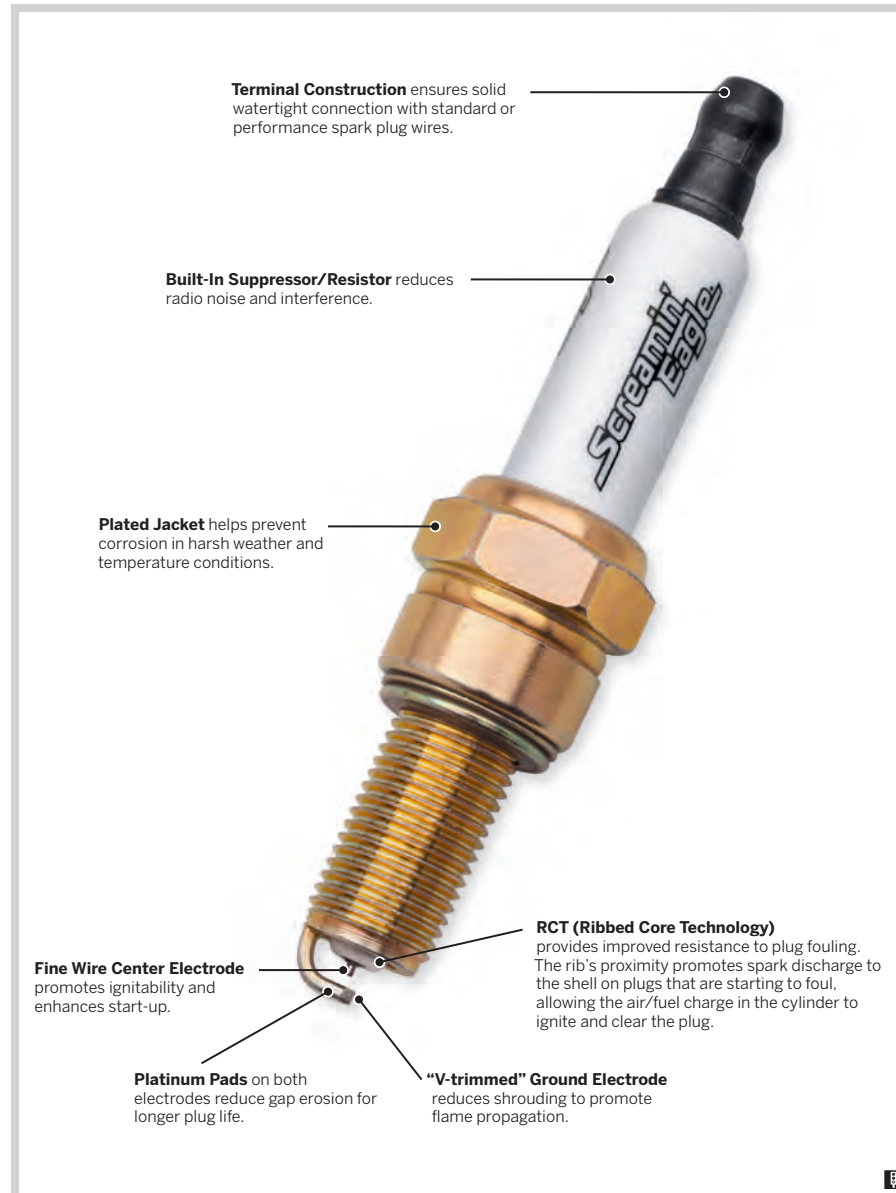

B. SCREAMIN' EAGLE PERFORMANCE SPARK PLUG



C. SCREAMIN' EAGLE 10MM PHAT SPARK PLUG WIRES – CUT TO LENGTH

Street legal and/or street compliant statements refer to product meeting 50-State emissions and noise standards in the United States.

The street legal and/or street compliant statements may not apply to markets outside of the United States.

Notice: The prices appearing in this catalog are the manufacturer's suggested retail prices. Actual retail prices may vary.

Notice: The prices appearing in this catalog are the manufacturer's suggested retail prices. Actual retail prices may vary.

408 SCREAMIN' EAGLE®

Spark Plug Wires

A. SCREAMIN' EAGLE® 10MM PHAT SPARK PLUG WIRES

Fat 10mm plug wires add dimension and style to your ride. Screamin' Eagle® boot design and suppression core wires ensure solid connection and maximum voltage transfer between coil and plugs. Screamin' Eagle script printed along the wire to add style.

Fits '15-'20 XG models.

31600048A	Black.	\$37.95
31600051A	Orange.	\$37.95
31600054A	Red.	\$37.95

Fits '07-'22 XL models.

31901-08A	Black.	\$37.95
31902-08A	Orange.	\$37.95

Fits '04-'06 XL models.

31958-04B	Black.	\$37.95
31956-04B	Orange.	\$37.95

Fits '86-'03 XL models (except XL1200S).

32092-98B	Black.	\$37.95
31963-89B	Orange.	\$37.95

Fits '99-'17 Dyna® models.

31930-99C	Black.	\$37.95
31944-99C	Orange.	\$37.95
31937-99C	Red.	\$37.95

Fits '91-'98 Dyna, '85-'99 Softail® and '80-'84 Touring models.

32093-98B	Black.	\$37.95
31964-89C	Orange.	\$37.95

Fits '18-later Softail models.

31600111	Black.	\$59.95
31600113	Orange.	\$59.95
31600112	Red.	\$59.95

Fits '00-'17 Softail models (except FXCW, FXCWC, FXS and '13-'16 FXSB models).

31907-08A	Black.	\$37.95
32360-00C	Orange.	\$37.95
32359-00C	Red.	\$37.95

Fits '08-'16 FXCW, FXCWC, FXS and FXSB models.

31965-08A	Black.	\$37.95
31967-08A	Red.	\$37.95

Fits '17-later Touring and Trike models.

31600108	Black.	\$59.95
31600110	Orange.	\$59.95
31600109	Red.	\$59.95

Fits '09-'16 Touring and Trike models.

32303-08A	Black.	\$37.95
32325-08A	Orange.	\$37.95
32318-08A	Red.	\$37.95

Fits '99-'08 Touring models.

31932-99C	Black.	\$37.95
31946-99C	Orange.	\$37.95
31939-99C	Red.	\$37.95



A. SCREAMIN' EAGLE 10MM PHAT SPARK PLUG WIRES – RED



A. SCREAMIN' EAGLE 10MM PHAT SPARK PLUG WIRES – ORANGE



A. SCREAMIN' EAGLE 10MM PHAT SPARK PLUG WIRES – BLACK



A. SCREAMIN' EAGLE 10MM PHAT SPARK PLUG WIRES

Street legal and/or street compliant statements refer to product meeting 50-State emissions and noise standards in the United States.

The street legal and/or street compliant statements may not apply to markets outside of the United States.

Notice: The prices appearing in this catalog are the manufacturer's suggested retail prices. Actual retail prices may vary.

SCREAMIN' EAGLE® 409

SCREAMIN' EAGLE® CRATE ENGINE & DRIVE TRAIN COMPONENTS

Fresh from the factory, Harley-Davidson® Crate Engines are the ideal platform for building your high-performance ride. And once you've put your heart and soul into achieving just the type of horsepower and torque numbers you crave, we offer everything you need to get all that power to the pavement.

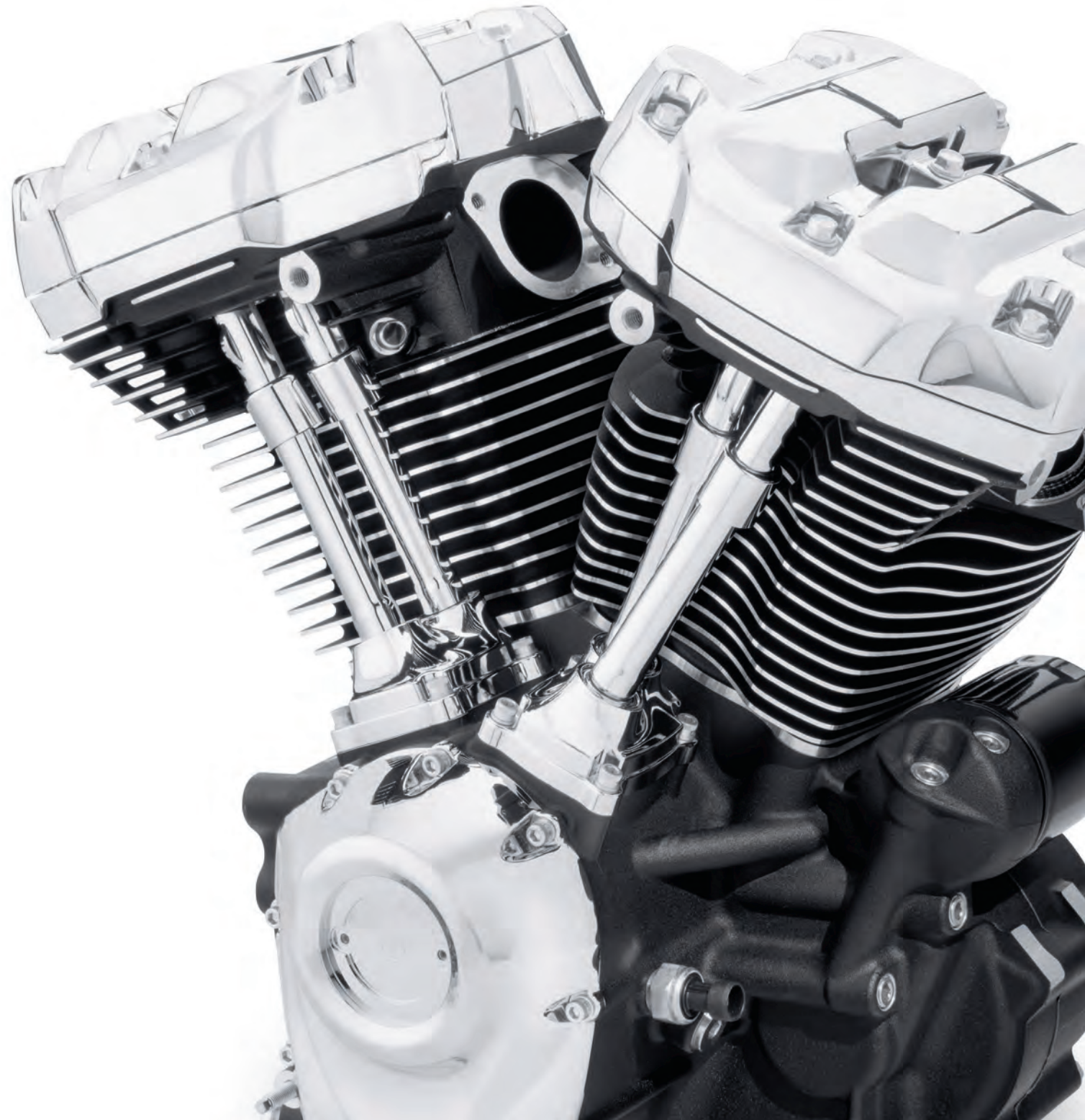

410 SCREAMIN' EAGLE®

Milwaukee-Eight® Engines

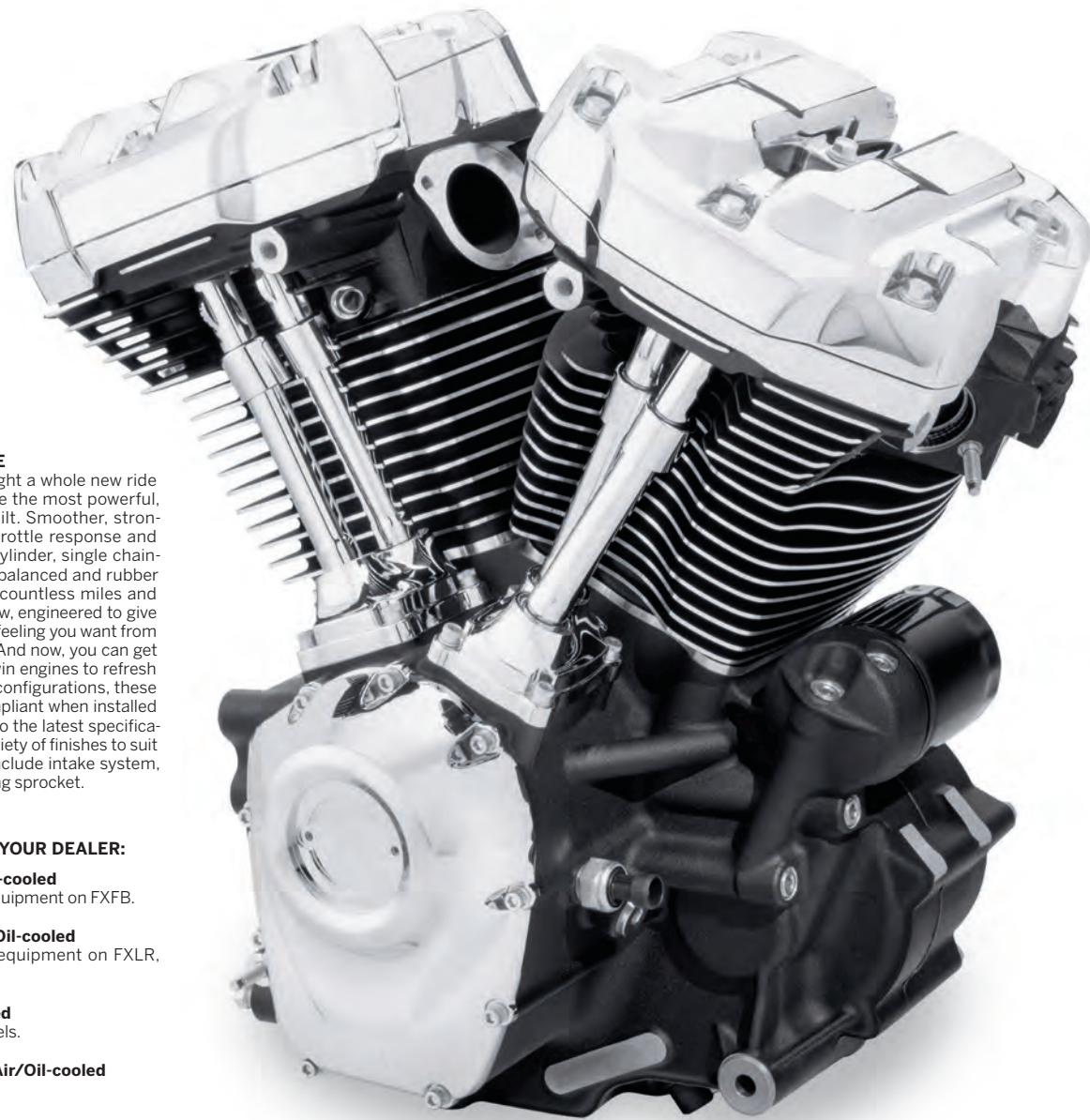

A. MILWAUKEE-EIGHT CRATE ENGINES

A. MILWAUKEE-EIGHT® CRATE ENGINE

The Milwaukee-Eight® engine has brought a whole new ride to the Harley-Davidson® family. They're the most powerful, coolest-running motors we've ever built. Smoother, stronger and more durable. With crisper throttle response and truer, cleaner sound. Four valves per cylinder, single chain-driven cam, dual spark plugs, counter-balanced and rubber mounted. Developed and proven over countless miles and millions of hours. Every single part is new, engineered to give you more performance and more of the feeling you want from an engine. Today, it's a whole new ride. And now, you can get the most technologically advanced V-Twin engines to refresh your ride. Available in 107CI and 114CI configurations, these Milwaukee-Eight engines are street compliant when installed in the models specified. Manufactured to the latest specifications, these engines are available in a variety of finishes to suit your customizing direction. Does not include intake system, timer cover, stator, rotor or compensating sprocket.

See your Dealer for details.

CRATE ENGINES AVAILABLE FROM YOUR DEALER:

107 Black with Black Covers – Air/Oil-cooled

Fits '18-later Softail® models. Original equipment on FXFB.

107 Black with Chrome Covers – Air/Oil-cooled

Fits '18-later Softail models. Original equipment on FXLR, FXBR, and FLDE.

107 Black and Chrome – Air/Oil-cooled

Fits '17-later Touring Air/Oil-cooled models.

107 Black with Gloss Black Covers – Air/Oil-cooled

Fits '17-later Touring models.

107 Black and Chrome – Twin-Cooled™

Fits '17-later Touring Twin-Cooled™ models.

114 Black with Black Covers – Air/Oil-cooled

Fits '18-later Softail models. Original equipment on FXFBS.

114 Black with Chrome Covers – Air/Oil-cooled

Fits '17-later Touring models. Original equipment on '18 FLRT.

114 Black with Chrome Covers – Air/Oil-cooled

Fits '18-later Softail models. Original equipment on FXBRS.

114 Black with Gloss Black Covers – Air/Oil-cooled

Fits '17-later Touring models.

114 Black with Chrome Cover – Twin-Cooled

Fits '17-later Touring Twin-Cooled models. Original equipment on '19 FLHTK.

NOTE: Replacement engines must be re-fitted with emission control devices and systems appropriate for the vehicle model and model year in order to ensure emissions compliance. Failure to do so constitutes tampering under U.S. EPA guidelines and can lead to substantial fines and penalties.

Legal for use on public roads only when installed in the specified models. Not legal for use on public roads when installed in models other than the ones specified and not eligible for the P&A 24-month warranty when installed in models other than the ones specified. Please see the Parts and Accessories warranty statement and your dealer for more information.

Street legal and/or street compliant statements refer to product meeting 50-State emissions and noise standards in the United States.

The street legal and/or street compliant statements may not apply to markets outside of the United States.



B. MILWAUKEE-EIGHT CRATE ENGINES

Milwaukee-Eight 131 Stage IV Softail vs 114 Softail Stock

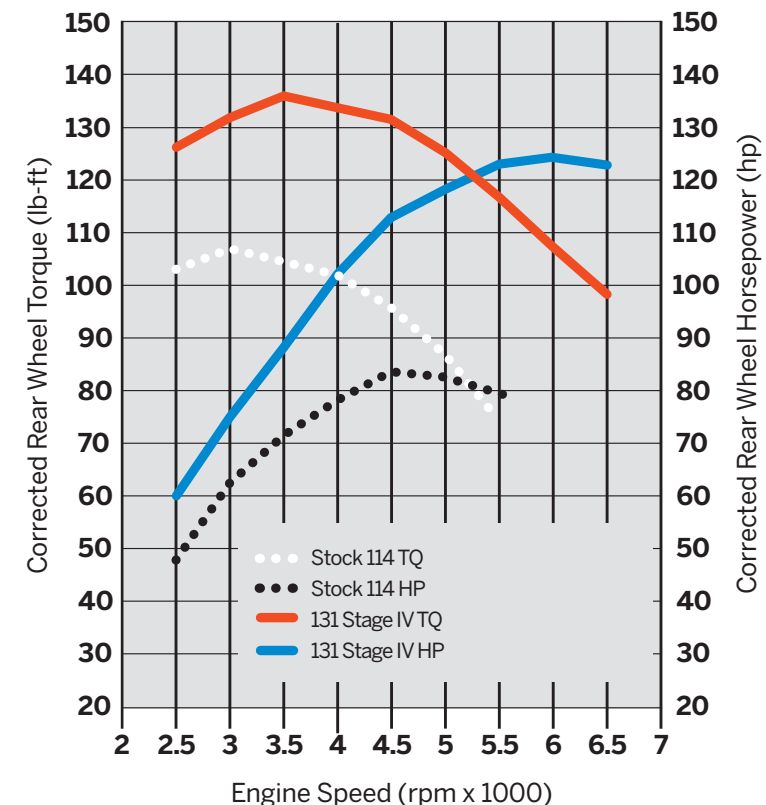

SCREAMIN' EAGLE® 411

Milwaukee-Eight® Engines

B. SCREAMIN' EAGLE® MILWAUKEE-EIGHT® ENGINE 131 PERFORMANCE CRATE ENGINE

Leave other riders in the dust with the biggest, most powerful street-compliant crate performance engine Harley-Davidson has ever created. Built from the bottom up in Milwaukee, this street-tuned 131-cubic-inch Screamin' Eagle® Crate Engine is designed to run with a wide open throttle at high engine speeds and provide instant passing power from cruising speed. Made for riders seeking maximum displacement, compression and flow, it delivers 131 ft-lb of torque to the rear wheel as soon as the throttle is cranked. Stage IV equipped engine includes 131 Stage IV badging on the cylinder heads and timer cover to highlight the powerplant. Ready for bolt-in installation in the Original Equipment-style chassis of your Touring bike. No special fabrication or engine-mount relocation is required. Engine features one-year manufacturer's warranty for unmatched confidence. Eligible for coverage under factory vehicle warranty when dealer-installed within 60 days of vehicle purchase.

Designed and tested at the Harley-Davidson® powertrain factory to ensure the highest quality construction, this street-ready performance motor features the finest Screamin' Eagle components:

- Engraved CNC-ported cylinder head with CNC-machined chamber and 1mm larger valves.
- SE8-517 high-lift cam
- High-compression forged pistons
- High-performance cam bearing
- High-performance tappets
- Patent-protected 4.31" steel sleeve cylinders.
- 64mm throttle body and cast manifold.
- 5.5 g/sec fuel injectors

49-State U.S. EPA Compliant on select '17-later Touring models.

Refer to www.H-D.com/Shop for status.

Fits '17-later Touring models equipped with air/Oil-Cooled Milwaukee-Eight® engine. Does not fit Trike models. Requires separate purchase of Head Pipe P/N 65600177 and Oil Cooler Fan Assist P/N 62700204 or Fan for Factory Oil Cooler P/N 26800195. '17-'18 models require separate purchase of Screamin' Eagle High-Capacity Clutch Plate Kit P/N 37000258. All models require ECM recalibration with Screamin' Eagle Pro Street Tuner for proper installation. Does not fit California models.

16200339 Oil Cooled - Black & Chrome. **\$6,971.00**

16200340 Oil Cooled - Black & Gloss Black. (shown) **\$6,971.00**

Fits '17-later Touring models equipped with Twin-Cooled™ Milwaukee-Eight engine. Does not fit Trike models. Requires separate purchase of Head Pipe P/N 65600177. '17-'18 models require Screamin' Eagle High-Capacity Clutch Plate Kit P/N 37000258. All models require ECM recalibration with Screamin' Eagle Pro Street Tuner for proper installation. 49-State U.S. EPA compliant. Does not fit California models.

16200521 Twin-Cooled™ - Black & Chrome. **\$7,196.00**

16200522 Twin Cooled - Black & Gloss Black. **\$7,196.00**

NOTE: Replacement engines must be re-fitted with emission control devices and systems appropriate for the vehicle model and model year in order to ensure emissions compliance. Failure to do so constitutes tampering under U.S. EPA guidelines and can lead to substantial fines and penalties.

Legal for use on public roads only when installed in the specified models. Not legal for use on public roads when installed in models other than the ones specified and not eligible for the P&A 24-month warranty when installed in models other than the ones specified. Please see the Parts and Accessories warranty statement and your dealer for more information.

Street legal and/or street compliant statements refer to products meeting EPA (49-State) and/or California (50-State) emissions and noise standards in the United States as specified.

The street legal and/or street compliant statements may not apply to markets outside of the United States.

Notice: The prices appearing in this catalog are the manufacturer's suggested retail prices. Actual retail prices may vary.

SCREAMIN' EAGLE

412 SCREAMIN' EAGLE®

Milwaukee-Eight® Engines

A. SCREAMIN' EAGLE® MILWAUKEE-EIGHT® ENGINE 131 CI PERFORMANCE CRATE ENGINE

Leave other riders in the dust with the biggest, most powerful street-compliant crate performance engine Harley-Davidson has ever created. Built from the bottom up in Milwaukee, this street-tuned 131-cubic-inch Screamin' Eagle® Crate Engine is designed to run with a wide-open throttle at high engine speeds and provide instant passing power from cruising speed. Made for riders seeking maximum displacement, compression and flow, it delivers 135 ft-lb of torque to the rear wheel as soon as the throttle is cranked. Stage IV equipped engine includes 131 Stage IV badging on the cylinder heads and timer cover to highlight the powerplant. Ready for bolt-in installation in the Original Equipment-style chassis of your Softail® bike. No special fabrication or engine-mount relocation is required. Engine features one-year manufacturer's warranty for unmatched confidence. Eligible for coverage under factory vehicle warranty when dealer-installed within 60 days of vehicle purchase.

49-State U.S. EPA Compliant on select '18-later Softail® Models. Refer to www.H-D.com/Shop for status.

Performance components include:

- Engraved CNC-ported cylinder head with CNC-machined chamber and 1mm larger valves
- SE8-517 high-lift cam
- High-compression 10.7:1 forged pistons.
- High-performance cam bearing
- High-performance tappets
- Patent-protected 4.31" steel sleeve cylinders.
- 64mm throttle body and cast manifold
- 5.5 g/sec fuel injector

Fits '18-later Softail® models. FXFB and FXFBS models require separate purchase of Screamin' Eagle Softail High-Flow Exhaust System P/N 64900828 or 64900829. '18 107ci models require separate purchase of SE High-Capacity Clutch Plate Kit P/N 37000258. FXDR114 models require the separate purchase of 65600300. All models require ECM calibration with Screamin' Eagle Pro Street Tuner for proper installation. Does not fit California models.

16200341	Black & Chrome.	\$6,971.00
16200342	Black & Gloss Black.	\$6,971.00



A. SCREAMIN' EAGLE® MILWAUKEE-EIGHT® ENGINE 131 CI PERFORMANCE CRATE ENGINE

Milwaukee-Eight 114 Softail Stock vs. 131 Softail Crate Engine w/ Ventilator A/C

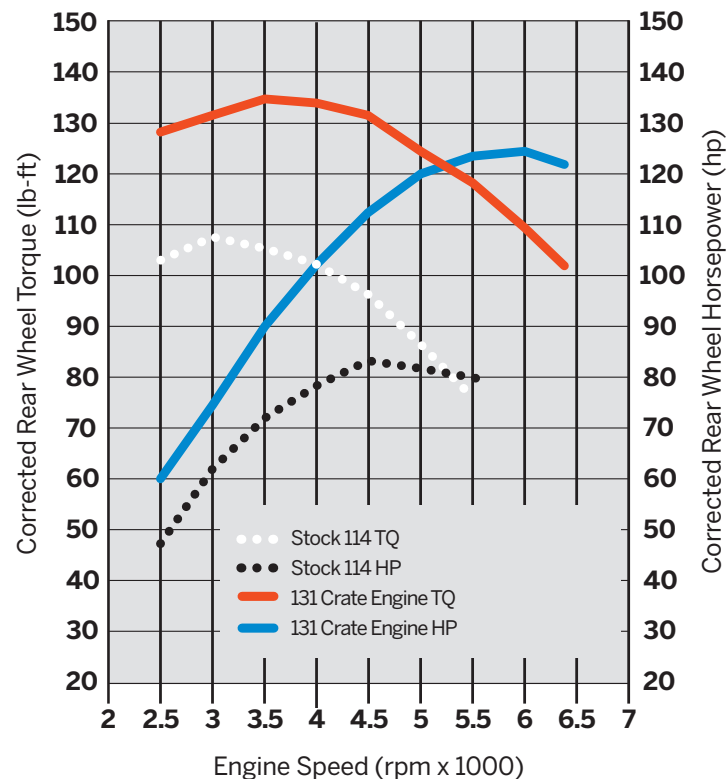

Street legal and/or street compliant statements refer to products meeting EPA (49-State) and/or California (50-State) emissions and noise standards in the United States as specified.

The street legal and/or street compliant statements may not apply to markets outside of the United States.

NOTE: Replacement engines must be re-fitted with emission control devices and systems appropriate for the vehicle model and model year in order to ensure emissions compliance. Failure to do so constitutes tampering under U.S. EPA guidelines and can lead to substantial fines and penalties.

Legal for use on public roads only when installed in the specified models. Not legal for use on public roads when installed in models other than the ones specified and not eligible for the P&A 24-month warranty when installed in models other than the ones specified. Please see the Parts and Accessories warranty statement and your dealer for more information.

SCREAMIN' EAGLE® 413

Twin Cam SE120ST Crate Motor

B. SCREAMIN' EAGLE® SE120ST STREET PERFORMANCE CRATE MOTOR

This street-tuned 120-cubic-inch Screamin' Eagle® Crate Motor takes your bagger from mild to wild. This engine is designed for bolt-in installation in the Original Equipment-style chassis of your Touring bike. No special fabrication or engine mount relocation is required. The crankcase, cylinders and heads are painted black, and feature machined aluminum highlights and chrome covers for a stunning "show-and-go" look. Equipped with the ultimate large bore Screamin' Eagle 58mm Throttle Body (18% larger than stock), this engine is capable of producing 106 horsepower and 117 lb-ft of torque at the rear wheel. Engine features one-year manufacturer's warranty. For best performance results, we recommend combining this engine with your choice of Screamin' Eagle 58mm High-Flow Air Cleaner and the Screamin' Eagle High Flow Exhaust System P/N 64800022.

This engine is 50-State U.S. EPA compliant when used with Original Equipment mufflers or the Screamin' Eagle Street Performance Exhaust System P/N 64800022. All models require ECM calibration (priced separately). U.S. delivered engines include Manufacturer's Statement of Origin (MSO).

Developed and tested in Milwaukee, this motor features the finest Screamin' Eagle components:

- 4.060 big-bore cylinders.
- 4-5/8" stroke SE Pro stroker flywheel and rod assembly.
- 10.5:1 high-compression nickel-plated forged pistons with Teflon® coated skirt.
- Titanium SST piston rings.
- SE-259E high-lift cams.
- Perfect-Fit pushrods.
- SE high-performance lifters.
- CNC-ported MVA heads with automatic compression release.
- Screamin' Eagle Pro High-Flow 58mm EFI Throttle Body, high-flow injectors and manifold clamps.
- Machined lower rocker boxes for valve spring collar clearance.
- Factory-machined engine cases.
- Unique piston oilers for stroker clearance.
- Screamin' Eagle inner crankcase full complement cam needle bearings.
- SE Lefty high-performance crankcase output bearing and nitride bearing race.
- SE Performance spark plugs.
- 120ST cam cover and cylinder head medallions.

19221-15 \$6,699.95

Fits 50-state '10-'16 Touring models. Does not fit Twin-Cooled™ models. Does not fit Trike. '10 Touring models require Screamin' Eagle Big Twin Compensator Kit P/N 40100061. All models require ECM calibration for proper installation. '10-'13 Touring models can be programmed by Dealer (sold separately). '14-'16 Touring models can be calibrated using the Screamin' Eagle Pro Street Tuner (sold separately).



Twin Cam 103HO Stock vs. SE120ST Crate Motor with Stock Exhaust

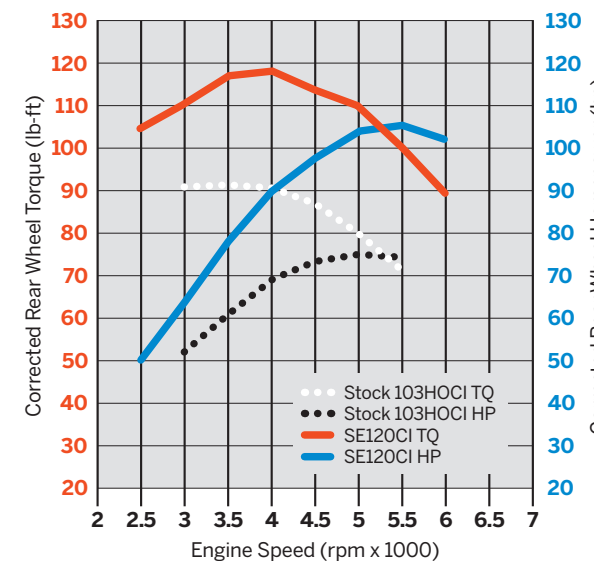

Street legal and/or street compliant statements refer to product meeting 50-State emissions and noise standards in the United States.

The street legal and/or street compliant statements may not apply to markets outside of the United States.

Notice: The prices appearing in this catalog are the manufacturer's suggested retail prices. Actual retail prices may vary.

414 SCREAMIN' EAGLE®

Clutch & Drivetrain

A. SCREAMIN' EAGLE® HIGH CAPACITY CLUTCH KIT – MILWAUKEE-EIGHT® ENGINE

The Screamin' Eagle® High Capacity Clutch Kit increases the drivetrain's ability to reliably support high torque applications without significantly increasing lever effort. Designed to fit in the stock clutch basket, this kit provides smooth shifting, progressive engagement, and works with the factory Assist and Slip clutch system to keep clutch lever effort similar to the stock levels. Kit contains 10 fiber clutch plates and 10 contact plates – one more than Original Equipment – and 3-1200 Newton clutch springs. This combination provides 11% more clutch surface area for greater power handling capability.

37000287 **\$265.95**
Fits '18-later Softail® and '17-later Touring models.

B. SCREAMIN' EAGLE HIGH CAPACITY CLUTCH PLATE KIT – MILWAUKEE-EIGHT ENGINE

Replacement clutch plates for the Screamin' Eagle High Capacity Clutch Kit P/N 37000287. Kit includes 9 fiber friction plates and 10 contact plates.

37000258 **\$243.95**
Fits '18-later Softail and '17-later Touring models.

C. MILWAUKEE-EIGHT ENGINE CLUTCH SPRINGS – 1275N

High-tension springs are engineered to add additional clutch capacity in high torque and high horsepower applications. Kit includes 3-1275 Newton (N) coil springs, and is designed to complement the Screamin' Eagle High Capacity Clutch Plate Kit P/N 37000258. When combined with the High Capacity Clutch Plate Kit, torque capacity is increased to the maximum level available. Installation will increase capacity and lever effort. Springs can be installed without removing the outer primary cover.

37000286 **\$33.95**
Fit's '18-later Softail and '17-later Touring models.

D. MILWAUKEE-EIGHT ENGINE CLUTCH SPRINGS – 1200N

Replacement clutch springs for the Screamin' Eagle High Capacity Clutch Kit P/N 37000287. Kit includes 3-1200 Newton (N) coiled clutch springs. Installation of these springs with Original Equipment clutch plates will increase clutch capacity and lever effort. Springs can be installed without removing the outer primary cover. Included in Milwaukee-Eight® Stage III and IV Kits.

37000288 **\$33.95**
Fit's '18-later Softail and '17-later Touring models.



A. SCREAMIN' EAGLE HIGH CAPACITY CLUTCH KIT – MILWAUKEE-EIGHT ENGINE

Configuration	Max Crankshaft Torque (ft. lbs.)	% Increase in Torque Capacity Over Milwaukee-Eight® 107 OE Clutch	Approximately Lever Effort (lb)
Milwaukee-Eight 107Cl Original Equipment (9-Disk/1100N Spring)	125	—	14.6
9 Disk/1200N Spring	134	7.2%	16
9 Disk/1275 Spring	143	14.4%	17
Milwaukee-Eight 114Cl Original Equipment (10 Disk/1100N Spring) (P/N 37000287)	139	11.2%	14.6
Screamin' Eagle High Capacity Clutch Kit 10 Disk/1200N Spring	150	20%	16
10 Disk/1275N Spring	160	28%	17



B. SCREAMIN' EAGLE HIGH CAPACITY CLUTCH PLATE KIT – MILWAUKEE-EIGHT ENGINE



C. MILWAUKEE-EIGHT ENGINE CLUTCH SPRINGS – 1275N



D. MILWAUKEE-EIGHT ENGINE CLUTCH SPRINGS – 1200N



E. SCREAMIN' EAGLE BIG TWIN COMPENSATOR

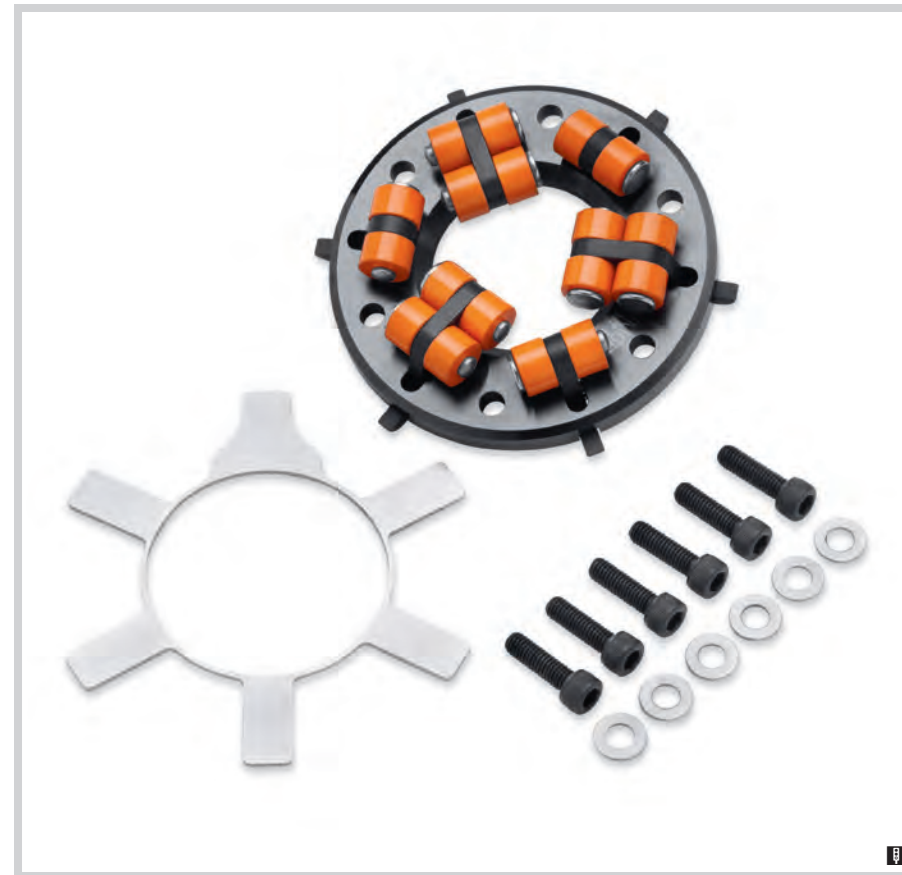

F. SCREAMIN' EAGLE VARIABLE PRESSURE CLUTCH

SCREAMIN' EAGLE® 415

Clutch & Drivetrain

E. SCREAMIN' EAGLE® BIG TWIN COMPENSATOR

This premium compensator has been engineered with heavier springs and increased travel to support the high torque output associated with high-compression race and large displacement engines. Designed to outperform the Original Equipment compensator, this unit helps protect the engine and driveline components during harsh drag race launches. Compensator features improved oil passages, oil deflectors and a needle bearing thrust washer that improves the overall operation of these components.

4220064A **\$329.95**
Fits '12-'13 Dyna®, '12-'13 Softail® (except FXCW, FXCWC, FXSB, FXSBSE and '09 FXSTSSE), '11-'13 Touring and '09-'13 Trike models. Original Equipment on '14-'17 Dyna, Softail and '14-'16 Touring models. Requires separate purchase of Installation Adhesive Kit P/N 11100088.

4010061 **\$449.95**
Fits '06-'11 Dyna, '07-'11 Softail (except FXCW and FXCWC), '07-'10 Touring, and '07-'09 CVO™ (except '09 FXSTSSE) models. Does not fit Trike. Requires separate purchase of Installation Adhesive Kit P/N 11100088. Kit includes Rotor Assembly P/N 30041-08. Installation on '06 Dyna models require separate purchase of '07-style stator.

4220095A **\$329.95**
Fits '08-'12 FXCWC and '09 FXSTSSE models and '13-later FXSB models. If P/N 40274-08A has been installed previously, the rotor shell, P/N 30041-08A is not required.

F. SCREAMIN' EAGLE VARIABLE PRESSURE CLUTCH

Get more performance from the Original Equipment clutch. The Screamin' Eagle® Variable Pressure Clutch is designed to help put the added power from a Screamin' Eagle Stage Kit to the pavement. This bolt-on kit harnesses the centrifugal force of spinning weights to increase the clutch capacity as engine speed increases. The mechanism applies increasing pressure to the stock clutch pressure plate as RPM rises. The result: high torque-handling capabilities without increasing clutch lever effort at idle. The Variable Pressure Clutch also provides smoother clutch disengagement at lower speed. Kit fits behind most stock derby covers with no modifications. See installation manual for additional accessory derby cover fitment information.

To match the performance demands of your engine, team the Variable Pressure Clutch with your choice of clutch diaphragm springs. We recommend the higher-capacity Screamin' Eagle Diaphragm Spring P/N 37951-98 for major performance upgrades.

	Lever Effort	Torque Capacity
Original Equipment Spring	Same as stock	120 ft-lbs
SE Spring P/N 37951-98	35% greater than stock	153 ft-lbs

37000121A **\$329.95**
Fits '99-'17 Evolution® 1340 and Twin Cam-equipped models. Will not fit '16-later Touring and Trike models, '15-later FLHTCUL or FLHTKL models or '07-later Touring or Trike models equipped with Narrow-Profile Outer Primary Cover P/N 25700385 or 25700438. Will not fit '13-later CVO models with hydraulic actuated clutch, '16-'17 FXDL, FLSS and FLSTFBS, or '14-later Touring and Trike models equipped with Screamin' Eagle A&S Clutch Kit P/N 37000026. Derby Covers P/N 25001-03, 25441-04A, 25770-99, 25331-10, 25339-10, 25700250 and 25700062 require Spacer Kit P/N 37000123. Does not fit Derby Covers P/N 25347-02 or 25345-01.

Street legal and/or street compliant statements refer to product meeting 50-State emissions and noise standards in the United States.

The street legal and/or street compliant statements may not apply to markets outside of the United States.

Notice: The prices appearing in this catalog are the manufacturer's suggested retail prices. Actual retail prices may vary.

Street legal and/or street compliant statements refer to product meeting 50-State emissions and noise standards in the United States.

The street legal and/or street compliant statements may not apply to markets outside of the United States.

Notice: The prices appearing in this catalog are the manufacturer's suggested retail prices. Actual retail prices may vary.

416 SCREAMIN' EAGLE®

Clutch & Drivetrain

A. SCREAMIN' EAGLE® TWIN CAM PERFORMANCE ASSIST AND SLIP (A&S) CLUTCH KIT

Developed for the high-thrust 110CI engine featured as Original Equipment on '14-later CVO™ models, this A&S clutch provides significantly increased torque-handling capacity (135lb/ft). Clutch is designed to improve engagement grip and provides minor slippage during downshifting to reduce shock to the power train. Reduces hand lever pull effort by over 1 pound. Complete kit features improved clutch plates for enhanced wear resistance and is the perfect addition when installing a high-output Screamin' Eagle® Stage Kit.

37000026 \$437.95

Fits '14-'16 Touring and Trike models with hydraulic clutch actuator. Original Equipment on FXDLS, FLSS, FLSTBS and FXSE models.

B. SCREAMIN' EAGLE PERFORMANCE CLUTCH FRICTION DISC KIT

Newly developed friction material delivers longer life than Original Equipment friction discs. Kit includes new precision-machined flat steel plates. This Friction Disc Kit is a perfect match for the Screamin' Eagle Twin Cam Performance Race Clutch Hub Kit P/N 37976-08.

37980-10 \$196.95

Fits '99-'17 Twin Cam-equipped models and '98-'99 Evolution® 1340-equipped models. Will not fit '13-'16 CVO™ Touring models with hydraulic actuated clutch or, '15-'16 FLHTCUL and FLHTKL, '16-'17 FXDLS, FLSS, FLSTFBS, FXSE or '13-'16 CVO Touring models with hydraulic actuated clutch, '15-'16 FLHTCUL and FLHTKL or '14-'16 Touring and Trike models equipped with Screamin' Eagle A&S Clutch Kit P/N 37000026.

C. HEAVY DUTY CLUTCH SPRING FOR STOCK CLUTCH

37951-98 \$39.95

Fits '99-'17 Twin Cam-equipped models and '98-'99 Evolution 1340-equipped models. Will not fit '16-'17 FXDLS, FLSS, FLSTFBS and FXSE or '13-'16 CVO Touring models with hydraulic actuated clutch, or '15-'16 FLHTCUL and FLHTKL, '14-'16 Touring and Trike models equipped with Screamin' Eagle A&S Clutch Kit P/N 37000026.

D. SCREAMIN' EAGLE PERFORMANCE CLUTCH KIT

Performance Clutch Kit converts the 8-plate clutch to a 9-plate design. The surface area is increased by 13% and the spring rate is increased by 10% for a combination that can handle over 115 ft-lbs of torque at the crank, a 23% increase over the stock-rated capacity. Kit includes Kevlar® fiber-based friction discs and performance clutch spring.

38002-04 \$219.95

Fits '91-'22 XL and '94-'97 Evolution 1340-equipped models.

E. SCREAMIN' EAGLE PERFORMANCE SLIPPER CLUTCH FOR VRSC™ MODELS

This clutch offers reduced lever effort and improved performance. The unique "slip and assist" ramp system opens the two halves of the clutch hub slightly during high loads to the drivetrain, allowing a moderate slip that reduces shock to the drivetrain during rapid downshifting. The resulting reduction in wheel hop allows maximum contact between the tire and the road in wet or slippery conditions. Clutch lever effort is also reduced by 20% in 1130cc and 30% on 1250cc applications.

37938-08KA \$263.95

Fits '02-'07 VRSC™ models.



A. SCREAMIN' EAGLE TWIN CAM PERFORMANCE ASSIST AND SLIP CLUTCH KIT



B. SCREAMIN' EAGLE PERFORMANCE CLUTCH FRICTION DISC KIT



C. HEAVY DUTY CLUTCH SPRING FOR STOCK CLUTCH



D. SCREAMIN' EAGLE PERFORMANCE CLUTCH KIT



E. SCREAMIN' EAGLE PERFORMANCE SLIPPER CLUTCH FOR VRSC MODELS



F. TWIN CAM SHORTBLOCK ASSEMBLY – DYNA AND TOURING



F. TWIN CAM SHORTBLOCK ASSEMBLY – SOFTAIL

SCREAMIN' EAGLE® 417

Shortblock Program

SHORT & LONGBLOCK PROGRAM

When it comes time to repower your motorcycle, the first stop should be your local Harley® Dealer. They can set you up with a replacement shortblock or longblock engine that is manufactured from 100% new Original Equipment parts and subjected to the same rigorous testing as all Harley engines. Plus, all longblock engines feature a one-year factory warranty and your original VIN stamped on the case.

F. SHORTBLOCK ASSEMBLY

The perfect starting point for building the engine of your dreams. Engine shortblocks are manufactured and assembled on Harley-Davidson's main engine assembly line for exceptional quality and reliability. Shortblock cases, flywheels, bearings and rods are preassembled and ready for your custom build. Kit includes current spec Original Equipment cam plate, oil pump, cam drive components and the gaskets, seals and most of the hardware required to complete the engine and install it (not all components shown). You select your cylinders, heads, cams, covers and other top-end components. Choose one of the Screamin' Eagle® Stage kits to incorporate reliable performance and pick from our decorative engine covers to customize the look. Shortblock Assemblies are stamped with a new VIN and include MSO (Manufacturers Statement of Origin). The MSO is for Domestic only. Kits ship directly from the factory within 3-5 days. Assembly comes stamped with a new VIN on Twin Cam Kits. (For VIN matching shortblock assemblies see the appropriate Service Parts Catalog.)

Twin Cam Engine

16200070 Black 96CI/103CI. **\$2,989.00**
Fits '07-'17 Dyna® (except FXDLS), and '07-'16 Touring and Trike models (except CVO™).

16200071 Black 96CI/103CI. **\$3,913.00**
Fits '07-'17 Softail® models (except FLSS, FLSTFBS and CVO).

Milwaukee-Eight® Engine (not shown)

See your Dealer for details.

NOTE: Replacement engines must be re-fitted with emission control devices and systems appropriate for the vehicle model and model year in order to ensure emissions compliance. Failure to do so constitutes tampering under U.S. EPA guidelines and can lead to substantial fines and penalties.

Legal for use on public roads only when installed in the specified models. Not legal for use on public roads when installed in models other than the ones specified and not eligible for the P&A 24-month warranty when installed in models other than the ones specified. Please see the Parts and Accessories warranty statement and your dealer for more information.

Street legal and/or street compliant statements refer to product meeting 50-State emissions and noise standards in the United States.

The street legal and/or street compliant statements may not apply to markets outside of the United States.

Notice: The prices appearing in this catalog are the manufacturer's suggested retail prices. Actual retail prices may vary.

Street legal and/or street compliant statements refer to product meeting 50-State emissions and noise standards in the United States.

The street legal and/or street compliant statements may not apply to markets outside of the United States.

Notice: The prices appearing in this catalog are the manufacturer's suggested retail prices. Actual retail prices may vary.

418 SCREAMIN' EAGLE®

LongBlock Program

HARLEY-DAVIDSON® LONGBLOCK PROGRAM

Your engine is the heart and soul of your Harley-Davidson® motorcycle. When the miles start to add up, a Harley-Davidson® LongBlock can put the rumble back in your ride simply, quickly and affordably.

WHY SHOULD I CONSIDER A LONGBLOCK? Unlike an engine rebuild from the repair shop down the street, the Harley-Davidson® LongBlock is manufactured from 100% new Original Equipment components, and is built to the latest factory specifications. Engine includes upgraded Screamin' Eagle® lefty crankcase bearing, Screamin' Eagle cam bearings and Screamin' Eagle performance tappets to handle higher-stress loads and performance upgrades. In addition, '99-'06 LongBlocks are upgraded with late-model hydraulic cam tensioners, high-volume oil pump and billet cam plate. '07-'16 103CI and 110CI engines feature factory-installed Automatic Compression Releases.

WHAT DOES THE H-D® LONGBLOCK INCLUDE? The crankcase is pre-assembled with flywheels, connecting rods, bearings, seals, cylinders, pistons, rings, heads, valves, valve springs, tappets and pushrod covers. Also included and ready for Dealer installation are top end rocker arm supports, rocker arms and shafts, pushrods and breathers. The LongBlock also includes cam support plate, cam plate bearings, cam and timing chain drive, hydraulic tensioners and all required gaskets and new hardware.

ARE UPGRADES AVAILABLE?* You can choose silver or black-highlighted engines to match your styling direction. Bikes originally equipped with Twin Cam 88® engines can upgrade to 95 or 103CI displacement, and Twin Cam 96™-equipped models can be repowered with 103 or 110CI engines, based on specific model fitment. Upgrades require model-specific ECM recalibration (sold separately). Only available in North America.

WHAT ELSE DO I NEED? LongBlock is sold without cam shafts, lower rocker boxes, upper rocker box covers or cam cover. You have the option to reinstall your current cams and covers, or select from a wide assortment of performance and custom engine cover options.

FAST AND EASY: Just take your Harley® motorcycle to your authorized dealership. They will remove the engine from the frame, ship the left crankcase half to Harley-Davidson and in a short time, you will have a new LongBlock back, ready for the dealer to reinstall in your bike. Your engine retains its original vehicle identification number (VIN) for easy title exchange and registration.

**Displacement upgrades are available for vehicles previously equipped with street compliant big bore kits only.*

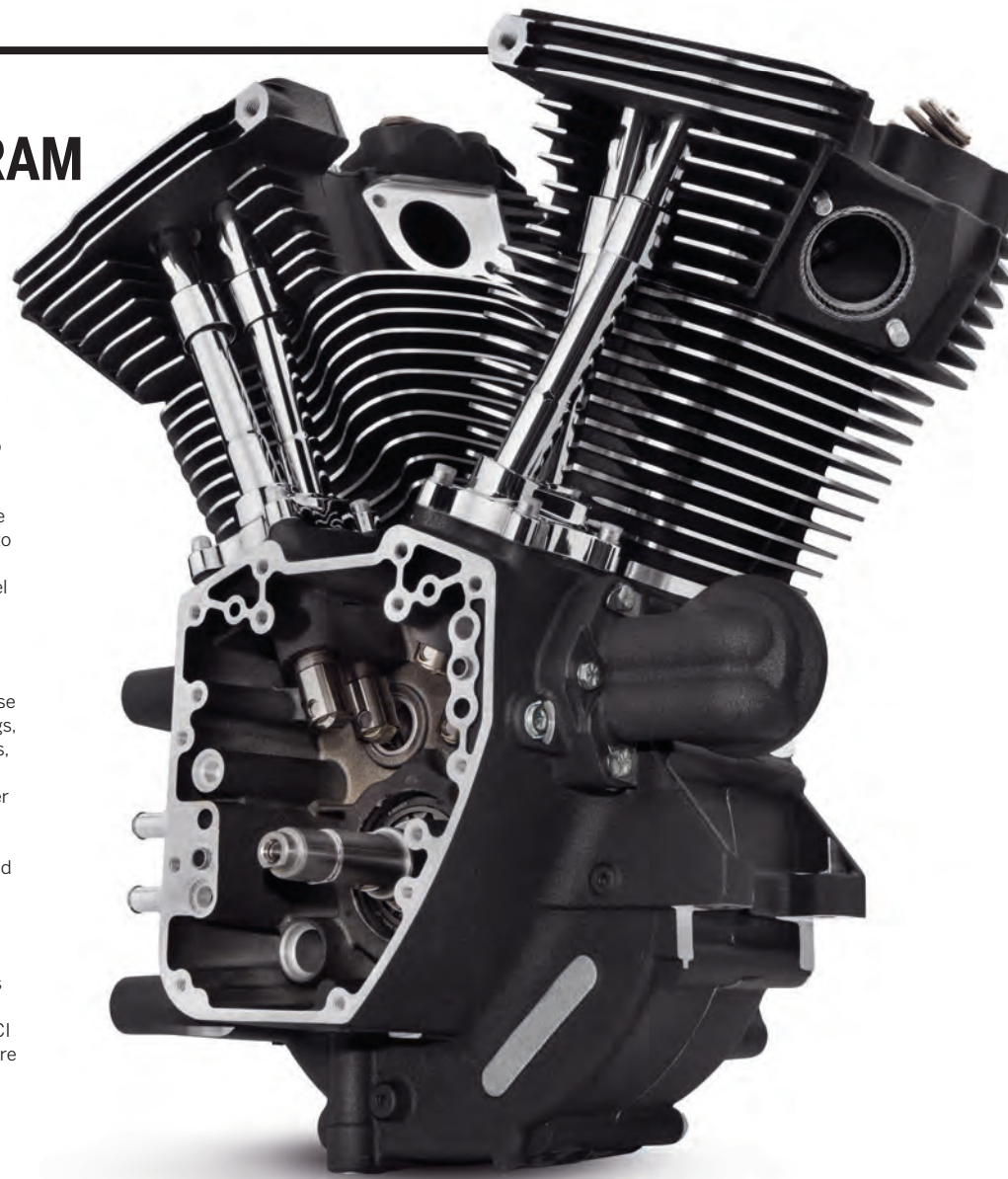

Available to fit:

'07-'17 Softail® models.

16200104	Twin Cam 103 – Black.*	\$5,834.00
16200108	Twin Cam 110™ – Black.*	\$5,834.00
16200109	Twin Cam 110 – Granite.*	\$6,137.00

'99-'05 Dyna® and '99-'06 Touring models.

16200085	Twin Cam 88 – Black.	\$5,126.00
16200086	Twin Cam 88 – Silver.	\$5,126.00

'04-'05 EFI Dyna® and '99-'06 EFI Touring models.

16200091	Twin Cam 95 – Black.*	\$4,426.00
16200092	Twin Cam 95 – Silver.*	\$4,426.00

'03-'06 EFI Touring models.

16200095	Twin Cam 103 – Black.*	\$5,126.00
16200096	Twin Cam 103 – Silver.*	\$5,126.00

'07-'17 Dyna and '07-'16 Touring models (Includes ACR – Auto Compression Release).

16200103	Twin Cam 103 – Black.*	\$5,126.00
16200105	Twin Cam 110 – Black.*	\$5,266.00
16200106	Twin Cam 110 – Granite.*	\$6,137.00

'14-'16 Twin-Cooled™ Touring models.

16200162	Twin Cam 103 – Black.*	\$5,126.00
16200163	Twin Cam 110 – Black.*	\$5,834.00
16200164	Twin Cam 110 – Granite.*	\$6,137.00

SCREAMIN' EAGLE® 419

LongBlock Program

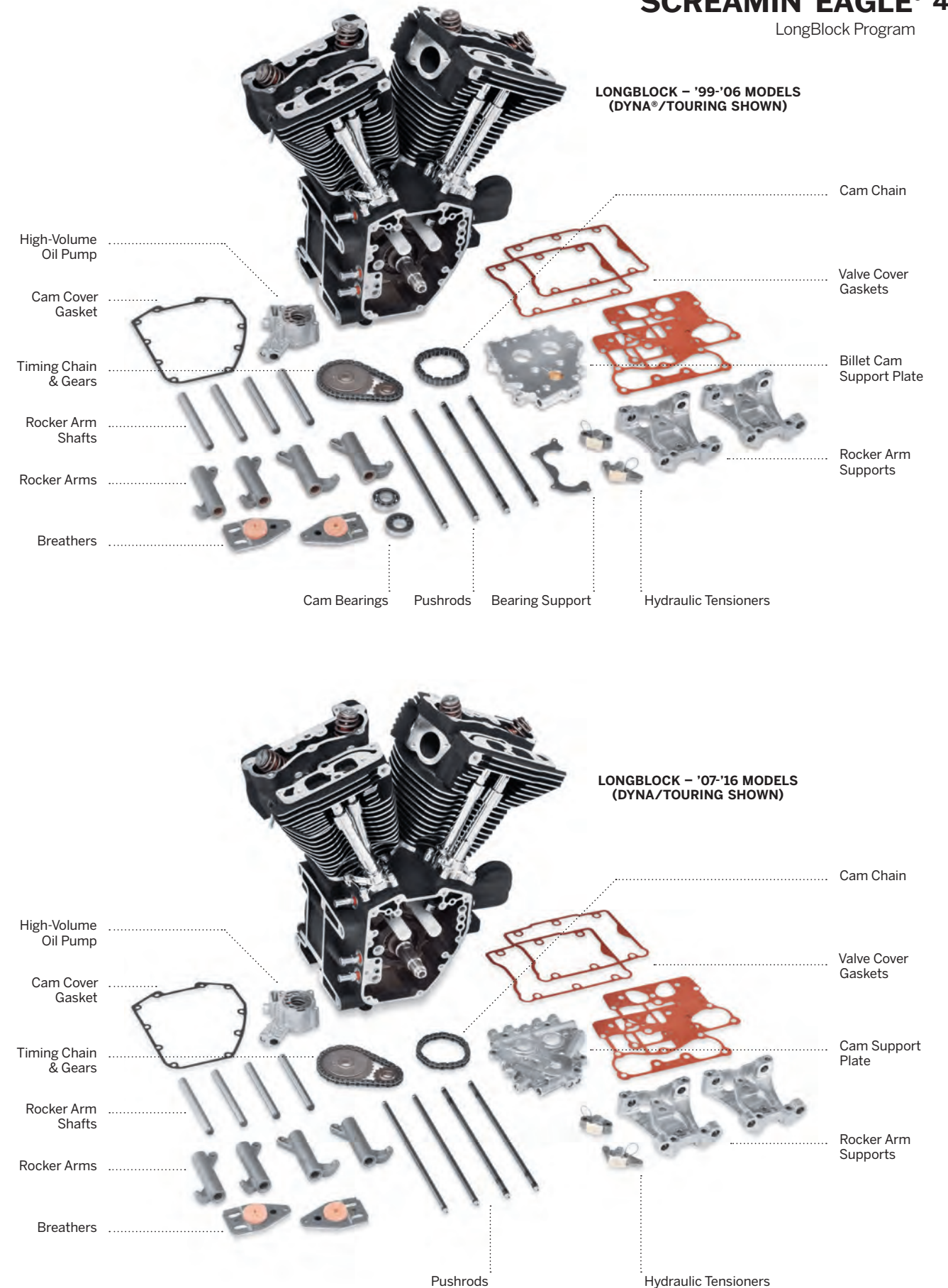

**LONGBLOCK – '99-'06 MODELS
(DYNA®/TOURING SHOWN)**

- High-Volume Oil Pump
- Cam Cover Gasket
- Timing Chain & Gears
- Rocker Arm Shafts
- Rocker Arms
- Breathers
- Cam Bearings
- Pushrods
- Bearing Support
- Hydraulic Tensioners
- Cam Chain
- Valve Cover Gaskets
- Billet Cam Support Plate
- Rocker Arm Supports

**LONGBLOCK – '07-'16 MODELS
(DYNA/TOURING SHOWN)**

- High-Volume Oil Pump
- Cam Cover Gasket
- Timing Chain & Gears
- Rocker Arm Shafts
- Rocker Arms
- Breathers
- Pushrods
- Hydraulic Tensioners
- Cam Chain
- Valve Cover Gaskets
- Cam Support Plate
- Rocker Arm Supports

Notice: The prices appearing in this catalog are the manufacturer's suggested retail prices. Actual retail prices may vary.

NOTE: All fasteners are included but not shown.

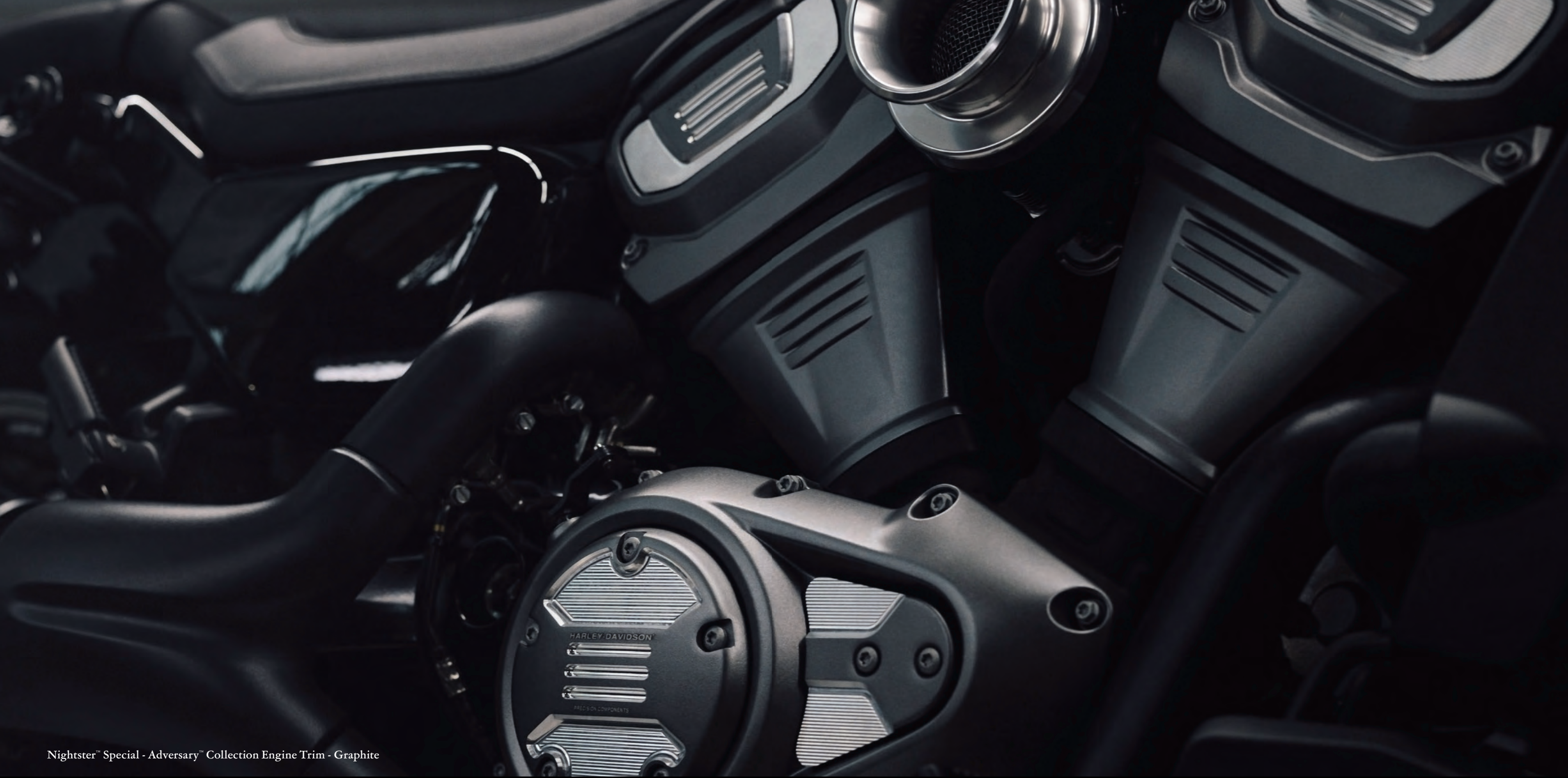

Nightster™ Special - Adversary™ Collection Engine Trim - Graphite

HARLEY-DAVIDSON®

ENGINE TRIM

Build a bike that fits your sense of style. To give your bike a clean and seamless appearance, select components from one of the Harley-Davidson® Engine Trim collections. You'll be one step closer to the look you've been dreaming about.

HARLEY-DAVIDSON® COLLECTIONS



ADVERSARY™ COLLECTION
Black and Orange
SEE PAGE 424 & 468



ADVERSARY COLLECTION
Graphite Highlighted
SEE PAGE 425 & 469



'66 COLLECTION
Black
SEE PAGE 426 & 470



HARLEY-DAVIDSON® MOTOR CO. COLLECTION
Black
SEE PAGE 430



HARLEY-DAVIDSON MOTOR CO. COLLECTION
Chrome
SEE PAGE 431



WILLIE G SKULL COLLECTION
Black
SEE PAGES 432 & 484 - 485



WILD ONE™ COLLECTION
Black
SEE PAGES 427 & 471



EMPIRE® COLLECTION
Gloss Black
SEE PAGE 428, 472 - 475



EMPIRE COLLECTION
Machine Cut
SEE PAGE 428, 472 - 473



WILLIE G SKULL COLLECTION
Chrome
SEE PAGES 433 & 486 - 487



END GAME COLLECTION
Black
SEE PAGES 478 - 479



DOMINION COLLECTION
Black or Bronze
SEE PAGES 480 - 482



EMPIRE COLLECTION
Chrome
SEE PAGE 428 & 476



KAHUNA™ COLLECTION
Black
SEE PAGES 429, 488



KAHUNA™ COLLECTION
Chrome
SEE PAGES 430, 489



DARK CUSTOM™ COLLECTION
Black or Chrome
SEE PAGE 434 & 435



AIRFLOW COLLECTION
Black or Chrome
SEE PAGE 436 & 490 - 491



LIVE TO RIDE COLLECTION
Chrome
SEE PAGE 437

424 ENGINE TRIM

Derby, Timer & Air Cleaner Covers

A. ADVERSARY™ COLLECTION — ANODIZED BLACK WITH ORANGE HIGHLIGHTS

A look to match your riding style – precise, refined and technical. Premium Adversary™ Collection accessories are crafted in forged billet aluminum with a durable dual-anodized black and orange finish for crisp contrast and colorful detail. The look is aggressive and performance driven. Step up to the next generation of customization.

- 1. 25701536** Derby Cover. **\$185.95**
Fits '16-later Touring and Trike, and '15-later FLHTCUL and FLHTKL models. Also fits '07-later Touring and Trike models equipped with Narrow-Profile Outer Primary Cover P/N 25700385 or 25700438.
- 2. 25701532** Derby Cover. **\$185.95**
Fits '18-later FLSB and '19-later Softail® models. Also fits '18 Softail models equipped with Narrow Profile Primary Cover P/Ns 25701077, 25700913, 25700937, 25700941, 25701039, 25701040 and 25701043.
- 3. 25600171** Timer Cover. **\$69.95**
Fits '17-later Milwaukee-Eight® engine-equipped models.
- 4. 25701164** Alternator Plug Cover. **\$89.95**
Fits '21-later Revolution® Max engine-equipped models.
- 5. 14101389** Clutch Medallion. **\$139.95**
Fits '21-later Revolution® Max engine-equipped models.
- 6. 14101393** Timer Medallion. **\$69.95**
Fits '21-later Revolution® Max engine-equipped models.
- 7. 14101385** Cam Sprocket Medallions. **\$89.95**
Fits '21-later Revolution® Max engine-equipped models.



A. ADVERSARY COLLECTION — DERBY COVER

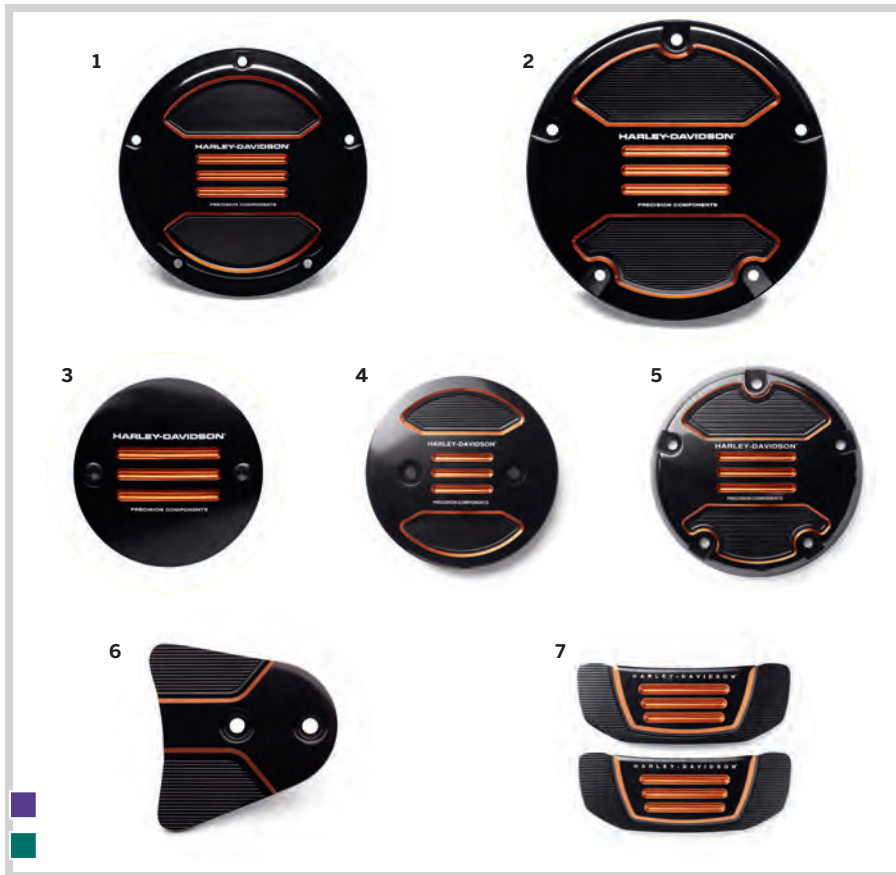

A. ADVERSARY COLLECTION — ANODIZED BLACK WITH ORANGE HIGHLIGHTS

ENGINE TRIM 425

Derby, Timer & Air Cleaner Covers

B. ADVERSARY™ COLLECTION — GRAPHITE WITH MACHINED HIGHLIGHTS

A look to match your riding style – precise, refined and technical. Premium Adversary™ Collection accessories are crafted in forged billet aluminum. The graphite finish with machined highlights reveal brilliant aluminum for crisp contrast and sharp detail. The look is aggressive and performance driven. Step up to the next generation of customization.

- 1. 25701537** Derby Cover. **\$170.95**
Fits '16-later Touring and Trike, and '15-later FLHTCUL and FLHTKL models. Also fits '07-later Touring and Trike models equipped with Narrow-Profile Outer Primary Cover P/N 25700385 or 25700438..
- 2. 25701533** Derby Cover. **\$170.95**
Fits '18-later FLSB and '19-later Softail® models. Also fits '18 Softail models equipped with Narrow Profile Primary Cover P/Ns 25701077, 25700913, 25700937, 25700941, 25701039, 25701040 and 25701043.
- 3. 25600172** Timer Cover. **\$64.95**
Fits '17-later Milwaukee-Eight® engine-equipped models.
- 4. 25701165** Alternator Plug Cover. **\$79.95**
Fits '21-later Revolution® Max engine-equipped models.
- 5. 14101390** Clutch Medallion. **\$124.95**
Fits '21-later Revolution® Max engine-equipped models.
- 6. 14101394** Timer Medallion. **\$69.95**
Fits '21-later Revolution® Max engine-equipped models.
- 7. 14101386** Cam Sprocket Medallions. **\$79.95**
Fits '21-later Revolution® Max engine-equipped models.



B. ADVERSARY COLLECTION — DERBY COVER

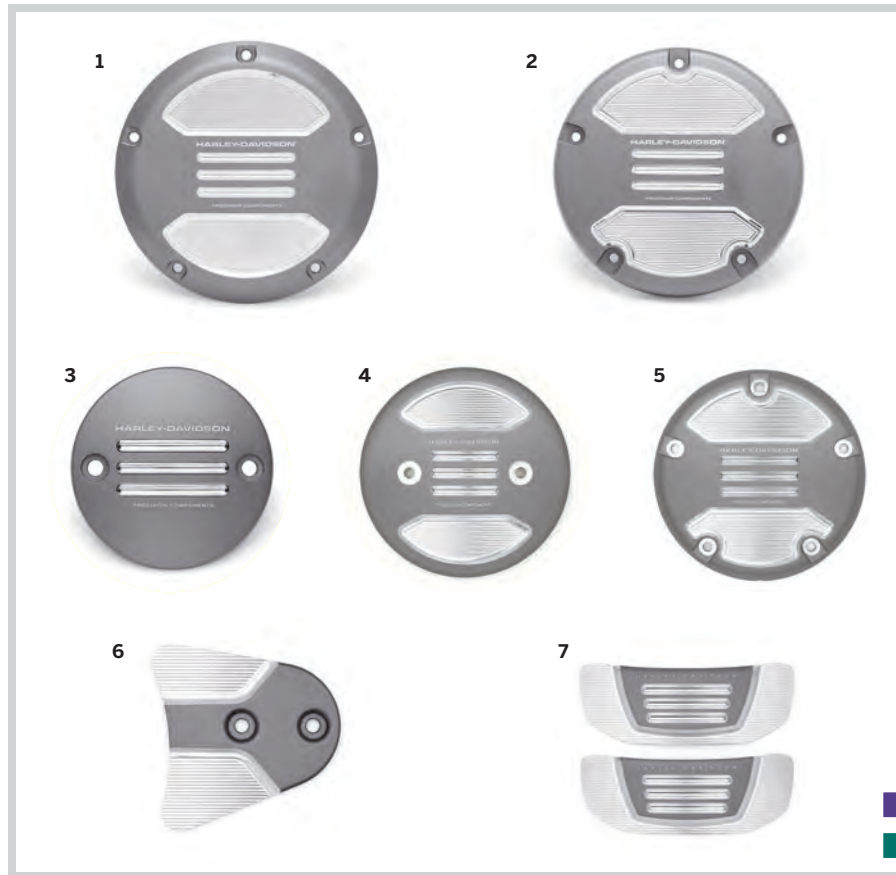

B. ADVERSARY COLLECTION — GRAPHITE WITH MACHINED HIGHLIGHTS

Model Family Fitment:

- V-ROD
- SPORTSTER
- DYNA
- SOFTAIL
- TOURING

Notice: The prices appearing in this catalog are the manufacturer's suggested retail prices. Actual retail prices may vary.

Notice: The prices appearing in this catalog are the manufacturer's suggested retail prices. Actual retail prices may vary.

426 ENGINE TRIM

Derby, Timer & Air Cleaner Covers

A. '66 COLLECTION

The look is timeless and authentic. The handcrafted style of the '66 Collection accessories combines a durable gloss black finish with brushed aluminum highlights and on most pieces a brass-colored medallion inspired by a classic Harley-Davidson® tank emblem. Here's an alternative to bright chrome or blacked out styles that will set your bike apart from the crowd.

- 1. 25701209** Derby Cover. **\$129.95**
Fits '18-later FLSB and '19-later Softail® models. Also fits '18 Softail models equipped with Narrow Profile Primary Cover P/Ns 25701077, 25700913, 25700937, 25700941, 25701039, 25701040 and 25701043
- 2. 25600156** Timer Cover. **\$59.95**
Fits '17-later Milwaukee-Eight® engine-equipped models.
- 3. 25701211** Alternator Plug Cover. **\$79.95**
Fits '21-later Revolution Max engine-equipped models.
- 4. 14101443** Clutch Medallion. **\$129.95**
Fits '21-later Revolution® Max engine-equipped models.
- 5. 14101445** Timer Medallion. **\$59.95**
Fits '21-later Revolution® Max engine-equipped models.
- 6. 14101615** Cam Sprocket Medallion. **\$79.95**
Fits '21-later Revolution® Max engine-equipped models.



A. '66 COLLECTION – DERBY COVER

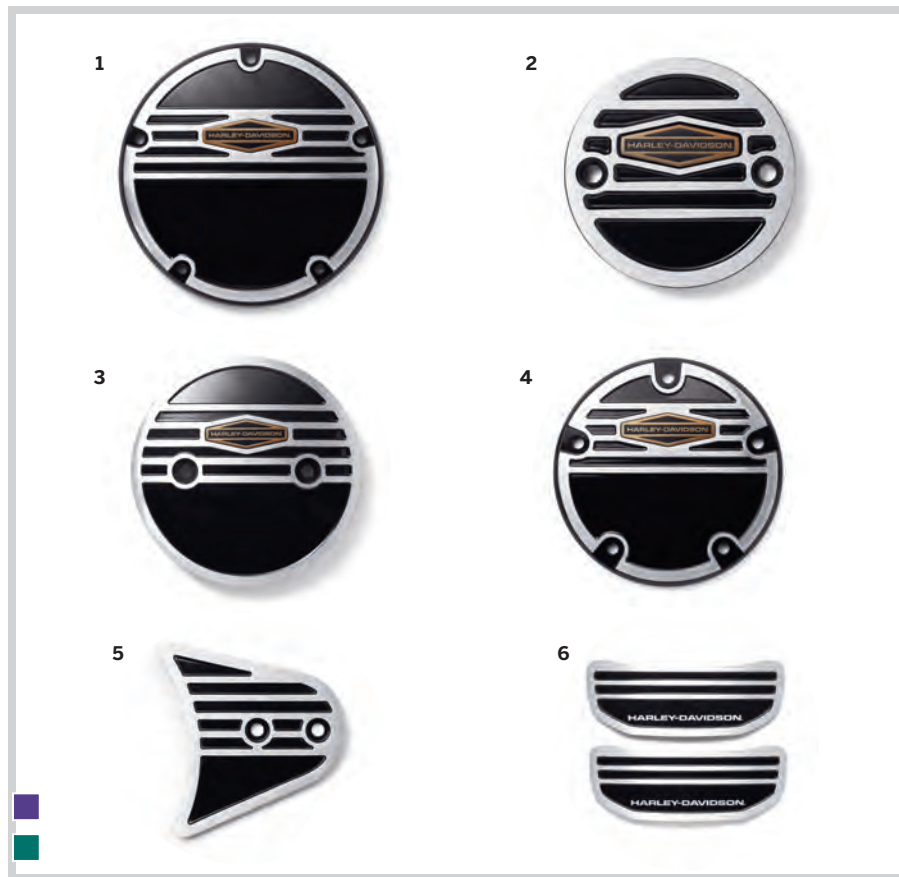

A. '66 COLLECTION

ENGINE TRIM 427

Derby, Timer & Air Cleaner Covers

B. WILD ONE™ COLLECTION

Add daring, raw-and-rugged style with durable billet aluminum Wild One™ Collection accessories. Each is finished in gloss black with bright, machined aluminum highlights, a variety of textures and exposed hardware to communicate power, speed, and performance.

- 1. 25701181** Alternator Plug Cover. **\$104.95**
Fits '21-later Revolution® Max engine-equipped models.
- 2. 14101402** Clutch Medallion. **\$132.95**
Fits '21-later Revolution Max engine-equipped models.
- 3. 14101398** Timer Medallion. **\$63.95**
Fits '17-later Milwaukee-Eight® engine-equipped models.
- 4. 14101557** Cam Sprocket Medallions. **\$104.95**
Fits '21-later Revolution® Max engine-equipped models.



B. WILD ONE COLLECTION – ALTERNATOR PLUG COVER.



B. WILD ONE COLLECTION

Model Family Fitment:

- V-ROD
- SPORTSTER
- DYNA
- SOFTAIL
- TOURING

Notice: The prices appearing in this catalog are the manufacturer's suggested retail prices. Actual retail prices may vary.

Notice: The prices appearing in this catalog are the manufacturer's suggested retail prices. Actual retail prices may vary.

428 ENGINE TRIM

Derby, Timer & Air Cleaner Covers

A. EMPIRE™ COLLECTION — GLOSS BLACK

Raise the stakes. Deep grooves add eye-catching depth and detail to the rich black anodized finish on this complete collection of hand and foot controls. Executed in durable cast and billet aluminum, the Black Empire™ Collection adds captivating custom detail that complements other black and machine cut accessories.

25701171 Derby Cover. **\$168.95**
Fits '16-later Touring and Trike and '15-later FLTHCUL and FLHTKL models. Also fits '07-later Touring and Trike models equipped with Narrow-Profile Outer Primary Cover P/N 25700385 or 25700438.

25701177 Derby Cover. **\$168.95**
Fits '18-later FLSB and '19-later Softail® models. Also fits '18 Softail models equipped with Narrow Profile Primary Cover P/N 25700900, 25700913, 25700937, 25700941, 25701039, 25701040 and 25701043.

25600148 Timer Cover. **\$63.95**
Fits '17-later Milwaukee-Eight® engine equipped models.

B. EMPIRE™ COLLECTION — BLACK MACHINE CUT

Raise the stakes. Milled highlights reveal gleaming billet aluminum below the rich black anodized surface, while deep grooves add eye-catching depth and detail to each component in this complete collection of hand and foot controls. Executed in durable cast and billet aluminum, the Black Machine Cut Empire™ Collection adds captivating custom detail that complements black or machine cut accessories.

25701173 Derby Cover. **\$183.95**
Fits '16-later Touring and Trike and '15-later FLTHCUL and FLHTKL models. Also fits '07-later Touring and Trike models equipped with Narrow-Profile Outer Primary Cover P/N 25700385 or 25700438.

25701179 Derby Cover. **\$183.95**
Fits '18-later FLSB and '19-later Softail® models. Also fits '18 Softail models equipped with Narrow Profile Primary Cover P/N 25700900, 25700913, 25700937, 25700941, 25701039, 25701040 and 25701043.

25600152 Timer Cover. **\$73.95**
Fits '17-later Milwaukee-Eight® engine equipped models

C. EMPIRE™ COLLECTION — CHROME

Raise the stakes. Brilliant chrome highlights the deep grooves that add eye-catching depth and detail to this complete collection of hand and foot controls. Executed in durable cast and billet aluminum, the Chrome Empire™ Collection adds captivating custom detail that complements other chrome accessories.

25701169 Derby Cover. **\$168.95**
Fits '16-later Touring and Trike and '15-later FLTHCUL and FLHTKL models. Also fits '07-later Touring and Trike models equipped with Narrow-Profile Outer Primary Cover P/N 25700385 or 25700438.

25701175 Derby Cover. **\$168.95**
Fits '18-later FLSB and '19-later Softail® models. Also fits '18 Softail models equipped with Narrow Profile Primary Cover P/N 25700900, 25700913, 25700937, 25700941, 25701039, 25701040 and 25701043.

25600150 Timer Cover. **\$63.95**
Fits '17-later Milwaukee-Eight® engine equipped models.



A. EMPIRE COLLECTION DERBY COVER — GLOSS BLACK



A. EMPIRE COLLECTION TIMER COVER — GLOSS BLACK



B. EMPIRE COLLECTION DERBY COVER — BLACK MACHINE CUT



B. EMPIRE COLLECTION TIMER COVER — BLACK MACHINE CUT



C. EMPIRE COLLECTION DERBY COVER — CHROME



C. EMPIRE COLLECTION TIMER COVER — CHROME



D. KAHUNA COLLECTION DERBY COVER — GLOSS BLACK



E. KAHUNA COLLECTION DERBY COVER — CHROME



D. KAHUNA COLLECTION — GLOSS BLACK



E. KAHUNA COLLECTION — CHROME

ENGINE TRIM 429

Derby, Timer & Air Cleaner Covers

D. KAHUNA™ COLLECTION — GLOSS BLACK

Understated but powerful, the Kahuna™ Collection's rich, gloss black surface is interrupted by a powerful raised bridge that draws the eye from leading to trailing edge. A red Bar & Shield logo adds the finishing touch.

1. 25700887 Derby Cover. **\$107.95**
Fits '16-later Touring and Trike and '15-later FLHTCUL and FLHTKL models. Also fits '07-later Touring and Trike models equipped with Narrow-Profile Outer Primary Cover P/N 25700385 or 25700438.

2. 25700988 Derby Cover. **\$107.95**
Fits '06-'17 Dyna®, '07-'18 Softail® (except FLSB) and '07-'15 Touring and Trike (except FLHTCUL and FLHTKL and '07-'15 Touring and Trike models equipped with Narrow-Profile Outer Primary Cover P/N 25700385 or 25700438).

3. 25600109 Timer Cover. **\$38.95**
Fits '17-later Milwaukee-Eight® engine-equipped models.

4. 25600108 Timer Cover. **\$38.95**
Fits '99-'17 Twin Cam-equipped models.

5. 61300928 Air Cleaner Trim **\$63.95**
Fits '17-later Touring and Trike models with Original Equipment air cleaner cover. Does not fit CVO™ models.

E. KAHUNA™ COLLECTION — CHROME

Understated but powerful, the Kahuna™ Collection's smooth, glass-like chrome surface is interrupted by a powerful raised bridge that draws the eye from leading to trailing edge. A red Bar & Shield logo adds the finishing touch.

1. 25700987 Derby Cover. **\$107.95**
Fits '16-later Touring and Trike and '15-later FLHTCUL and FLHTKL models. Also fits '07-later Touring and Trike models equipped with Narrow-Profile Outer Primary Cover P/N 25700385 or 25700438.

2. 25700888 Derby Cover. **\$107.95**
Fits '06-'17 Dyna®, '07-'18 Softail® (except FLSB) and '07-'15 Touring and Trike (except FLHTCUL and FLHTKL and '07-'15 Touring and Trike models equipped with Narrow-Profile Outer Primary Cover P/N 25700385 or 25700438).

3. 25600115 Timer Cover. **\$38.95**
Fits '17-later Milwaukee-Eight® engine-equipped models.

4. 25600114 Timer Cover. **\$38.95**
Fits '99-'17 Twin Cam-equipped models.

Model Family Fitment:

- V-ROD
- SPORTSTER
- DYNA
- SOFTAIL
- TOURING

Notice: The prices appearing in this catalog are the manufacturer's suggested retail prices. Actual retail prices may vary.

Notice: The prices appearing in this catalog are the manufacturer's suggested retail prices. Actual retail prices may vary.

430 ENGINE TRIM

Derby, Timer & Air Cleaner Covers

A. HARLEY-DAVIDSON® MOTOR CO. COLLECTION – GLOSS BLACK

An aggressive twist on a classic style. The Harley-Davidson® Motor Co. Collection personifies Harley style and features a rich gloss black surface, trimmed with deep-cut silver-filled lettering that surrounds a central groove. The clean design and the luxurious finish are the perfect match for blacked-out engines. Includes black zinc hardware.

- 1. 25701022** Derby Cover. **\$59.95**
Fits '16-later Touring and Trike and '15-later FLHTCUL and FLHTKL. Also fits '07-later Touring and Trike models equipped with Narrow-Profile Outer Primary Cover P/N 25700385 or 25700438.
- 1. 25701023** Derby Cover. **\$59.95**
Fits '18-later FLSB and '19-later Softail® models. Also fits '18 Softail models equipped with Narrow Profile Primary Cover P/N 25701077, 25700913, 25700937, 25700941, 25701039, 25701040 and 25701043.
- 1. 25701020** Derby Cover. **\$54.95**
Fits '99-'00 Evolution® 1340, '99-'17 Dyna®, '99-'18 Softail (except FLSB) and '99-'15 Touring and Trike models (except FLHTCUL, FLHTKL or '07-'15 Touring or Trike models with Narrow-Profile Outer Primary Cover P/N 25700385 or 25700438).
- 2. 25701021** Derby Cover. **\$54.95**
Fits '04-'22 XL and XR models.
- 3. 25600135** Timer Cover. **\$32.95**
Fits '17-later Milwaukee-Eight® engine-equipped models.
- 4. 25600133** Timer Cover. **\$32.95**
Fits '99-'17 Twin Cam equipped models.
- 5. 25600134** Timer Cover. **\$29.95**
Fits '04-'22 XL, XR and earlier models with horizontal holes on timer cover.
- 6. 61301005** Air Cleaner Trim. **\$54.95**
Fits '18-later FLDE, FLHC, FLHCS, FLSL, FXLR and '20-later FXST models with Original Equipment center bolt air cleaner cover.



A. HARLEY-DAVIDSON MOTOR CO. COLLECTION DERBY COVER – GLOSS BLACK

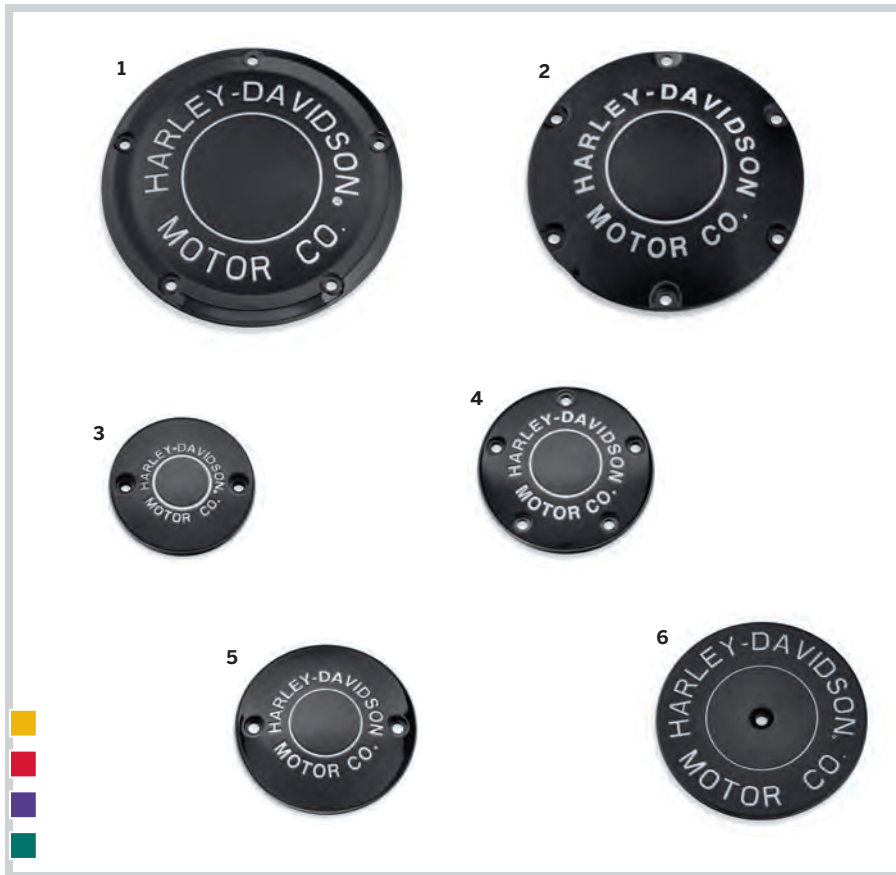

A. HARLEY-DAVIDSON MOTOR CO. COLLECTION – GLOSS BLACK

ENGINE TRIM 431

Derby, Timer & Air Cleaner Covers

B. HARLEY-DAVIDSON® MOTOR CO. COLLECTION – CHROME

This collection personifies Harley style. It had better, because we put our name on it—the Harley-Davidson® Motor Co. Collection.

- 1. 25700476** Derby Cover. **\$63.95**
Fits '16-later Touring and Trike, and '15-later FLHTCUL and FLHTKL models. Also fits '07-later Touring and Trike models equipped with Narrow-Profile Outer Primary Cover P/N 25700385 or 25700438.
- 1. 25700959** Derby Cover. **\$59.95**
Fits '18-later FLSB and '19-later Softail® models. Also fits '18-later Softail models equipped with Narrow Profile Primary Cover P/N 25701077, 25700913, 25700937, 25700941, 25701039, 25701040 and 25701043.
- 1. 25338-99B** Derby Cover. **\$54.95**
Fits '99-'00 Evolution® 1340, '99-'17 Dyna®, '99-'18 Softail (except FLSB) and '99-'15 Touring and Trike models (except FLHTCUL, FLHTKL or '07-'15 Touring or Trike models with Narrow-Profile Outer Primary Cover P/N 25700385 or 25700438).
- 2. 25130-04A** Derby Cover. **\$54.95**
Fits '04-'22 XL and XR models. Includes chrome-plated stainless steel mounting hardware.
- 3. 25600068** Timer Cover. **\$32.95**
Fits '17-later Milwaukee-Eight® engine-equipped models.
- 4. 32047-99A** Timer Cover. **\$32.95**
Fits '99-'17 Twin Cam-equipped models. Includes chrome-plated stainless steel mounting hardware.
- 5. 32668-98A** Timer Cover. **\$29.95**
Fits '04-'22 XL, XR and earlier models with horizontal holes on timer cover. Includes chrome-plated stainless steel mounting hardware.
- 6. 61300254** Air Cleaner Trim. **\$54.95**
Fits '16-'17 Softail (except FLSTFBS and FXSE) and '14-'16 Touring and Trike models with Original Equipment air cleaner cover. Does not fit CVO™ models.
- 7. 61300792** Air Cleaner Trim – Center Bolt. **\$54.95**
Fits '18-later FLDE, FLHC, FLHCS, FLSL, FXLR and '20-later FXST models with Original Equipment center bolt air cleaner cover.



B. HARLEY-DAVIDSON MOTOR CO. COLLECTION – CHROME

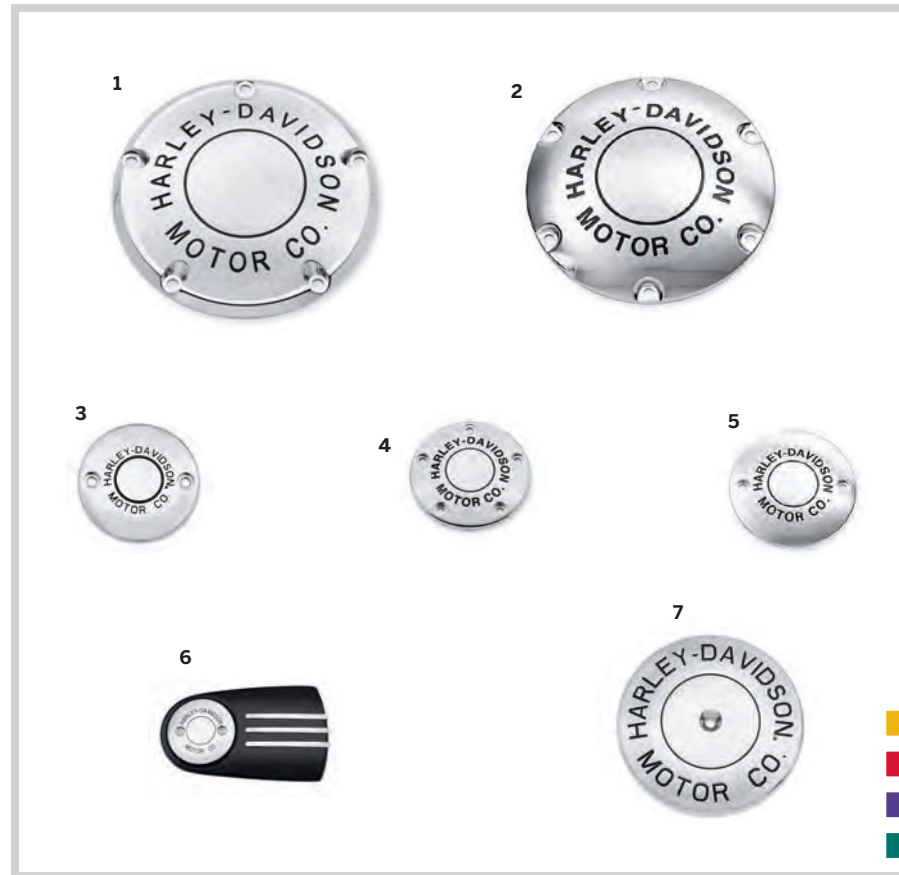

B. HARLEY-DAVIDSON MOTOR CO. COLLECTION – CHROME

Model Family Fitment:

- V-ROD
- SPORTSTER
- DYNA
- SOFTAIL
- TOURING

Notice: The prices appearing in this catalog are the manufacturer's suggested retail prices. Actual retail prices may vary.

Notice: The prices appearing in this catalog are the manufacturer's suggested retail prices. Actual retail prices may vary.

432 ENGINE TRIM

Derby, Timer & Air Cleaner Covers

A. WILLIE G SKULL COLLECTION – BLACK

Penned at the hand of Willie G the famous Skull Collection makes a shift to the dark side. Completely drenched in black, the raised skull and surrounding Harley-Davidson® Motorcycle script adds a subtle ominous touch to your ride. The finish easily coexists alongside gloss black or wrinkle black surfaces. The complete collection of components includes matching black hardware.

1. 25700740 Derby Cover. **\$74.95**
Fits '16-later Touring and Trike and '15-later FLHTCUL and FLHTKL models. Also fits '07-later Touring and Trike models equipped with Narrow-Profile Outer Primary Cover P/N 25700385 or 25700438.

1. 25700976 Derby Cover. **\$64.95**
Fits '18-later FLSB and '19-later Softail® models. Also fits '18 Softail models equipped with Narrow Profile Primary Cover P/N 25701077, 25700913, 25700937, 25700941, 25701039, 25701040 and 25701043.

1. 25700742 Derby Cover. **\$64.95**
Fits '99-'17 Dyna®, '00-'18 Softail (except FLSB) and '99-'15 Touring and Trike models (except '15 FLHTCUL and FLHTKL and '07-'15 Touring and Trike models equipped with Narrow-Profile Outer Primary Cover P/N 25700385 or 25700438). Installation on '06-'17 Dyna and '07-later Softail, and '07-'15 Touring and Trike models requires separate purchase of Gasket P/N 25416-99C.

2. 25700744 Derby Cover. **\$69.95**
Fits '04-'22 XL and XR models.

3. 25600085 Timer Cover. **\$32.95**
Fits '17-later Milwaukee-Eight® engine-equipped models.

4. 25600087 Timer Cover. **\$32.95**
Fits '99-'17 Twin Cam models.

5. 25600089 Timer Cover. **\$32.95**
Fits '04-'22 XL, XR and earlier models with horizontal holes on timer cover.

6. 29400345 Air Cleaner Trim. **\$54.95**
Fits '17-later Touring and Trike models with Original Equipment wedge shaped air cleaner cover.

7. 29400366 Air Cleaner Trim. **\$54.95**
Fits Evolution® 1340 models, '99-'08 Dyna, '00-'15 Softail (except FLS, FLSS, FLSTSB, and FXS) and '99-'13 Touring and Trike models equipped with oval-shaped Original Equipment air cleaner cover. Also fits models equipped with Screamin' Eagle® Round High-Flow Air Cleaner Kits with separate purchase of Rain Sock Kit P/N 28728-10 or Air Cleaner Trim Installation Kit P/N 12400158.

8. 29400339 Air Cleaner Trim. **\$54.95**
Fits '16-'17 Softail (except FLSTFBS and FXSE) and '14-'16 Touring and Trike models with Original Equipment air cleaner cover. Does not fit CVO™ models.

9. 29400341 Air Cleaner Trim. **\$47.95**
Fits '04-'22 XL models equipped with Original Equipment oval air cleaner cover.



A. WILLIE G SKULL COLLECTION DERBY COVER – BLACK



A. WILLIE G SKULL COLLECTION – BLACK



B. WILLIE G SKULL COLLECTION DERBY COVER – CHROME



B. WILLIE G SKULL COLLECTION – CHROME

ENGINE TRIM 433

Derby, Timer & Air Cleaner Covers

B. WILLIE G SKULL COLLECTION – CHROME

Add a little attitude to your ride. Styled to complement Harley-Davidson® Skull accessory items, the menacing raised skull with black-filled eyes leaps from a field of chrome. The surrounding Harley-Davidson® Motorcycles script is the perfect finishing touch. This complete collection of engine covers dresses your bike for a true custom look.

1. 25700469 Derby Cover. **\$74.95**
Fits '16-later Touring and Trike, and '15-later FLHTCUL and FLHTKL models. Also fits '07-later Touring and Trike models equipped with Narrow-Profile Outer Primary Cover P/N 25700385 or 25700438.

1. 25700958 Derby Cover. **\$74.95**
Fits '18-later FLSB and '19-later Softail® models. Also fits '18 Softail models equipped with Narrow Profile Primary Cover P/N 25701077, 25700913, 25700937, 25700941, 25701039, 25701040 and 25701043.

1. 25441-04A Derby Cover. **\$69.95**
Fits '99-'00 Evolution® 1340, '99-'17 Dyna®, '99-'18 Softail (except FLSB) and '99-'15 Touring and Trike models (except FLHTCUL, FLHTKL or '07-'15 Touring or Trike models with Narrow-Profile Outer Primary Cover P/N 25700385 or 25700438).

2. 25440-04A Derby Cover. **\$69.95**
Fits '04-'22 XL and XR models. Includes chrome-plated stainless steel mounting hardware.

3. 25600066 Timer Cover. **\$32.95**
Fits '17-later Milwaukee-Eight® engine-equipped models.

4. 32975-04A Timer Cover. **\$32.95**
Fits '99-'17 Twin Cam-equipped models. Includes chrome-plated stainless steel mounting hardware.

5. 32972-04A Timer Cover. **\$32.95**
Fits '04-'22 XL, XR and earlier models with horizontal holes on timer cover. Includes chrome-plated stainless steel mounting hardware.

6. 61300654 Air Cleaner Trim. **\$63.95**
Fits '17-later Touring and Trike models with Original Equipment air cleaner cover. Does not fit CVO™ models.

7. 29417-04 Air Cleaner Trim. **\$54.95**
Fits Evolution 1340 models, '99-'08 Dyna, '00-'15 Softail (except FLS, FLSS, FLSTSB and FXS) and '99-'13 Touring and Trike models with Original Equipment air cleaner cover. Also fits models equipped with Screamin' Eagle® Round High-Flow Air Cleaner Kits with separate purchase of Rain Sock Kit P/N 28728-10 or Air Cleaner Trim Installation Kit P/N 12400158.

8. 61300217 Air Cleaner Trim. **\$54.95**
Fits '16-'17 Softail (except FLSTFBS and FXSE) and '14-'16 Touring and Trike models with Original Equipment air cleaner cover. Does not fit CVO™ models.

9. 29416-04 Air Cleaner Trim. **\$48.95**
Fits '04-'22 XL models with Original Equipment oval air cleaner cover.

Model Family Fitment:

V-ROD
 SPORTSTER
 DYNA
 SOFTAIL
 TOURING

Notice: The prices appearing in this catalog are the manufacturer's suggested retail prices. Actual retail prices may vary.

Notice: The prices appearing in this catalog are the manufacturer's suggested retail prices. Actual retail prices may vary.

434 ENGINE TRIM

Derby, Timer & Air Cleaner Covers

A. DARK CUSTOM™ LOGO COLLECTION

The famous Harley-Davidson #1 logo with a sinister twist. Machined from billet aluminum, these covers feature domed surfaces that are polished and black anodized to a rich satin sheen, and then re-machined to expose the raw aluminum. The resulting high-contrast design complements both polished and painted engine finishes.

1. 25700434 Derby Cover – Billet. **\$160.95**
Fits '16-later Touring and Trike, and '15-later FLHTCUL and FLHTKL models. Also fits '07-later Touring and Trike models equipped with Narrow-Profile Outer Primary Cover P/N 25700385 or 25700438.

1. 25700960 Derby Cover. **\$155.95**
Fits '18-later FLSB and '19-later Softail® models. Also fits '18 Softail models equipped with Narrow Profile Primary Cover P/N 25701077, 25700913, 25700937, 25700941, 25701039, 25701040 and 25701043.

1. 25562-09 Derby Cover – Billet. **\$160.95**
Fits '99-'00 Evolution® 1340, '99-'17 Dyna®, '99-'18 Softail (except FLSB) and '99-'15 Touring and Trike models (except FLHTCUL, FLHTKL or '07-'15 Touring or Trike models with Narrow-Profile Outer Primary Cover P/N 25700385 or 25700438).

2. 25563-09 Derby Cover – Billet. **\$160.95**
Fits '04-'22 XL models.

3. 25600064 Timer Cover – Billet. **\$69.95**
Fits '17-later Milwaukee-Eight® engine-equipped models.

4. 32414-09 Timer Cover – Billet. **\$69.95**
Fits '99-'17 Twin Cam-equipped models.

5. 32415-09 Timer Cover – Billet. **\$69.95**
Fits '04-'22 XL, XR and earlier models with horizontal holes on timer cover.

6. 61300057 Air Cleaner Trim – Billet. **\$124.95**
Fits Evolution® 1340 models, '99-'08 Dyna, '00-'15 Softail (except FLS, FLSS, FLSTSB and FXS) and '99-'13 Touring and Trike models with Original Equipment air cleaner cover. Also fits models equipped with Screamin' Eagle® Round High-Flow Air Cleaner Kits with separate purchase of Rain Sock Kit P/N 28728-10 or Air Cleaner Trim Installation Kit P/N 12400158.



A. DARK CUSTOM LOGO COLLECTION DERBY COVER

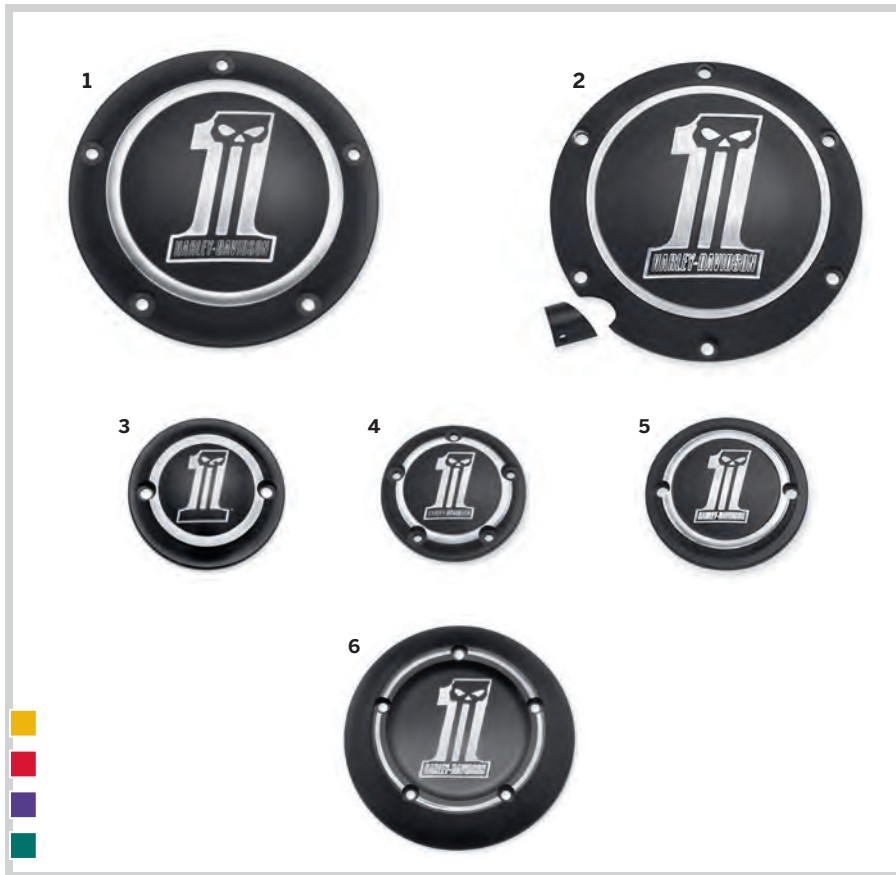

A. DARK CUSTOM LOGO COLLECTION

ENGINE TRIM 435

Derby, Timer & Air Cleaner Covers

B. NUMBER ONE SKULL COLLECTION

The sinister Harley-Davidson #1 Skull logo dresses for a night on the town. This complete die-cast aluminum collection has been polished and chrome-plated to a brilliant shine, then finished with a contrasting black-filled Dark Custom Skull logo. The black-filled race track stripe and recessed hardware pockets provide added depth and dimension. Includes chrome-plated mounting hardware.

1. 25700435 Derby Cover – Billet. **\$149.95**
Fits '16-later Touring and Trike, and '15-later FLHTCUL and FLHTKL models. Also fits '07-later Touring and Trike models equipped with Narrow-Profile Outer Primary Cover P/N 25700385 or 25700438.

1. 25331-10 Derby Cover. **\$79.95**
Fits '99-'00 Evolution® 1340, '99-'17 Dyna®, '99-'18 Softail® (except FLSB) and '99-'15 Touring and Trike models (except FLHTCUL, FLHTKL or '07-'15 Touring or Trike models with Narrow-Profile Outer Primary Cover P/N 25700385 or 25700438).

2. 25333-10 Derby Cover. **\$79.95**
Fits '04-'22 XL models.

3. 25600065 Timer Cover. **\$32.95**
Fits '17-later Milwaukee-Eight® engine-equipped models.

4. 32519-10 Timer Cover. **\$32.95**
Fits '99-'17 Twin Cam-equipped models.

5. 32520-10 Timer Cover. **\$32.95**
Fits '04-'22 XL, XR and earlier models with horizontal holes on timer cover.

6. 27956-10 Air Cleaner Trim. **\$58.95**
Fits Evolution® 1340 models, '99-'08 Dyna, '00-'15 Softail (except FLS, FLSS, FLSTSB and FXS) and '99-'13 Touring and Trike models with Original Equipment air cleaner cover. Also fits models equipped with Screamin' Eagle® Round High-Flow Air Cleaner Kits with separate purchase of Rain Sock Kit P/N 28728-10 or Air Cleaner Trim Installation Kit P/N 12400158.

7. 61300218 Air Cleaner Trim. **\$54.95**
Fits '16-'17 Softail (except FLSTFBS and FXSE) and '14-'16 Touring and Trike models with Original Equipment air cleaner cover. Does not fit CVO models.

8. 60826-11 Transmission Trim. **\$29.95**
Fits '11-'16 models equipped with 103CI Twin Cam engine option.



B. NUMBER ONE SKULL COLLECTION DERBY COVER

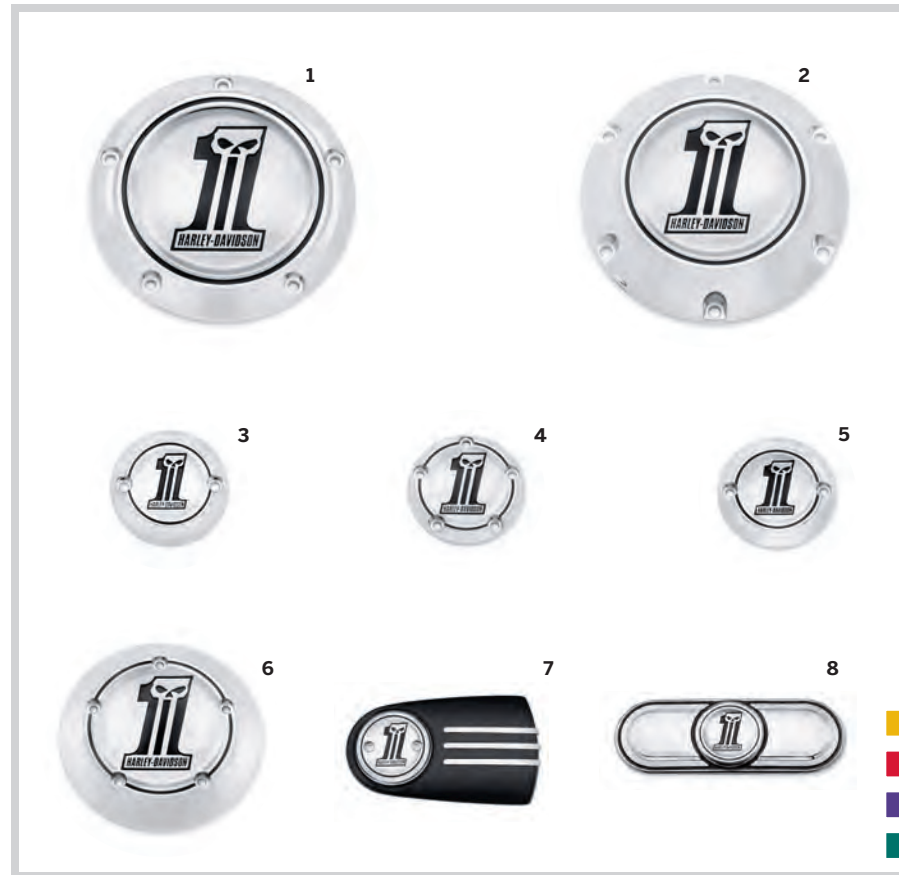

B. NUMBER ONE SKULL COLLECTION

Model Family Fitment:

V-ROD
 SPORTSTER
 DYNA
 SOFTAIL
 TOURING

Notice: The prices appearing in this catalog are the manufacturer's suggested retail prices. Actual retail prices may vary.

Notice: The prices appearing in this catalog are the manufacturer's suggested retail prices. Actual retail prices may vary.

436 ENGINE TRIM

Derby, Timer & Air Cleaner Covers

A. AIRFLOW COLLECTION

Shaped to cheat the wind. The polished and mirror-chromed Airflow Collection features a raised bridge with 3 laminar grooves that float over the recessed panels. The layered surfaces capture light and shadows, and frame the subtle black-filled Harley-Davidson signature. This complete collection sets the stage for your one-of-a-kind custom ride. Includes chrome-plated mounting hardware.

- 1. 25700505** Derby Cover. **\$84.95**
Fits '16-later Touring and Trike, and '15-later FLHTCUL and FLHTKL models. Also fits '07-later Touring and Trike models equipped with Narrow-Profile Outer Primary Cover P/N 25700385 or 25700438.
- 1. 25700969** Derby Cover. **\$84.95**
Fits '18-later FL5B and '19-later Softail® models. Also fits '18 Softail models equipped with Narrow Profile Primary Cover P/N 25701077, 25700913, 25700937, 25700941, 25701039, 25701040 and 25701043.
- 2. 25700504** Derby Cover. **\$84.95**
Fits '99-'17 Dyna®, '00-'18 Softail (except FL5B) and '99-'15 Touring and Trike models (except FLHTCUL, FLHTKL and '07-'15 Touring and Trike models equipped with Narrow-Profile Outer Primary Cover P/N 25700385 or 25700438). Installation on '06-later Dyna, '07-'18 Softail and '07-'15 Touring and Trike models require separate purchase of Gasket P/N 25416-99C.
- 3. 25700506** Derby Cover. **\$84.95**
Fits '04-'22 XL models.
- 4. 25600099** Timer Cover. **\$33.95**
Fits '17-later Milwaukee-Eight® engine-equipped models.
- 5. 25600046** Timer Cover. **\$33.95**
Fits '99-'17 Twin Cam models.
- 6. 25600047** Timer Cover. **\$33.95**
Fits '04-'22 XL models.
- 7. 61400323** Air Cleaner Trim. **\$64.95**
Fits Evolution® 1340 models, '99-'08 Dyna, '00-'15 Softail (except FLS, FL5S, FL5TSB and FXS) and '99-'13 Touring and Trike models equipped with oval-shaped Original Equipment air cleaner cover. Also fits models equipped with Screamin' Eagle® Round High-Flow Air Cleaner Kits with separate purchase of Rain Sock Kit P/N 28728-10 or Air Cleaner Trim Installation Kit P/N 12400158.
- 8. 61300542** Air Cleaner Trim. **\$64.95**
Fits '16-'17 Softail (except FL5TFBS and FXSE) and '14-'16 Touring and Trike models with Original Equipment Air Cleaner Cover. Does not fit CVO™ models.



A. AIRFLOW COLLECTION DERBY COVER

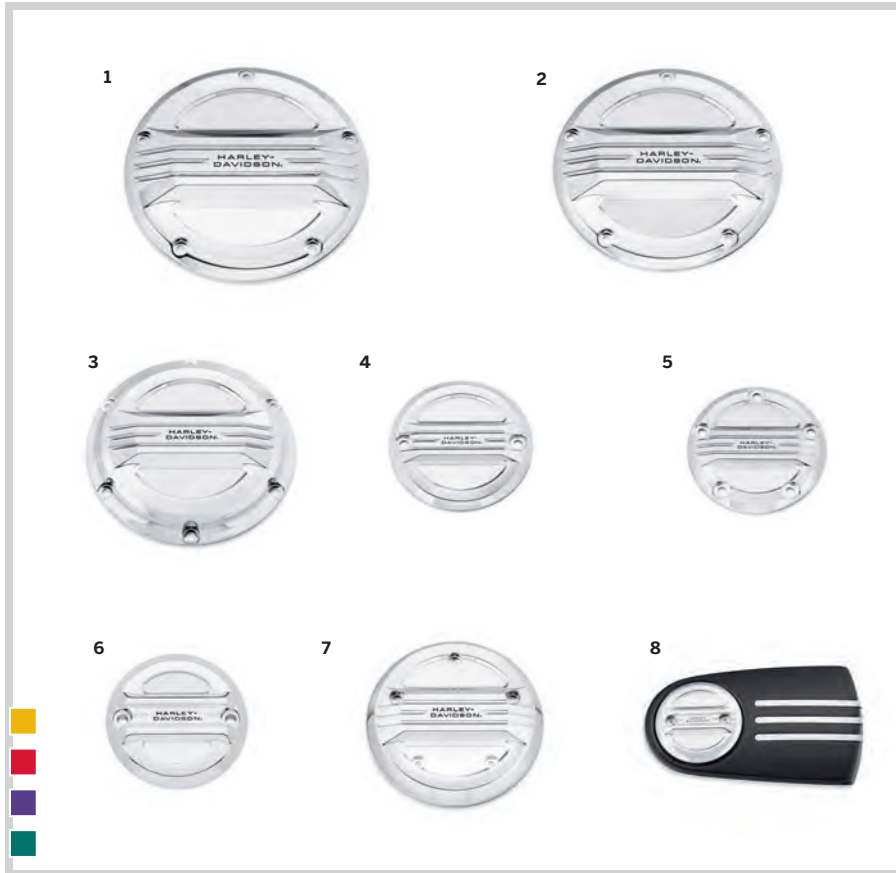

A. AIRFLOW COLLECTION

ENGINE TRIM 437

Derby, Timer & Air Cleaner Covers

C. HARLEY-DAVIDSON® LIVE TO RIDE COLLECTION – GOLD

Live to Ride, Ride to Live. It has become the motto of the Harley-Davidson nation, accompanying riders over millions of miles of travel. This collection is a tribute to that way of life.

- 1. 25700472** Derby Cover. **\$83.95**
Fits '16-later Touring and Trike, and '15-later FLHTCUL and FLHTKL models. Also fits '07-later Touring and Trike models equipped with Narrow-Profile Outer Primary Cover P/N 25700385 or 25700438.
- 1. 25700961** Derby Cover. **\$79.95**
Fits '18-later FL5B and '19-later Softail® models. Also fits '18 Softail models equipped with Narrow Profile Primary Cover P/N 25701077, 25700913, 25700937, 25700941, 25701039, 25701040 and 25701043.
- 1. 25340-99A** Derby Cover. **\$74.95**
Fits '99-'00 Evolution® 1340, '99-'17 Dyna®, '99-'18 Softail (except FL5B) and '99-'15 Touring and Trike models (except FLHTCUL, FLHTKL or '07-'15 Touring or Trike models with Narrow-Profile Outer Primary Cover P/N 25700385 or 25700438).
- 2. 25127-04A** Derby Cover. **\$74.95**
Fits '04-'22 XL and XR models. Includes chrome-plated stainless steel mounting hardware.
- 3. 25600067** Timer Cover. **\$41.95**
Fits '17-later Milwaukee-Eight® engine-equipped models.
- 4. 32689-99A** Timer Cover. **\$40.95**
Fits '99-'17 Twin Cam-equipped models. Includes chrome-plated stainless steel mounting hardware.
- 5. 32585-90T** Timer Cover. **\$41.95**
Fits models with vertical mounting holes.
- 32581-90TB** Timer Cover. (not shown) **\$41.95**
Fits '04-'22 XL, XR and earlier models with horizontal holes on timer cover. Includes chrome-plated stainless steel mounting hardware.
- 6. 61300656** Air Cleaner Trim. **\$73.95**
Fits '17-later Touring and Trike models with Original Equipment air cleaner cover. Does not fit CVO™ models.
- 7. 29328-99** Air Cleaner Trim. **\$54.95**
Fits Evolution 1340 models, '99-'08 Dyna, '00-'15 Softail (except FLS, FL5TSB and FXS) and '99-'13 Touring and Trike models with Original Equipment air cleaner cover. Also fits models equipped with Screamin' Eagle® Round High-Flow Air Cleaner Kits with separate purchase of Rain Sock Kit P/N 28728-10 or Air Cleaner Trim Installation Kit P/N 12400158.
- 8. 61400455** Air Cleaner Trim – Center Bolt. **\$64.95**
Fits '18-later FLDE, FLHC, FLHCS, FL5L, FXLR and '20-later FXST models with Original Equipment center bolt air cleaner cover.
- 9. 61400025** Transmission End Cover Trim. **\$35.95**
Fits '11-'16 Touring and Trike models equipped with 103CI Twin Cam engine option.



C. HARLEY-DAVIDSON LIVE TO RIDE DERBY COVER – GOLD



C. HARLEY-DAVIDSON LIVE TO RIDE COLLECTION – GOLD

Model Family Fitment:

- V-ROD
- SPORTSTER
- DYNA
- SOFTAIL
- TOURING

Notice: The prices appearing in this catalog are the manufacturer's suggested retail prices. Actual retail prices may vary.

Notice: The prices appearing in this catalog are the manufacturer's suggested retail prices. Actual retail prices may vary.

438 ENGINE TRIM

Milwaukee-Eight® Collections

A. GLOSS BLACK ENGINE COVER KIT – MILWAUKEE-EIGHT® POWERTRAIN

Upgrade your black and chrome Milwaukee-Eight® motor to the sinister look of gloss black. Manufactured from Original Equipment components, these richly finished engine covers start your bike on its journey to the dark side. Critical gasket surfaces are masked to provide a good sealing surface with the engine. The six-piece kit includes the primary cover, cam cover, upper rocker box covers, transmission side cover and transmission top cover. Rocker box lower housings, derby cover and timer cover are available separately.

Kit includes:

- Primary Cover
- Cam Cover
- Upper Rocker Box Covers (2)
- Transmission Side Cover with Insert
- Transmission Top Cover

92500059 Six Piece Engine Cover Kit. **\$765.95**
Fits '17-'20 Touring and Trike models.

B. MILWAUKEE-EIGHT ENGINE COVERS – GLOSS BLACK

These engine covers are the perfect start in converting your powertrain to an elegant tuxedo black look. Manufactured from Original Equipment components to ensure a perfect fit, these covers are coated with temperature-resistant paint to ensure a long-lasting finish, and critical surfaces are masked to provide good gasket seal. Complete the look with matching primary covers, rocker housings, rocker covers, cam covers and transmission covers (sold separately).

25700491 Primary Cover. **\$295.95**
Fits '17-later Touring and Trike models.

25700750 Primary Cover. **\$295.95**
Fits '18 Softail® models (except FLSB, FXBB, FXBBS, , FXLR, FXLRS, and FXLRST).

25700913 Narrow-Profile Primary Cover. **\$295.95**
Fits '18-later Softail models (except FXST, FXBB, FXBBS, FXLR, FXLRS and FXLRST). '18 models (except FLSB) require separate purchase of Softail Narrow Derby Cover and required gaskets.

25700467 Cam Cover. **\$159.95**
Fits '18-later Softail and '17-later Touring and Trike models.

25700520 Rocker Box Cover – Upper. **\$137.95**
Fits '18-later Softail and '17-later Touring and Trike models (2 required).

25700638 Rocker Box Cover – Lower. **\$151.95**
Fits '18-later Softail and '17-later Touring and Trike models (2 required).

25800055 Transmission Side Cover. **\$87.95**
Fits '17-'20 Touring and Trike models.

25800098 Transmission Side Cover. **\$87.95**
Fits '18-later Softail and '21-later Touring and Trike models

34800031 Transmission Top Cover. **\$87.95**
Fits '18-later Softail and '17-later Touring and Trike models. '18-later Softail models require separate purchase of gasket P/N 25700453.

25700477 Derby Cover. **\$53.95**
Fits '16-later Touring and Trike, and '15-later FLHTCUL and FLHTKL models. Also fits '07-later Touring and Trike models equipped with Narrow-Profile Outer Primary Cover P/N 25700385 or 25700438.

25700971 Derby Cover. **\$59.95**
Fits '18-later FLSB and '19-later Softail models. Also fits '18 Softail models equipped with Narrow Profile Primary Cover P/Ns 25701077, 25700913, 25700937, 25700941, 25701039, 25701040 and 25701043.

25600098 Timer Cover. **\$29.95**
Fits '17-later Milwaukee-Eight engine-equipped models.

NOTE: Removing and installing engine covers may require purchase of new gaskets. See dealer for information.

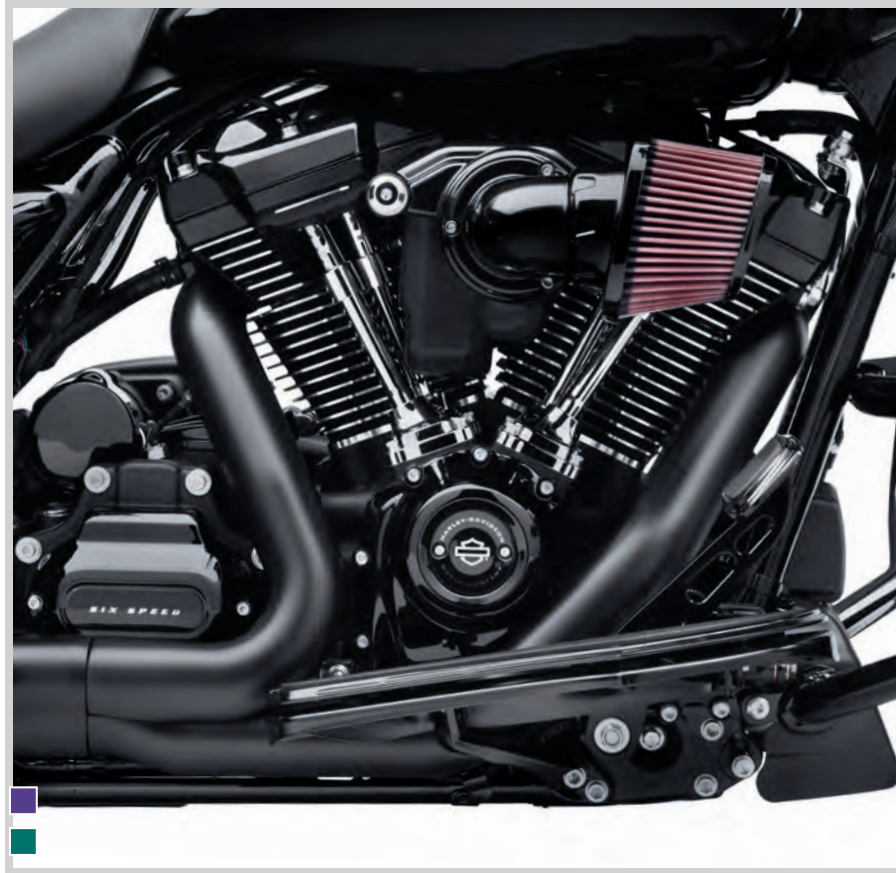

A. GLOSS BLACK ENGINE COVER KIT – MILWAUKEE-EIGHT POWERTRAIN



B. MILWAUKEE-EIGHT ENGINE COVERS – GLOSS BLACK

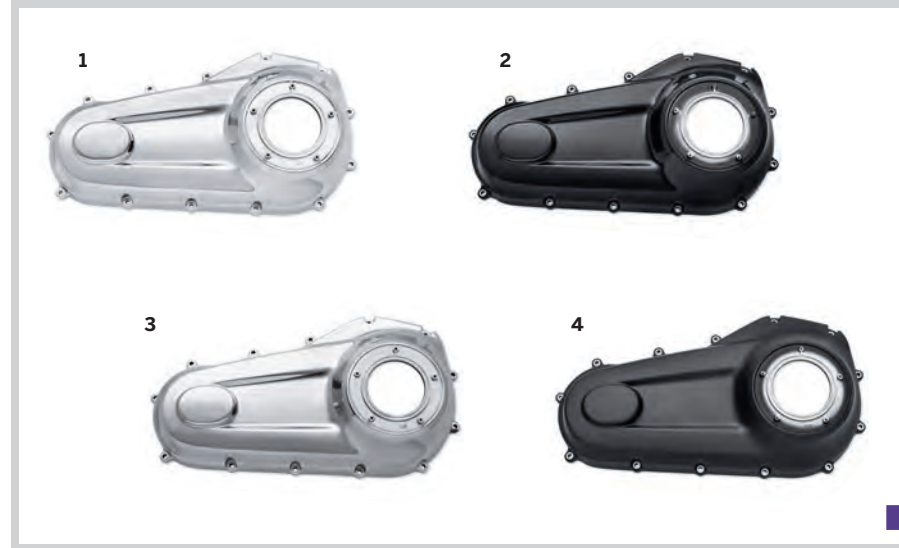

C. NARROW-PROFILE PRIMARY COVERS – FORWARD CONTROLS



D. OE STYLE NARROW-PROFILE DERBY COVERS – '19-LATER SOFTAIL



E. 120TH ANNIVERSARY DECORATIVE COVERS

ENGINE TRIM 439

Engine Covers – Milwaukee-Eight®

C. NARROW-PROFILE PRIMARY COVERS – FORWARD CONTROLS

Shaped to slim the bike's left side profile, this Narrow-Profile Primary Cover provide short-limbed riders a straight leg path to the pavement. Original Equipment on '19-later Softail® models.

Fits '18-later Softail models (except FXST, FXBB, FXBBS, FXLR, FXLRS and FXLRST). '18 models (except FLSB) require separate purchase of Softail Narrow Derby Cover and required gaskets.

1. 25701077	Chrome.	\$383.95
2. 25700913	Gloss Black.	\$295.95
3. 25701039	Polished.	\$273.95
4. 25701043	Wrinkle Black.	\$295.95

Also available:

Fits '18-later FXBB, FXBBS, FXLRS, FXLRST, FXLR and FXST models. '18 models require separate purchase of Softail Derby Cover and required gaskets.

25700937	Chrome.	\$295.95
25700941	Wrinkle Black.	\$295.95

D. OE STYLE NARROW-PROFILE DERBY COVERS – '19-LATER SOFTAIL®

Fits '18-later FLSB and '19-later Softail models. Also fits '18 Softail models equipped with Narrow Profile Primary Cover P/Ns 25701077, 25700913, 25700937, 25700941, 25701039, 25701040 and 25701043.

1. 25700934	Polished.	\$55.95
2. 25700970	Black Denim.	\$59.95
3. 25700971	Gloss Black.	\$59.95
4. 25700972	Wrinkle Black.	\$59.95
5. 25700968	Black Fin.	\$47.95

E. 120TH ANNIVERSARY DECORATIVE COVERS

Celebrate 120 years of Harley-Davidson pride and craftsmanship. This easy-to-install accessory collection is also standard equipment on the limited-edition Harley-Davidson® 120th Anniversary models. Handsome red fade finish with subtle gold and black accents.

1. 61301326 Air Cleaner Trim. **\$49.95**

Fits '17-later Touring and Trike models with Original Equipment wedge shaped air cleaner cover. Does not fit CVO™ models.

2. 61301327 Air Cleaner Trim. **\$49.95**

Fits '18-later Softail and '17-later Touring and Trike models equipped with Ventilator Air Cleaner P/N 29400298 or 29400299. Also fits '18-later Softail® models with 114CI engines and '17-later CVO touring models with Original Equipment Ventilator Air Cleaner with separate purchase of Air Filter P/N 29400293.

3. 25600176 Timer Cover. **\$49.95**
Fits '17-later Milwaukee-Eight engine-equipped models.

Model Family Fitment:

- V-ROD
- SPORTSTER
- DYNA
- SOFTAIL
- TOURING

Notice: The prices appearing in this catalog are the manufacturer's suggested retail prices. Actual retail prices may vary.

Notice: The prices appearing in this catalog are the manufacturer's suggested retail prices. Actual retail prices may vary.

440 ENGINE TRIM

Derby, Timer & Air Cleaner Covers

A. CLASSIC CHROME COVERS

From the design philosophy of less is more, we bring you this collection of basic chrome accessories, which provides a clean, custom look that is guaranteed to turn heads.

1. 25700388 Derby Cover. **\$71.95**
Fits '16-later Touring and Trike, and '15-later FLHTCUL and FLHTKL models. Also fits '07-later Touring and Trike models equipped with Narrow-Profile Outer Primary Cover P/N 25700385 or 25700438.

1. 60766-06 Derby Cover. (not shown) **\$73.95**
Fits '06-'17 Dyna® and '07-'18 Softail® (except FLST), '07-'15 Touring and Trike models (except FLHTCUL, FLHTKL or '07-'15 Touring or Trike models equipped with Narrow-Profile Outer Primary Cover P/N 25700385 or 25700438). Does not fit with passenger footboards in the "medium" or "low" position when flipped up.

2. 34760-04 Derby Cover. **\$74.95**
Fits '04-'22 XL models.

3. 32584-88TA Timer Cover. **\$29.95**
Fits '04-'22 XL, XR and earlier models with horizontal lines on timer cover. Includes chrome-plated stainless steel mounting hardware.

4. 32679-99A Timer Cover. **\$29.95**
Fits Twin Cam-equipped models. Includes chrome-plated stainless steel mounting hardware.

5. 25600097 Timer Cover. **\$29.95**
Fits '17-later Milwaukee-Eight® engine-equipped models.

34761-04A Chain Inspection Cover. (not shown) **\$28.95**
Fits '04-'22 XL models.

6. 60529-90A Chain Inspection Cover. **\$95.95**
Fits '91-'05 Dyna models (except FXDWG).

7. 60572-86 Chain Inspection Cover. **\$73.95**
Fits '93-'05 FXDWG and '86-'06 FLST, FXST and FXSTS models.

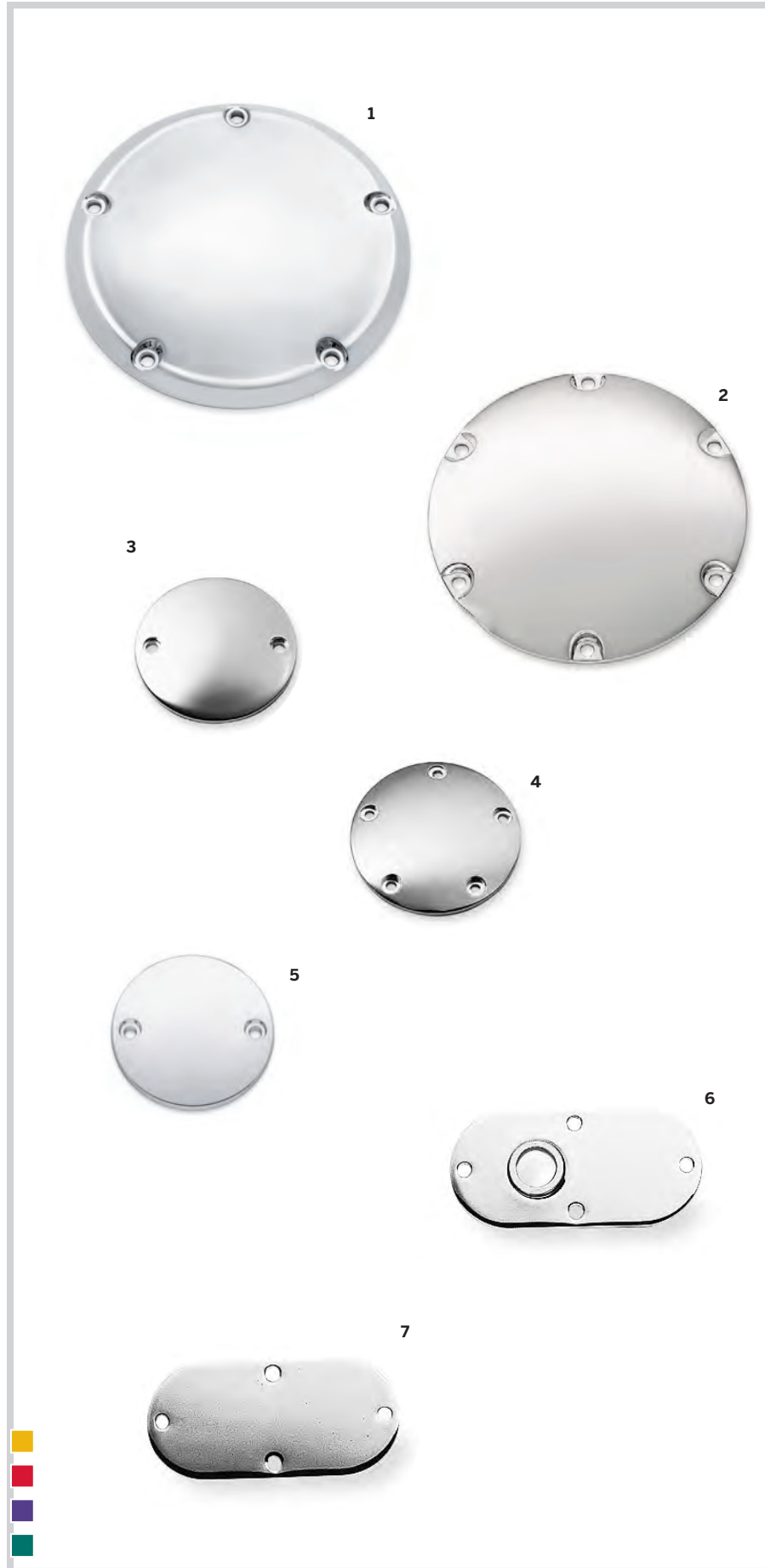

A. CLASSIC CHROME COVERS



B. BLACK FIN COLLECTION

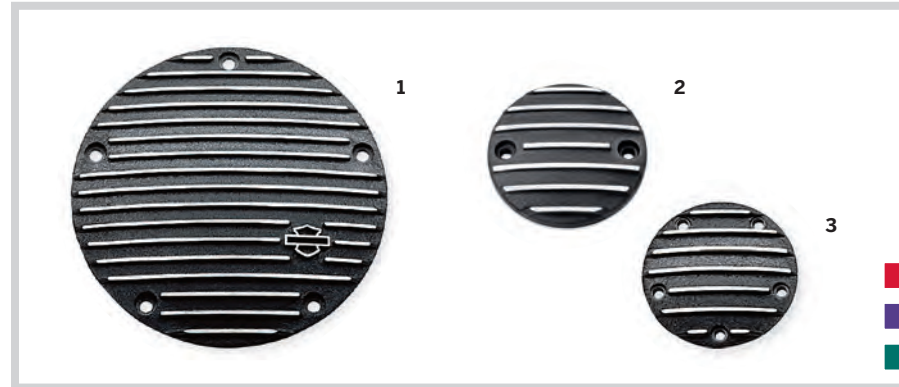

B. BLACK FIN COLLECTION



C. BLACK DERBY COVERS



C. BLACK DERBY COVERS

ENGINE TRIM 441

Engine Covers – Milwaukee-Eight®

B. BLACK FIN COLLECTION

Finish the sinister black look of your motorcycle with the Black Fin Collection from Harley-Davidson. The raised horizontal lines on these die-cast covers echo the traditional cylinder fin look, and the wrinkle black finish is a perfect match for the blacked-out primary, cam cover and Finned Headbolt Bridge Kit.

1. 25454-01 Derby Cover. **\$47.95**
Fits '99-'00 Evolution® 1340, '99-'17 Dyna®, '99-'18 Softail® (except FLST) and '99-'15 Touring and Trike models (except FLHTCUL, FLHTKL or '07-'15 Touring or Trike models with Narrow-Profile Outer Primary Cover P/N 25700385 or 25700438).

2. 25600142 Timer Cover. **\$29.95**
Fits '17-later Milwaukee-Eight® engine-equipped models.

3. 32677-01 Timer Cover. **\$29.95**
Fits '99-'17 Twin Cam-equipped models.

C. BLACK DERBY COVERS

Available in your choice of wrinkle black or gloss black finish, these simple Derby Covers add a finishing touch to your blacked-out engine.

Fits '06-'17 Dyna and '07-'18 Softail (except FLST), and '07-'15 Touring and Trike models (except FLHTCUL, FLHTKL or '07-'15 Touring or Trike models equipped with Narrow-Profile Outer Primary P/N 25700385 or 25700438). Does not fit with passenger footboards in the "medium" or "low" position when flipped up.

60713-07 Wrinkle Black. **\$48.95**

25700020 Gloss Black. **\$54.95**

Fits '16-later Touring and Trike, and '15-later FLHTCUL and FLHTKL models. Also fits '07-later Touring and Trike models equipped with Narrow-Profile Outer Primary Cover P/N 25700385 or 25700438.

25700477 Gloss Black. **\$53.95**

Fits '04-'22 XL models.

34790-05 Wrinkle Black. **\$43.95**

Model Family Fitment:

V-ROD SPORTSTER ■ DYNA

SOFTAIL TOURING

Notice: The prices appearing in this catalog are the manufacturer's suggested retail prices. Actual retail prices may vary.

Notice: The prices appearing in this catalog are the manufacturer's suggested retail prices. Actual retail prices may vary.

442 ENGINE TRIM

Engine Covers – Milwaukee-Eight®

A. MILWAUKEE-EIGHT® ENGINE ACCENT KIT

Get your high-performance engine noticed with this new Milwaukee-Eight® Engine Accent Kit. The kit includes tappet covers, lower rocker box covers, and pushrod collars that add dramatic contrasting color to the powertrain. A great way to detail out an engine upgraded with a Screamin' Eagle® Stage Kit.

Fits '17-later models equipped with Milwaukee-Eight® engine..

92500122	Orange.	\$499.95
92500121	Red.	\$499.95



A. MILWAUKEE-EIGHT ENGINE ACCENT KIT – ORANGE



A. MILWAUKEE-EIGHT ENGINE ACCENT KIT – RED

B. INNER PRIMARY COVER TRIM

Get the look of a custom inner primary cover without tearing apart the drive train. Designed to wrap the top surface of the wrinkle-painted inner primary cover, this die-cast shell provides a beefy finished look to the engine cases. Easy to install, the cover is secured with the outer primary hardware, and held in place at multiple points for quiet operation. Available in your choice of brilliant chrome or gloss black finish, the complete kit includes matching mounting hardware.

Fits '17-later Touring and Trike models.

25700631	Chrome.	\$170.95
25700654	Gloss Black.	\$170.95

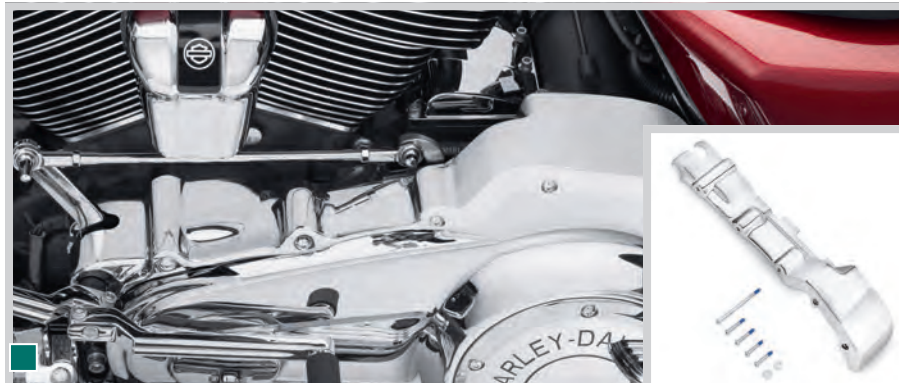

B. INNER PRIMARY COVER TRIM – CHROME

C. STARTER MOTOR END COVER

It's the details that make the complete custom bike. This starter end cover dresses the end of the starter motor for a clean look. Available in mirror chrome or rich gloss black to match your customizing style.

Fits '17-later Touring and Trike models. Does not fit models equipped with CoolFlow™ Fan P/N 26800120, 26800121 or 26800128.

31400088	Chrome.	\$84.95
31400090	Gloss Black.	\$84.95



B. INNER PRIMARY COVER TRIM – GLOSS BLACK



C. STARTER MOTOR END COVER – CHROME



C. STARTER MOTOR END COVER – GLOSS BLACK



D. PUSHROD COVER KIT – GLOSS BLACK (SHOWN WITH TAPPET COVERS – GLOSS BLACK)



D. PUSHROD COVER KIT – GLOSS BLACK



E. TAPPET COVERS – GLOSS BLACK



F. FRONT ENGINE MOUNT STABILIZER LINK



G. FINNED SPARK PLUG COVERS



ENGINE TRIM 443

Engine Covers – Milwaukee-Eight®

D. PUSHROD COVER KIT – GLOSS BLACK

Complete the sinister look. These covers replace existing chrome covers to give your bike a blacked-out appearance down to the smallest detail. Pushrod covers are finished in gloss black and the kit includes the four bottom cover tubes, four upper clips and four center collars. Cover Kit can be installed on engines already equipped with Adjustable Pushrods or can be installed by removing rocker box covers, rocker arms and non-adjustable pushrods. Consult your dealer or service manual for installation.

17900081	\$110.95
-----------------	-----------------

Fits '17-later Milwaukee-Eight® engine-equipped models. Requires prior installation of Adjustable Pushrods or removal of rocker box covers, rocker arms and fixed-length pushrods.

E. TAPPET COVERS – GLOSS BLACK

Complete your Twin Cam engine's conversion to a total blacked-out look. These gloss black tappet blocks replace the stock bright-finished components for a sinister appearance, and are manufactured from Original Equipment components for perfect fit and function. Gasket surface has been masked to ensure good oil seal. Kit comes complete with a front and rear cylinder lifter covers and two base gaskets.

25700890	\$87.95
-----------------	----------------

Fits '17-later Milwaukee-Eight engine-equipped models. Sold in pairs.

F. FRONT ENGINE MOUNT STABILIZER LINK

Add a custom style to the front end with this brilliant chrome-plated Engine Mount Stabilizer Link. This custom heim joint assembly complements the chrome Billet Front Engine Mount Bracket P/N 16205-10. Kit includes chrome mounting hardware.

Fits '09-later Touring and Trike models.

16213-10	Chrome.	\$59.95
16400055	Black.	\$48.95

G. FINNED SPARK PLUG COVERS

Complete the finned look from the base of the cylinder all the way to the rocker box. These aluminum Finned Spark Plug Covers fill the spark plug pockets and complete the horizontal fin look across the top of the left-hand side of the engine. Firmly held in place by spring clips, these easy-to-install finned covers slip into position and do not require removal of the spark plugs for installation. Sold in pairs.

Fits '17-later Milwaukee-Eight engines.

25800061	Black.	\$64.95
-----------------	--------	----------------

Model Family Fitment:

 V-ROD	 SPORTSTER	 DYNA
 SOFTAIL	 TOURING	

Notice: The prices appearing in this catalog are the manufacturer's suggested retail prices. Actual retail prices may vary.

Notice: The prices appearing in this catalog are the manufacturer's suggested retail prices. Actual retail prices may vary.

444 ENGINE TRIM

Engine Covers – Twin Cam

A. TWIN CAM ENGINE COVERS – GLOSS BLACK

These engine covers are the perfect start in converting your powertrain to an elegant tuxedo black look. Manufactured from Original Equipment components to ensure a perfect fit, these covers are masked and coated with temperature-resistant paint to ensure a long-lasting finish. Complete the look with matching primary covers, rocker housings, rocker covers, cam covers and transmission covers (sold separately).

60876-11A Primary Cover. **\$295.95**
Fits '07-'17 Softail® models. Also fits '06-'17 FLD and Dyna® models equipped with factory forward controls. Will not fit with Accessory Forward Controls.

60886-11A Primary Cover. **\$295.95**
Fits '07-'15 Touring and Trike models (except FLHTCUL and FLHTKL).

25700438 Narrow Primary Cover. **\$295.95**
Fits '07-'16 Touring and Trike models. Installation requires separate purchase of narrow derby cover, derby cover gasket and primary gasket. Chrome is Original Equipment on '15-'16 FLHTCUL and FLHTKL and '16 Touring and Trike models.

17707-11 Rocker Box Cover. **\$97.95**
Fits '99-'17 Dyna, '00-'17 Softail, and '99-'16 Touring and Trike models (2 required).

17709-11 Rocker Box Lower Housing. **\$97.95**
Fits '99-'17 Dyna, '00-'17 Softail, and '99-'16 Touring and Trike models (2 required).

37198-11 Cam Cover. **\$154.95**
Fits '01-'17 Dyna, Softail and '01-'16 Touring and Trike models (except '01 EFI Touring).

37193-11 Transmission Side Cover. **\$107.95**
Fits '06-'17 Dyna, and '07-'17 Softail (except FLSS, FLSTFBS, FXCW, FXCWC, FXSB and FXSE), and '07-'16 Touring and Trike models. Does not fit models equipped with a hydraulic clutch.

25700180 Transmission Side Cover. **\$98.95**
Fits '13-'16 Touring and Trike models equipped with hydraulic clutch.

37195-11 Transmission Top Cover. **\$107.95**
Fits '06-'17 Dyna and '07-later Softail and '07-'16 Touring and Trike models.

25700020 Derby Cover. **\$54.95**
Fits '06-'17 Dyna and '07-'18 Softail (except FLSS) and '07-'15 Touring and Trike models (except FLHTCUL, FLHTKL or '07-'15 Touring or Trike models equipped with Narrow-Profile Outer Primary Cover P/N 25700385 or 25700438).

25700477 Derby Cover. **\$53.95**
Fits '16-later Touring and Trike, and '15-later FLHTCUL and FLHTKL models. Also fits '07-later Touring and Trike models equipped with Narrow-Profile Outer Primary Cover P/N 25700385 or 25700438.

NOTE: Removing and installing engine covers may require purchase of new gaskets. See dealer for information.



A. TWIN CAM ENGINE COVERS – GLOSS BLACK



A. TWIN CAM ENGINE COVERS – GLOSS BLACK



B. TWIN CAM ENGINE COVERS – WRINKLE BLACK



B. TWIN CAM ENGINE COVERS – WRINKLE BLACK

ENGINE TRIM 445

Engine Covers – Twin Cam

B. TWIN CAM ENGINE COVERS – WRINKLE BLACK

These black powder-coated engine covers are the perfect start in converting your powertrain to a striking wrinkle black look. Manufactured from Original Equipment components, these covers are masked and painted on the factory production paint line to ensure a matching wrinkle black or texture black finish and a perfect fit. Complete the blacked-out look with matching primary covers, rocker housings, rocker covers, cam covers and transmission covers (sold separately).

60758-06A Primary Cover. **\$313.95**
Fits '06-'17 Dyna® models with mid controls.

60717-07A Primary Cover. **\$313.95**
Fits '07-'17 Softail® models. Also fits '06-'17 FLD and Dyna models equipped with factory forward controls.

60706-09A Primary Cover. **\$313.95**
Fits '07-'15 Touring and Trike models (except FLHTCUL or FLHTKL).

60715-99B Primary Cover. **\$313.95**
Fits '99-'05 Dyna and '99-'06 Softail models.

17620-99 Rocker Box Cover. **\$107.95**
Fits '99-'17 Dyna, '00-'17 Softail and '99-'16 Touring and Trike models (2 required).

17618-99A Rocker Box Lower Housing. **\$107.95**
Fits '99-'17 Dyna, '00-'17 Softail and '99-'16 Touring and Trike models (2 required).

25364-01B Cam Cover. **\$199.95**
Fits '01-'17 Dyna, Softail and '01-'16 Touring and Trike models (except '01 EFI Touring).

37135-06 Transmission Side Cover. **\$152.95**
Fits '06-'17 Dyna, '07-'17 Softail (except FLSS, FLSTFBS, FXCW, FXCWC, FXSB and FXSE), and '07-'16 Touring and Trike models. Does not fit models equipped with a hydraulic clutch.

37189-99 Transmission Side Cover. **\$143.95**
Fits '99-'05 Dyna, '00-'06 Softail and '99-'06 Touring models.

34521-06B Transmission Top Cover. **\$107.95**
Fits '06-'17 Dyna and '07-'17 Softail, '07-'16 Touring and Trike models.

60713-07 Derby Cover. **\$48.95**
Fits '06-'17 Dyna and '07-'18 Softail (except FLSS), and '07-'15 Touring and Trike models (except FLHTCUL, FLHTKL or '07-'15 Touring or Trike models equipped with Narrow-Profile Outer Primary Cover P/N 25700385 or 25700438).

NOTE: Removing and installing engine covers may require purchase of new gaskets. See dealer for information.

Model Family Fitment:

- V-ROD
- SPORTSTER
- DYNA
- SOFTAIL
- TOURING

Notice: The prices appearing in this catalog are the manufacturer's suggested retail prices. Actual retail prices may vary.

Notice: The prices appearing in this catalog are the manufacturer's suggested retail prices. Actual retail prices may vary.

446 ENGINE TRIM

Engine Covers – Twin Cam

A. TWIN CAM ENGINE COVERS – CHROME

Dress the engine of your Twin Cam-equipped model in chrome. These chrome-plated components are manufactured to Original Equipment specifications for exact fit and finish.

Outer Primary Covers

60764-06A **\$383.95**
Fits '06-'17 Dyna® models with mid controls.

60782-06A **\$383.95**
Fits '06-'17 Dyna models with forward controls and '07-'17 Softail® models.

60553-07A **\$383.95**
Fits '07-'15 Touring and Trike models (except FLHTKL and FLHTCUL).

25700385 Narrow-Profile. **\$383.95**
Fits '07-'16 Touring and Trike models. Installation requires separate purchase of narrow derby cover, derby cover gasket and primary gasket. Chrome is Original Equipment on '15-'16 FLHTCUL and FLHTKL and '16 Touring and Trike models.

60543-99B **\$405.95**
Fits '99-'05 Dyna and '99-'06 Softail models.

60665-99B **\$405.95**
Fits '99-'06 Touring models. Fits '94-'98 Touring models when used with Clutch Cover P/N 60668-99 and Gasket P/N 25416-99C.

Cam Covers

25369-01B **\$191.95**
Fits '01-'17 Dyna, Softail, and '01-'16 Touring and Trike models. (except '01 EFI Touring).

Transmission Side Covers

37116-06 **\$148.95**
Fits '06-'17 Dyna, and '07-'17 Softail (except FLSS, FLSTFBS, FXCW, FXCWC, FXSB and FXSE), and '07-'16 Touring and Trike models. Does not fit models equipped with a hydraulic clutch.

37105-99 **\$252.95**
Fits '99-'05 Dyna, '00-'06 Softail and '99-'06 Touring models.

Rocker and Tappet Covers

Fits '99-'17 Dyna, '00-'17 Softail and '99-'16 Touring and Trike models.

17572-99 Rocker Cover. **\$127.95**

17573-99A Lower Rocker Housing. **\$127.95**

17964-99 Tappet Cover, Front. **\$70.95**

17966-99 Tappet Cover, Rear. **\$70.95**

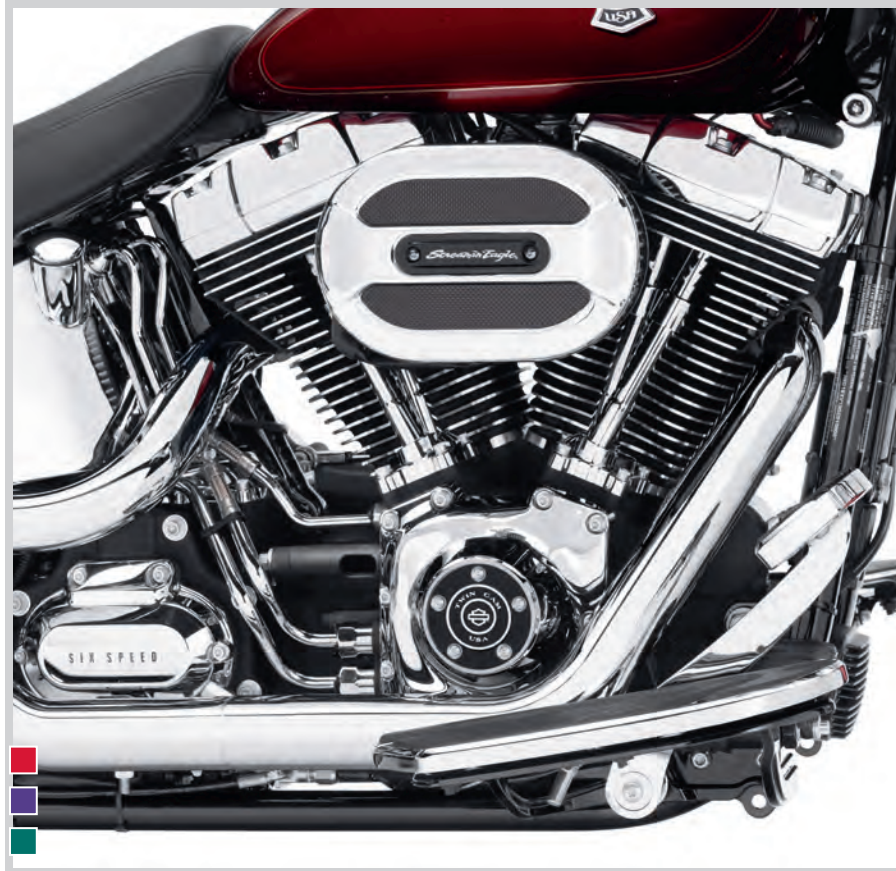

A. TWIN CAM ENGINE COVERS – CHROME



A. TWIN CAM ENGINE COVERS – CHROME



B. INNER PRIMARY COVER TRIM – CHROME (TOURING AND TRIKE SHOWN)



B. INNER PRIMARY COVER TRIM – CHROME



C. CYLINDER BASE COVER – SMOOTH



D. TAPPET BLOCK ACCENT



E. GASKET KIT FOR BLACK INNER PRIMARY



E. GASKET KIT FOR BLACK INNER PRIMARY



E. GASKET KIT FOR BLACK INNER PRIMARY

ENGINE TRIM 447

Engine Covers – Twin Cam

B. INNER PRIMARY COVER TRIM – CHROME

Get the look of a chrome inner primary cover without tearing apart the drive train. Designed to wrap the top surface of the painted inner primary cover, this mirror chrome die-cast shell provides a beefy finished look to the engine cases. Easy to install, the cover is secured with the outer primary hardware, and held in place at four points for quiet operation. Kit includes required mounting hardware. For a complete custom look, consider adding a Chrome Cylinder Base Cover and Classic Chrome Socket Head Screw Covers (sold separately).

60868-10 **\$170.95**
Fits '07-'17 Softail® models (except FLSTSC, FXCW, FXCWC, FXSB, FXSBSE and FXSE). Fits with Original Equipment shift linkage and Polished Shift Linkage P/N 33814-98A.

60885-10 **\$170.95**
Fits '09-'16 Touring and Trike models. Also fits with Chrome Starter Cover P/N 66477-10.

C. CYLINDER BASE COVER – SMOOTH

Add a finished chrome look to the left side of your Twin Cam engine. This easy-to-install kit includes all necessary mounting hardware.

32042-07 **\$74.95**
Fits '07-'17 Softail models (except FLSS and FLSTFBS). Will not fit CVO™ models and models equipped with 110-cubic-inch engines.

32077-07 **\$74.95**
Fits '06-'17 Dyna® (except FXDLS) and '07-'16 Touring and Trike models. Will not fit CVO models and models equipped with 110-cubic-inch engines.

D. TAPPET BLOCK ACCENT

Shaped to fill the gap between the tappet blocks, this unique cover adds a splash of chrome to the profile of your engine. The die-cast cover is polished and chrome-plated to a mirror finish. Easy to install.

61400002 **\$94.95**
Fits '99-'17 Twin Cam-equipped models. Does not fit with Lifter Block Covers P/N 18248-99, 18278-06 and 18262-00 or Billet Lifter Cover P/N 18088-02.

E. GASKET KIT FOR BLACK INNER PRIMARY

It's the details that count. This gasket kit eliminates the silver shadow line you see between the engine and primary. It's the perfect finishing touch any time the primary has been removed for engine service or during the installation of other accessories. Comprehensive kit contains all gaskets and hardware required to reinstall the primary.

25700337 **\$68.95**
Fits '06-'17 Dyna, '07-'17 Softail, and '07-'16 Touring and Trike models.

Also available:
EVOLUTION® 1340 ENGINE COVERS – CHROME

Inspection Covers – with Shifter Hole
60529-90A **\$95.95**
Fits '91-'05 Dyna® models (except FXDWG).

Inspection Covers – without Shifter Hole
60572-86 **\$73.95**
Fits '93-'05 FXDWG and '86-'06 FLST, FXST and FXSTS models.

Model Family Fitment:

- V-ROD
- SPORTSTER
- DYNA
- SOFTAIL
- TOURING

Notice: The prices appearing in this catalog are the manufacturer's suggested retail prices. Actual retail prices may vary.

Notice: The prices appearing in this catalog are the manufacturer's suggested retail prices. Actual retail prices may vary.

448 ENGINE TRIM

Engine Covers – Twin Cam

A. ENGINE/TRANSMISSION INTERFACE COVER

Featuring a ribbed design for sharp surface contrasts, this chrome Engine/Transmission Interface Cover provides a custom option to conceal the space between the cam cover and the transmission. The cover stretches from the gearcase cover to the rear of the transmission, and frames the transmission side cover with a band of chrome for a complete custom look. Kit includes all necessary mounting hardware.

66543-08 **\$107.95**
Fits '07-'17 Softail® models (except FLSS, FLSTFBS, FLSTNSE, FLSTSC, FXCW, FXCWC, FXSB, FXSBSE and FXSE). Does not fit models equipped with hydraulic clutch.



A. ENGINE/TRANSMISSION INTERFACE COVER



B. STARTER COVER – CHROME

With the under-chassis exhaust crossover on the late model Touring bikes, the painted starter motor is now easily seen from both sides of the bike. This brilliantly chrome-plated cover conceals the starter motor and starter solenoid for a clean, custom look. Easy to install, this kit includes all required mounting hardware.

66477-10 **\$74.95**
Fits '09-'16 Touring and Trike models (except CVO™ and models with High Output Starter P/N 31621-06A or 31619-06A).



B. STARTER COVER – CHROME



C. HARLEY-DAVIDSON® GENUINE HIGH PERFORMANCE 1.4KW STARTER

This starter offers both great styling and increased performance, providing 15% greater torque than the stock replacement starter. Engineered and tested by Harley-Davidson from the ground up, this starter offers unparalleled reliability and durability. No special battery or battery cable requirements.

Fits '06-'17 Dyna® (except ABS equipped models) and '07-'17 Softail and '07-'16 Touring and Trike models.

31619-06A Black Finish. **\$457.95**
31621-06A Chrome Finish. **\$598.95**

Fits '99-'00 FXR, '94-'05 Dyna and '94-'06 Softail and Touring models.

31335-03A Black Finish. **\$457.95**
31559-99A Chrome Finish. **\$598.95**



C. HARLEY-DAVIDSON GENUINE HIGH PERFORMANCE 1.4KW STARTER – CHROME

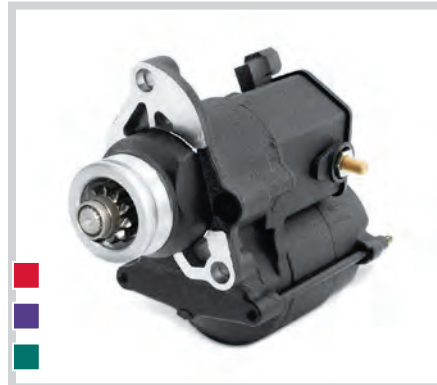

C. HARLEY-DAVIDSON GENUINE HIGH PERFORMANCE 1.4KW STARTER – BLACK

D. STARTER SOLENOID COVER KIT – CHROME

Add chrome to an often overlooked area with this cover, featuring the same high-quality, bright finish used on most of our accessories.

31783-00 **\$33.95**
Fits '94-later models (except '02-'17 VRSC™, '15-later XG, '18-later Softail and '17-later Touring and Trike models).



D. STARTER SOLENOID COVER KIT – CHROME



E. BILLET FRONT ENGINE MOUNT BRACKET



F. FRONT ENGINE MOUNT COMPONENTS – BLACK



G. PUSHROD COVER KIT – GLOSS BLACK



H. PUSHROD TUBE COLLARS – GLOSS BLACK



I. TAPPET COVERS – BLACK



J. STARTER MOTOR END COVER – GLOSS BLACK (SHOWN WITH SPEED CHECK TRANSMISSION DIPSTICK)

ENGINE TRIM 449

Engine Covers – Twin Cam

E. FRONT ENGINE MOUNT COMPONENTS – CHROME

A must-have for any chrome connoisseur, this chrome-plated Front Engine Mount Bracket will set your custom apart from the rest. The chrome bracket is machined from premium 6061-T6 aluminum, and is a direct bolt-on replacement for the Original Equipment bracket. Can be used with the stock stabilizer link, or dressed up with the optional chrome Front Engine Mount Stabilizer Link P/N 16213-10. Kit includes chrome mounting hardware.

16205-10 Front Engine Mount Bracket. **\$139.95**
Fits '08-'16 Touring models.

Add a custom style to the front end with this brilliant chrome-plated Engine Mount Stabilizer Link. This custom heim joint assembly complements the chrome Billet Front Engine Mount Bracket P/N 16205-10. Kit includes chrome mounting hardware.

16213-10 Front Tie Link. **\$59.95**
Fits '09-later Touring and Trike models.

F. FRONT ENGINE MOUNT COMPONENTS – BLACK

Perfect for installation on a blacked-out engine, these black engine mount components replace the factory silver-finished parts and blend these functional items into the background. Manufactured from Original Equipment components for perfect fit and proven reliability.

16400056 Front Engine Mount Bracket. **\$48.95**
Fits '08-'16 Touring models.

16400055 Front Tie Link. **\$43.95**
Fits '09-later Touring models.

G. PUSHROD COVER KIT – GLOSS BLACK

Complete the Dark Custom look. These covers replace existing chrome covers to give your bike a blacked-out appearance down to the smallest detail. Pushrod covers are finished in gloss black and the kit includes the four bottom cover tubes and the four upper clips. Installation retains the Original Equipment chrome short center tube to create a high-contrast accent. Cover Kit can be installed on engines already equipped with Adjustable Pushrods or can be installed by removing rocker box covers, rocker arms and non-adjustable pushrods. Consult your dealer or service manual for installation.

17900033 Covers Only. **\$76.95**
Fits '99-'17 Twin Cam-equipped models. Requires prior installation of Adjustable Pushrods or removal of rocker box covers, rocker arms and fixed-length pushrods.

H. PUSHROD TUBE COLLARS – GLOSS BLACK

Manufactured from Original Equipment components for perfect fit and function, these Pushrod Collars complete your Twin Cam engine's conversion to the total blacked-out look. Covers replace the chrome-finished factory covers, and fit with stock or Screamin' Eagle® Quick-Install Pushrods.

17900076 **\$38.95**
Fits '84-'00 Evolution® 1340 and '99-'17 Twin Cam-equipped models. Installation requires use of Adjustable Pushrods or removal of rocker box covers, rocker arms and fixed-length pushrods.

I. TAPPET COVERS – BLACK

Complete your Twin Cam engine's conversion to a total blacked-out look. These textured black tappet blocks replace the stock bright-finished components for a sinister appearance, and are manufactured from Original Equipment components for perfect fit and function.

25700653 **\$152.95**
Fits '99-'17 Twin Cam-equipped models. Sold in pairs.

J. STARTER MOTOR END COVER – GLOSS BLACK

It's the details that make the complete custom bike. This gloss black round starter end cover replaces the factory-installed chrome cover and is the ideal finishing touch for converting your powertrain to an elegant tuxedo black look. Manufactured from Original Equipment components to ensure a perfect fit, this cover is coated with temperature-resistant finish to ensure a long-lasting finish.

31400092 **\$28.95**
Fits '08-'16 Touring and Trike models.

Model Family Fitment:

- V-ROD
- SPORTSTER
- DYNA
- SOFTAIL
- TOURING

Notice: The prices appearing in this catalog are the manufacturer's suggested retail prices. Actual retail prices may vary.

Notice: The prices appearing in this catalog are the manufacturer's suggested retail prices. Actual retail prices may vary.

450 ENGINE TRIM

Sportster® Engine & Transmission Trim

A. RAIL COLLECTION ENGINE COVERS

Tough broad-shouldered attitude with an edge – that’s what you get when you finish your ride with the Rail Collection. We start with factory engineered components to ensure perfect fit and function. Then we apply a rich durable gloss black finish to draw attention to the heart of the bike, and then add machined longitudinal strakes to provide visual length to the powertrain. The resulting look is masculine and aggressive – and it mixes well with either café or urban assault styles. Start with a couple of components, or go all the way.

1. Primary Cover

25700532 **\$284.95**
Fits '06-'22 XL models. Includes gloss black Chain Inspection Cover.

2. Transmission Sprocket Cover

34800032 **\$199.95**
Fits '04-'22 XL models. Does not fit models equipped with Rear Set Foot Controls P/N 50700040.

NOTE: Removing and installing engine covers may require purchase of new gaskets. See dealer for information.

Shown with:

SCREAMIN' EAGLE® PERFORMANCE AIR CLEANER KIT – RAIL COLLECTION

The look is bold and the performance exhilarating. This race-inspired air cleaner is engineered to flow through the perimeter and the face of the air filter, providing high volumes of unrestricted airflow to the engine. The open-design face plate features a rich black finish with machined longitudinal strakes to expose the glowing aluminum below. Kit includes air cleaner trim, one-piece cast back plate, high-flow washable air filter element, rain sock and all required hardware. 50-State U.S. EPA compliant.

29400232A

\$347.95

Fits '07-'22 XL models with Original Equipment throttle body. All models require ECM calibration for proper installation. '17-later models require recalibration with Screamin' Eagle® Pro Street Tuner (sold separately). Pending approval for use in California on '21 models. Refer to H-D.com/shop for status.



A. RAIL COLLECTION ENGINE COVERS

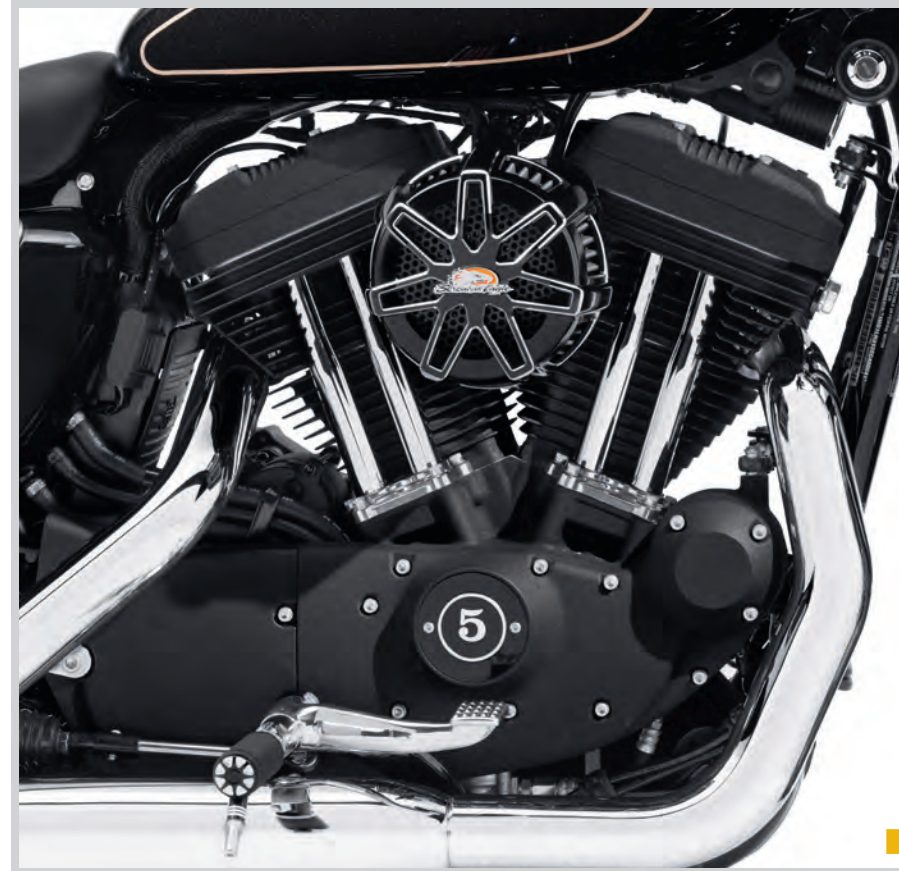

B. WRINKLE BLACK ENGINE COVERS

ENGINE TRIM 451

Sportster® Engine & Transmission Trim

B. WRINKLE BLACK ENGINE COVERS

These black powder-coated engine covers are the perfect start in converting your powertrain to a striking wrinkle black look. Manufactured from Original Equipment components, these covers are masked and painted on the factory production paint line to ensure a matching wrinkle black or texture black finish and a perfect fit. Complete the blacked-out look with matching primary covers, rocker housings, rocker covers, cam covers and transmission covers (sold separately).

1. Gearcase Cover

25486-05 Fits '04-'22 XL models. **\$404.95**

2. Transmission Sprocket Cover

34943-05 Fits '04-'22 XL models. **\$87.95**

3. Rocker Box Lower Housing (each)

17645-07A Fits '07-'22 XL models. **\$110.95**

4. Rocker Box Cover (each)

17655-05 Fits '04-'22 XL models. **\$82.95**

5. Primary Cover

25307-06 Fits '06-'22 XL models. **\$295.95**

6. Primary Chain Inspection Cover

34794-05A Fits '04-'22 XL models. **\$23.95**

7. Derby Cover

34790-05 Fits '04-'22 XL models. **\$43.95**

NOTE: Removing and installing engine covers may require purchase of new gaskets. See dealer for information.

Shown with:

SCREAMIN' EAGLE® EXTREME BILLET AIR CLEANER KIT – CHISEL

The bold styling of this intake system looks just as impressive as the long patch of burnout rubber you just laid down. The forged billet aluminum cover tops off a cast back plate with integral breather for a smooth transition to the throttle body. The race-inspired air cleaner is engineered to flow high volumes of air and the washable pleated element provides the ideal combination of efficiency and engine protection. Available in your choice of style and finish, this easy-to-install kit includes all mounting hardware and rain sock. 50-State U.S. EPA compliant.

29400127

Cut Back Gloss Black. **\$399.95**
Fits '07-'22 XL models with Original Equipment throttle body. All EFI models require ECM calibration for proper installation. '17-later models require recalibration with Screamin' Eagle® Pro Street Tuner (sold separately). Labor cost not included. See Dealer for details.



A. RAIL COLLECTION ENGINE COVERS



B. WRINKLE BLACK ENGINE COVERS



GO LIGHT These Screamin' Eagle products are 50-state street compliant for sale and use on all vehicles, including those that are pollution-controlled. Complies with the requirements of 40 CFR Part 86, subparts E and F. Street legal and/or street compliant statements refer to product meeting 50-state emissions and noise standards in the United States.

Notice: The prices appearing in this catalog are the manufacturer's suggested retail prices. Actual retail prices may vary.



GO LIGHT These Screamin' Eagle products are 50-state street compliant for sale and use on all vehicles, including those that are pollution-controlled. Complies with the requirements of 40 CFR Part 86, subparts E and F. Street legal and/or street compliant statements refer to product meeting 50-state emissions and noise standards in the United States.

Model Family Fitment:

- V-ROD
- SPORTSTER
- DYNA
- SOFTAIL
- TOURING

Notice: The prices appearing in this catalog are the manufacturer's suggested retail prices. Actual retail prices may vary.

452 ENGINE TRIM

Sportster® Engine & Transmission Trim

A. CHROME ENGINE COVERS

Dress the engine of your Sportster® model in chrome. These polished and chrome-plated components are manufactured to Original Equipment specifications for exact fit and finish.

1. Primary Cover		
25460-06	Fits '06-'22 XL models.	\$383.95
25460-04	Fits '04-'05 XL models.	\$383.95
2. Gearcase Cover		
25213-04	Fits '04-'22 XL models.	\$481.95
3. Transmission Sprocket Cover		
34932-04	Fits '04-'22 XL models.	\$142.95
4. Rocker Box Lower Housing (each)		
17537-07A	Fits '07-'22 XL models.	\$127.95
17537-96C	Fits '86-'06 XL models.	\$127.95
5. Rocker Box Cover (each)		
17551-04	Fits '04-'22 XL models.	\$107.95
6. Primary Chain Inspection Cover		
34761-04A	Fits '04-'22 XL models.	\$28.95
7. Derby Cover		
34760-04	Fits '04-'22 XL models.	\$74.95

Also available:

CHROME ENGINE KIT – SPORTSTER®

Upgrade your motor with brilliant chrome components. Kit includes chrome gear cover, transmission sprocket cover, primary chain inspection cover, derby cover, inner and outer rocker covers and all gaskets.

16295-07A	\$1,048.95
Fits '07-'22 XL models. Stock on '07-'22 XL1200C, XL1200L, XL1200T, XL1200V and XL 50th Anniversary models.	

Shown with:

SMOOTH AIR CLEANER COVER

Wrap your Screamin' Eagle® round air cleaner element in style. The mirror chrome low-profile Air Cleaner Cover shields the element and opens breathing space between the backing plate and the cover. Cut-away bottom design exposes the air cleaner element to maximize the airflow. Easy to install, the one-piece cover is the ideal complement to the Chrome Air Cleaner Back Plate P/N 29510-05.

29153-07	\$54.95
Fits '07-'22 XL models equipped with Screamin' Eagle Round High-Flow Air Cleaner Kits and '99-'17 Twin Cam models equipped with Screamin' Eagle Round High-Flow Air Cleaner Kits.	



A. CHROME ENGINE COVERS



A. CHROME ENGINE COVERS

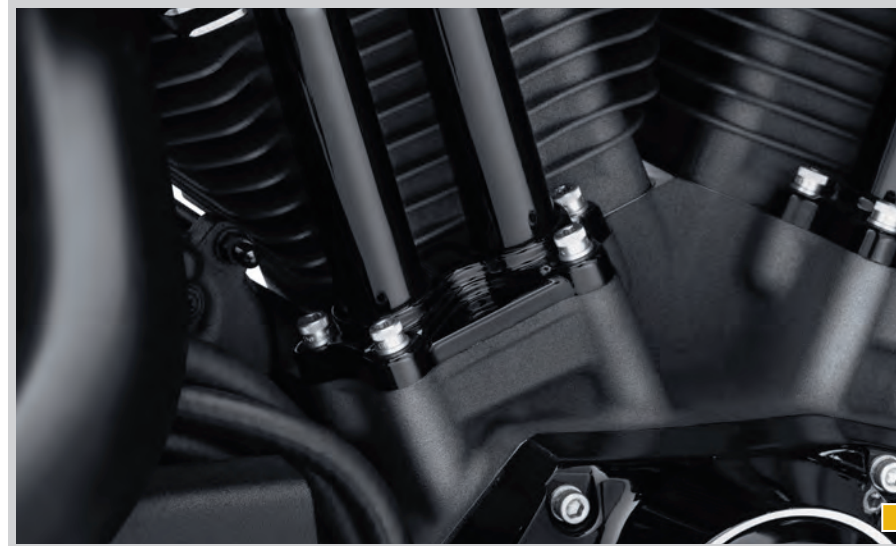

B. PUSHROD COVER KIT – GLOSS BLACK



C. TAPPET COVERS – GLOSS BLACK



D. FRONT ENGINE MOUNT STABILIZER LINK

ENGINE TRIM 453

Sportster® Engine Trim

B. PUSHROD COVER KIT – GLOSS BLACK

These Pushrod Covers add to your bike's blacked-out look and are coated with durable, heat-resistant gloss black paint. The kit includes four bottom cover tubes and four upper clips. Pushrod Covers are a great add-on when upgrading the top end of your engine with Screamin' Eagle® performance cylinder heads.

17900083	\$66.95
Fits '04-'22 XL and XR models. Includes 4 Pushrod covers. Requires removal of cylinder heads for installation.	

C. TAPPET COVERS – GLOSS BLACK

Complete your Sportster® engine's conversion to a total blacked-out look. These Tappet Covers replace the bright-finished stock covers and are manufactured from Original Equipment components with heat-resistant gloss black paint for perfect fit and function.

17900084	\$87.95
Fits '04-'22 XL and XR models. Includes 2 covers and 2 gaskets. Requires removal of cylinder heads for installation.	

D. FRONT ENGINE MOUNT STABILIZER LINK

Add a custom style to the front end with this brilliant chrome-plated Engine Mount Stabilizer Link. This custom heim joint assembly is designed to link the engine to the engine mount bracket and can be used to replace the Original Equipment upper or lower front tie link. For a complete transformation, install two Stabilizer Links and the complementing chrome Billet Front Engine Mount Bracket P/N 16400022. Kit includes one stabilizer link and chrome mounting hardware.

16400020	\$54.95
Fits '04-'22 XL and '08-'13 XR models.	

Model Family Fitment:

■ V-ROD	■ SPORTSTER	■ DYNA
■ SOFTAIL	■ TOURING	

Notice: The prices appearing in this catalog are the manufacturer's suggested retail prices. Actual retail prices may vary.

Notice: The prices appearing in this catalog are the manufacturer's suggested retail prices. Actual retail prices may vary.

454 ENGINE TRIM

Air Cleaner Covers

A. 120TH ANNIVERSARY AIR CLEANER TRIM – STANDARD

Celebrate 120 years of Harley-Davidson pride and craftsmanship. This easy-to-install accessory trim is also standard equipment on the limited-edition Harley-Davidson® 120th Anniversary models. Handsome red fade finish with subtle gold and black accents.

61301326 **\$49.95**

Fits '17-later Touring and Trike models with Original Equipment wedge shaped air cleaner cover. Does not fit CVO™ models.



A. 120TH ANNIVERSARY AIR CLEANER TRIM – STANDARD

B. 120TH ANNIVERSARY AIR CLEANER TRIM – VENTILATOR

Celebrate 120 years of Harley-Davidson pride and craftsmanship. This easy-to-install accessory trim is also standard equipment on the limited-edition Harley-Davidson® 120th Anniversary models. Handsome red fade finish with subtle gold and black accents.

61301327 **\$49.95**

Fits '18-later Softail® and '17-later Touring and Trike models equipped with Ventilator Air Cleaner P/N 29400298 or 29400299. Also fits '18-later Softail® models with 114CI engines and '17-later CVO™ touring models with Original Equipment Ventilator Air Cleaner with separate purchase of Air Filter P/N 29400293.



B. 120TH ANNIVERSARY AIR CLEANER TRIM – VENTILATOR

C. AIR CLEANER TRIM – BRUSHED ALUMINUM

Show off your Milwaukee-Eight® engine's displacement with pride. Available for 107- and 114-cubic-inch engines, this brushed aluminum and black trim is the perfect complement to chrome or black engine finishes. This easy-to-install self-adhesive formed aluminum trim fits perfectly into the recessed face of the Softail models Original Equipment perimeter bolt air cleaner cover.

61300788 107 Logo. **\$48.95**
Fits '18-later FLFB, FL5B, FXBB, FXBR and FXFB models with Original Equipment perimeter bolt air cleaner cover.



C. AIR CLEANER TRIM – BRUSHED ALUMINUM

D. AIR CLEANER COVER – GLOSS BLACK

Complete the blacked-out look. Original Equipment on the FLSS model, this Gloss Black Air Cleaner Cover adds a sinister touch without changing the signature profile of your late model Twin Cam motor.

61300536 **\$76.95**

Fits '16-'17 Softail (except FLSTFBS) and '14-'16 Touring and Trike models (except CVO™) with Original Equipment Air Cleaner or models equipped with Screamin' Eagle Round High-Flow Air Cleaner P/N 29400233 or 29400234.



D. AIR CLEANER COVER – GLOSS BLACK

E. SCREAMIN' EAGLE® VENTILATOR ELITE AIR CLEANER COVER

Add a luxurious finishing touch to your Ventilator Air Cleaner. Designed as a direct replacement for the Screamin' Eagle® and CVO™ Ventilator Air Cleaners, this easy-to-install cover features a sleek center bar design surrounded with carbon fiber inserts. Kit includes low-profile cover, diamond-cut Screamin' Eagle medallion and chrome mounting hardware.

Fits '10-'17 Dyna®, '09-'16 Softail®, '09-'16 Touring and Trike models equipped with Ventilator Air Cleaner Kits. Also fits Dyna HO103 and CVO™ models with Original Equipment Ventilator Air Cleaner.

61300516 Chrome. **\$121.95**

61300517 Gloss Black. **\$121.95**



E. SCREAMIN' EAGLE VENTILATOR ELITE AIR CLEANER COVER – CHROME



E. SCREAMIN' EAGLE VENTILATOR ELITE AIR CLEANER COVER – GLOSS BLACK



F. MILWAUKEE-EIGHT ENGINE AIR CLEANER COVER – GLOSS BLACK



G. NOSTALGIC BAR & SHIELD LOGO AIR CLEANER COVER – ROUND



H. SMOOTH AIR CLEANER COVER



I. BOBBER-STYLE ROUND AIR CLEANER COVER – CHROME



I. BOBBER-STYLE ROUND AIR CLEANER COVER – GLOSS BLACK

ENGINE TRIM 455

Air Cleaner Covers

F. MILWAUKEE-EIGHT® ENGINE AIR CLEANER COVER – GLOSS BLACK

Complete the blacked-out look. This Gloss Black Air Cleaner Cover adds a sinister touch without changing the signature profile of your Milwaukee-Eight® engine.

61300828 **\$74.95**

Fits '17-later Touring (except CVO™) and Trike models with Original Equipment air cleaner or Screamin' Eagle® Wedge High-Flow Air Cleaner.

G. NOSTALGIC BAR & SHIELD LOGO AIR CLEANER COVER

Get a polished look with an extra dose of heritage with the Nostalgic Collection – chrome-plated air cleaner covers featuring an original-style Bar & Shield logo and a stamped "Made in U.S.A." An easy-to-install trip down memory lane, each cover is hand-polished and chrome-plated to a brilliant finish. Available in oval and round configurations, the air cleaner kit includes polished stainless steel mounting hardware.

29138-91A Round. **\$94.95**

Fits '90-'99 carbureted (CV) Evolution® 1340-equipped models. Also fits '07-'22 XL and '99-'17 Twin Cam models equipped with Screamin' Eagle High-Flow Air Cleaners (round filter) when installed with Gasket Kit P/N 29591-99 (sold separately).

H. SMOOTH AIR CLEANER COVER

Wrap your Screamin' Eagle round air cleaner element in style. The mirror chrome low-profile Air Cleaner Cover shields the element and opens breathing space between the backing plate and the cover. Cut-away bottom design exposes the air cleaner element to maximize the airflow. Easy to install, the one-piece cover is the ideal complement to the Chrome Air Cleaner Back Plate P/N 29510-05.

29153-07 **\$54.95**

Fits '07-'22 XL models equipped with Screamin' Eagle Round Filter Air Cleaner Kits and '99-'17 Twin Cam models equipped with Screamin' Eagle Round High-Flow Air Cleaner Kits.

I. BOBBER-STYLE ROUND AIR CLEANER COVER

Low-profile round air cleaner cover adds an attractive nostalgic look to any bike's profile. The cover features a cut-away bottom design that exposes the filter element to maximize the airflow when installed with a Screamin' Eagle High-Flow Air Cleaner Kit.

Fits '12-'16 XL1200V and '11-'15 FLS and FXS models with Original Equipment round air cleaner. Also fits models equipped with Screamin' Eagle Round High-Flow Air Cleaner Kits.

61300120 Chrome. **\$59.95**

61300128 Gloss Black. **\$59.95**

Model Family Fitment:

V-ROD
 SPORTSTER
 DYNA
 SOFTAIL
 TOURING

Notice: The prices appearing in this catalog are the manufacturer's suggested retail prices. Actual retail prices may vary.

Notice: The prices appearing in this catalog are the manufacturer's suggested retail prices. Actual retail prices may vary.

456 ENGINE TRIM

Oil Temp & Level

A. OIL LEVEL AND TEMPERATURE DIPSTICK WITH LIGHTED LCD READOUT

New and improved capacitive level sensing technology provides the highest degree of accuracy and durability. Now available in chrome and black, these dipsticks allow you to check your oil level and oil temperature with the push of a button. Add function and style by replacing your stock dipstick with this hard-working version. No more grabbing a rag to pull your hot dipstick. No more oil drips on your pipes and on the garage floor. Simply push the button and this dipstick lights up with a brilliant backlight. Oil level is indicated by a four-segment readout—it even reminds you to check your oil when it is hot. Designed to be waterproof, the LCD (liquid crystal display) readout operates on a long-lasting, replaceable lithium coin-type battery (CR2032 3V, P/N 91800066). Display features a low battery indicator and press-and-hold feature to toggle between Fahrenheit and Celsius.

Fits '04-'22 XL and XR models.

62700009 Chrome. **\$164.95**

62700011 Gloss Black. **\$164.95**

Fits '06-'17 Dyna® models (except FLD).

63065-09A Gloss Black. **\$164.95**

Fits '00-'17 Softail® models (except FXCW, FXCWC, FXSB, FXSBSE, FXSE and '09 FXSTSSE).

62955-09A Chrome. **\$164.95**

63055-09A Gloss Black. **\$164.95**

Fits '08-'17 FXCW, FXCWC, FXSB, FXSBSE, FXSE and '09 FXSTSSE models.

63002-09A Chrome. **\$164.95**

Fits '17-later Touring models.

62700180 Chrome. **\$164.95**

62700194 Gloss Black. **\$164.95**

Fits '07-'16 Touring models (except models equipped with a Sidecar). Will not fit Touring models equipped with Engine/Transmission Interface Cover P/N 66532-07.

63004-09A Chrome. **\$164.95**

63030-09A Gloss Black. **\$164.95**

Fits '02-'06 Touring models (except models equipped with a Sidecar). Also fits '99-'01 Touring models equipped with Chrome Oil Filler Spout P/N 62470-02, 62453-02 or 62454-02A.

62946-09A Chrome. **\$164.95**

63131-09A Gloss Black. **\$164.95**

Fits '09-'16 Trike models. Also fits '09-'16 Touring models equipped with a sidecar.

62700005A Chrome. **\$164.95**

Also available:

LCD DIPSTICK BATTERY AND SEAL KIT

Kit includes CR2032 3V Lithium Replacement Battery and waterproof seal kit.

91800066 **\$10.95**



A. OIL LEVEL AND TEMPERATURE DIPSTICK – CHROME (DYNA SHOWN)



A. OIL LEVEL AND TEMPERATURE DIPSTICK – BLACK (DYNA SHOWN)



A. OIL LEVEL AND TEMPERATURE DIPSTICK – CHROME (SPORTSTER SHOWN)



A. OIL LEVEL AND TEMPERATURE DIPSTICK – BLACK (SOFTAIL SHOWN)



B. OIL DIPSTICK WITH TEMPERATURE GAUGE (SOFTAIL SHOWN)



B. OIL DIPSTICK WITH TEMPERATURE GAUGE ('04-LATER SPORTSTER SHOWN)

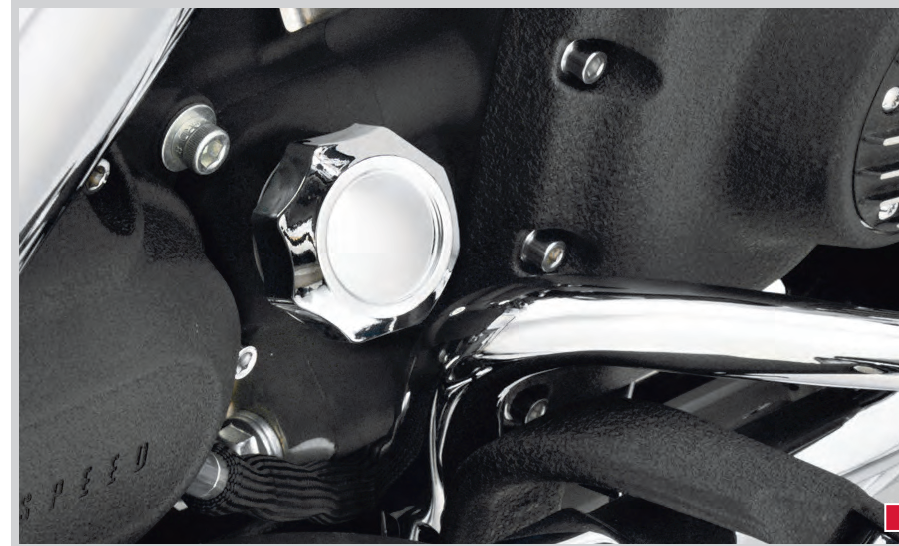

C. CHROME OIL DIPSTICK – '06-LATER DYNA



D. FUEL TANK FITTING COVER



E. BRAIDED STAINLESS STEEL EFI FUEL LINE



F. BRAIDED STAINLESS STEEL FUEL CROSSOVER LINE

ENGINE TRIM 457

Oil Level Dipsticks & Fuel Lines

C. CHROME OIL DIPSTICK

Easy-to-install chrome-plated oil dipstick adds a finishing touch and shows your attention to detail.

62858-99 Fits '99-'06 Touring models. **\$54.95**

D. FUEL TANK FITTING COVER

This classic chrome styled two-piece die-cast cover conceals the EFI fuel line fitting below the tank. Easy to install, the kit includes chrome-plated hardware and hex key wrench.

62809-06 **\$35.95**

Fits '04-'07 fuel injected Dyna®, '02-'17 fuel injected Softail® and '03-'16 fuel injected Touring and Trike models.

E. BRAIDED STAINLESS STEEL EFI FUEL LINE

Add a finishing touch to the fuel-injected Dyna with this Braided Stainless Steel Fuel Line. Complete replacement line includes pre-installed fuel tank and EFI module connectors.

63020-04 **\$43.95**

Fits '04-'05 EFI Dyna models.

F. BRAIDED STAINLESS STEEL FUEL CROSSOVER LINE

A beautifully Braided Stainless Steel Fuel Line accented with highly polished chrome fittings for your front fuel tank crossover. Innovative fittings are designed to eliminate unsightly hose clamps.

63698-02 Fits '97-'07 Touring models. **\$41.95**

63692-00A **\$41.95**

Fits '00-'17 Softail models (except FXCW, FXCWC and FXSTD).

Model Family Fitment:

- V-ROD
- SPORTSTER
- DYNA
- SOFTAIL
- TOURING

Notice: The prices appearing in this catalog are the manufacturer's suggested retail prices. Actual retail prices may vary.

Notice: The prices appearing in this catalog are the manufacturer's suggested retail prices. Actual retail prices may vary.

458 ENGINE TRIM

Cylinder Head Covers

A. FINNED HEADBOLT BRIDGE

This exclusive aluminum Finned Headbolt Bridge covers both headbolts and the spark plug, filling out your cylinder fins all the way to the rocker box. Featuring an engraved Bar & Shield emblem, the bridge is easy to install with unique headbolt mounts. All necessary mounting hardware included. Sold in pairs.

43859-00	Black Highlighted.	\$69.95
Fits '99-'17 Twin Cam-equipped models with electronic fuel injection and '00-later FXSTD models.		
61400148	CVO™ Granite Highlighted.	\$69.95
Fits '99-'17 Twin Cam-equipped models with electronic fuel injection and '00-later FXSTD models.		
61400176	Solid Black.	\$59.95
Fits '04-'22 XL models.		



A. FINNED HEADBOLT BRIDGE – BLACK HIGHLIGHTED



A. FINNED HEADBOLT BRIDGE – CVO GRANITE HIGHLIGHTED

B. HEADBOLT BRIDGE – CHROME

This exclusive Headbolt Bridge covers both the headbolts and spark plug with a splash of chrome and an engraved Bar & Shield emblem. Easy to install with unique headbolt mounts. Kit includes all necessary mounting hardware. Sold in pairs.

43858-00	Chrome.	\$69.95
Fits '99-'17 Twin Cam-equipped models. (Will not fit with Screamin' Eagle® heads or 110Cl or 117Cl engines.)		
44432-04	Chrome.	\$69.95
Fits '04-'22 XL and XR models.		



A. FINNED HEADBOLT BRIDGE – SOLID BLACK



B. HEADBOLT BRIDGE – CHROME

C. SPARK PLUG COVER KITS

Quickly slips over spark plug for a secure fit.

32747-99	Classic Chrome.	\$28.95
Fits '99-'17 Twin Cam-equipped models.		
32745-99	H-D Motor Co. Logo.	\$28.95
Fits '99-'17 Twin Cam-equipped models.		

D. HEADBOLT COVERS

Precision-machined of high-quality aluminum and manufactured in the U.S.A. Hand-polished and chrome-plated. Available in a variety of styles to match your customizing direction, these kits include 4 easy-to-install headbolt covers, set screws and an Allen® wrench for easy installation.

Fits '86-'22 XL, '08-'13 XR, '85-'99 Evolution® 1340 and '99-'17 Twin Cam models.

1. 43822-01	Chrome.	\$47.95
2. 43896-99	Gloss Black.	\$47.95
3. 43911-95	Chrome Bar & Shield Logo.	\$43.95
4. 43884-96	Chrome H-D Motor Co. Logo.	\$43.95



C. SPARK PLUG COVERS (32745-99 SHOWN)



C. SPARK PLUG COVERS (32745-99 SHOWN)

E. CLASSIC CHROME ROCKER BOX BOLT COVERS

Matching the styling of our classic chrome headbolt covers, these chrome-plated Rocker Box Bolt Covers add chrome to your engine. Easy to install, the covers are held in place by a spring steel clip. Sold in packages of four.

43868-99	Chrome.	\$30.95
Fits '99-'17 Twin Cam-equipped models.		



D. HEADBOLT COVERS



E. CLASSIC CHROME ROCKER BOX BOLT COVERS

Model Family Fitment:

■ V-ROD	■ SPORTSTER	■ DYNA
■ SOFTAIL	■ TOURING	

Notice: The prices appearing in this catalog are the manufacturer's suggested retail prices. Actual retail prices may vary.

ENGINE TRIM 459

Docking Hardware Covers

F. REAR DOCKING HARDWARE COVER KIT

Disguise the rear docking hardware with these easy-to-install covers. The caps slide over the exposed docking points, and are held in place by a strong magnetic pull. The caps are easy to remove when you wish to reinstall detachable accessories. Covers are available with brilliant chrome or durable gloss black finish to match your bike's attitude. Sold in pairs.

Fits many accessory docking hardware kits. Refer to the fitment matrix below or the Parts & Accessories section of www.harley-davidson.com for details.

48218-10	Short Chrome (pair).	\$38.95
48220-10	Large Chrome (pair).	\$38.95
48035-09	Small Chrome (pair).	\$38.95
48221-10	Short Black (pair).	\$38.95
48223-10	Large Black (pair).	\$38.95
48225-10	Small Black (pair).	\$38.95



F. REAR DOCKING HARDWARE COVER KIT – CHROME



F. REAR DOCKING HARDWARE COVER KIT – BLACK



Docking Kit Part Number	Fitment	Large Chrome: 48220-10 Black: 48223-10	Small Chrome: 48035-09 Black: 48225-10	Short Chrome: 48218-10 Black: 48221-10
XL Models				
53529-04	Fits '04-'22 XL (some black) models.	—	1	1
53532-02	Fits '02-'03 XL (with bags) models.	1	—	—
90465-98A	Fits '94-'01 XL (with bags) models.	1	—	—
Dyna® Models				
53961-06	Fits '06-'17 Dyna® (FXD/L) models.	—	1	1
53964-06B	Fits '08-'17 FXDF, '09-'10 FXDFSE and '06-'08 FXDWG models.	—	1	1
54097-10	Fits '10-'17 FXDWG (black) models.	—	1	1
53797-09	Fits '09-'17 FXDB (black) models.	—	1	1
53858-01	Fits '96-'01 FXDWG (except FXDWG2) models.	1	—	—
Softail® Models				
53932-03A	Fits '03-'17 Softail® (without bags) models.	1	1	—
Touring Models				
52300131	Fits '14-later Touring (4pt) chrome models.	—	2	—
52300353	Fits '14-later Touring (4pt) chrome models.	—	2	—
52300354	Fits '14-later Touring (4pt) black models.	—	2	—
54205-09	Fits '09-'13 Touring (4pt) chrome models.	—	2	—
54246-09	Fits '09-'13 Touring (4pt) black models.	—	2	—
54030-09	Fits '09-'13 Touring (2pt) chrome models.	—	1	—
54249-09	Fits '09-'13 Touring (2pt) black models.	—	1	—
53803-06	Fits '97-'08 Touring (front) models.	—	1	—
53804-06	Fits '94-'08 Touring (rear) models.	1	1	—
53988-07	Fits '07-'08 FLHRSE3/4 models.	—	1	1

Notice: The prices appearing in this catalog are the manufacturer's suggested retail prices. Actual retail prices may vary.

460 ENGINE TRIM

Hardware Covers

A. CLASSIC COVERS KIT

Customize your bike down to the last detail. These hardware Cover Kits include the chrome-plated ABS caps and plugs in the sizes and styles required to dress the viewable hardware on the motorcycle. Classic Covers are available as complete Bike Kits with the covers for both engine and chassis hardware, or as engine-only kits to dress the Twin Cam or XL engine. The kits are easy to install, with no tools required.

94923-09	Bike Kit.	\$297.95
Fits '09-'17 Softail® models (except FLS, FLSS, FLSTSB, FXCW, FXCWC and FXSE).		
94924-09	Bike Kit.	\$286.95
Fits '09-'13 Touring and Trike models.		
94943-07	Engine Kit.	\$170.95
Fits Twin Cam-equipped models.		



A. CLASSIC COVERS KIT

Typical Classic Covers Kit Contents

Intended Fastener	Part Number	Bike Kit	Bike Kit	Engine Kit
		'09-'17 Softail	'09-'16 Touring	Twin Cam models
		94923-09	94924-09	94943-07
1/4" socket head cap screw	94903-07	50	55	50
5/16" socket head cap screw	94904-07	11	8	7
5/16" socket head cap screw (plug)	94905-07	4	—	—
3/8" socket head cap screw	94906-07	6	3	3
5/16" special hex screw (angled cap)	94907-07	8	8	8
5/16" T40 Torx® button head screw	94908-07	5	10	—
3/8" T45 Torx button head screw	94909-07	5	—	—
1/4" 12-point screw	94910-07	—	—	—
10mm 12-point screw	94911-07	5	4	—
1/2" flanged hex bolt	94912-07	1	2	—
3/8" T45 Torx button head screw	94913-07	10	2	—
7/16" hex bolt	94914-07	5	—	—
3/8" hex bolt (9/16" hex)	94915-07	1	—	3
3/8" deep hex bolt (9/16" hex)	94916-07	—	—	—
1/4" hex bolt (7/16" hex)	94917-07	—	14	—
5/16" hex bolt (1/2" hex)	94918-07	4	10	8
1/2" hex bolt	94919-07	4	—	—
1/2" deep hex bolt	94920-07	1	—	—
7/16" hex bolt	94941-07	—	—	—
5/16" T40 Torx button head screw	94942-07	4	—	—

Notice: The prices appearing in this catalog are the manufacturer's suggested retail prices. Actual retail prices may vary.

ENGINE TRIM 461

Hardware Covers

B. CHROME SOCKET HEAD SCREW COVER KIT

Finish the show-winning look with these easy-to-install hardware covers. These machined brass and chrome-plated covers are corrosion resistant, and the internal spring steel retention clip resists vibration and thermal cycling to securely hold the covers in place.

94830-02	1/4" (pkg. of 10).	\$43.95
Fits 1/4" socket head screws with hex drive (pkg. of 10).		
94832-02	5/16" (pkg. of 4).	\$24.95
Fits 5/16" socket head screws with hex drive (pkg. of 4).		

C. CHROME ALLEN® HOLE PLUGS

94130-93T	1/4" (pkg. of 10).	\$8.95
94131-93T	5/16" (pkg. of 10).	\$8.95
94132-93T	3/8" (pkg. of 10).	\$8.95

D. CHROME HEX BOLT COVERS

Place over a variety of exposed bolts for a cleaner, detailed look. Compression clips for a secure fit. Sold in packages of 6 covers with retaining clips.

43881-96	Fits 1/2" hex bolts.	\$19.95
-----------------	----------------------	----------------

E. CHROME AIR CLEANER SCREW

Complete the chrome on your stock air cleaner cover with this chrome-plated stainless steel screw, which easily replaces the polished stock air cleaner screw.

29703-00	Fits stock Evolution® 1340 engines.	\$6.95
-----------------	-------------------------------------	---------------

F. CHROME TIMER COVER SCREW KITS

Dress up accessory timer covers by replacing the stock zinc plate screws with brilliant chrome.

32690-99A	Fits Twin Cam 5-hole timer covers. Kit contains five chrome-plated button head Torx® screws.	\$17.95
94208-04	Fits '04-'22 XL, '18-later Softail® and '17-later Touring models.	\$7.95

G. CHROME DERBY COVER SCREW KIT

Dress up accessory derby covers by replacing the stock zinc-plated screws with brilliant chrome.

25913-99	Fits '99-later Dyna®, Softail, Touring and Trike models. Kit contains five chrome-plated button head Torx screws and five stainless steel washers.	\$19.95
-----------------	--	----------------

94630-98	Fits Evolution 1340 models. Kit includes three button head Torx screws and oil seals.	\$17.95
-----------------	---	----------------

94631-98	Fits '94-'03 XL models.	\$8.95
-----------------	-------------------------	---------------

94207-04	Fits '04-'22 XL models.	\$19.95
-----------------	-------------------------	----------------



B. CHROME SOCKET HEAD SCREW COVER KIT



C. CHROME ALLEN HOLE PLUGS



D. CHROME HEX BOLT COVERS



E. CHROME AIR CLEANER SCREW



F. CHROME TIMER COVER SCREW KIT – TWIN CAM SHOWN



G. CHROME DERBY COVER SCREW KIT – TWIN CAM SHOWN

Model Family Fitment:

■ V-ROD	■ SPORTSTER	■ DYNA
■ SOFTAIL	■ TOURING	

Notice: The prices appearing in this catalog are the manufacturer's suggested retail prices. Actual retail prices may vary.

462 ENGINE TRIM

Black Hardware Kits

A. BLACK HARDWARE KITS – ENGINE

Durable and easy to install, this gloss-black engine hardware adds a custom touch to the blacked-out look of your motorcycle. Kits include the hardware required to replace all of the visible zinc-plated fasteners on the vehicle's engine, primary, rocker boxes, derby or cam covers. Lock patch included where required.

BLACK HARDWARE KIT – FULL ENGINE

Includes the hardware required to replace the visible set of zinc-plated fasteners on the primary cover, derby cover, transmission side and top covers, tappet covers, cam covers and rocker box covers.

12600251 **\$278.95**

Fits '17-later Touring and Trike models.

12600256 **\$278.95**

Fits '18-later Softail® models. '18 models (except FLSB) require additional purchase of Derby Cover Kit P/N 12600255.

BLACK HARDWARE KIT – PRIMARY COVER

12600252 **\$58.95**

Fits '17-later Touring and Trike models.

12600257 **\$58.95**

Fits '18-later Softail models.

BLACK HARDWARE KIT – TRANSMISSION

12600253 **\$54.95**

Fits '18-later Softail and '17-later Touring and Trike models.

BLACK HARDWARE KIT – ROCKER BOX

12600254 **\$79.95**

Fits '18-later Softail and '17-later Touring and Trike models.

12600263 **\$74.95**

Fits '04-'22 XL models.

BLACK HARDWARE KIT – CAM COVER AND TAPPET COVERS

12600258 **\$33.95**

Fits '18-later Softail and '17-later Touring and Trike models.

BLACK HARDWARE KIT – DERBY COVER

12600259 **\$19.95**

Fits '19-later Softail and '18-later FLSB models.

12600255 **\$19.95**

Fits '06-'17 Dyna®, '08-'18 Softail (except FLSB) and '08-later Touring and Trike models.

Also available (not shown)

BLACK HARDWARE KIT – DERBY AND PRIMARY COVER

12600261 **\$74.95**

Fits '04-'22 XL models.



A. BLACK HARDWARE KITS – FULL ENGINE (12600251 SHOWN)



A. BLACK HARDWARE KIT – FULL ENGINE (12600251 SHOWN)



A. BLACK HARDWARE KIT – PRIMARY COVER (12600252 SHOWN)



A. BLACK HARDWARE KIT – TRANSMISSION (12600253 SHOWN)



A. BLACK HARDWARE KIT – ROCKER BOX (12600254 SHOWN)



A. BLACK HARDWARE KIT – CAM COVER AND TAPPET COVERS (12600258 SHOWN)



A. BLACK HARDWARE KIT – DERBY COVER (12600255 SHOWN)



B. CHROME HARDWARE KIT – PRIMARY COVER



C. CHROME HARDWARE KIT – GEARCASE/FRONT SPROCKET COVER



D. CHROME HARDWARE KIT – TRANSMISSION (SOFTAIL SHOWN)

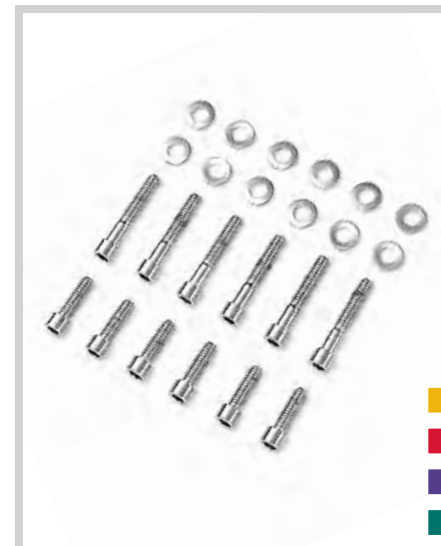

E. CHROME HARDWARE KIT – ROCKER BOX (BIG TWIN SHOWN)

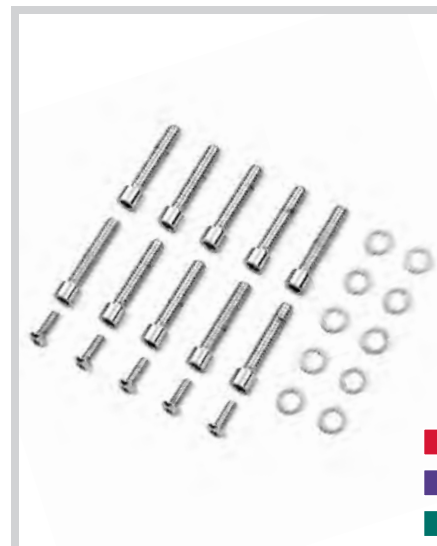

F. CHROME HARDWARE KIT – CAM COVER



G. CHROME HARDWARE KIT – LIFTER/TAPPET BLOCK

ENGINE TRIM 463

Chrome Hardware Kits

B. CHROME HARDWARE KIT – PRIMARY COVER

Kit includes the hardware required to replace the visible set of zinc-plated fasteners on the outer primary cover. Inspection and derby cover hardware included. Lock patch included where required.

94281-04 Fits '04-'22 XL models. **\$74.95**

C. CHROME HARDWARE KIT – GEARCASE/FRONT SPROCKET COVER

Kit includes the hardware required to replace the visible set of zinc-plated fasteners on the gearcase and front sprocket cover. Lock patch included where required.

94280-04 Fits '04-'22 XL models. **\$54.95**

D. CHROME HARDWARE KIT – TRANSMISSION

Kit includes the hardware required to replace the visible set of zinc-plated fasteners on the transmission top cover, bearing housing assembly and clutch release cover. Lock patch included where required.

94056-03 Fits '99-'05 Dyna® models. **\$64.95**

94055-03 Fits '00-'06 Softail® models. **\$64.95**

34856-06A **\$64.95**

Fits '06-'17 Dyna and '07-'17 Softail and Touring models.

E. CHROME HARDWARE KIT – ROCKER BOX

Kit includes the hardware required to replace the visible set of zinc-plated fasteners on rocker box covers. Lock patch included where required.

94291-04A Fits '04-'22 XL models. **\$40.95**

94059-03 **\$40.95**

Fits '99-'17 Dyna, '00-'17 Softail, and '99-'16 Touring and Trike models.

F. CHROME HARDWARE KIT – CAM COVER

Kit includes the hardware required to replace the visible set of zinc-plated fasteners on the cam cover. Cam position sensor cover hardware included. Lock patch included where required.

94058-03 **\$43.95**

Fits '99-'17 Dyna, '00-'17 Softail, and '99-'16 Touring and Trike models.

G. CHROME HARDWARE KIT – LIFTER/TAPPET BLOCK

Kit includes the hardware required to replace the visible set of zinc-plated fasteners on lifter block covers. Lock patch included where required.

94068-03 **\$27.95**

Fits '99-'17 Dyna, '00-'17 Softail, and '99-'16 Touring and Trike models.

Model Family Fitment:

V-ROD
 SPORTSTER
 DYNA
 SOFTAIL
 TOURING

Notice: The prices appearing in this catalog are the manufacturer's suggested retail prices. Actual retail prices may vary.

Notice: The prices appearing in this catalog are the manufacturer's suggested retail prices. Actual retail prices may vary.

464 ENGINE TRIM

Chrome Hardware

A. WINDSHIELD ACORN NUT KIT

Kit contains 10 chrome-plated low crown 12-24 acorn nuts.

94111-95 \$11.95

Fits Compact, King-Size, Convertible and Road King® windshields (pkg. of 10).

B. CHROME ACORN NUT KITS

94116-93T 10 - 32 thread (pkg. of 5). \$6.95

94117-93T 1/4" - 20 thread (pkg. of 5). \$6.95

94119-93T 5/16" - 18 thread (pkg. of 4). \$6.95

94120-93T 5/16" - 24 thread (pkg. of 4). \$6.95

94121-93T 3/8" - 16 thread (pkg. of 3). \$6.95

94122-93T 3/8" - 24 thread (pkg. of 3). \$6.95

94124-93T 7/16" - 20 thread (pkg. of 2). \$6.95

94125-93T 1/2" - 13 thread (pkg. of 1). \$7.95

94126-93T 1/2" - 20 thread (pkg. of 1). \$6.95

94127-93T 5/8" - 18 thread (pkg. of 1). \$6.95

C. CHROME TORX® BUTTON HEAD SCREWS

Available in 1/4-inch, 5/16-inch and 3/8-inch coarse thread, up to 2-1/4 inches long. Grade 8. See your Dealer for more information.

D. CHROME HEX SOCKET BUTTON HEAD SCREWS

Available in 8-32, 10-24, 10-32, 1/4-inch, 5/16-inch and 3/8-inch, up to 1 inch long. See your Dealer for more information.

E. CHROME TORX SOCKET HEAD SCREWS

Available in 1/4-inch, 5/16-inch and 3/8-inch coarse thread, up to 2-1/4 inches long. Grade 8. See your Dealer for more information.

F. CHROME SOCKET HEAD SCREWS

Available in 1/4-inch, 5/16-inch and 3/8-inch coarse and fine thread, up to 3 inches long. See your Dealer for more information.



A. WINDSHIELD ACORN NUT KIT



B. CHROME ACORN NUT KITS



C. CHROME TORX BUTTON HEAD SCREWS



D. CHROME HEX SOCKET BUTTON HEAD SCREWS



E. CHROME TORX SOCKET HEAD SCREWS



F. CHROME SOCKET HEAD SCREWS



G. CHROME SMOOTH SOCKET HEAD SCREWS



H. CHROME HEX HEAD SCREWS



I. CHROME 12-POINT SCREWS



J. CHROME FLAT-HEAD SCREWS



K. CHROME LOCK NUTS WITH NYLON INSERTS



L. CHROME HEX NUTS



M. CHROME FLAT WASHERS



N. CHROME LOCK WASHERS

ENGINE TRIM 465

Chrome Hardware

G. CHROME SMOOTH SOCKET HEAD SCREWS

Available in 1/4-inch, 5/16-inch and 3/8-inch coarse and fine thread, up to 3 inches long. See your Dealer for more information.

H. CHROME HEX HEAD SCREWS

Available in 1/4-inch, 5/16-inch and 3/8-inch coarse and fine thread, up to 3 inches long. See your Dealer for more information.

I. CHROME 12-POINT SCREWS

Available in 1/4-inch, 5/16-inch and 3/8-inch coarse thread, up to 2-1/4 inches long. Grade 8. See your Dealer for more information.

J. CHROME FLAT-HEAD SCREWS

When the details matter, even your screws are chromed. These Grade 8 Hex Drive screws are available in 17 different sizes. See your Dealer for more information.

K. CHROME LOCK NUTS WITH NYLON INSERTS

Available in 10-24, 1/4-inch, 5/16-inch, 3/8-inch, 7/16-inch and 5/8-inch sizes, coarse and fine thread. See your Dealer for more information.

L. CHROME HEX NUTS

Available in 1/4-inch, 5/16-inch and 3/8-inch sizes, coarse and fine thread. See your Dealer for more information.

M. CHROME FLAT WASHERS

Available in 1/4-inch, 5/16-inch and 3/8-inch sizes. See your Dealer for more information.

N. CHROME LOCK WASHERS

Available in 1/4-inch, 5/16-inch and 3/8-inch sizes. See your Dealer for more information.

Model Family Fitment:

- V-ROD
- SPORTSTER
- DYNA
- SOFTAIL
- TOURING

Notice: The prices appearing in this catalog are the manufacturer's suggested retail prices. Actual retail prices may vary.

Notice: The prices appearing in this catalog are the manufacturer's suggested retail prices. Actual retail prices may vary.



Ultra Limited - Chrome Switch Housings

HARLEY-DAVIDSON®

CONTROLS

The most visual contact point you have with your motorcycle is where your hands and feet meet the controls. Choose a handlebar suitable for your physical needs. Then select grips, hand controls, footpegs and mirrors to underscore the style of your ride.

468 CONTROLS

Hand & Foot Controls Collection

ADVERSARY™ COLLECTION — ANODIZED BLACK WITH ORANGE HIGHLIGHTS

A look to match your riding style – precise, refined and technical. Premium Adversary™ Collection accessories are crafted in forged billet aluminum with a durable dual-anodized black and orange finish for crisp contrast and colorful detail. The look is aggressive, and performance driven. Step up to the next generation of customization.

A. ADVERSARY COLLECTION HAND GRIPS — BLACK WITH ORANGE HIGHLIGHTS

56100544 **\$149.95**

Fits '16-'17 FXDLS and '16-later Softail® models, '11-'12 FLSTSE, '14-'15 FLSTNSE, '13-'14 FXSBSE, '16-'17 FXSE and '08-later Touring (except '18-later FLTRXSE) and Trike models.

56100448 **\$129.95**

Fits '21-later Revolution® Max engine-equipped models. Requires separate purchase of Endcaps (Qty 2). Models with Bar End Mirrors require separate purchase of P/N 55801095 qty (2). Does not fit models with original equipment heated grips.

B. ADVERSARY COLLECTION FOOTBOARDS — BLACK WITH ORANGE HIGHLIGHTS

50502251 Rider. **\$439.95**

Fits '12-'16 FLD, '86-'17 FL Softail (except FLS, FLSS, FLSTFB, FLSTFBS and FXSE), '86-later Touring (except FLHTCUL and FLHTKL) and '08-later Trike models.

50502256 Rider. **\$439.95**

Fits '18-later FL Softail models equipped with rider footboards.

C. ADVERSARY COLLECTION BRAKE PEDAL PADS — BLACK WITH ORANGE HIGHLIGHTS

50600510 Small. **\$64.95**

Fits '18-later FL SB, FXBR and FXBRS models. Also fits '18-later Softail® models equipped with Billet Style Rear Brake Lever for Forward Controls P/N 41600218, 41600219 and 41600220.

50600511 Large. **\$74.95**

Fits '12-'16 FLD, '86-'17 FL Softail® and '80-later Touring and Trike models.

50600508 Large. **\$74.95**

Fits '18-later FL Softail® models equipped with rider footboards.

D. ADVERSARY COLLECTION FOOTPEGS — BLACK WITH ORANGE HIGHLIGHTS

50502254 Rider. **\$129.95**

Fits rider position on '22-later RH975 and '23-later RH975S models. Does not fit with accessory Forward Controls P/N 50502205.

50502255 Rider. **\$129.95**

Fits rider position on '21-later RH1250S models.

50502248 Passenger. **\$159.95**

Fits passenger position on '20 LiveWire® and '18-later Softail models.

50502246 Passenger. **\$159.95**

Fits passenger position on '10-later FLHX, FLHXS, FLHXST, FLHXSE, FLTRX, FLTRXS, FLTRXST, and FLTRXSE models.

50501979 Passenger. **\$129.95**

Fits '21-later Revolution® Max engine-equipped models.

50502249 Highway. **\$159.95**

Fits models using highway peg mounts and engine guard peg mounts P/N 50957-02C, 54234-10A, 50829-07A, 50830-07A, 50500167, 50500168, 50832-07A and 50964-98. Does not fit '18-later FXDRS models.

E. ADVERSARY COLLECTION SHIFTER PEG — BLACK WITH ORANGE HIGHLIGHTS

33600384 **\$54.95**

Fits all models (except Revolution Max engine-equipped models, '06-'17 VRSC™ models with forward controls and '08-'13 XR models).

33600321 **\$49.95**

Fits '21-later Revolution® Max engine-equipped models.



A. ADVERSARY COLLECTION HAND GRIPS — BLACK WITH ORANGE HIGHLIGHTS



F. ADVERSARY COLLECTION HAND GRIPS — GRAPHITE WITH MACHINED HIGHLIGHTS



B. ADVERSARY COLLECTION FOOTBOARDS — BLACK WITH ORANGE HIGHLIGHTS



G. ADVERSARY COLLECTION FOOTBOARDS — GRAPHITE WITH MACHINED HIGHLIGHTS



C. ADVERSARY COLLECTION BRAKE PEDAL PADS — BLACK WITH ORANGE HIGHLIGHTS



D. ADVERSARY COLLECTION FOOTPEGS — BLACK WITH ORANGE HIGHLIGHTS



H. ADVERSARY COLLECTION BRAKE PEDAL PADS — GRAPHITE WITH MACHINED HIGHLIGHTS



I. ADVERSARY COLLECTION FOOTPEGS — GRAPHITE WITH MACHINED HIGHLIGHTS



E. ADVERSARY COLLECTION SHIFTER PEG — BLACK WITH ORANGE HIGHLIGHTS



J. ADVERSARY COLLECTION SHIFTER PEG — GRAPHITE WITH MACHINED HIGHLIGHTS

CONTROLS 469

Hand & Foot Controls Collection

ADVERSARY™ COLLECTION — GRAPHITE WITH MACHINED HIGHLIGHTS

A look to match your riding style – precise, refined and technical. Premium Adversary™ Collection accessories are crafted in forged billet aluminum. The graphite finish with machined highlights reveal brilliant aluminum for crisp contrast and sharp detail. The look is aggressive and performance driven. Step up to the next generation of customization.

F. ADVERSARY COLLECTION HAND GRIPS — GRAPHITE WITH MACHINED HIGHLIGHTS

56100545 **\$139.95**

Fits '16-'17 FXDLS and '16-later Softail® models, '11-'12 FLSTSE, '14-'15 FLSTNSE, '13-'14 FXSBSE, '16-'17 FXSE and '08-later Touring (except '18-later FLTRXSE) and Trike models.

56100449 **\$119.95**

Fits '21-later Revolution® Max engine-equipped models. Requires separate purchase of Endcaps (Qty 2). Models with Bar End Mirrors require separate purchase of P/N 55801095 qty (2). Does not fit models with original equipment heated grips.

G. ADVERSARY COLLECTION FOOTBOARDS — GRAPHITE WITH MACHINED HIGHLIGHTS

50502250 Rider. **\$429.95**

Fits '12-'16 FLD, '86-'17 FL Softail (except FLS, FLSS, FLSTFB, FLSTFBS and FXSE), '86-later Touring (except FLHTCUL and FLHTKL) and '08-later Trike models.

50502257 Rider. **\$429.95**

Fits '18-later FL Softail models equipped with rider footboards.

H. ADVERSARY COLLECTION BRAKE PEDAL PADS — GRAPHITE WITH MACHINED HIGHLIGHTS

50600509 Small. **\$59.95**

Fits '18-later FL SB, FXBR and FXBRS models. Also fits '18-later Softail® models equipped with Billet Style Rear Brake Lever for Forward Controls P/N 41600218, 41600219 and 41600220.

50600512 Large. **\$69.95**

Fits '12-'16 FLD, '86-'17 FL Softail® and '80-later Touring and Trike models.

50600507 Large. **\$69.95**

Fits '18-later FL Softail® models equipped with rider footboards.

I. ADVERSARY COLLECTION FOOTPEGS — GRAPHITE WITH MACHINED HIGHLIGHTS

50502252 Rider. **\$119.95**

Fits rider position on '22-later RH975 and '23-later RH975S models. Does not fit with accessory Forward Controls P/N 50502205.

50502253 Rider. **\$119.95**

Fits rider position on '21-later RH1250S models.

50502247 Passenger. **\$149.95**

Fits passenger position on '20 LiveWire® and '18-later Softail models.

50502245 Passenger. **\$149.95**

Fits passenger position on '10-later FLHX, FLHXS, FLHXST, FLHXSE, FLTRX, FLTRXS, FLTRXST, and FLTRXSE models.

50501980 Passenger. **\$119.95**

Fits '21-later Revolution® Max engine-equipped models.

50502244 Highway. **\$149.95**

Fits models using highway peg mounts and engine guard peg mounts P/N 50957-02C, 54234-10A, 50829-07A, 50830-07A, 50500167, 50500168, 50832-07A and 50964-98. Does not fit '18-later FXDRS models.

J. ADVERSARY COLLECTION SHIFTER PEG — GRAPHITE WITH MACHINED HIGHLIGHTS

33600383 **\$49.95**

Fits all models (except Revolution Max engine-equipped models, '06-'17 VRSC™ models with forward controls and '08-'13 XR models).

33600322 **\$39.95**

Fits '21-later Revolution® Max engine-equipped models.

Notice: The prices appearing in this catalog are the manufacturer's suggested retail prices. Actual retail prices may vary.

Notice: The prices appearing in this catalog are the manufacturer's suggested retail prices. Actual retail prices may vary.

470 CONTROLS

Hand & Foot Controls Collection

'66 COLLECTION

The look is timeless and authentic. The handcrafted style of the '66 Collection accessories combines a durable gloss black finish with brushed aluminum highlights and on most pieces a brass-colored medallion inspired by a classic Harley-Davidson® tank emblem. Here's an alternative to bright chrome or blacked out styles that will set your bike apart from the crowd.

A. '66 COLLECTION HAND GRIPS

56100478 \$119.95
Fits '16-'17 FXDLS and '16-later Softail® models, '11-'12 FLSTSE, '14-'15 FLSTNSE, '13-'14 FXSBSE, '16-'17 FXSE and '08-later Touring (except '18-later FLTRXSE) and Trike models.

56100477 \$119.95
Fits '21-later Revolution® Max engine-equipped models. Requires separate purchase of Endcaps (Qty 2). Models with Bar End Mirrors require separate purchase of P/N 55801095 qty (2). Does not fit models with original equipment heated grips.

B. '66 COLLECTION BRAKE PEDAL PAD

50600483 Small. \$69.95
Fits '21-later RH1250S and RH975 models. RH1250S models require the separate purchase of lever P/N 41600348, and RH975 models require separate purchase of lever P/N 416000370.

50600499 Small. \$59.95
Fits '18-later FXBR, FXBRS and FLSB models. Also fits '18-later Softail® models equipped with Billet Style Rear Brake Lever for Forward Controls P/N 41600218, 41600219 and 41600220.

C. '66 COLLECTION FOOTPEGS

50502148 Rider. \$149.95
Fits '18-later FXFB, FXFBS, FXDRS, and '22-later RH975 and RH975S models.

50502149 Rider. \$149.95
Fits '18-later FXBB, FXST, FXLR, FXLRS, and '21-later RH1250S models.

50502150 Rider. \$149.95
Fits '18-later FLSB, FXBR and FXBRS models.

50502151 Passenger. \$149.95
Fits passenger position on '20-later LiveWire®, '18-later Softail models and '21-later Revolution Max engine-equipped models.

D. '66 COLLECTION SHIFTER PEG

33600357 \$49.95
Fits all models (except Revolution Max engine-equipped models, 06-17 VRSC™ models with forward controls and 08-13 XR models).

33600356 \$49.95
Fits '21-later Revolution® Max engine-equipped models.

E. '66 COLLECTION REAR BRAKE LEVER

41600370 \$99.95
Fits '22-later RH975 models. Requires separate purchase of brake pedal pad P/N 50600483.

41600348 \$99.95
Fits '21-later RH1250S models. Requires separate purchase of brake pedal pad P/N 50600483.



A. '66 COLLECTION HAND GRIPS



B. '66 COLLECTION BRAKE PEDAL PAD



C. '66 COLLECTION FOOTPEGS



D. '66 COLLECTION SHIFTER PEG



F. WILD ONE COLLECTION HAND GRIPS



G. WILD ONE COLLECTION FOOTPEGS



H. WILD ONE COLLECTION SHIFTER PEG



E. '66 COLLECTION REAR BRAKE LEVER



I. WILD ONE COLLECTION REAR BRAKE LEVER



CONTROLS 471

Hand & Foot Controls Collection

WILD ONE™ COLLECTION

Add daring, raw-and-rugged style with durable billet aluminum Wild One™ Collection accessories. Each is finished in gloss black with bright, machined aluminum highlights, a variety of textures and exposed hardware to communicate power, speed, and performance.

F. WILD ONE COLLECTION HAND GRIPS

56100462 Non-Heated. \$138.95
Fits '21-later RA1250 and RH1250S models. Requires separate purchase of Endcaps P/N 55801095 (Qty 2). Does not fit models with original equipment heated grips.

56100483 Heated. \$244.95
Fits '21-later RA1250S, RH1250S and RH975S models. RH1250S and RH975S models require a Digital Technician™ update by a Harley-Davidson® dealer.

G. WILD ONE COLLECTION FOOTPEGS

50502020 Rider. \$158.95
Fits '21-later RH1250S models.

50502026 Passenger. \$158.95
Fits passenger position on '21-later Revolution® Max engine-equipped models.

H. WILD ONE COLLECTION SHIFTER PEG

33600338 \$53.95
Fits '21-later RH1250S models.

I. WILD ONE COLLECTION REAR BRAKE LEVER

41600326 \$104.95
Fits '21-later RH1250S models.

CONTROLS

472 CONTROLS

Hand & Foot Controls Collection

EMPIRE™ COLLECTION - BLACK MACHINE CUT

Raise the stakes. Milled highlights reveal gleaming billet aluminum below the rich black anodized surface, while deep grooves add eye-catching depth and detail to each component in this complete collection of hand and foot controls. Executed in durable cast and billet aluminum, the Black Machine Cut Empire™ Collection adds captivating custom detail that complements black or machine cut accessories.

A. EMPIRE COLLECTION HAND GRIPS – BLACK MACHINE CUT

56100429 Rider. **\$159.95**

Fits '20-later LiveWire®, '16-'17 Dyna® FXDLS and '16-later Softail® models, '11-'12 FLSTSE, '14-'15 FLSTNSE, '13-'14 FXSBSE, '16-'17 FXSE and '08-later Touring (except '18-later FLTRXSE) and Trike models.

56100447 Passenger. **\$159.95**

Fits '21-later Revolution® Max engine-equipped models. Does not fit models with original equipment heated grips.

B. EMPIRE COLLECTION FOOTBOARDS – BLACK MACHINE CUT

50501934 Rider. **\$504.95**

Fits '12-'16 FLD, '00-'17 FL Softail®, '00-later Touring (except FLHTCUL and FLHTKL), and '09-'13 Trike models. Installation on '00-'17 Softail® FLS, FLSS, FLSTFB, FLSTFBS and FLSTN models requires separate purchase of Jiffy Stand P/N 50087-07A. Not for use with Ergo Jiffy Stand P/N 50000091 or Jiffy Stand Extension Kit P/N 50233-00, 50000008 or 500000023.

50501939 Passenger. **\$504.95**

Fits '18-later FL Softail models equipped with rider footboards.

50501952 Passenger. **\$388.95**

Fits '06-'17 Dyna®, '00-'17 Softail and '86-later Touring models equipped with passenger footboard support. Does not fit Trike Models.

C. EMPIRE COLLECTION BRAKE PEDAL PADS – BLACK MACHINE CUT

50600457 Small. **\$63.95**

Fits '15-'20 XG models (except XG750A), '14-'22 XL models with Extended Reach Forward Control Kit P/N 50700030, '93-'17 Dyna® models with forward controls, and '84-'17 FX Softail® models (except FXSTDSE). Also fits '18-later FXBR, FXBRS, FLSB models and '18-later Softail® models equipped with Billet Style Rear Brake Lever for Forward Controls P/N 41600218, 41600219 and 41600220

50600518 Small. **\$63.95**

Fits '21-later RH1250S and RH975 models. RH1250S models require the separate purchase of lever P/N 41600348, and RH975 models require separate purchase of lever P/N 416000370.

50600463 Large. **\$83.95**

Fits '12-'16 FLD, '86-'17 FL Softail and '80-later Touring and Trike models.

50600466 Large. **\$83.95**

Fits '18-later FL Softail® models equipped with rider footboards.



A. EMPIRE HAND GRIPS – MACHINE CUT



A. EMPIRE HAND GRIPS – MACHINE CUT



A. EMPIRE HAND GRIPS – MACHINE CUT



B. EMPIRE FOOTBOARD – MACHINE CUT RIDER



B. EMPIRE FOOTBOARD – MACHINE CUT PASSENGER



C. EMPIRE BRAKE PEDAL PADS – MACHINE CUT – SMALL



C. EMPIRE BRAKE PEDAL PADS – MACHINE CUT – LARGE



D. EMPIRE RIDER FOOTPEGS – MACHINE CUT



D. EMPIRE PASSENGER FOOTPEGS – MACHINE CUT



D. EMPIRE PASSENGER FOOTPEGS – MACHINE CUT



E. EMPIRE SHIFTER PEG – MACHINE CUT



E. EMPIRE SHIFTER PEG – MACHINE CUT

CONTROLS 473

Hand & Foot Controls Collection

D. EMPIRE™ COLLECTION FOOTPEGS – BLACK MACHINE CUT

50501900 Rider. **\$168.95**
Fits '18-later FXFB, FXFBS, and '19-'20 FXDRS models in the rider position.

50501857 Rider. **\$168.95**
Fits rider position on '22-later RH1250S and '18-later FLSB, FXBB, FXBBS, FXLR, FXLRS, FXBR, FXBRS, and FXST models.

50502339 Passenger. **\$168.95**
Fits rider position on '22-later RH975 and '23-later RH975S models. Does not fit with accessory Forward Controls P/N 50502205.

50501832 Passenger. **\$168.95**
Fits '18-later Softail® models in the passenger position.

50502113 Passenger. **\$168.95**
Fits passenger position on '10-later FLHX, FLHXS, FLHXST, FLHXSE, FLTRX, FLTRXS, FLTRXST, and FLTRXSE models.

50502354 Passenger. **\$168.95**
Fits passenger position on '21-later RH1250S and '22-later RH975 and RH975S models. RH1250S models require separate purchase of Passenger Footpeg Mount Kit P/N 50502192A. RH975 models require separate purchase of Passenger Footpeg Mount Kit P/N50502434.

50501897 Highway. **\$168.95**
Fits models using highway peg mounts and engine guard peg mounts P/N 50957-02C, 54234-10A, 50829-07A, 50830-07A, 50500167, 50500168, 50832-07A and 50964-98.

E. EMPIRE COLLECTION SHIFTER PEG – BLACK MACHINE CUT

33600333 **\$53.95**
Fits all models (except '06-'17 VRSC™ models with forward controls and '08-'13 XR models).

33600393 **\$53.95**
Fits all models (except '06-'17 VRSC™ models with forward controls and '08-'13 XR models).

Model Family Fitment:

- V-ROD
- SPORTSTER
- DYNA
- SOFTAIL
- TOURING

Notice: The prices appearing in this catalog are the manufacturer's suggested retail prices. Actual retail prices may vary.

Notice: The prices appearing in this catalog are the manufacturer's suggested retail prices. Actual retail prices may vary.

CONTROLS

474 CONTROLS

Hand & Foot Controls Collection

EMPIRE™ COLLECTION – BLACK

Raise the stakes. Deep grooves add eye-catching depth and detail to the rich black anodized finish on this complete collection of hand and foot controls. Executed in durable cast and billet aluminum, the Black Empire™ Collection adds captivating custom detail that complements other black and machine cut accessories.

A. EMPIRE COLLECTION HAND GRIPS – BLACK

56100428 Rider. **\$149.95**
Fits '20-later LiveWire®, '16-'17 Dyna® FXDLS and '16-later Softail® models, '11-'12 FLSTSE, '14-'15 FLSTNSE, '13-'14 FXSBSE, '16-'17 FXSE and '08-later Touring (except '18-later FLTRXSE) and Trike models.

56100446 Rider. **\$149.95**
Fits '21-later Revolution® Max engine-equipped models. Does not fit models with original equipment heated grips.

B. EMPIRE COLLECTION FOOTBOARDS – BLACK

50501933 Rider. **\$473.95**
Fits '12-'16 FLD, '00-'17 FL Softail®, '00-later Touring (except FLHTCUL and FLHTKL), and '09-'13 Trike models. Installation on '00-'17 Softail® FLS, FLSS, FLSTFB, FLSTFBS and FLSTN models requires separate purchase of Jiffy Stand P/N 50087-07A. Not for use with Ergo Jiffy Stand P/N 50000091 or Jiffy Stand Extension Kit P/N 50233-00, 50000008 or 50000023.

50501938 Rider. **\$473.95**
Fits '18-later FL Softail models equipped with rider footboards.

50501951 Passenger. **\$357.95**
Fits '06-'17 Dyna®, '00-'17 Softail and '86-later Touring models equipped with passenger footboard support. Does not fit Trike Models.

C. EMPIRE COLLECTION BRAKE PEDAL PADS – BLACK

50600458 Small. **\$58.95**
Fits '15-'20 XG models (except XG750A), '14-'22 XL models with Extended Reach Forward Control Kit P/N 50700030, '93-'17 Dyna® models with forward controls, and '84-'17 FX Softail® models (except FXSTDSE). Also fits '18-later FXBR, FXBRS, FLSB models and '18-later Softail® models equipped with Billet Style Rear Brake Lever for Forward Controls P/N 41600218, 41600219 and 41600220

50600517 Small. **\$57.95**
Fits '21-later RH1250S and RH975 models. RH1250S models require the separate purchase of lever P/N 41600348, and RH975 models require separate purchase of lever P/N 41600370.

50600464 Large. **\$78.95**
Fits '12-'16 FLD, '86-'17 FL Softail and '80-later Touring and Trike models.

50600467 Large. **\$78.95**
Fits '18-later FL Softail® models equipped with rider footboards.



A. EMPIRE HAND GRIPS – BLACK



A. EMPIRE HAND GRIPS – BLACK



A. EMPIRE HAND GRIPS – BLACK



B. EMPIRE FOOTBOARD – BLACK RIDER



B. EMPIRE FOOTBOARD – BLACK PASSENGER



C. EMPIRE BRAKE PEDAL PADS – BLACK SMALL



C. EMPIRE BRAKE PEDAL PADS – BLACK LARGE



D. EMPIRE RIDER FOOTPEGS – BLACK



D. EMPIRE RIDER FOOTPEGS – BLACK



D. EMPIRE PASSENGER FOOTPEGS – BLACK



D. EMPIRE PASSENGER FOOTPEGS – BLACK



E. EMPIRE SHIFTER PEG – BLACK

CONTROLS 475

Hand & Foot Controls Collection

D. EMPIRE™ COLLECTION FOOTPEGS – BLACK

50501899 Rider. **\$158.95**
Fits '18-later FXFB, FXFBS, and '19-'20 FXDRS models in the rider position.

50501856 Rider. **\$158.95**
Fits rider position on '22-later RH1250S and '18-later FLSB, FXBB, FXBBS, FXLR, FXLRS, FXBR, FXBRS, and FXST models.

50502338 Rider. **\$158.95**
Fits rider position on '22-later RH975 and '23-later RH975S models. Does not fit with accessory Forward Controls P/N 50502205.

50501831 Passenger. **\$158.95**
Fits '18-later Softail® models in the passenger position.

50502112 Passenger. **\$158.95**
Fits passenger position on '10-later FLHX, FLHXS, FLHXST, FLHXSE, FLTRX, FLTRXS, FLTRXST, and FLTRXSE models.

50502353 Passenger. **\$158.95**
Fits passenger position on '21-later RH1250S and '22-later RH975 and RH975S models. RH1250S models require separate purchase of Passenger Footpeg Mount Kit P/N 50502192A. RH975 models require separate purchase of Passenger Footpeg Mount Kit P/N50502434.

50501896 Highway. **\$158.95**
Fits models using highway peg mounts and engine guard peg mounts P/N 50957-02C, 54234-10A, 50829-07A, 50830-07A, 50500167, 50500168, 50832-07A and 50964-98.

E. EMPIRE COLLECTION SHIFTER PEG – BLACK

33600334 **\$47.95**
Fits all models (except '06-'17 VRSC™ models with forward controls and '08-'13 XR models).

33600392 **\$47.95**
Fits all models (except '06-'17 VRSC™ models with forward controls and '08-'13 XR models).

Model Family Fitment:

V-ROD
 SPORTSTER
 DYNA
 SOFTAIL
 TOURING

Notice: The prices appearing in this catalog are the manufacturer's suggested retail prices. Actual retail prices may vary.

Notice: The prices appearing in this catalog are the manufacturer's suggested retail prices. Actual retail prices may vary.

CONTROLS

476 CONTROLS

Hand & Foot Controls Collection

EMPIRE™ COLLECTION - CHROME

Raise the stakes. Brilliant chrome highlights the deep grooves that add eye-catching depth and detail to this complete collection of hand and foot controls. Executed in durable cast and billet aluminum, the Chrome Empire™ Collection adds captivating custom detail that complements other chrome accessories.

A. EMPIRE COLLECTION HAND GRIPS – CHROME

56100427 **\$149.95**
Fits '20-later LiveWire®, '16-'17 Dyna® FXDLS and '16-later Softail® models, '11-'12 FLSTSE, '14-'15 FLSTNSE, '13-'14 FXSBSE, '16-'17 FXSE and '08-later Touring (except '18-later FLTRXSE) and Trike models.



A. EMPIRE HAND GRIPS – CHROME

B. EMPIRE COLLECTION FOOTBOARDS – CHROME

50501932 Rider. **\$473.95**
Fits '12-'16 FLD, '00-'17 FL Softail®, '00-later Touring (except FLHTCUL and FLHTKL), and '09-'13 Trike models. Installation on '00-'17 Softail® FLS, FLSS, FLSTFB, FLSTFBS and FLSTN models requires separate purchase of Jiffy Stand P/N 50087-07A. Not for use with Ergo Jiffy Stand P/N 50000091 or Jiffy Stand Extension Kit P/N 50233-00, 50000008 or 50000023.

50501945 Rider. **\$473.95**
Fits '18-later FL Softail models equipped with rider footboards.

50501950 Passenger. **\$357.95**
Fits '06-'17 Dyna®, '00-'17 Softail and '86-later Touring models equipped with passenger footboard support. Does not fit Trike Models.



B. EMPIRE RIDER FOOTBOARD – CHROME



B. EMPIRE PASSENGER FOOTBOARD – CHROME

C. EMPIRE COLLECTION BRAKE PEDAL PADS – CHROME

50600459 Small. **\$58.95**
Fits '15-'20 XG models (except XG750A), '14-'22 XL models with Extended Reach Forward Control Kit P/N 50700030, '93-'17 Dyna® models with forward controls, and '84-'17 FX Softail® models (except FXSTDSE). Also fits '18-later FXBR, FXBRS, FLSB models and '18-later Softail® models equipped with Billet Style Rear Brake Lever for Forward Controls P/N 41600218, 41600219 and 41600220.

50600465 Large. **\$78.95**
Fits '12-'16 FLD, '86-'17 FL Softail and '80-later Touring and Trike models.

50600468 Large. **\$78.95**
Fits '18-later FL Softail® models equipped with rider footboards.



C. EMPIRE BRAKE PEDAL PADS – CHROME

D. EMPIRE COLLECTION FOOTPEGS – CHROME

50501898 Rider. **\$158.95**
Fits '18-later FXFB, FXFBS, and '19-'20 FXDRS models in the rider position.

50501855 Rider. **\$158.95**
Fits rider position on '22-later RH1250S and '18-later FLSB, FXBB, FXBBS, FXLR, FXLRS, FXBR, FXBRS, and FXST models.

50501830 Passenger. **\$158.95**
Fits '18-later Softail® models in the passenger position.

50502111 Passenger. **\$158.95**
Fits passenger position on '10-later FLHX, FLHXS, FLHXST, FLHXSE, FLTRX, FLTRXS, FLTRXST, and FLTRXSE.

50501895 Highway. **\$158.95**
Fits models using highway peg mounts and engine guard peg mounts P/N 50957-02C, 54234-10A, 50829-07A, 50830-07A, 50500167, 50500168, 50832-07A and 50964-98.



D. EMPIRE PASSENGER FOOTPEGS – CHROME



D. EMPIRE RIDER FOOTPEGS – CHROME

E. EMPIRE COLLECTION SHIFTER PEG – CHROME

33600335 **\$47.95**
Fits all models (except '06-'17 VRSC™ models with forward controls and '08-'13 XR models).

Fits all models (except '06-'17 VRSC™ models with forward controls and '08-'13 XR models).



E. EMPIRE SHIFTER PEG – CHROME



F. 80GRIT RIDER FOOTBOARDS



G. 80GRIT BRAKE PEDAL PAD



H. 80GRIT RIDER FOOTPEGS – BLACK



H. 80GRIT RIDER FOOTPEGS – RAW



H. 80GRIT PASSENGER FOOTPEGS – BLACK



H. 80GRIT PASSENGER FOOTPEGS – RAW

CONTROLS 477

Hand & Foot Controls Collection

F. 80GRIT™ RIDER FOOTBOARDS

When the road bites, bite back. With durable cast aluminum and rugged style edges this BMX-inspired footboard grips your boot for unmatched stability and traction, giving you the confidence to ride as hard as you like.

Fits '14-later Touring models.

50501602	Raw.	\$437.95
50501604	Black.	\$437.95

Fits '18-later FL Softail® models equipped with rider footboards.

50501612	Raw.	\$437.95
50501613	Black.	\$437.95

G. 80GRIT BRAKE PEDAL PAD

This BMX-inspired brake pedal pad features rugged styled edges for superior grip and a bold, stripped-down look.

Fits '18-later FLSL, FLDE, FLFB, FLFBS, FLHC, and FLHCS models equipped with Endgame Brake Lever P/N 41600299 or 41600298 and '14-later Touring models equipped with Endgame Brake Lever P/N 41600305 or P/N 41600304.

50600425	Raw.	\$69.95
50600424	Black.	\$69.95

H. 80GRIT™ FOOTPEGS

Combine form and function with the feel of an old-school BMX-style footpeg. The aluminum material with rugged styled edges is lightweight and grips the bottom of your boot, giving you an unmatched feeling of confidence. Black Anodized or Raw finishes provide custom options, while the HDMC "dog tag"-style logo adds subtle authenticity to the bold, stripped-down look.

Rider

Fits rider position on '20-later LiveWire®, '18-later FXFB, FXFBS, '19-later FXDRS models and '21-later RA1250 and RA1250S models.

50501383	Black.	\$191.95
50501390	Raw.	\$191.95

Rider with Wear Peg

Fits '11-'22 XL883L and XL1200C, '16-'22 XL1200CX, '12-'16 XL1200V, '10-'22 XL1200X, '18-'22 XL1200XS, '14-'22 XL models equipped with Extended Reach Forward Control Conversion Kit P/N 50700030, '08-'11 FXCW and FXCWC and '11-'17 FXS and FXSB and '16-'17 FXSE. Does not fit '15-later XG models.

50501387	Black.	\$191.95
50501394	Raw.	\$191.95

Fits '17-'20 XG750A and '09-'22 XL883N models.

50501385	Black.	\$191.95
50501392	Raw.	\$191.95

Fits rider position on '18-later FLSB, FXBB, FXBBS, FXBR, FXBRS, FXLR, FXLRS and FXST models. Also fits '18 later FLDE, FLHC, FLHCS, FLSL, FLFB and FLFBS models equipped with Footboard To Footpeg Conversion Kit P/N 50501640 and '09-later Touring models equipped with Board-To-Peg Conversion Kit P/N 50501642.

50501382	Black.	\$191.95
50501389	Raw.	\$191.95

Passenger

Fits passenger position on '20-later LiveWire, '18-later Softail® models (except '22-later FXLRST) and '21-later Revolution® Max engine-equipped models.

50501388A	Black.	\$191.95
50501395A	Raw.	\$191.95

Fits models in passenger and highway peg positions. Does not fit the rider and passenger position for '18-later Softail models.

50501603	Raw.	\$180.95
50501605	Black.	\$180.95

Model Family Fitment:

	V-ROD		SPORTSTER		DYNA
	SOFTAIL		TOURING		

Notice: The prices appearing in this catalog are the manufacturer's suggested retail prices. Actual retail prices may vary.

Notice: The prices appearing in this catalog are the manufacturer's suggested retail prices. Actual retail prices may vary.

478 CONTROLS

Hand & Foot Controls Collection

ENDGAME COLLECTION - BLACK

Push your custom style to the edge. The Endgame collection is defined by its slotted design and high-tech, industrial look. The intense black rubber and matte black finish gives you a powerful new way to highlight your high-performance machine.

A. ENDGAME COLLECTION HAND GRIPS – BLACK ANODIZED

Featuring raised black rubber inserts with a black surround, these 1.5" diameter grips deliver superior control and tough industrial styling. Easy-to-install glueless design allows you to remove grips for service without damage.

56100394 **\$149.95**

Fits '20-later LiveWire®, '16-'17 Dyna® FXDLS and '16-later Softail® models, '14-'15 FLSTNSE, '11-'12 FLSTSE, '13-'14 FXSBSE, and '08-later Touring (except '18-later FLTRXSE) and Trike models.

B. ENDGAME COLLECTION FOOTPEGS – BLACK ANODIZED

Finish off the high-tech, industrial look with Endgame Footpegs. Kit includes slotted left and right footpegs with raised diamond-tread rubber grips to help keep your foot firmly in place.

50501684 Rider. **\$149.95**

Fits '18-later FL SB, FXBB, FXBBS, FXBR, FXBRS, FXLR and FXLRS models.

50501644 Passenger. **\$149.95**

Fits passenger position on '20-later LiveWire® and '18-later Softail models.

50501716 **\$149.95**

Fits models with H-D® male mount style footpeg supports (except the rider position on '15-later XG, '07-'10 XL883L, '07-'22 XL883N, XL1200N, XL1200V and XL1200X, '11-'22 XL1200C and XL1200T, '18-'22 XL1200NS and XL1200XS, '08-'13 XR and '08-'17 FXCW, FXCWC, FXS, FXSB, FXSBSE and FXSE and the rider and passenger position on '18-later Softail models).

C. ENDGAME COLLECTION RIDER FOOTBOARDS – BLACK ANODIZED

With their slotted design, these Endgame Footboards add a custom industrial look to your ride. These footboards feature four raised rubber pads for superior grip and Harley-Davidson script for added style. Kit includes left and right footboards

50501679 **\$372.95**

Fits '18-later FL Softail models equipped with rider footboards.

50501680 **\$372.95**

Fits '09-later Touring models.



A. ENDGAME COLLECTION HAND GRIPS – BLACK ANODIZED



B. ENDGAME COLLECTION FOOTPEGS – BLACK ANODIZED



B. ENDGAME COLLECTION FOOTPEGS – BLACK ANODIZED



B. ENDGAME COLLECTION FOOTPEGS – BLACK ANODIZED



B. ENDGAME COLLECTION FOOTPEGS – BLACK ANODIZED



C. ENDGAME COLLECTION RIDER FOOTBOARDS – BLACK ANODIZED



C. ENDGAME COLLECTION RIDER FOOTBOARDS – BLACK ANODIZED



D. ENDGAME COLLECTION BRAKE PEDAL PAD – BLACK ANODIZED



D. ENDGAME COLLECTION BRAKE PEDAL PAD – BLACK ANODIZED



E. ENDGAME COLLECTION BRAKE LEVER – BLACK ANODIZED (SHOWN WITH ENDGAME COLLECTION BRAKE PEDAL PAD)



E. ENDGAME COLLECTION BRAKE LEVER – BLACK



F. ENDGAME COLLECTION SHIFTER PEG – BLACK



G. ENDGAME COLLECTION SHIFT LEVER – BLACK ANODIZED (SHOWN WITH ENDGAME COLLECTION SHIFTER PEG)

CONTROLS 479

Hand & Foot Controls Collection

D. ENDGAME COLLECTION BRAKE PEDAL PAD – BLACK ANODIZED

Showcasing a slotted design and black finish, these easy-to-install brake pedal pads complement the Endgame Collection controls to give your ride a custom industrial look.

50600401 **\$54.95**

Fits '18-later FL SL, FLDE, FLFB, FLFBS, FLHC, and FLHCS models equipped with Endgame Brake Lever P/N 41600299 or 41600298 and '14-later Touring models equipped with Endgame Brake Lever P/N 41600305 or P/N 41600304.

E. ENDGAME COLLECTION BRAKE LEVER – BLACK

Styled to complement the Endgame Collection controls, this Rear Brake Lever features a slotted design that will give your performance bike an industrial look.

41600299 **\$194.95**

Fits '18-later FL Softail® models equipped with Footboards.

41600305 **\$194.95**

Fits '14-later Touring and Trike models.

F. ENDGAME COLLECTION SHIFTER PEG – BLACK ANODIZED

With its slotted design, this easy-to-install shifter peg complements the high-tech, industrial look of the Endgame Collection footpegs and footboards.

33600303 **\$48.95**

Fits '86-later FL Softail®, '88-later Touring and '08-later Trike models equipped with Endgame Collection Shift Levers.

G. ENDGAME COLLECTION SHIFT LEVER – BLACK ANODIZED

Styled to complement the Endgame Collection controls, this Shift Lever features a slotted design that will give your bike a high-tech, industrial look.

33600301 **\$111.95**

Fits '86-later FL Softail, '88-later Touring and '08-later Trike models.

Model Family Fitment:

- V-ROD
- SPORTSTER
- DYNA
- SOFTAIL
- TOURING

Notice: The prices appearing in this catalog are the manufacturer's suggested retail prices. Actual retail prices may vary.

Notice: The prices appearing in this catalog are the manufacturer's suggested retail prices. Actual retail prices may vary.

CONTROLS

480 CONTROLS

Hand & Foot Controls Collection

DOMINION™ COLLECTION – BLACK

Express your bold, renegade attitude. The Dominion™ Collection Rider and Passenger Controls let you set your own styling direction. Crafted from aluminum, these hand and foot controls feature a rugged machined surface and the foot controls allow for interchangeable inserts in brushed black, bronze powder-coated, brushed aluminum or brushed orange anodized inserts (sold separately) that allow you to create your own unique look.

- A. DOMINION COLLECTION HAND GRIPS – BLACK**
56100232 **\$140.95**
 Fits '02-'17 VRSC™, '96-'22 XL, '08-'13 XR, '91-'17 Dyna® (except FXDLS), '96-'15 Softail® (except FLSTNSE, FXSBSE and '11-'12 FLSTSE) and '96-'07 Touring models.
- 56100231** **\$140.95**
 Fits '20-later LiveWire®, '16-'17 Dyna FXDLS and '16-later Softail models, '11-'12 FLSTSE, '14-'15 FLSTNSE, '13-'14 FXSBSE, '16-'17 FXSE and '08-later Touring (except '18-'19 FLTRXSE) and Trike models.

- B. DOMINION COLLECTION RIDER FOOTBOARD KIT – BLACK**
50500869 Rider. **\$449.95**
 Fits '18-later FL Softail models equipped with rider footboards.

- C. DOMINION COLLECTION BRAKE PEDAL PADS – BLACK**
50600267 Small. **\$62.95**
 Fits '18-later FL SB, FXBR and FXBRS models. Also fits '18-later Softail models equipped with Billet Style Rear Brake Lever for Forward Controls P/N 41600218, 41600219 and 41600220.

- 50600266** Large. **\$76.95**
 Fits '18-later FL Softail models equipped with rider footboards.

- 50600346** Large. **\$83.95**
 Fits '12-'16 FLD, '86-'17 FL Softail and '80-later Touring and Trike models.

- D. DOMINION COLLECTION FOOTPEGS – BLACK**
50500947 With Removable Wear Peg. **\$173.95**
 Fits models with H-D® male mount-style footpeg supports (except rider position on '17-later XG750A, '07-'10 XL883L, '07-'22 XL883N, XL1200N, XL1200V and XL1200X, '11-'22 XL1200C and XL1200T, '18-'22 XL1200NS and XL1200XS, '08-'13 XR and '08-'17 FXCW, FXCWC, FXS, FXSB, FXSE and FXSBSE models and the rider and passenger position on '18-later Softail models).

- 50500870** Rider. **\$173.95**
 Fits rider position on '20-later LiveWire, '18-later FXFB, FXFBS, and '19-later FXDRS models.

- 50500871** Rider. **\$178.95**
 Fits rider position on '18-later FL SB, FXBB, FXBBS, FXBR, FXBRS, FXLR, FXLRS and FXST models. Also fits '18 later FLDE, FLHC, FLHCS, FLSL, FLFB and FLFBS models equipped with Footboard To Footpeg Conversion Kit P/N 50501640 and '09-later Touring models equipped with Board-To-Peg Conversion Kit P/N 50501642.

- 50501558** Passenger. **\$173.95**
 Fits models in passenger and highway peg positions. Does not fit the rider and passenger position for '18-later Softail models.

- 50500992** Passenger. **\$173.95**
 Fits passenger position on '21-later Pan America®, '20-later LiveWire and '18-later Softail models.

- E. DOMINION COLLECTION SHIFTER PEG – BLACK**
33600180 **\$47.95**
 Fits all models (except '06-'17 VRSC™ models with forward controls and '08-'13 XR models).



A. DOMINION HAND GRIPS – BLACK



B. DOMINION RIDER FOOTBOARD – BLACK (SHOWN WITH LARGE BRAKE PEDAL PAD)



C. DOMINION BRAKE PEDAL PADS – BLACK



D. DOMINION FOOTPEGS – BLACK (50500870 SHOWN)



D. DOMINION FOOTPEGS – BLACK (50500871 SHOWN)



D. DOMINION FOOTPEGS – BLACK (50500992 SHOWN)



E. DOMINION SHIFTER PEG – BLACK



F. DOMINION HAND GRIPS – BRONZE



G. DOMINION RIDER FOOTBOARD – BRONZE (SHOWN WITH LARGE BRAKE PEDAL PAD)



H. DOMINION BRAKE PEDAL PADS – BRONZE



I. DOMINION FOOTPEGS – BRONZE (50500873 SHOWN)



I. DOMINION FOOTPEGS – BRONZE (50500874 SHOWN)



I. DOMINION FOOTPEGS – BRONZE (50500993 SHOWN)



J. DOMINION SHIFTER PEG – BRONZE

CONTROLS 481

Hand & Foot Controls Collection

DOMINION™ COLLECTION – BRONZE

Express your bold, renegade attitude. The Dominion™ Collection Rider and Passenger Controls let you set your own styling direction. Crafted from aluminum, these hand and foot controls feature a rugged machined surface and the foot controls allow for interchangeable inserts in brushed black, bronze powder-coated, brushed aluminum or brushed orange anodized inserts (sold separately) that allow you to create your own unique look.

- F. DOMINION COLLECTION HAND GRIPS – BRONZE**
56100235 **\$140.95**
 Fits '02-'17 VRSC™, '96-'22 XL, '08-'13 XR, '91-'17 Dyna® (except FXDLS), '96-'15 Softail® (except FLSTNSE, FXSBSE and '11-'12 FLSTSE) and '96-'07 Touring models.
- 56100234** **\$140.95**
 Fits '20-later LiveWire®, '16-'17 Dyna FXDLS and '16-later Softail models, '11-'12 FLSTSE, '14-'15 FLSTNSE, '13-'14 FXSBSE, '16-'17 FXSE and '08-later Touring (except '18-'19 FLTRXSE) and Trike models.

- G. DOMINION COLLECTION RIDER FOOTBOARD KIT – BRONZE**
50500872 Rider. **\$442.95**
 Fits '18-later FL Softail models equipped with rider footboards.

- 50501295A** Rider. **\$442.95**
 Fits '12-'16 FLD, '00-'17 FL Softail, '00-later Touring (except FLHTCUL and FLHTKL), and '09-later Trike models.

- H. DOMINION COLLECTION BRAKE PEDAL PADS – BRONZE**
50600269 Small. **\$68.95**
 Fits '18-later FL SB, FXBR and FXBRS models. Also fits '18-later Softail models equipped with Billet Style Rear Brake Lever for Forward Controls P/N 41600218, 41600219 and 41600220.

- 50600268** Large. **\$83.95**
 Fits '18-later FL Softail models equipped with rider footboards.

- 50600347** Large. **\$83.95**
 Fits '12-'16 FLD, '86-'17 FL Softail and '80-later Touring and Trike models.

- I. DOMINION COLLECTION FOOTPEGS – BRONZE**
50500949 With Removable Wear Peg. **\$178.95**
 Fits models with H-D® male mount-style footpeg supports (except rider position on '17-later XG750A, '07-'10 XL883L, '07-'22 XL883N, XL1200N, XL1200V and XL1200X, '11-'22 XL1200C and XL1200T, '18-'22 XL1200NS and XL1200XS, '08-'13 XR and '08-'17 FXCW, FXCWC, FXS, FXSB, FXSE and FXSBSE models and the rider and passenger position on '18-later Softail models).

- 50500873** Rider. **\$178.95**
 Fits rider position on '20-later LiveWire, '18-later FXFB, FXFBS, and '19-later FXDRS models.

- 50500874** Rider. **\$178.95**
 Fits rider position on '18-later FL SB, FXBB, FXBBS, FXBR, FXBRS, FXLR, FXLRS and FXST models. Also fits '18 later FLDE, FLHC, FLHCS, FLSL, FLFB and FLFBS models equipped with Footboard To Footpeg Conversion Kit P/N 50501640 and '09-later Touring models equipped with Board-To-Peg Conversion Kit P/N 50501642.

- 50501559** Passenger. **\$178.95**
 Fits models in passenger and highway peg positions. Does not fit the rider and passenger position for '18-later Softail models.

- 50500993** Passenger. **\$178.95**
 Fits passenger position on '21-later Pan America®, '20-later LiveWire and '18-later Softail models.

- J. DOMINION COLLECTION SHIFTER PEG – BRONZE**
33600214 **\$47.95**
 Fits all models (except '06-'17 VRSC™ models with forward controls and '08-'13 XR models).

Model Family Fitment:

- V-ROD
- SPORTSTER
- DYNA
- SOFTAIL
- TOURING

Notice: The prices appearing in this catalog are the manufacturer's suggested retail prices. Actual retail prices may vary.

Notice: The prices appearing in this catalog are the manufacturer's suggested retail prices. Actual retail prices may vary.

482 CONTROLS

Hand & Foot Controls Collection

DOMINION™ COLLECTION FOOT CONTROL INSERTS

Make your bike a true custom of one. The Dominion™ Inserts allow you to customize and personalize Dominion Collection accessories, so your bike is truly one of a kind.

A. DOMINION COLLECTION FOOTPEG TRIM PIECE

Fits Dominion Footpegs. Sold in sets of 2.

50500937	Brushed Black.	\$33.95
50500938	Bronze.	\$34.95
50500939	Brushed Orange.	\$33.95
50500940	Brushed Aluminum.	\$33.95

B. DOMINION COLLECTION SHIFTER PEG TRIM PIECE

Fits Dominion Shifter Pegs P/N 33600180 and 33600214.

33600215	Brushed Black.	\$18.95
33600216	Bronze.	\$18.95
33600217	Brushed Orange.	\$18.95
33600218	Brushed Aluminum.	\$18.95

C. DOMINION COLLECTION BRAKE PEDAL TRIM PIECE

Fits Dominion Large Brake Pedal Pads P/Ns 50600266 and 50600268.

50600290	Brushed Black.	\$33.95
50600291	Bronze.	\$33.95
50600292	Brushed Orange.	\$33.95
50600293	Brushed Aluminum.	\$33.95

Fits Dominion Large Brake Pedal Pads P/Ns 50600346 and 50600347.

50600365	Brushed Black.	\$33.95
50600366	Bronze.	\$33.95
50600368	Brushed Orange.	\$33.95
50600367	Brushed Aluminum.	\$33.95

Fits Dominion Small Brake Pedal Pads P/Ns 50600267 and 50600269.

50600294	Brushed Black.	\$28.95
50600295	Bronze.	\$28.95
50600296	Brushed Orange.	\$28.95
50600297	Brushed Aluminum.	\$28.95



A. DOMINION FOOTPEG TRIM (ORANGE SHOWN)



A. DOMINION FOOTPEG TRIM



B. DOMINION SHIFTER PEG TRIM (BRUSHED ALUMINUM SHOWN)



B. DOMINION SHIFTER PEG TRIM



C. DOMINION BRAKE PEDAL TRIM (BLACK SHOWN)



C. DOMINION BRAKE PEDAL TRIM



D. VOLTAIC HAND GRIPS



E. VOLTAIC RIDER FOOTPEGS



E. VOLTAIC PASSENGER FOOTPEGS



F. HARLEY-DAVIDSON® BY RIZOMA - HAND GRIPS



G. HARLEY-DAVIDSON® BY RIZOMA - FOOTPEGS

CONTROLS 483

Hand & Foot Controls Collection

D. VOLTAIC™ HAND GRIPS

These sleek, premium hand grips feature high-quality rubber and metal construction to provide excellent grip for comfortable, confident riding. Designed to complement the lines of your motorcycle, the Voltaic™ Grips enhance the overall style of your bike with a look that's light, fast and agile.

56100330		\$172.95
Fits '20-later LiveWire® (except Europe, India, China, and Vietnam markets), '16-'17 Dyna® FXDLS and '16-later Softail® models, '11-'12 FLSTSE, '14-'15 FLSTNSE, '13-'14 FXSBSE, '16-'17 FXSE and '08-later Touring (except '18-'19 FLTRXSE) and Trike models.		

E. VOLTAIC FOOTPEGS

Sleek and streamlined with an aggressive wedge shape, the Voltaic Footpegs are designed to complement the lines of your motorcycle. These gloss black and chrome accented Footpegs feature lightweight and durable aluminum construction while the solid rubber tread helps keep your feet firmly in place, so you're always ready to hit the throttle and work your way through tight urban riding environments.

50501197	Rider.	\$170.95
Fits rider position on '20-later LiveWire, '18-later FXFB, FXFBS, and '19-'20 FXDRS models.		

50501510	Passenger.	\$170.95
Fits passenger position on '20-later LiveWire and '18-later Softail models.		

HARLEY-DAVIDSON® BY RIZOMA

Precision craftsmanship and unmistakable style define this collaborative collection from Harley-Davidson and Rizoma. Lasered H-D and Rizoma logos on a subdued black on black finish display minimal branding that lets the machined texture and performance aesthetic take the lead. This sleek collection of billet aluminum accessories is the first co-branded collection of its kind designed exclusively for H-D® motorcycle riders.

F. HARLEY-DAVIDSON® BY RIZOMA – HAND GRIPS

Harley-Davidson by Rizoma handgrips are 1.44 inches in diameter and feature a textured rubber grip to inspire confidence in handling while riding.

56100479		\$215.95
Fits '20-later LiveWire®, '16-'17 Dyna® FXDLS and '16-later Softail® models, '11-'12 FLSTSE, '14-'15 FLSTNSE, '13-'14 FXSBSE, '16-'17 FXSE and '08-later Touring (except '18-later FLTRXSE) and Trike models.		

G. HARLEY-DAVIDSON® BY RIZOMA – FOOTPEGS

A bright, machined surface on Harley-Davidson by Rizoma footpegs offers the passenger a level of confidence in boot grip while adding a striking element of contrast to a dark-finished style.

50502158	Rider.	\$266.95
Fits rider position on '20-later LiveWire, '18-late FXFB, FXFBS, and '19-'20 FXDRS models.		

50502159	Passenger.	\$266.95
Fits passenger position on '20-later LiveWire and '18-later Softail models.		

Model Family Fitment:

■ V-ROD	■ SPORTSTER	■ DYNA
■ SOFTAIL	■ TOURING	

Notice: The prices appearing in this catalog are the manufacturer's suggested retail prices. Actual retail prices may vary.

Notice: The prices appearing in this catalog are the manufacturer's suggested retail prices. Actual retail prices may vary.

484 CONTROLS

Hand & Foot Controls Collection

A. WILLIE G SKULL HAND GRIPS – BLACK

Contrasting the sinister Willie G Skull logo surrounded by Harley-Davidson script, the raised rubber pads add positive grip and comfort for the long haul. Easy to install, these grips feature a glueless design that allows removal without damage.

56100364 **\$108.95**

Fits '02-'17 VRSC™, '96-'22 XL '08-'13 XR, '91-'17 Dyna® (except FXDLS), '96-'15 Softail® (except FLSTNSE, FXSBSE and '11-'12 FLSTSE) and '96-'07 Touring models.

56100361 **\$108.95**

Fits '20-later LiveWire®, '16-'17 Dyna FXDLS and '16-later Softail models, '11-'12 FLSTSE, '14-'15 FLSTNSE, '13-'14 FXSBSE, '16-'17 FXSE and '08-later Touring (except '18-'19 FLTRXSE) and Trike models.



A. WILLIE G SKULL HAND GRIPS – BLACK

B. WILLIE G SKULL BRAKE PEDAL PADS – BLACK

Available in two sizes to fit most Harley-Davidson® motorcycles, these easy-to-install brake pedal pads feature rich black rubber for grip and traction and they complement Willie G Skull Collection Footpegs and Footboard Inserts for a complete look.

50600342 Small. **\$64.95**

Fits '15-'20 XG models (except XG750A), '14-'22 XL models with Extended Reach Forward Control Kit P/N 50700030, '93-'17 Dyna models with forward controls, and '84-'17 FX Softail models (except FXSTDSE).

50600344 Small. **\$64.95**

Fits '18-later FXBR, FXBRS and FL5B models. Also fits '18-later Softail models equipped with Billet Style Rear Brake Lever for Forward Controls P/N 41600218, 41600219 and 41600220.

50600343 Large. **\$74.95**

Fits '12-'16 FLD, '86-'17 FL Softail and '80-later Touring and Trike models.

50600345 Large. **\$74.95**

Fits '18-later FL Softail models equipped with rider footboards.



A. WILLIE G SKULL BRAKE PEDAL PADS – BLACK

C. WILLIE G SKULL FOOTPEGS – BLACK

Styled to complement Willie G Skull Accessory items, these obsidian black Footpegs feature a raised Willie G Skull and Harley-Davidson Motorcycles script surrounded by rich black rubber for grip and traction. Footpeg rotation is adjustable for position, so your feet ride on the rubber treads whether used as a rider, passenger or highway peg. Kit includes left and right peg.

50501288 Black. **\$90.95**

Fits models with H-D® male mount-style footpeg supports (except the rider position on '15-later XG, '07-'10 XL883L, '07-'22 XL883N, XL1200N, XL1200T, XL1200V and XL1200X, '11-'22 XL1200C, '16-'22 XL1200CX, '17-'22 XL1200CP and XL1200CA, '08-'13 XR and '08-'17 FXCW, FXCWC, FXS, FXSB, FXSBSE and FXSE and the rider and passenger position on '18-later Softail models).

50501281 Rider Footpegs. **\$90.95**

Fits '18-later FL5B, FXBB, FXBBS, FXBR, FXBRS, FXLR, FXLRS and FXST models. Also fits '18 later FLDE, FLHC, FLHCS, FL5L, FLFB and FLFBS models equipped with Footboard To Footpeg Conversion Kit P/N 50501640 and '09-later Touring models equipped with Board-To-Peg Conversion Kit P/N 50501642.

50501282 Passenger Footpegs. **\$90.95**

Fits passenger position on '20-later LiveWire® and '18-later Softail models.



B. WILLIE G SKULL BRAKE PEDAL PADS – BLACK



C. WILLIE G SKULL FOOTPEGS – BLACK (50501288 SHOWN)



C. WILLIE G SKULL FOOTPEGS – BLACK (50501281 SHOWN)



C. WILLIE G SKULL FOOTPEGS – BLACK (50501282 SHOWN)



D. WILLIE G SKULL SHIFTER PEG – BLACK



E. WILLIE G SKULL RIDER FOOTBOARD INSERTS – BLACK, TRADITIONAL STYLE



E. WILLIE G SKULL RIDER FOOTBOARD INSERTS – BLACK, CONTEMPORARY STYLE



E. WILLIE G SKULL PASSENGER FOOTBOARD INSERTS – BLACK, CLASSIC STYLE



E. WILLIE G SKULL RIDER FOOTBOARD INSERTS – BLACK, SWEEP WING STYLE



E. WILLIE G SKULL RIDER FOOTBOARD INSERTS – BLACK, CLASSIC STYLE



E. WILLIE G SKULL PASSENGER FOOTBOARD INSERTS – BLACK, TRADITIONAL STYLE



E. WILLIE G SKULL PASSENGER FOOTBOARD INSERTS – BLACK, CONTEMPORARY STYLE

CONTROLS 485

Hand & Foot Controls Collection

D. WILLIE G SKULL SHIFTER PEG – BLACK

Styled to complement the Willie G Skull Collection Foot Controls, this easy-to-install shifter peg can be rotated to a comfortable position and the smooth back protects the toe of your boot from wear while shifting.

33600258 **\$33.95**

Fits all models (except '06-'17 VRSC™ models with forward controls and '08-'13 XR).

E. WILLIE G SKULL FOOTBOARD INSERTS – BLACK

Drenched in black and styled to match the Willie G Skull Collection Accessories, these footboard inserts retain the cast-in vibration isolation found on Original Equipment footboards. The over-molded rubber provides both comfort and traction while riding. Kit includes right and left insert.

50501286 Rider – Swept Wing Style. **\$107.95**

Fits '12-'16 FLD and '86-'17 Softail®, '86-later Touring and Trike models equipped with Swept Wing rider footboards.

50501287 Rider – Traditional Style. **\$107.95**

Fits models with traditional style rider footboards. Does not fit '18-later Softail models.

50501284 Rider – Classic Style. **\$107.95**

Fits '18-later FL Softail models equipped with classic style rider footboards.

50501283 Rider – Contemporary Style. **\$107.95**

Fits '18-later FL Softail models equipped with contemporary style rider footboards.

50501285 Passenger – Traditional Style. **\$95.95**

Fits models equipped with traditional-style passenger footboards. Does not fit '18-later Softail models.

50501289 Passenger – Classic Style. **\$95.95**

Fits models with classic-style passenger footboards.

50501290 Passenger – Contemporary Style. **\$95.95**

Fits models with contemporary-style passenger footboards.

Model Family Fitment:

- V-ROD
- SPORTSTER
- DYNA
- SOFTAIL
- TOURING

Notice: The prices appearing in this catalog are the manufacturer's suggested retail prices. Actual retail prices may vary.

Notice: The prices appearing in this catalog are the manufacturer's suggested retail prices. Actual retail prices may vary.

486 CONTROLS

Hand & Foot Controls Collection

WILLIE G SKULL COLLECTION – CHROME

The deep black rubber pads are set against a brilliant polished and chrome-plated field to yield the dramatic appearance of the Skull Collection.

A. WILLIE G SKULL HAND GRIPS – CHROME

Contrasting the chrome sinister skull logo surrounded by Harley-Davidson script, the raised rubber pads add positive grip and comfort for the long haul. Easy to install, these grips feature a glueless design that allows removal without damage.

Fits '02-'17 VRSC™, '96-'22 XL '08-'13 XR, '91-'17 Dyna® (except FXDLS), '96-'15 Softail® (except FLSTNSE, FXSBSE and '11-'12 FLSTSE) and '96-'07 Touring models.

56751-04 Small 1.3" Diameter. **\$108.95**

56740-04 Medium 1.5" Diameter. **\$108.95**

56741-04 Large 1.6" Diameter. **\$108.95**

Fits '20-later LiveWire®, '16-'17 Dyna FXDLS and '16-later Softail models, '11-'12 FLSTSE, '14-'15 FLSTNSE, '13-'14 FXSBSE, '16-'17 FXSE and '08-later Touring (except '18-'19 FLTRXSE) and Trike models.

56740-08 Medium 1.5" Diameter. **\$108.95**

B. WILLIE G SKULL BRAKE PEDAL PADS – CHROME

Available in two sizes to fit most Harley-Davidson® motorcycles, these easy-to-install brake pedal pads complement Willie G Collection pegs and footboard inserts for a complete look.

42710-04 Small. **\$64.95**

Fits '15-'20 XG models (except XG750A), '14-'22 XL models with Extended Reach Forward Control Kit P/N 50700030, '93-'17 Dyna models with forward controls, and '84-'17 FX Softail models (except FXSTDSE).

50600313 Small. **\$64.95**

Fits '18-later FXBR, FXBRS and FLSB models. Also fits '18-later Softail models equipped with Billet Style Rear Brake Lever for Forward Controls P/N 41600218, 41600219 and 41600220.

42711-04 Large. **\$74.95**

Fits '12-'16 FLD, '86-'17 FL Softail and '80-later Touring and Trike models.

50600311 Large. **\$74.95**

Fits '18-later FL Softail models equipped with rider footboards.

C. WILLIE G SKULL FOOTPEGS – CHROME

Footpeg rotation is adjustable for position, so your feet ride on the rubber treads whether used as a rider, passenger or high-way peg. Kit includes left and right peg.

50370-04 **\$90.95**

Fits models with H-D® male mount-style footpeg supports (except the rider position on '15-later XG, '07-'10 XL883L, '07-'22 XL883N, XL1200N, XL1200T, XL1200V and XL1200X, '11-'22 XL1200C, '16-'22 XL1200CX, '17-'22 XL1200CP and XL1200CA, '18-'22 XL1200NS and XL1200XS, '08-'13 XR and '08-'17 FXCW, FXCWC, FXS, FXSB, FXSBSE and FXSE and the rider and passenger position on '18-later Softail models).

50500856 Rider Footpegs. **\$90.95**

Fits '18-later FLSB, FXBB, FXBBS, FXBR, FXBRS, FXLR, FXLRS and FXST models. Also fits '18 later FLDE, FLHC, FLHCS, FLSL, FLFB and FLFB models equipped with Board-To-Peg Conversion Kit P/N 50501640 and '09-later Touring models equipped with Board-To-Peg Conversion Kit P/N 50501642.

50500858 Passenger Footpegs. **\$90.95**

Fits passenger position on '20-later LiveWire® and '18-later Softail models.



A. WILLIE G SKULL HAND GRIPS – CHROME



A. WILLIE G SKULL HAND GRIPS – CHROME



WILLIE G SKULL COLLECTION FOOT CONTROLS – CHROME



B. WILLIE G SKULL BRAKE PEDAL PADS – CHROME



C. WILLIE G SKULL FOOTPEGS – CHROME (50370-04 SHOWN)



C. WILLIE G SKULL RIDER FOOTPEGS – CHROME (50500856 SHOWN)



C. WILLIE G SKULL PASSENGER FOOTPEGS – CHROME (50500858 SHOWN)



D. WILLIE G SKULL SHIFTER PEG – CHROME



E. WILLIE G SKULL RIDER FOOTBOARD INSERTS, CHROME – TRADITIONAL STYLE



E. WILLIE G SKULL RIDER FOOTBOARD INSERTS, CHROME – SWEEP WING STYLE



E. WILLIE G SKULL RIDER FOOTBOARD INSERTS, CHROME – CONTEMPORARY STYLE



E. WILLIE G SKULL PASSENGER FOOTBOARD INSERTS, CHROME – TRADITIONAL STYLE



E. WILLIE G SKULL PASSENGER FOOTBOARD INSERTS, CHROME – CLASSIC STYLE



E. WILLIE G SKULL PASSENGER FOOTBOARD INSERTS, CHROME – CONTEMPORARY STYLE

CONTROLS 487

Hand & Foot Controls Collection

D. WILLIE G SKULL SHIFTER PEG – CHROME

This easy-to-install shifter peg can be rotated to a comfortable position and the smooth back protects the toe of your boot from wear while shifting.

34689-04 Fits all models (except '06-'17 VRSC™ models with forward controls and '08-'13 XR). **\$33.95**

E. WILLIE G SKULL FOOTBOARD INSERTS – CHROME

Easy-to-install footboard kits retain the Original Equipment cast-in vibration isolation for a fatigue-free ride. Kit includes left and right insert.

50704-04 Rider – Swept Wing Style. **\$107.95**

Fits '12-'16 FLD and '86-'17 Softail®, '86-later Touring and Trike models equipped with Swept Wing-style rider footboards.

50710-04 Rider – Traditional Style. **\$107.95**

Fits models with traditional-style rider footboards. Does not fit '18-later Softail models.

50500722 Rider – Classic Style. **\$107.95**

Fits '18-later FL Softail models equipped with classic style rider footboards.

50500718 Rider – Contemporary Style. **\$112.95**

Fits models with traditional-style rider footboards.

50713-04 Passenger – Traditional Style. **\$95.95**

Fits models equipped with traditional-style passenger footboards.

50501142 Passenger – Classic Style. **\$95.95**

Fits models with classic-style passenger footboards.

50501145 Passenger – Contemporary Style. **\$95.95**

Fits models with contemporary-style passenger footboards.

Model Family Fitment:

V-ROD
 SPORTSTER
 DYNA
 SOFTAIL
 TOURING

Notice: The prices appearing in this catalog are the manufacturer's suggested retail prices. Actual retail prices may vary.

Notice: The prices appearing in this catalog are the manufacturer's suggested retail prices. Actual retail prices may vary.

CONTROLS

488 CONTROLS

Hand & Foot Controls Collection

KAHUNA™ COLLECTION HAND AND FOOT CONTROLS – GLOSS BLACK

Understated but powerful, the Kahuna™ Collection Controls feature a gloss black surfaces surrounded by rich, black rubber that provides grip and traction where needed. These gloss black controls are styled to complement other Kahuna Collection Accessories and the Hand Grips and Rider Footboards also feature a rich red Bar & Shield logo.

A. KAHUNA HAND GRIPS – GLOSS BLACK

56100332 **\$151.95**
Fits '20-later LiveWire®, '16-'17 Dyna® FXDLS and '16-later Softail® models, '11-'12 FLSTSE, '14-'15 FLSTNSE, '13-'14 FXSBSE, '16-'17 FXSE and '08-later Touring (except '18-'19 FLTRXSE) and Trike models.



A. KAHUNA HAND GRIPS – GLOSS BLACK

B. KAHUNA FOOTPEGS – GLOSS BLACK

50501225 **\$149.95**
Fits rider position: '02-'17 VRSC™ models with forward controls (except VRSCDX and VRSCF), '15-'20 XG models (except XG750A), '06-earlier XL, '07-'10 XL883, XL883C, XL883R, XL1200C and XL1200R, '07-'11 XL1200L, '91-'17 Dyna® (except FLD), and '84-'17 Softail models with forward controls (except FXCW, FXCWC, FXS, FXSB or FXBSE). Fits passenger position: all models with H-D® male-mount passenger peg mounts (except '06-earlier VRSC, '03-earlier XL, '05-earlier Dyna and Softail models equipped with Shotgun exhaust). '84-'17 Softail models require separate purchase of Support Kit P/N 50454-09. Does not fit passenger position on '18-later Softail models. Fits highway peg position: all models with frame-mount or engine guard-mount highway pegs (except Whiskers Adjustable Highway Bar P/N 50855-09 and 50865-09).



B. KAHUNA FOOTPEGS – GLOSS BLACK

C. KAHUNA SHIFTER PEG – GLOSS BLACK

33600257 **\$47.95**
Fits all models (except '06-'17 VRSC models with forward controls and '08-'13 XR models).



C. KAHUNA SHIFTER PEG – GLOSS BLACK

D. KAHUNA BRAKE PEDAL PAD – GLOSS BLACK

50600341 Large. **\$86.95**
Fits '12-'16 FLD, '86-'17 FL Softail and '80-later Touring and Trike models.



B./C. KAHUNA FOOTPEG AND SHIFTER PEG – GLOSS BLACK

E. KAHUNA FOOTBOARD KITS – GLOSS BLACK

50501227 Rider. **\$393.95**
Fits '12-'16 FLD, '86-'17 FL Softail (except FLS, FLSS, FLSTFB, FLSTFBS and FXSE), '86-later Touring (except FLHTCUL and FLHTKL) and '08-later Trike models.

50501228 Passenger. **\$383.95**
Fits '06-'17 Dyna, '00-later Softail (except FXDRS, FXFB and FXFBS) and '86-later Touring models equipped with passenger footboard supports. Does not fit Trike models.



D. KAHUNA BRAKE PEDAL PAD – GLOSS BLACK



D. KAHUNA RIDER FOOTBOARDS KIT – GLOSS BLACK



E. KAHUNA PASSENGER FOOTBOARD KIT – GLOSS BLACK

CONTROLS 489

Hand & Foot Controls Collection

KAHUNA™ COLLECTION HAND AND FOOT CONTROLS – CHROME

Understated but powerful, the Kahuna™ Collection Controls feature a mirror-like chrome surface surrounded by rich, black rubber that provides grip and traction where needed. These chrome controls are styled to complement other Kahuna Collection Accessories and the Hand Grips and Rider Footboards also feature a rich red Bar & Shield logo.

F. KAHUNA HAND GRIPS – CHROME

56100319 **\$151.95**
Fits '20-later LiveWire®, '16-'17 Dyna® FXDLS and '16-later Softail® models, '11-'12 FLSTSE, '14-'15 FLSTNSE, '13-'14 FXSBSE, '16-'17 FXSE and '08-later Touring (except '18-'19 FLTRXSE) and Trike models.



F. KAHUNA HAND GRIPS – CHROME

G. KAHUNA FOOTPEGS – CHROME

50501148 **\$149.95**
Fits rider position: '02-'17 VRSC™ models with forward controls (except VRSCDX and VRSCF), '15-'20 XG models (except XG750A), '06-earlier XL, '07-'10 XL883, XL883C, XL883R, XL1200C and XL1200R, '07-'11 XL1200L, '91-'17 Dyna® (except FLD), and '84-'17 Softail models with forward controls (except FXCW, FXCWC, FXS, FXSB or FXBSE). Fits passenger position: all models with H-D® male-mount passenger peg mounts (except '06-earlier VRSC, '03-earlier XL, '05-earlier Dyna and Softail models equipped with Shotgun exhaust). '84-'17 Softail models require separate purchase of Support Kit P/N 50454-09. Does not fit passenger position on '18-later Softail models. Fits highway peg position: all models with frame-mount or engine guard-mount highway pegs (except Whiskers Adjustable Highway Bar P/N 50855-09 and 50865-09).



G. KAHUNA FOOTPEGS – CHROME



G./H. KAHUNA FOOTPEG AND SHIFTER PEG – CHROME

H. KAHUNA SHIFTER PEG – CHROME

33600256 **\$47.95**
Fits all models (except '06-'17 VRSC models with forward controls and '08-'13 XR models).



H. KAHUNA SHIFTER PEG – CHROME

I. KAHUNA BRAKE PEDAL PAD – CHROME

50600340 Large. **\$86.95**
Fits '12-'16 FLD, '86-'17 FL Softail and '80-later Touring and Trike models.



I. KAHUNA BRAKE PEDAL PAD – CHROME

J. KAHUNA FOOTBOARD KITS – CHROME

50501150 Rider. **\$399.95**
Fits '12-'16 FLD, '86-'17 FL Softail (except FLS, FLSS, FLSTFB, FLSTFBS and FXSE), '86-later Touring (except FLHTCUL and FLHTKL) and '08-later Trike models.

50501151 Passenger. **\$383.95**
Fits '06-'17 Dyna, '00-later Softail (except FXDRS, FXFB and FXFBS) and '86-later Touring models equipped with passenger footboard supports. Does not fit Trike models.



J. KAHUNA RIDER FOOTBOARDS KIT – CHROME



J. KAHUNA PASSENGER FOOTBOARD KIT – CHROME

Model Family Fitment:

- V-ROD
- SPORTSTER
- DYNA
- SOFTAIL
- TOURING

Notice: The prices appearing in this catalog are the manufacturer's suggested retail prices. Actual retail prices may vary.

Notice: The prices appearing in this catalog are the manufacturer's suggested retail prices. Actual retail prices may vary.

CONTROLS

490 CONTROLS

Hand & Foot Controls Collection

AIRFLOW COLLECTION – GLOSS BLACK

Defined by a sleek surround, the deep hockey-stick groove and the smooth rubber traction strips, this delta wing-inspired collection is the perfect match for your high-profile street machine. The rich black high-grip surfaces are divided by a deep channel that draws your eye from the leading to the trailing edge.

A. AIRFLOW HAND GRIPS – GLOSS BLACK

Wrap your fingers around the gloss black ridge for a sweet tactile feel. These grips combine a traction-grip crosshatch rubber surface with a comfortable 1.6" diameter for excellent control in wet or dry weather. The easy-to-install glueless design allows you to remove the grips for service without damage.

56100218 **\$108.95**

Fits '20-later LiveWire®, '16-'17 Dyna® FXDLS and '16-later Softail® models, '11-'12 FLSTSE, '14-'15 FLSTNSE, '13-'14 FXSBSE, '16-'17 FXSE and '08-later Touring (except '18-'19 FLTRXSE) and Trike models.

56100356 **\$108.95**

Fits '02-'17 VRSC™, '96-'22 XL, '08-'13 XR, '96-'17 Dyna (except FXDLS), '95-'15 Softail (except FLSTNSE, FLSTSE and FXSBSE and '11-'12 FLSTSE) '96-'07 Touring models.

B. AIRFLOW FOOTPEGS – GLOSS BLACK

These footpegs are adjustable for position and feature a rectangular shape and a raised rubber surface for foot support and traction whether used as a rider, passenger or highway peg.

50500717 **\$107.95**

Fits models with H-D® male mount-style footpeg supports (except the rider position on '17-later XG750A, '07-'10 XL883L, '07-'22 XL883N, XL1200N, XL1200V and XL1200X, '11-'22 XL1200C and XL1200T, '18-'22 XL1200NS and XL1200XS, '08-'13 XR, and '08-'17 FXCW, FXCWC, FXS, FXSB, FXSBSE and FXSE and the rider and passenger position on '18-later Softail models).

C. AIRFLOW SHIFTER PEG – GLOSS BLACK

This simple-to-install Shifter Peg complements the sweeping design of the Airflow Collection footpegs and footboards. Rotation is adjustable for comfortable shifting, and the rubber back protects the top of your boot while downshifting.

33600154 **\$33.95**

Fits all models (except '06-'17 VRSC models with forward controls, '17-'20 XG750A and '08-'13 XR).

D. AIRFLOW BRAKE PEDAL PAD – GLOSS BLACK

The Airflow Brake Pedal Pad features curving gloss black surrounding a deep black rubber pad, accented with a deep center groove. Easy to install, this brake pedal pad complements the Airflow Collection for a complete custom look.

50600232 Small. **\$48.95**

Fits '15-'20 XG models (except XG750A), '14-'22 XL models with Extended Reach Forward Control Kit P/N 50700030, '93-'17 Dyna models with forward controls, and '84-'17 FX Softail models (except FXSTDSE).

50600338 Large. **\$64.95**

Fits '12-'16 FLD, '86-'17 FL Softail and '80-later Touring and Trike models.

E. AIRFLOW FOOTBOARD KITS – GLOSS BLACK

Comfortable and stylish, these fighter-wing shaped footboards add an elegant finish to your ride. The complete kit includes gloss black delta wing-shaped footboard pans with vibration-isolated inserts for a fatigue-free ride. The black rubber pads feature a deep embossed Bar & Shield logo and rear-sweeping traction grooves.

50501265 Rider. **\$319.95**

Fits '12-'16 FLD, '86-'17 FL Softail (except FLS, FLSS, FLSTFB, FLSTFBS and FXSE), '86-later Touring (except FLHTCUL and FLHTKL) and '08-later Trike models.

50501266 Passenger. **\$235.95**

Fits '06-'17 Dyna, '18-later Softail (except FXDRS, FXFB and FXFBS) and '86-later Touring models equipped with passenger footboard supports. Does not fit Trike models.



A. AIRFLOW HAND GRIPS – GLOSS BLACK



B. AIRFLOW FOOTPEGS – GLOSS BLACK (SHOWN WITH SMALL AIRFLOW BRAKE PEDAL PAD)



B./C. AIRFLOW FOOTPEG & SHIFTER PEG – GLOSS BLACK



C. AIRFLOW SHIFTER PEG – GLOSS BLACK



D. AIRFLOW BRAKE PEDAL PAD – GLOSS BLACK



E. AIRFLOW RIDER FOOTBOARD KIT – GLOSS BLACK (SHOWN WITH LARGE AIRFLOW BRAKE PEDAL PAD)



E. AIRFLOW PASSENGER FOOTBOARD KIT – GLOSS BLACK



F. AIRFLOW HAND GRIPS – CHROME



G. AIRFLOW FOOTPEGS – CHROME (SHOWN WITH SMALL AIRFLOW BRAKE PEDAL PAD)



G./H. AIRFLOW FOOTPEG & SHIFTER PEG – CHROME



H. AIRFLOW SHIFTER PEG – CHROME



I. AIRFLOW BRAKE PEDAL PAD – CHROME



J. AIRFLOW RIDER FOOTBOARD KIT – CHROME (SHOWN WITH LARGE AIRFLOW BRAKE PEDAL PAD)



J. AIRFLOW PASSENGER FOOTBOARD KIT – CHROME

CONTROLS 491

Hand & Foot Controls Collection

AIRFLOW COLLECTION – CHROME

Defined by a brilliant chrome border and smooth rubber traction strips, this delta wing-inspired collection is the perfect match for your high-profile street machine. The rich black surfaces are divided by a deep mirror-finished groove that draws your eye from the leading to the trailing edge.

F. AIRFLOW HAND GRIPS – CHROME

Wrap your fingers around the chrome ridge for a sweet tactile feel. These grips combine a traction-grip crosshatch rubber surface with a comfortable 1.6" diameter for excellent control in wet or dry weather. The easy-to-install glueless design allows you to remove the grips for service without damage.

56100112 **\$108.95**

Fits '02-'17 VRSC™, '96-'22 XL, '08-'13 XR, '96-'17 Dyna® (except FXDLS), '95-'15 Softail® (except FLSTNSE, FLSTSE and FXSBSE and '11-'12 FLSTSE) '96-'07 Touring models.

56100108 **\$108.95**

Fits '20-later LiveWire®, '16-'17 Dyna FXDLS and '16-later Softail models, '11-'12 FLSTSE, '14-'15 FLSTNSE, '13-'14 FXSBSE, '16-'17 FXSE and '08-later Touring (except '18-'19 FLTRXSE) and Trike models.

G. AIRFLOW FOOTPEGS – CHROME

These footpegs are adjustable for position and feature a rectangular shape and a raised rubber surface for foot support and traction whether used as a rider, passenger or highway peg.

50500435 **\$107.95**

Fits models with H-D® male mount-style footpeg supports (except the rider position on '17-later XG750A, '07-'10 XL883L, '07-'22 XL883N, XL1200N, XL1200T, XL1200V and XL1200X, '11-'22 XL1200C, '16-'22 XL1200CX, '18-'22 XL1200NS and XL1200XS, '08-'13 XR and '08-'17 FXCW, FXCWC, FXS, FXSB, FXSBSE, FXSE and the rider and passenger position on '18-later Softail models).

H. AIRFLOW SHIFTER PEG – CHROME

This simple-to-install Shifter Peg complements the sweeping design of the Airflow Collection footpegs and footboards. Rotation is adjustable for comfortable shifting, and the rubber back protects the top of your boot while downshifting.

33600075 **\$33.95**

Fits all models (except '06-'17 VRSC™ models with forward controls, '17-'20 XG750A and '08-'13 XR models).

I. AIRFLOW BRAKE PEDAL PAD – CHROME

The Airflow Brake Pedal Pad features curving chrome surrounding a deep black rubber pad, accented with a deep center groove. Easy to install, this brake pedal pad complements the Airflow Collection for a complete custom look.

50600165 Small. **\$48.95**

Fits '15-'20 XG models (except XG750A), '14-'22 XL models with Extended Reach Forward Control Kit P/N 50700030, '93-'17 Dyna models with forward controls, and '84-'17 FX Softail models (except FXSTDSE).

50600159 Large. **\$64.95**

Fits '12-'16 FLD, '86-'17 FL Softail, '80-later Touring and Trike models.

J. AIRFLOW FOOTBOARD KITS – CHROME

Comfortable and stylish, these fighter-wing shaped footboards add an elegant finish to your ride. The complete kit includes chrome delta wing-shaped footboard pans with vibration-isolated inserts for a fatigue-free ride. The black rubber pads feature a deep embossed Bar & Shield logo and rear-sweeping traction grooves.

50500436 Rider. **\$327.95**

Fits '12-'16 FLD, '86-'17 FL Softail (except FLS, FLSS, FLSTFB, FLSTFBS and FXSE), '86-later Touring (except FLHTCUL and FLHTKL) and '08-later Trike models.

50500437 Passenger. **\$242.95**

Fits '06-'17 Dyna, '18-later Softail (except FXDRS, FXFB and FXFBS) and '86-later Touring models equipped with passenger footboard supports. Does not fit Trike models.

Model Family Fitment:

V-ROD
 SPORTSTER
 DYNA
 SOFTAIL
 TOURING

Notice: The prices appearing in this catalog are the manufacturer's suggested retail prices. Actual retail prices may vary.

Notice: The prices appearing in this catalog are the manufacturer's suggested retail prices. Actual retail prices may vary.

492 CONTROLS

Hand & Foot Controls Collection

STREAMLINER COLLECTION – CHROME

Inspired by the art-deco designs of the Streamliner era, this collection reflects the simple lines and shapes that still remain contemporary today. The rich black rubber features three raised chrome tri-line bands for contrast and a rich chrome surround to finish the look.

A. STREAMLINER HAND GRIPS – CHROME

Complement the Streamliner look with these matching grips. The rich black rubber provides a positive grip while riding and the chrome tri-line design will provide just the right touch of chrome.

56100048 **\$108.95**
Fits '20-later LiveWire®, '16-'17 Dyna® FXDLS and '16-later Softail® models, '11-'12 FLSTSE, '14-'15 FLSTNSE, '13-'14 FXSBSE, '16-'17 FXSE and '08-later Touring (except '18-'19 FLTRXSE) and Trike models.

B. STREAMLINER RIDER FOOTPEGS – CHROME

Complete the streamlined look with Streamliner Footpegs. Kit includes left and right footpegs.

50211-04 **\$170.95**
Fits rider positions on '03-earlier XL models with mid controls and '05-earlier Dyna models with mid controls. Fits all models in passenger and highway peg positions.

Shown with:

STREAMLINER SHIFTER PEG

Complement the streamlined footpegs and footboards with this simple-to-install Shifter Peg.

34967-04 **\$33.95**
Fits all models (except '06-'17 VRSC™ models with forward controls and '08-'13 XR models).

C. STREAMLINER BRAKE PEDAL PAD

Complement the streamlined footpegs and footboards with this simple-to-install Brake Pedal Pad. The chrome frame surrounds a black rubber pad accented with three polished bands for style and grip.

42712-04 Large **\$64.95**
Fits '12-'16 FLD, '86-'17 FL Softail and '80-later Touring and Trike models.

D. STREAMLINER RIDER FOOTBOARD KIT

Add the sleek sweeping footboard design from the Street Glide® model to your Touring bike. Kit includes vibration-isolation footboard pads with three polished bands, and the complete chrome-plated pans that easily bolt in place of the Original Equipment footboards.

50631-04 **\$265.95**
Fits '12-'16 FLD and '86-'17 FL Softail (except FLS, FLSS, FLSTFB and FLSTFBS), Touring and Trike models (except FLHTCUL and FLHTKL).

E. STREAMLINER PASSENGER FOOTBOARD INSERT KIT – SWEEP WING SHAPE

Styled to match the Street Glide model's Original Equipment Streamliner Rider Footboards. Featuring vibration-isolation rubber inserts with three polished bands, this insert is designed to fit the Swept Wing shape passenger footboard pan. Kit includes left and right side insert.

50420-05 **\$95.95**
Fits '06-'17 Dyna, '00-later Softail (except FXDRS, FXFB and FXFBS) and '86-later Touring models equipped with Swept Wing-shaped passenger footboards. Does not fit Trike models. If installed on models equipped with Passenger Footboard Support kit P/N 50399-07A, footboards will not remain in flipped up position.



A. STREAMLINER HAND GRIPS



B. STREAMLINER FOOTPEGS AND SHIFTER PEG



C. STREAMLINER BRAKE PEDAL PAD



D. STREAMLINER RIDER FOOTBOARD KIT (SHOWN WITH BRAKE PEDAL PAD AND FOOTPEG KIT)



E. STREAMLINER PASSENGER FOOTBOARD INSERTS – SWEEP WING SHAPE



F. STREAMLINER HAND GRIPS – BLACK



G. STREAMLINER RIDER FOOTPEGS – BLACK



H. STREAMLINER SHIFTER PEG – BLACK



I. STREAMLINER BRAKE PEDAL PAD – BLACK



J. STREAMLINER RIDER FOOTBOARDS – BLACK



K. STREAMLINER PASSENGER FOOTBOARDS AND MOUNT KIT – BLACK



L. STREAMLINER PASSENGER FOOTBOARD INSERT KIT – BLACK

CONTROLS 493

Hand & Foot Controls Collection

STREAMLINER COLLECTION - BLACK

Inspired by the curved forms and long, horizontal lines of Streamline Moderne architecture, the Black Streamliner Collection takes a contemporary spin on this classic Harley-Davidson style. Featuring polished chrome bands surrounded by a sea of rich black, the Black Streamliner Collection adds a dark and aerodynamic look to your bike.

F. STREAMLINER HAND GRIPS – BLACK

Complement the Streamliner look with these matching grips. The rich black rubber provides a positive grip when riding and the chrome tri-lines add just the right touch of brightness.

56100411 **\$108.95**
Fits '20-later LiveWire®, '16-'17 Dyna® FXDLS and '16-later Softail® models, '14-'15 FLSTNSE, '11-'12 FLSTSE, '13-'14 FXSBSE and '08-later Touring (except '18-later FLTRXSE) and Trike models.

G. STREAMLINER RIDER FOOTPEGS – BLACK

Complete the streamlined look with Streamliner Footpegs. Includes left and right footpegs.

50501800 **\$170.95**
Fits rider positions on '03-earlier XL models with mid controls and '05-earlier Dyna models with mid-controls. Fits all models in passenger and highway peg position.

H. STREAMLINER SHIFTER PEG – BLACK

Complement the black Streamliner Footpegs and Footboards with this simple-to-install Shifter Peg.

33600313 **\$33.95**
Fits all models (except '06-'17 VRSC™ models with forward controls and Matte Black '08-'13 XR models).

I. STREAMLINER BRAKE PEDAL PAD – BLACK

Complement the Streamliner footpegs and footboards with this simple-to-install Brake Pedal Pad. The gloss black frame surrounds a black rubber pad accented with three polished chrome bands for style and grip.

50600417 **\$64.95**
Fits '12-'16 FLD, '86-'17 FL Softail and '80-later Touring and Trike models.

J. STREAMLINER™ RIDER FOOTBOARDS – BLACK

Inspired by the sleek and sweeping footboard design from the Street Glide® model, these Rider Footboards add a clean yet striking look to your bike. Kit includes vibration-isolation footboard pads with three polished chrome bands, and the complete gloss black pans that easily bolt in place of the Original Equipment footboards.

50501801 **\$245.95**
Fits '12-'16 FLD and '86-'17 FL Softail® (except FLS, FLSS, FLSTFB and FLSTFBS), '86-later Touring (except FLHTCUL and FLHTKL) and Trike models.

K. STREAMLINER PASSENGER FOOTBOARD AND MOUNT KIT – BLACK

Designed for convenient bolt-on installation, the complete kit includes gloss black aluminum footboards, rubber pads, mounting hardware and passenger footboard supports.

50501819 **\$432.95**
Fits '93-later Touring models. Does not fit Trike models.

L. STREAMLINER COLLECTION PASSENGER FOOTBOARD INSERT KIT – BLACK

Featuring vibration-isolation rubber inserts with three polished chrome bands, this insert is designed to fit the Swept Wing shaper passenger footboard pan. Kit includes left and right insert.

50501796 **\$95.95**
Fits '06-'17 Dyna, '00-later Softail (except FXFB, FXFBS and FXDRS) and '86-later Touring models equipped with Swept Wing-shaped passenger footboards. Does not fit Trike models. If installed on models equipped with Passenger Footboard Support kit P/N 50399-07A, footboards will not remain in flipped up position.

Model Family Fitment:

- V-ROD
- SPORTSTER
- DYNA
- SOFTAIL
- TOURING

Notice: The prices appearing in this catalog are the manufacturer's suggested retail prices. Actual retail prices may vary.

Notice: The prices appearing in this catalog are the manufacturer's suggested retail prices. Actual retail prices may vary.

494 CONTROLS

Hand & Foot Controls Collection

EDGE CUT COLLECTION

Live your life on the edge. The Edge Cut Collection features a crisp anodized finish that is machined to expose the highlights of raw aluminum. The contrasting cut back look makes a powerful visual statement and works great with both traditional and contemporary customizing styles.

A. EDGE CUT HAND GRIPS

The hand grips are a comfortable 1.5" diameter and the machined slots and narrow rubber bands offer plenty of traction, with or without gloves. Glueless design permits removal for servicing without damage.

57454-10 \$108.95

Fits '02-'17 VRSC™, '96-'22 XL, '08-'13 XR, '91-'17 Dyna® (except FXDLS), '96-'15 Softail® (except FLSTNSE, FXSBSE and '11-'12 FLSTSE) and '96-'07 Touring models.

57457-10 \$108.95

Fits '20-later LiveWire®, '16-'17 Dyna FXDLS and '16-later Softail models, '11-'12 FLSTSE, '14-'15 FLSTNSE, '13-'14 FXSBSE, '16-'17 FXSE and '08-later Touring (except '18-'19 FLTRXSE) and Trike models.

B. EDGE CUT BRAKE PEDAL PADS

Available in two sizes, the brake pedal pads feature deep surface grooves and narrow rubber bands for traction during application.

50600317 Small. \$48.95

Fits '18-later FXBR, FXBRS and FLSB models. Also fits '18-later Softail models equipped with Billet Style Rear Brake Lever for Forward Controls P/N 41600218, 41600219 and 41600220.

50600318 Large. \$60.95

Fits '18-later FL Softail models equipped with rider footboards.

C. EDGE CUT FOOTPEGS AND SHIFTER PEG

The slim footpeg design allows a comfortable pivot point and the wide surface and narrow rubber bands hold your boots firmly in place.

1. 49312-10 Footpegs. \$90.95

Fits models with H-D® male mount-style footpeg supports (except the rider position on '17-later XG750A, '07-'10 XL883L, '07-'22 XL883N, XL1200N, XL1200T, XL1200V and XL1200X, '11-'22 XL1200C, '16-'22 XL1200CX, '18-'22 XL1200NS and XL1200XS, '08-'13 XR and '08-'17 FXCW, FXCWC, FXS, FXSB, FXSBSE, FXSE and the rider and passenger position on '18-later Softail models).

2. 50500967 Rider Footpegs with Removable Wear Peg. \$107.95

Fits rider position on '18-'20 FXBR and FXBRS models. Also fits '18 later FLDE, FLHC, FLHCS, FLSL, FLFB and FLFBS models equipped with Footboard To Footpeg Conversion Kit P/N 50501640 and '09-later Touring models equipped with Board-To-Peg Conversion Kit P/N 50501642.

3. 34671-10 Shifter Peg. \$33.95

Fits all models (except '06-'17 VRSC models with forward controls and '08-'13 XR).

D. EDGE CUT FOOTBOARD INSERT KITS

Machined from billet aluminum, these footboard inserts retain the cast-in vibration isolation found on Original Equipment footboards. The over-molded rubber provides both comfort and traction while riding. Kit includes right and left insert.

54187-10 Rider – Traditional Style. \$222.95

Fits models with traditional-style rider footboards. Does not fit '18-later Softail® models.

50501143 Passenger – Classic Style. \$191.95

Fits models with classic-style passenger footboards.



A. EDGE CUT HAND GRIPS



A. EDGE CUT HAND GRIPS



B. EDGE CUT BRAKE PEDAL PADS



C. EDGE CUT FOOTPEGS & SHIFTER PEG



D. EDGE CUT RIDER FOOTBOARD INSERTS – TRADITIONAL STYLE (SHOWN WITH LARGE EDGE CUT BRAKE PEDAL PAD)



D. EDGE CUT PASSENGER FOOTBOARD INSERTS – CLASSIC STYLE



E. CHROME AND RUBBER HAND GRIPS

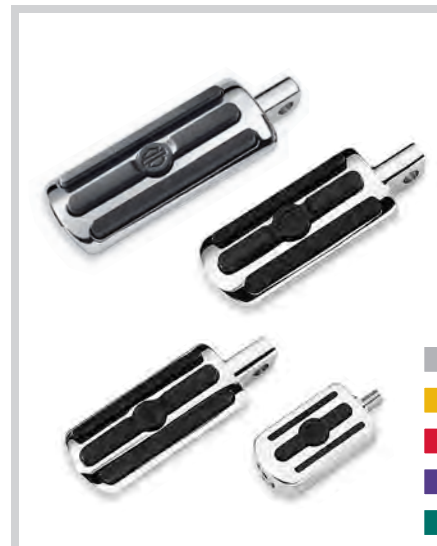

F. CHROME AND RUBBER CUSTOM FOOTPEGS AND SHIFTER PEG

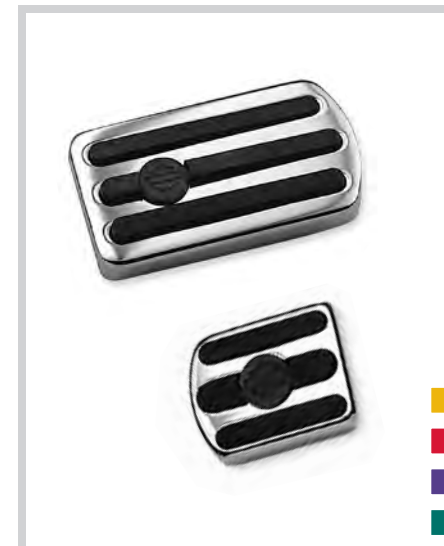

G. CHROME AND RUBBER BRAKE PEDAL PADS



H. CHROME AND RUBBER RIDER FOOTBOARD INSERTS – TRADITIONAL SHAPE (SHOWN WITH BRAKE PEDAL PAD)



H. CHROME AND RUBBER PASSENGER FOOTBOARD INSERTS – TRADITIONAL SHAPE

CONTROLS 495

Hand & Foot Controls Collection

CHROME AND RUBBER COLLECTION

Chrome and rubber both have their distinct places in the world of motorcycle styling. It seemed natural to bring the two together to create this unique collection.

E. CHROME AND RUBBER HAND GRIPS

Designed to match the Chrome and Rubber Footboard Inserts and Brake Pedal Pads, these grips are made from an injected rubber molding process that combines chromed steel and durable rubber.

Fits '02-'17 VRSC™, '96-'22 XL, '08-'13 XR, '91-'17 Dyna® (except FXDLS), '96-'15 Softail® (except FLSTNSE, FXSBSE and '11-'12 FLSTSE) and '96-'07 Touring models.

56246-96A Small. \$96.95

56263-96A Large. \$96.95

Fits '20-later LiveWire®, '16-'17 Dyna FXDLS and '16-later Softail models, '11-'12 FLSTSE, '14-'15 FLSTNSE, '13-'14 FXSBSE, '16-'17 FXSE and '08-later Touring (except '18-'19 FLTRXSE) and Trike models.

56246-08 Small. \$96.95

56263-08 Large. \$96.95

F. CHROME AND RUBBER CUSTOM FOOTPEGS AND SHIFTER PEG

Fits models with H-D® male mount-style footpeg supports (except the rider position on FXCW, FXCWC, FXS, FXSB, FXSBSE and FXSE, '15-latter XG, '06-'17 Dyna, '03-later Sportster®, and '18-later Softail models).

50500-03 Oversize. \$95.95

Fits models in passenger and highway peg positions. Does not fit the rider and passenger position for '18-later Softail models.

50130-95A Large. \$90.95

50131-95A Small. \$90.95

Fits all models (except '06-'17 VRSC™ models with forward controls and '08-'13 XR).

34608-95 Shifter Peg. \$33.95

G. CHROME AND RUBBER BRAKE PEDAL PADS

42478-95 Large. \$54.95

Fits '12-'16 FLD, '86-'17 FL Softail and '80-later Touring and Trike models.

42476-95 Small. \$48.95

Fits '15-'20 XG models (except XG750A), '14-'22 XL models with Extended Reach Forward Control Kit P/N 50700030, '93-'17 Dyna models with forward controls, and '84-'17 FX Softail models (except FXSTDSE).

H. CHROME AND RUBBER FOOTBOARD INSERTS

50176-95 Rider – Traditional Shape. \$147.95

Fits '12-'16 FLD and '86-'17 FL Softail, and '86-later Touring and Trike models equipped with traditional-shaped rider footboards.

50177-95 Passenger – Traditional Shape. \$127.95

Fits models equipped with traditional-shaped passenger footboards.

Model Family Fitment:

V-ROD
 SPORTSTER
 DYNA
 SOFTAIL
 TOURING

Notice: The prices appearing in this catalog are the manufacturer's suggested retail prices. Actual retail prices may vary.

Notice: The prices appearing in this catalog are the manufacturer's suggested retail prices. Actual retail prices may vary.

CONTROLS

496 CONTROLS

Hand & Foot Controls Collection

DIAMOND BLACK COLLECTION

Shroud your bike in mystery. This blacked-out hand and foot control collection features distinctive knurled surfaces that expose the raw billet aluminum for a dramatic contrast. Designed to age and “break in” like a pair of comfortable stone-washed jeans, the satin black finish will complement both high-gloss and denim paint colors. The narrow rubber bands and the knurled surfaces provide a positive grip.

A. DIAMOND BLACK HAND GRIPS

Hand grips are a comfortable diameter and feature glueless installation that can be easily removed for service without damage.

56405-08 **\$108.95**
Fits '02-'17 VRSC™, '96-'22 XL '08-'13 XR, '91-'17 Dyna® (except FXDLS), '96-'15 Softail® (except FLSTNSE, FXSBSE and '11-'12 FLSTSE) and '96-'07 Touring models.

56746-08 **\$108.95**
Fits '20-later LiveWire®, '16-'17 Dyna FXDLS and '16-later Softail models, '11-'12 FLSTSE, '14-'15 FLSTNSE, '13-'14 FXSBSE, '16-'17 FXSE and '08-later Touring (except '18-'19 FLTRXSE) and Trike models.

B. DIAMOND BLACK FOOTPEGS AND SHIFTER PEG

The slim footpeg design allows a comfortable pivot point and the wide surface and large diameter end cap keep your boot in place.

1. 50911-08A Footpegs – Small Diameter. **\$90.95**
Fits models with H-D® male mount-style footpeg supports (except the rider position on '17-later XG750A, '07-'10 XL883L, '07-'22 XL883N, XL1200N, XL1200T, XL1200V and XL1200X, '11-'22 XL1200C, '16-'22 XL1200CX, '17-'22 XL1200CP and XL1200CA, '08-'13 XR and '08-'17 FXCW, FXCWC, FXS, FXSB, FXSBSE and FXSE and the rider and passenger position on '18-later Softail models).

2. 50500035 Footpegs with Styled Wear Peg. **\$90.95**
Fits '11-'22 XL883L and XL1200C, '16-'22 XL1200CX, '12-'16 XL1200V, '10-'22 XL1200X, '18-'22 XL1200XS, '14-'22 XL models equipped with Extended Reach Forward Control Conversion Kit P/N 50700030, '08-'11 FXCW and FXCWC, '11-'17 FXS and FXSB, and '16-'17 FXSE models.

3. 34690-08 Shifter Peg. **\$33.95**
Fits all models (except '06-'17 VRSC models with forward controls and '08-'13 XR).

C. DIAMOND BLACK BRAKE PEDAL PADS

Available in two sizes, these brake pedal pads complete the clean, custom black billet look.

41850-08 Small. **\$48.95**
Fits '15-'20 XG models (except XG750A), '14-'22 XL models with Extended Reach Forward Control Kit P/N 50700030, '93-'17 Dyna models with forward controls, and '84-'17 FX Softail models (except FXSTDSE).



A. DIAMOND BLACK HAND GRIPS



B. DIAMOND BLACK FOOTPEGS AND SHIFTER PEG (34690-08 SHOWN)



B. DIAMOND BLACK FOOTPEGS AND SHIFTER PEG



C. DIAMOND BLACK BRAKE PEDAL PADS



D. SMALL DIAMETER HAND GRIPS



E. GET-A-GRIP HAND GRIPS – CHROME



E. GET-A-GRIP HAND GRIPS – BLACK



F. NOSTALGIC HAND GRIPS

CONTROLS 497

Hand Grips

D. SMALL DIAMETER HAND GRIPS – BLACK RUBBER

Original Equipment on the FLHTKL, Ultra Limited Low models, these Small Diameter Black Rubber Grips feature smooth surfaces and a clean design that complements any styling direction.

56100355 **\$33.95**
Fits '08-later Touring and '09-later Trike models.

E. GET-A-GRIP™ HAND GRIPS

Dressed in tactified rubber for superior traction, these elegant hand grips provide a positive connection to the controls in wet or dry weather. The soft touch cross-hatched rubber surface feels good against both gloved and bare skin and the “thicker in the middle” profile forms a natural fit with your closed fist. Shaped for maximum comfort, Get-A-Grip™ hand grips are available in your choice of standard or magnum diameters to comfortably accommodate almost any size hand. And you don't need to sacrifice style for comfort. Designed to accent any customizing direction, the mirror chrome or gloss black finishes complement both traditional and contemporary looks. The easy-to-install glueless design allows you to remove the grips for service without damage.

Fits '02-'17 VRSC™, '96-'22 XL, '08-'13 XR, '91-'17 Dyna® (except FXDLS), '96-'15 Softail® (except FLSTNSE, FXSBSE and '11-'12 FLSTSE) and '96-'07 Touring models.

56100007	Chrome, Standard 1.5" Diameter.	\$96.95
56100009	Chrome, Magnum 1.6" Diameter.	\$96.95
56100008	Black, Standard 1.5" Diameter.	\$96.95
56100010	Black, Magnum 1.6" Diameter.	\$96.95

Fits '20-later LiveWire®, '16-'17 Dyna FXDLS and '16-later Softail models, '11-'12 FLSTSE, '14-'15 FLSTNSE, '13-'14 FXSBSE, '16-'17 FXSE and '08-later Touring (except '18-'19 FLTRXSE) and Trike models.

56100015	Chrome, Magnum 1.6" Diameter.	\$96.95
56100036	Black, Magnum 1.6" Diameter.	\$96.95

F. NOSTALGIC HAND GRIPS

Comfortable hourglass style with a chrome accent ring and a molded-in Harley-Davidson logo. These rubber grips were inspired by Harley-Davidson® motorcycles of the 1940s.

56275-96B **\$75.95**
Fits '02-'17 VRSC, '96-'22 XL, '08-'13 XR, '91-'17 Dyna (except FXDLS), '96-'15 Softail (except FLSTNSE, FXSBSE and '11-'12 FLSTSE) and '96-'07 Touring models.

56275-08 **\$75.95**
Fits '20-later LiveWire, '16-'17 Dyna FXDLS and '16-later Softail models, '11-'12 FLSTSE, '14-'15 FLSTNSE, '13-'14 FXSBSE, '16-'17 FXSE and '08-later Touring (except '18-'19 FLTRXSE) and Trike models.

Model Family Fitment:

V-ROD	SPORTSTER	DYNA
SOFTAIL	TOURING	

Notice: The prices appearing in this catalog are the manufacturer's suggested retail prices. Actual retail prices may vary.

Notice: The prices appearing in this catalog are the manufacturer's suggested retail prices. Actual retail prices may vary.

498 CONTROLS

Hand Grips – Heated

HEATED HAND GRIPS

Keep comfortable on those cool mornings or frigid night rides. Warm hands have a major impact on overall body comfort and sometimes gloves just aren't enough. These thermostatically controlled grips feature variable heat settings controlled with a military-grade resistor and use automatic temperature monitoring to adjust to ambient temperatures. With both hands on the grips, they will remain at a constant temperature regardless of changes in outside temperature. The self-contained control circuit and control knob means you have no additional switches or controller boxes to mount and the grips are switched on/off with the ignition to avoid draining your battery. The glueless grip design allows grip removal if you change handlebars or motorcycles.

A. AIRFLOW HEATED HAND GRIPS

Fits '16-'17 Dyna® FXDLS, '16-later Softail®, and '08-later Touring and Trike models. '16-'17 Softail models require separate purchase of Electrical Connection Kit P/N 72673-11. '14-'16 Touring and Trike models require separate purchase of Electrical Connection Kit P/N 69200722. '18-later Softail and '17-later Touring and Trike models require Electrical Connection Kit P/N 69201599A. Does not fit '08-'13 models with internally wired handlebars. The power wires for these grips must be wired internal of the handlebar. See accessory handlebars for specific heated hand grip exclusions. Airflow Grips P/N 56100342 are stock on '18 FLHTKSE and FLHXSE models. Kahuna™ Grips P/N 56100318 are stock on '18 FLHXSE, '20 FLHTCUTGSE and '21 FLHTCUTGSE, FLHTKSE, FLHXSE and FLTRXSE models. Kahuna Grips P/N 56100331 are stock on '19 FLHTKSE, FLHXSE, '20 FLHTKSE, FLHXSE, FLTRXSE, '21 FLHTCUTGSE, FLHXSE, FLTRXSE, '22 FLHXSE, FLTRKSE and FLTRXSE models.

56100253	Chrome.	\$310.95
56100342	Gloss Black.	\$310.95

Fits '02-'17 VRSC™, '96-'22 XL, '08-'13 XR, '96-'17 Dyna (except FXDLS) and '96-'15 Softail (except FLSTSE, FLSTNSE, and FXSBSE) and '96-'07 Touring models. '14-'22 XL, '12-'17 Dyna and '11-'15 Softail models require separate purchase of Electrical Connection Kit P/N 72673-11. Does not fit '08-'13 models with internally wired handlebars. The power wires for the Chrome grips must be wired internal of the handlebar. Gloss Black grip can be wired internally. See accessory handlebars for specific heated hand grip exclusions.

56100256	Chrome.	\$310.95
56100358	Gloss Black.	\$310.95

B. HEATED HAND GRIPS – COLLECTIONS

Styled to complement Harley-Davidson® hand and foot control collections, these thermostatically controlled heated hand grips will keep you comfortable on a cool weather ride

Fits '16-'17 Dyna FXDLS, '16-later Softail, and '08-later Touring and Trike models. '16-'17 Softail models require separate purchase of Electrical Connection Kit P/N 72673-11. '14-'16 Touring and Trike models require separate purchase of Electrical Connection Kit P/N 69200722. '18-later Softail and '17-later Touring and Trike models require Electrical Connection Kit P/N 69201599A. Does not fit '08-'13 models with internally wired handlebars. The power wires for these grips must be wired internal of the handlebar. See accessory handlebars for specific heated hand grip exclusions. Airflow Grips P/N 56100342 are stock on '18 FLHTKSE and FLHXSE models. Kahuna Grips P/N 56100318 are stock on '18 FLHXSE, '20 FLHTCUTGSE and '21 FLHTCUTGSE, FLHTKSE, FLHXSE and FLTRXSE models. Kahuna Grips P/N 56100331 are stock on '19 FLHTKSE, FLHXSE, '20 FLHTKSE, FLHXSE, FLTRXSE, '21 FLHTCUTGSE, FLHXSE, FLTRXSE, '22 FLHXSE, FLTRKSE and FLTRXSE models.

56100318	Kahuna – Chrome.	\$310.95
56100331	Kahuna – Gloss Black.	\$310.95
56100437	Empire™ – Black.	\$310.95
56100436	Empire – Chrome.	\$310.95
56100438	Empire – Machine Cut.	\$322.95



A. AIRFLOW HEATED HAND GRIPS – CHROME



A. AIRFLOW HEATED HAND GRIPS – BLACK



B. KAHUNA HEATED HAND GRIPS – CHROME



B. KAHUNA HEATED HAND GRIPS – GLOSS BLACK



C. EMPIRE HEATED HAND GRIPS – BLACK



C. EMPIRE HEATED HAND GRIPS – CHROME



C. EMPIRE HEATED HAND GRIPS – MACHINE CUT



C. STREAMLINER HEATED HAND GRIPS – CHROME



D. HEATED HAND GRIPS – BLACK RUBBER



E. WILLIE G SKULL HEATED HAND GRIPS – BLACK



E. CHROME AND RUBBER HEATED HAND GRIPS



C. STREAMLINER HEATED HAND GRIPS – BLACK



E. CONTOURED HEATED HAND GRIPS



E. WILLIE G SKULL HEATED HAND GRIPS – CHROME



E. NOSTALGIC HEATED HAND GRIPS

CONTROLS 499

Hand Grips – Heated

C. HEATED HAND GRIPS – STREAMLINER

Complement the Streamliner look with these matching grips. The rich black rubber provides a positive grip while riding and the chrome tri-line design will provide just the right touch of chrome. These grips have been thermally mapped to provide more uniform heat and are designed to achieve a maximum operating temperature approximately 20° Fahrenheit warmer than previous accessory heated grips for added warmth during cold rides.

Fits '16-'17 Dyna® FXDLS, '16-later Softail®, and '08-later Touring and Trike models. Does not fit CVO™ models (except FXSE). '16-'17 Softail models require separate purchase of Electrical Connection Kit P/N 72673-11. '14-'16 Touring and Trike models require separate purchase of Electrical Connection Kit P/N 69200722. '18-later Softail and '17-later Touring and Trike models require Electrical Connection Kit P/N 69201599A. Does not fit '08-'13 models with internally wired handlebars. The power wires for these grips must be wired external of the handlebar. See accessory handlebars for specific heated hand grip exclusions.

56100255	Chrome.	\$310.95
56100412	Black.	\$310.95

D. HEATED HAND GRIPS – BLACK RUBBER

Original Equipment on the FLHTK Ultra Limited model, these Black Rubber Heated Grips feature smooth surfaces and a clean design that complements any styling direction.

56100034 **\$227.95**

Fits '16-'17 Dyna® FXDLS, '16-later Softail® and '08-later Touring and Trike models with Original Equipment Stainless Steel handlebars. Does not fit CVO™ models or models with chrome handlebars. '16-later Softail® models require separate purchase of Electrical Connection Kit P/N 72673-11. '14-'16 Touring and Trike models require separate purchase of Electrical Connection Kit P/N 69200722. '17-later Touring and Trike models require Electrical Connection Kit P/N 69201599A. Does not fit '08-'13 models with internally wired handlebars.

E. HEATED HAND GRIPS – COLLECTIONS

Styled to complement Harley-Davidson® hand and foot control collections, these thermostatically controlled heated hand grips will keep you comfortable on a cool weather ride

Fits '16-'17 Dyna FXDLS, '16-later Softail, and '08-later Touring and Trike models. Does not fit CVO models (except FXSE). '16-'17 Softail models require separate purchase of Electrical Connection Kit P/N 72673-11. '14-'16 Touring and Trike models require separate purchase of Electrical Connection Kit P/N 69200722. '18-later Softail and '17-later Touring and Trike models require Electrical Connection Kit P/N 69201599A. Does not fit '08-'13 models with internally wired handlebars. The power wires for these grips must be wired external of the handlebar. See accessory handlebars for specific heated hand grip exclusions.

56100257	Contoured.	\$310.95
56100362	Willie G Skull – Black.	\$310.95
56100260	Willie G Skull – Chrome.	\$310.95
56100267	Chrome and Rubber – Small.	\$310.95

Fits '02-'17 VRSC™, '96-'22 XL, '08-'13 XR, '91-'17 Dyna (except FXDLS) and '96-'15 Softail (except FLSTSE, FLSTNSE, and FXSBSE) and '96-'07 Touring models. '14-'22 XL, '12-'17 Dyna and '11-'15 Softail models require separate purchase of Electrical Connection Kit P/N 72673-11. Does not fit '96-'13 models with internally wired handlebars or FXDB models with Original Equipment handlebars. The power wires for these grips must be wired external of the handlebar. See accessory handlebars for specific heated hand grip exclusions.

56100268	Contoured.	\$310.95
56100363	Willie G Skull – Black.	\$310.95
56100259	Willie G Skull – Chrome.	\$310.95
56100266	Chrome and Rubber – Small.	\$310.95
56100264	Chrome and Rubber – Large.	\$310.95
56100261	Nostalgic.	\$310.95

Model Family Fitment:

■ V-ROD	■ SPORTSTER	■ DYNA
■ SOFTAIL	■ TOURING	

Notice: The prices appearing in this catalog are the manufacturer's suggested retail prices. Actual retail prices may vary.

Notice: The prices appearing in this catalog are the manufacturer's suggested retail prices. Actual retail prices may vary.

500 CONTROLS

Footpegs

A. MINI FOOTBOARD KIT

This footboard kit can be installed in place of traditional footpegs and provides a little additional leg support and more options to move your legs around on a long ride. Mini Footboards mount to the standard H-D® style footpeg supports and can be used in many rider, passenger and highway applications. Sole-gripping rubber complements Original Equipment or accessory footboards and footpegs and adds vibration isolation and a rich appearance.

Fits rider position:

'02-'17 VRSC™ models with forward controls (except VRSCDX and VRSCF), '15-'20 XG models (except XG750A), '06-earlier XL, '07-'10 XL883, XL883R, XL883C, XL1200C and XL1200R and '07-'11 XL1200L, '91-'17 Dyna® (except FLD) and '84-'17 Softail® models with forward controls (except FXCW, FXCWC, FXS, FXSB or FXSBSE).

Fits passenger position:

All models with H-D® male-mount passenger peg mounts (except '06-earlier VRSC, '03-earlier XL, '05-earlier Dyna and Softail models equipped with Shotgun exhaust). '84-'17 Softail models require separate purchase of Support Kit P/N 50454-09. Does not fit passenger position on '18-later Softail models.

Fits highway peg position:

All models with frame-mount or engine guard-mount highway pegs (except Whiskers Adjustable Highway Bar P/N 50855-09 and 50865-09).

50500139	Small 3.0" – Chrome.	\$139.95
50500144	Small 3.0" – Gloss Black.	\$139.95
50500109	Large 4.0" – Chrome.	\$139.95
50500124	Large 4.0" – Gloss Black.	\$139.95

B. ENGINE GUARD MOUNT FOOTPEGS*

Custom engine guard mounted footpegs let you stretch your legs in style. Easy-to-install chrome-plated pegs clamp firmly to the guard. Sold in pairs.

Fits highway peg position on 1.0" and 1.25" engine guards (except VRSC).

49102-86T	Harley Script.	\$43.95
49144-86	Rubber Inserts.	\$45.95



A. MINI FOOTBOARD KIT – LARGE CHROME



A. MINI FOOTBOARD KIT – LARGE GLOSS BLACK



A. MINI FOOTBOARD KIT



C. CUSTOM FOOTPEGS AND SHIFTER PEG



D. O-RING FOOTPEGS AND SHIFTER PEG



B. ENGINE GUARD MOUNT FOOTPEGS – HARLEY SCRIPT



B. ENGINE GUARD MOUNT FOOTPEGS – RUBBER INSERTS



E. LARGE CUSHIONED FOOTPEG KIT

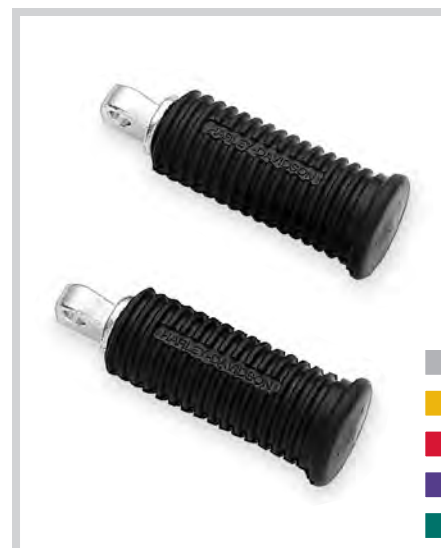

CONTROLS 501

Footpegs

C. CUSTOM FOOTPEGS AND SHIFTER PEG

This footpeg grouping is chrome-plated and features a zinc die-cast body with steel shaft. The black rubber pads have Harley-Davidson graphics molded in for rich detail. Allen® wrench included.

1. 50915-90T Footpegs – Large Diameter. **\$59.95**
Fits models with H-D® male mount-style footpeg supports (except the rider position on '15-later XG, '08-'17 FXCW, FXCWC, FXS, FXSB, FXSBSE and FXSE, '07-'10 XL883L, '07-'22 XL883N, XL1200N, XL1200T, XL1200V and XL1200X, '11-'22 XL1200C, '16-'22 XL1200CX, '17-'22 XL1200CP and XL1200CA and XL1200CA, '18-'22 XL1200NS and XL1200XS, '08-'13 XR and the rider and passenger position on '18-later Softail® models).

2. 50916-90T Footpegs – Small Diameter. **\$54.95**
Fits models with H-D male mount-style footpeg supports (except the rider position on FXCW, FXCWC, FXS, FXSB, FXSBSE and FXSE, '15-later XG, '06-'17 Dyna®, '03-later Sportster®, '07-'10 XL883L, '07-'22 XL883N, XL1200N, XL1200T, XL1200V and XL1200X, '11-'22 XL1200C, '16-'22 XL1200CX, and '17-'22 XL1200CP and XL1200CA and the rider and passenger position on '18-later Softail models).

3. 34635-90T Custom Shifter Peg. **\$23.95**
Fits all models (except '06-'17 VRSC™ models with forward controls and '08-'13 XR).

D. O-RING FOOTPEGS AND SHIFTER PEG

1. 49149-84A Shifter Peg. **\$23.95**
Fits all models (except '06-'17 VRSC models with forward controls, '08-'13 XR models '06-'17 Dyna models with forward controls, FXSE, or LiveWire® models).

2. 49128-82 Footpegs. **\$48.95**
Fits models with H-D male mount-style footpeg supports (except the rider position on FXCW, FXCWC, FXS, FXSB, FXSBSE and FXSE, '15-later XG, '06-'17 Dyna, '03-'22 Sportster, '07-'10 XL883L, '07-'22 XL883N, XL1200N, XL1200T, XL1200V and XL1200X, '11-'22 XL1200C, '16-'22 XL1200CX, and '17-'22 XL1200CP and XL1200CA and the rider and passenger position on '18-later Softail models).

E. LARGE CUSHIONED FOOTPEG KIT

Large-diameter footpegs feature cushioned rubber tread for sure-footed comfort.

49110-98 **\$48.95**
Fits models with H-D male mount-style footpeg supports (except the rider position on '17-later XG750A, '07-'10 XL883L, '07-'22 XL883N, XL1200N, XL1200T, XL1200V and XL1200X, '11-'22 XL1200C, '16-'22 XL1200CX, '18-'22 XL1200NS and XL1200XS, '08-'13 XR and '08-'17 FXCW, FXCWC, FXS, FXSB, FXSBSE, FXSE and the rider and passenger position on '18-later Softail models).

Model Family Fitment:

- V-ROD
- SPORTSTER
- DYNA
- SOFTAIL
- TOURING



***WARNING:** Do not use engine guard footpegs under normal stop and go operating conditions. Doing so could result in death or serious injury.

Notice: The prices appearing in this catalog are the manufacturer's suggested retail prices. Actual retail prices may vary.

Notice: The prices appearing in this catalog are the manufacturer's suggested retail prices. Actual retail prices may vary.

502 CONTROLS

Highway Pegs

A. BILLET ENGINE GUARD FOOTPEG MOUNTING KIT*

Here's a stylish way to get your feet into the wind. This beautifully polished Billet Aluminum Footpeg Mount Kit installs easily on your engine guard and lets you stretch your legs on cross-country rides. Available in your choice of chrome or gloss black finishes. Works with all H-D® style male-mount footpegs.

Fits front engine guards with 1.25" diameter tubing (except VRSC™ Engine Guard P/N 49267-01A, 49388-09, XL Engine Guard P/N 49060-04, 49287-11, 49215-07 or Softail® Nostalgic Engine Guard P/N 49037-05A). Does not fit with Chopped Engine Guards.

50957-02C	Chrome.	\$107.95
54234-10A	Gloss Black.	\$107.95

B. ADJUSTABLE HIGHWAY PEG MOUNTING KIT – ANGLED*

Stretch out for added comfort. This Adjustable Highway Peg Mounting Kit can be set for shorter riders and it can be reversed to reach far forward for those with long legs. The angled design allows the arm to reach back and around to clear fairing lowers. The arm can be raised and lowered for a custom fit. The mounting clamp firmly grips the engine guard and the locking design secures the peg at the desired angle. Available in mirror chrome or gloss black finishes, the complete kit includes matching mounting hardware. Footpegs sold separately.

Fits 1.25" engine guards. Does not fit with Chopped Engine Guards.

50829-07A	5.0" Long Angled – Chrome.	\$142.95
50830-07A	2.5" Short Angled – Chrome.	\$142.95
50500167	5.0" Long Angled – Gloss Black.	\$142.95
50500168	2.5" Short Angled – Gloss Black.	\$142.95



A. BILLET ENGINE GUARD FOOTPEG MOUNTING KIT – CHROME



A. BILLET ENGINE GUARD FOOTPEG MOUNTING KIT – GLOSS BLACK



B. ADJUSTABLE HIGHWAY PEG MOUNTING KIT – LONG ANGLED – CHROME



B. ADJUSTABLE HIGHWAY PEG MOUNTING KIT – SHORT ANGLED – CHROME



B. ADJUSTABLE HIGHWAY PEG MOUNTING KIT – LONG ANGLED – GLOSS BLACK



B. ADJUSTABLE HIGHWAY PEG MOUNTING KIT – SHORT ANGLED – GLOSS BLACK



***WARNING:** Do not use engine guard footpegs under normal stop and go operating conditions. Doing so could result in death or serious injury.

Model Family Fitment:

■ V-ROD	■ SPORTSTER	■ DYNA
■ SOFTAIL	■ TOURING	

Notice: The prices appearing in this catalog are the manufacturer's suggested retail prices. Actual retail prices may vary.

CONTROLS 503

Highway Pegs

C. ADJUSTABLE HIGHWAY PEG MOUNTING KIT – 360°*

Change your foot position for added comfort on long stretches of open road. The 360° Adjustable Highway Peg can be rotated and locked in a wide range of positions to accommodate both the tall and short rider. The chrome-plated clamp holds its place on the engine guard and the arm locks the peg securely in position. Kit includes chrome-plated mount, arm and installation hardware. Footpegs sold separately.

50832-07A	3.0" Short Offset.	\$142.95
Fits 1.25" engine guards. Does not fit with Chopped Engine Guards.		



C. ADJUSTABLE HIGHWAY PEG MOUNTING KIT – 360°



D. ENGINE GUARD FOOTPEG MOUNTING KIT



E. ENGINE GUARD FOOTPEG MOUNT CHROME HARDWARE KIT



F. BULLET TIP FOOTPEG BOLT KIT – CHROME



G. FOOTPEG MOUNTING HARDWARE KIT – CHROME



H. FOOTPEG MOUNTING PINS – POLISHED



I. ADJUSTABLE PASSENGER FOOTPEG MOUNT KIT

D. ENGINE GUARD FOOTPEG MOUNTING KIT*

Allows easy installation of any H-D® male mount-style footpegs on to H-D front engine guards. All pieces necessary are included in the kit, with no extra hardware to buy.

50964-98		\$48.95
Fits 1.25" engine guards (except VRSC™ Guard P/N 49267-01A, 49388-09, XL Engine Guard P/N 49060-04 or 49215-07 or Softail® Nostalgic Engine Guard P/N 49037-05A). Does not fit with Chopped Engine Guards.		

E. ENGINE GUARD FOOTPEG MOUNT CHROME HARDWARE KIT*

Jump from zinc to chrome with this chrome-plated hardware kit, which replaces the standard hardware in Engine Guard Footpeg Mounting Kit P/N 50964-98. Made to Original Equipment standards for unmatched quality, the bolts bear the Harley-Davidson mark to signify they're the genuine article.

94140-02		\$23.95
Fits Engine Guard Footpeg Mounting Kit P/N 50964-98.		

F. BULLET TIP FOOTPEG BOLT KIT – CHROME

Put the final touch on a custom footpeg installation with this chrome Bullet Tip Footpeg Bolt Kit. Sold in pairs, this accessory includes chrome button head bolts, washers and uniquely styled nuts. All hardware is developed to Original Equipment standards to ensure product quality.

94133-01		\$29.95
Fits male mount-style footpegs (except '08-'13 XR models).		

G. FOOTPEG MOUNTING HARDWARE KIT – CHROME

Polished and chrome-plated hex head bolts replace the Original Equipment footpeg mounting hardware for a truly finished look. Kit includes two chrome-plated bolts and lock nuts with nylon inserts. The bolts carry a Harley-Davidson Bar & Shield proof mark. All hardware is developed to Original Equipment standards to ensure product quality.

94139-01		\$18.95
Fits male mount-style footpegs (except FLSTSE and '08-'13 XR models).		

H. FOOTPEG MOUNTING PINS – POLISHED

Stainless steel for rust and corrosion resistance. Polished for good looks. Replaces Original Equipment footpeg mounting hardware.

42679-01		\$15.95
Fits male mount-style footpegs (except '08-'13 XR models).		

I. ADJUSTABLE PASSENGER FOOTPEG MOUNT KIT

Maximize your passenger's riding comfort. Proper foot position reduces the cramped or stretched-out feeling and relieves pressure on the knees and the tailbone. These Adjustable Mounts raise and lower the passenger footpeg to accommodate taller and shorter passengers. Easy to adjust with common tools, the mount adjusts through a 360° range (depending on model), allowing both fore and aft and up and down height adjustment. Kit includes left and right adjustable support assembly and all required mounting hardware. Footpegs sold separately.

50763-09		\$160.95
Fits models with H-D® models male mount-style passenger footpeg supports (except Softail®). Does not fit with Heel Raiser Footpeg Kit P/N 50178-09. Does not fit the rider position.		



***WARNING:** Do not use engine guard footpegs under normal stop and go operating conditions. Doing so could result in death or serious injury.

Notice: The prices appearing in this catalog are the manufacturer's suggested retail prices. Actual retail prices may vary.

504 CONTROLS

Footboards

CUSTOM FOOTBOARDS

To add style to your ride, install custom footboard inserts that match the shape of your Original Equipment footboards. To radically change the look, select footboard pans in a new shape or finish and add coordinating inserts that highlight your custom direction.

A. SWEEP WING RIDER FOOTBOARD PANS

Add a sleek tapered look to your footboard-equipped model. These Sweep Wing Pans are installed using the Original Equipment mounts and hardware. Add your choice of Sweep-Wing Shaped footboard inserts (sold separately).

Fits '12-'16 FLD and '86-'17 FL Softail® (except FLS, FLSS, FLSTFB and FLSTFBS), Touring (except FLHTCUL, FLHTKL and FLHTCUL TC) and Trike models.

50683-04	Chrome Right.	\$64.95
50688-04	Chrome Left.	\$64.95
51060-08	Black.	\$107.95



A. SWEEP WING RIDER FOOTBOARD PANS (CHROME SHOWN)



B. BLACK RIDER FOOTBOARD PANS - TRADITIONAL STYLE



C. HALF-MOON RIDER FOOTBOARDS - POLISHED STAINLESS STEEL



C. HALF-MOON RIDER FOOTBOARDS - GLOSS BLACK



D. PASSENGER FOOTBOARD PANS - CHROME, CLASSIC STYLE



D. PASSENGER FOOTBOARD PANS - CHROME, CONTEMPORARY STYLE



E. PASSENGER FOOTBOARD PANS - BLACK, CLASSIC STYLE



E. PASSENGER FOOTBOARD PANS - BLACK, CONTEMPORARY STYLE



F. TRADITIONAL PASSENGER FOOTBOARD PANS - CHROME

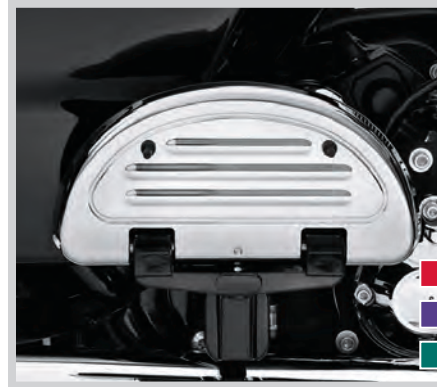

H. HALF-MOON PASSENGER FOOTBOARD PANS - CHROME

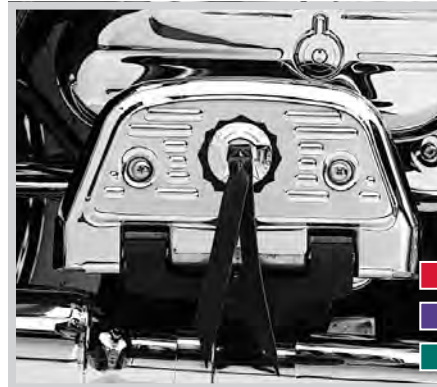

I. CONCHO PASSENGER FOOTBOARD COVERS



K. ROAD KING CLASSIC PASSENGER FOOTBOARD COVERS



G. SWEEP WING PASSENGER FOOTBOARD PANS (GROOVED SHOWN)



H. HALF-MOON PASSENGER FOOTBOARD PANS - GLOSS BLACK



J. V-LOGO PASSENGER FOOTBOARD COVERS



L. HARLEY-DAVIDSON SCRIPT PASSENGER FOOTBOARD COVERS

B. BLACK RIDER FOOTBOARD PANS

Complete the blacked-out transformation. Replace the Original Equipment chrome footboard pans with sinister gloss black. Kit includes both the right and left pan and is installed using the Original Equipment hardware and insert pad. Custom footboard inserts are sold separately.

51322-08 Traditional Shape. **\$107.95**
Fits '12-'16 FLD and '86-'17 FL Softail (except FLS, FLSS, FLSTFB and FLSTFBS), Touring (except FLHTCUL, FLHTKL and FLHTCUL TC) and Trike models.

C. HALF-MOON RIDER FOOTBOARDS

Combine the style of the '40s with the comfort of today. The classic half moon-shaped rider footboards are available in polished stainless steel or gloss black finish to complement your styling direction. The traditional "Harley-Davidson" rubber insert features a vibration-isolation design for a long, comfortable ride. Kit includes left and right footboard pans and matching rubber inserts.

Fits '86-'17 FL Softail models.

51345-08	Polished Stainless Steel.	\$165.95
51400-08	Gloss Black.	\$165.95

D. PASSENGER FOOTBOARD PANS - CHROME

Replace the factory black painted passenger footboard with the custom look of smooth chrome. These chrome-plated Footboard Pans are ready to install using your Original Equipment hardware and the kit includes left- and right-side Footboard Pans. Just add your choice of Footboard Insert for the finishing touch. Footboard Supports sold separately.

Fits '06-'17 Dyna®, '18-later Softail (except FXDRS, FXFB and FXFBS) and '86-later Touring models equipped with passenger footboard supports. Does not fit Trike models.

50501144	Classic Style.	\$180.95
50501147	Contemporary Style.	\$180.95

E. PASSENGER FOOTBOARD PANS - BLACK

Complete the blacked-out transformation. Replace your chrome Passenger Footboard Pans with sinister black. Kit includes left- and right-side Footboard Pans and is installed using the Original Equipment hardware. Custom Footboard Inserts and Footboard Supports sold separately.

Fits '06-'17 Dyna, '18-later Softail (except FXDRS, FXFB and FXFBS) and '86-later Touring models equipped with passenger footboard supports. Does not fit Trike models.

50501610	Classic Style.	\$180.95
50501611	Contemporary Style.	\$180.95

Model Family Fitment:

V-ROD	SPORTSTER	DYNA
SOFTAIL	TOURING	

Notice: The prices appearing in this catalog are the manufacturer's suggested retail prices. Actual retail prices may vary.

CONTROLS 505

Footboards

F. TRADITIONAL PASSENGER FOOTBOARD PANS - CHROME

Replace the factory black painted passenger footboard with the custom look of smooth chrome. The kit includes left- and right-hand traditional D-shaped footboard pans, chrome-plated and ready to install with your Original Equipment hardware. Just add your choice of footboard insert for the finishing touch. Footboard supports sold separately.

50752-04 **\$180.95**
Fits '06-'17 Dyna®, '00-later Softail® (except FXDRS, FXFB and FXFBS) and '86-later Touring and Trike models equipped with passenger footboard supports.

G. SWEEP WING PASSENGER FOOTBOARD PANS

These unique Sweep Wing Passenger Footboard Pans complement the Sweep Wing Rider Footboard shape and allow you to replace the Original Equipment passenger footpegs on certain models with footboards. When folded, the footboard displays a mirror chrome surface in your choice of smooth or ball-milled grooved design. Footboard inserts and footboard supports sold separately.

Fits '06-'17 Dyna, '00-later Softail (except FXDRS, FXFB and FXFBS) and '86-later Touring models equipped with passenger footboard supports. Does not fit Trike models.

50357-04	Chrome - Grooved.	\$180.95
50716-04	Chrome - Smooth.	\$180.95

H. HALF-MOON PASSENGER FOOTBOARD PANS AND INSERTS

Styled to match the Half-Moon Rider Footboards, these classic passenger footboards add both style and comfort to your nostalgic ride. Available in mirror chrome or gloss black finish, the kit includes left and right footboard pan and vibration-isolation footboard inserts. Model-specific footboard mounts are sold separately.

Fits '06-'17 Dyna, '00-later Softail (except FXDRS, FXFB and FXFBS) and '86-later Touring models equipped with passenger footboard supports. Does not fit Trike models.

50807-08	Chrome.	\$221.95
50810-08	Gloss Black.	\$209.95

I. CONCHO PASSENGER FOOTBOARD COVERS

Heritage Softail® Classic-inspired conchos make these covers look great whether footboards are up or down.

50193-96 **\$84.95**
Fits '06-'17 Dyna, '86-'17 FL Softail and '87-later Touring and Trike models equipped with traditional D-shaped aluminum passenger footboards.

J. V-LOGO PASSENGER FOOTBOARD COVERS

V-Logos are die-cast aluminum integrated with the cover, then chrome-plated for a desirable shine. Includes all mounting hardware.

50194-96 **\$74.95**
Fits '06-'17 Dyna, '86-'17 FL Softail and '87-later Touring and Trike models equipped with traditional D-shaped aluminum passenger footboards.

K. ROAD KING® CLASSIC PASSENGER FOOTBOARD COVERS

The latest in the family of Road King® Classic inspired accessories, this chrome-plated steel footboard cover features a chrome die-cast Road King Classic medallion with black accents and a stylish leather accent piece. Mounting hardware included.

50246-00 **\$84.95**
Fits '06-'17 Dyna, '86-'17 FL Softail and '87-later Touring and Trike models equipped with traditional D-shaped aluminum passenger footboards.

L. HARLEY-DAVIDSON® SCRIPT PASSENGER FOOTBOARD COVERS

These easy-to-install chrome covers are formed to fit over the stock footboard pan to add a touch of style to the profile of your bike. The simple, clean design features a deep embossed Harley-Davidson script for a finishing touch. Kit includes mounting hardware.

50782-91 **\$74.95**
Fits '06-'17 Dyna, '86-'17 FL Softail and '87-later Touring and Trike models equipped with traditional D-shaped aluminum passenger footboards.

Notice: The prices appearing in this catalog are the manufacturer's suggested retail prices. Actual retail prices may vary.

506 CONTROLS

Mirrors

A. FAIRING MOUNT MIRRORS – BLACK*

Fairing Mount Mirrors offer a truly innovative look from the traditional handlebar-mounted mirrors. Mounting just inside the inner fairing, the molded plastic mirror housings complement the contours of the batwing fairing. They provide a wide range of adjustability and feature convex mirror glass that maximizes your field of view. The Bar & Shield logo is carefully laser-etched on each mirror glass. Kit includes necessary hardware, instructions and mounting template for easy installation.

56000076 **\$108.95**
Fits '14-later Electra Glide®, Ultra Limited and Tri Glide® models. Original Equipment on Street Glide models.

91945-98B **\$108.95**
Fits '96-'13 Electra Glide® and Trike models. Original equipment on Street Glide models.



A. FAIRING MOUNT MIRRORS – BLACK



B. FAIRING MOUNT MIRRORS – CHROME

B. FAIRING MOUNT MIRRORS – CHROME*

Add a splash of chrome to the batwing inner fairing. These Fairing Mount Mirrors de-clutter the handlebar and add a contemporary aero style to your ride. The attractive chrome housing provides a custom look and the convex mirror and wide range of adjustment maximizes your field of view. A direct bolt-on replacement for Original Equipment fairing mount mirrors, the kit includes the hardware and mounting template required for easy and accurate installation.

56000077 **\$146.95**
Fits '14-later Electra Glide, Street Glide, Ultra Limited and Tri Glide models.

56000029 **\$146.95**
Fits '96-'13 Electra Glide, Street Glide and Trike models. Original Equipment on '12 FLHXSE models.



C. ILLUMINATED FAIRING MOUNT MIRROR COVERS – CHROME

C. ILLUMINATED FAIRING MOUNT MIRROR COVERS – CHROME

Add auxiliary LED turn signals and a splash of chrome to the inner fairing. The perfect finishing touch to a fully dressed inner fairing, these chrome-plated mirror housings feature fast-acting amber LED turn signals at the outer edge. Side turn signals attract attention from the drivers around you and the plug-in, no-splice design simplifies installation.

56000084 **\$163.95**
Fits '14-later Touring and Trike models with fairing-mount mirrors. Does not fit with Split Vision Fairing Mount Mirrors P/N 92085-10 or Tapered Fairing Mount Mirrors P/N 56000098A or 56000099A.

D. MIRRORS WITH AUXILIARY RUNNING LIGHT AND DIRECTIONAL INDICATOR*

Function and style in one package. This forged mirror combines a traditional swept shape with a contemporary addition – forward-facing auxiliary lighting. Smoked lenses hide bands of amber LED lamps that glow as running lamps when the ignition is on and add a fast-acting auxiliary directional indicator when the turn signals are activated. The forward-facing eye-level lamps command additional attention from oncoming traffic. Both mirrors flash when the emergency hazard lights are activated. The wiring is concealed in the housing and stem and is easily connected to the Original Equipment wiring harness. Available in mirror chrome or satin black finish.

Fits '14-later Touring (except Road King® and Road Glide®) and Tri Glide® models.

56000080 Chrome. **\$352.95**
56000081 Satin Black. **\$352.95**

Fits '97-later models (except VRSCF, XG, XL1200X, XL1200XS, FXDLS, FLSS, FLSTFBS, FXCWC, '18-later Softtail, and '14-later Touring). Also fits '14-later Road King® and '15-later FLRT models.

92059-07A Chrome. **\$347.95**
92068-08A Satin Black. **\$347.95**



D. MIRRORS WITH AUXILIARY RUNNING LIGHT AND DIRECTIONAL INDICATOR – CHROME



D. MIRRORS WITH AUXILIARY RUNNING LIGHT AND DIRECTIONAL INDICATOR – SATIN BLACK

*Harley-Davidson Motor Company cannot test and make specific fitment recommendations concerning every possible mirror and handlebar combination. Therefore, after installing new mirrors or handlebars and before operating the motorcycle, check to ensure that the mirrors provide the operator a clear view to the rear.

Notice: The prices appearing in this catalog are the manufacturer's suggested retail prices. Actual retail prices may vary.

CONTROLS 507

Mirrors

E. '66 COLLECTION MIRRORS

Durable gloss black finish with brushed aluminum highlights. Includes left and right mirrors and mounting hardware. Complete this custom look with additional accessories from the '66 Collection.

56000261 **\$219.95**
Fits '21-later Revolution® Max engine-equipped models. RH975 and RH1250S models require separate purchase of Handlebar End Cap P/N 55801095, 55900246, 55900247 or 55900248.

56000262 **\$219.95**
Fits '82-later models (except VRSCF, XG750A, '14-'16 FLHR, FLHRC and FLHRSE, '14-later FLHTKSE, '18-later FLTRXSE and Revolution Max models). Street Glide® models require separate purchase of Fairing Plug Kit P/N 57300063. Does not fit XL1200X with mirrors mounted below the handlebar.

F. ADVERSARY™ COLLECTION MIRRORS

A look to match your riding style – precise, refined and technical. Premium Adversary™ Collection accessories are crafted in forged billet aluminum with a durable dual-anodized black and orange finish for crisp contrast and colorful detail. The look is aggressive and performance driven. Step up to the next generation of customization..

Fits '82-later models (except VRSCF, XG750A, '14-'16 FLHR, FLHRC and FLHRSE, '14-later FLHTKSE, '18-later FLTRXSE and Revolution Max models). Street Glide models require separate purchase of Fairing Plug Kit P/N 57300063. Does not fit XL1200X with mirrors mounted below the handlebar.

56000280 Black w/ Orange Highlights. **\$219.95**
56000279 Graphite w/ Machined Highlights. **\$209.95**

Fits '21-later Revolution® Max engine-equipped models. RH975 and RH1250S models require separate purchase of Handlebar End Cap P/N 55801095, 55900246, 55900247 or 55900248.

56000224 Black w/ Orange Highlights. **\$219.95**
56000225 Graphite w/ Machined Highlights. **\$199.95**

G. EMPIRE COLLECTION MIRRORS

Raise the stakes. Deep grooves add eye-catching depth and detail to the rich black anodized finish on this complete collection of custom accessories. Executed in durable cast and billet aluminum, the Empire™ Collection adds captivating custom detail that complements other Empire accessories..

Fits '21-later Revolution® Max engine-equipped models. RH975 and RH1250S models require separate purchase of Handlebar End Cap P/N 55801095, 55900246, 55900247 or 55900248.

56000221 Machine Cut. **\$244.95**
56000220 Black. **\$234.95**

Fits '82-later models (except VRSCF, XG750A, '14-'16 FLHR, FLHRC and FLHRSE, '14-later FLHTKSE, '18-later FLTRXSE and Revolution Max models). Street Glide models require separate purchase of Fairing Plug Kit P/N 57300063. Does not fit XL1200X with mirrors mounted below the handlebar.

56000305 Machine Cut. **\$244.95**
56000294 Black. **\$234.95**
56000301 Chrome. **\$234.95**

*Harley-Davidson Motor Company cannot test and make specific fitment recommendations concerning every possible mirror and handlebar combination. Therefore, after installing new mirrors or handlebars and before operating the motorcycle, check to ensure that the mirrors provide the operator a clear view to the rear.

Model Family Fitment:

V-ROD
 SPORTSTER
 DYNA

 SOFTAIL
 TOURING

Notice: The prices appearing in this catalog are the manufacturer's suggested retail prices. Actual retail prices may vary.



E. '66 COLLECTION MIRRORS

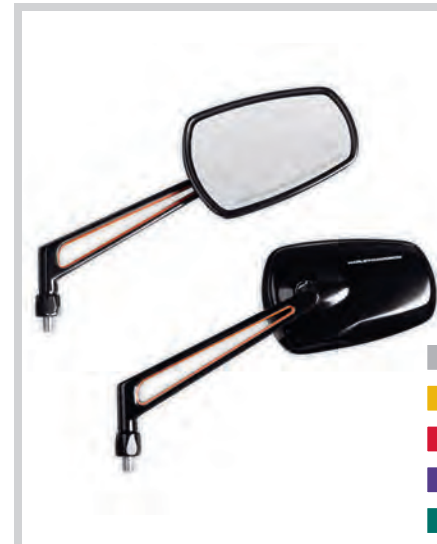

F. ADVERSARY COLLECTION MIRRORS



G. EMPIRE COLLECTION MIRRORS



508 CONTROLS

Mirrors

A. CUSTOM MIRRORS

Fits '82-later models (except VRSCF, XG750A, '14-'16 FLHR, FLHRC and FLHRSE, '14-later FLHTKSE, '18-later FLTRXSE and Revolution® Max models). Street Glide® models require separate purchase of Fairing Plug Kit P/N 57300063. Does not fit XL1200X with mirrors mounted below the handlebar.

1. DOMINION™ COLLECTION MIRRORS*

56000136	Gloss Black.	\$237.95
56000137	Bronze.	\$237.95

2. RIZOMA COLLECTION MIRRORS*

56000263	Black.	\$317.95
-----------------	--------	-----------------

3. EDGE CUT DOME MIRRORS*

56000090		\$255.95
-----------------	--	-----------------

4. PROFILE CUSTOM MIRRORS WITH SLOTTED STEM*

91697-06A		\$151.95
------------------	--	-----------------

5. EDGE CUT STEM MIRRORS*

92441-10		\$237.95
-----------------	--	-----------------

6. BUCKSHOT MIRRORS*

92416-08		\$237.95
-----------------	--	-----------------

7. PROFILE CUSTOM MIRRORS – SATIN BLACK*

56000135	Satin Black with Solid Stem.	\$151.95
-----------------	------------------------------	-----------------

8. DOME MIRRORS – SATIN BLACK*

92423-08A		\$215.95
------------------	--	-----------------

9. WILLIE G SKULL TEARDROP MIRRORS*

56000171	Black.	\$130.95
91315-04	Chrome.	\$130.95

B. TEARDROP MIRRORS*

1. 91971-98	Classic.	\$123.95
2. 91968-98	Harley-Davidson Script.	\$123.95

C. SPLIT VISION MIRRORS*

See even more of the world you just passed. This exclusive design Split Vision Mirror minimizes blind spots and provides a wide panoramic rear view of the left and right lane and the road behind you. The mirror features a large primary panel for normal view and a second outboard convex panel for a wider field of vision. Chrome-plated to a brilliant shine, the mirror's shape adds a contemporary touch to the traditional teardrop design. The deep embossed Harley-Davidson script and the curving slotted stem set this mirror apart from the others.

Fits '82-later models (except VRSCF, XG750A, '14-'16 FLHR, FLHRC and FLHRSE, '14-later FLHTKSE, '18-later FLTRXSE and Revolution Max models). Street Glide models require separate purchase of Fairing Plug Kit P/N 57300063. Does not fit XL1200X with mirrors mounted below the handlebar.

92190-06		\$146.95
-----------------	--	-----------------



A. CUSTOM MIRRORS

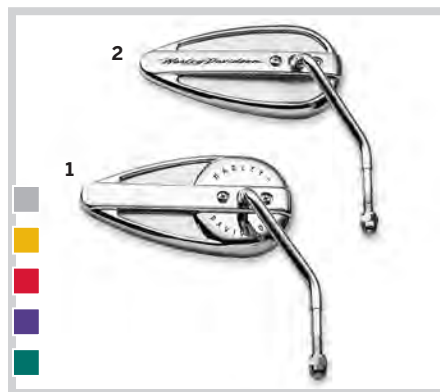

B. TEARDROP MIRRORS



C. SPLIT VISION MIRRORS

*Harley-Davidson Motor Company cannot test and make specific fitment recommendations concerning every possible mirror and handlebar combination. Therefore, after installing new mirrors or handlebars and before operating the motorcycle, check to ensure that the mirrors provide the operator a clear view to the rear.

Model Family Fitment:

V-ROD	SPORTSTER	DYNA
SOFTAIL	TOURING	

Notice: The prices appearing in this catalog are the manufacturer's suggested retail prices. Actual retail prices may vary.

CONTROLS 509

Mirrors

D. ONE-PIECE ROUND MIRRORS*

Fits '82-later models (except VRSCF, XG750A, '14-'16 FLHR, FLHRC and FLHRSE, '11-'13 FLHTCUSE, '14-later FLHTKSE and '18-later FLTRXSE). Does not fit XL1200X with mirrors mounted below the handlebar and RA1250, RA1250S and RH1250S models.

91931-92T	Short Stem, Left Side.	\$39.95
91930-92T	Short Stem, Right Side.	\$39.95

E. LIVE TO RIDE LOGO COLLECTION MIRRORS*

Fits '82-later models (except VRSCF, XG750A, '14-'16 FLHR, FLHRC and FLHRSE, '11-'13 FLHTCUSE, '14-later FLHTKSE and '18-later FLTRXSE). Does not fit XL1200X with mirrors mounted below the handlebar and RA1250, RA1250S and RH1250S models.

1. One-Piece Short Stem Mirrors

91866-90T	Gold, Left.	\$54.95
91864-90T	Gold, Right.	\$54.95

F. TAPERED MIRRORS*

Update your Harley® motorcycle with the latest style in mirrors. This 2003-later Original Equipment-style tapered mirror provides improved rearward visibility, offers a wider range of adjustment and eliminates the rear fasteners for a cleaner look. Available in your choice of satin black or chrome finish.

Fits '82-later models (except VRSCF, XG750A, '14-'16 FLHR, FLHRC and FLHRSE, '14-later FLHTKSE, '18-later FLTRXSE and Revolution® Max models). Street Glide® models require separate purchase of Fairing Plug Kit P/N 57300063. Does not fit XL1200X with mirrors mounted below the handlebar and Revolution Max models.

92023-03A	Black – Short Stem Kit.	\$84.95
91982-03B	Black – Short Stem, Right.	\$43.95
91983-03B	Black – Short Stem, Left.	\$43.95
91909-03B	Black – Long Stem, Right.	\$43.95
91910-03B	Black – Long Stem, Left.	\$43.95
92022-03A	Chrome – Short Stem Kit.	\$84.95
91840-03B	Chrome – Short Stem, Right.	\$43.95
91845-03B	Chrome – Short Stem, Left.	\$43.95
91846-03B	Chrome – Long Stem, Right.	\$43.95
91848-03B	Chrome – Long Stem, Left.	\$43.95

G. MIRROR EXTENSION KIT*

See what's behind you. The Mirror Extension Kit improves visibility to the rear of your bike by repositioning mirrors outward approximately 2.0" and upward 1.0", clearing your field of view and allowing you to see past your shoulders. Available in your choice of chrome or satin black finish to match your mirrors and hand controls. Easy-to-install extenders fit a wide selection of Harley-Davidson® Original Equipment and accessory mirrors.

Fits '06-'17 Dyna® and '08-'14 Softail® models.

56000039	Chrome.	\$65.95
56000042	Satin Black.	\$65.95

H. MIRROR EXTENSION KIT*

Chrome-plated extenders relocate mirrors approximately 2" higher.

91907-87 \$33.95

Fits all models (except VRSCF models, Revolution Max models, XG750A models, and XL1200X models with mirrors mounted below the handlebars).



D. ONE-PIECE ROUND MIRRORS



E. LIVE TO RIDE LOGO COLLECTION MIRRORS – GOLD



F. TAPERED MIRRORS – BLACK



F. TAPERED MIRRORS – CHROME



G. MIRROR EXTENSION KIT – CHROME



G. MIRROR EXTENSION KIT – SATIN BLACK



H. MIRROR EXTENSION KIT

*Harley-Davidson Motor Company cannot test and make specific fitment recommendations concerning every possible mirror and handlebar combination. Therefore, after installing new mirrors or handlebars and before operating the motorcycle, check to ensure that the mirrors provide the operator a clear view to the rear.

Notice: The prices appearing in this catalog are the manufacturer's suggested retail prices. Actual retail prices may vary.

510 CONTROLS

Hand Levers

A. HAND CONTROL LEVER KIT

Continue the custom theme with accessory Hand Control Levers. Cast from aluminum, these levers feature a custom finish designed to match accessory chrome hand controls or complement Original Equipment-style black components. Clutch anti-rattle clip and new pivot bushing included.

Fits '14-'22 XL models.

36700052 Black. **\$128.95**

Fits '96-'03 XL, '96-'17 Dyna® (except '16-'17 FXDLS), '96-'14 Softail® and '96-'07 Touring models. Does not fit Police or models equipped with hydraulic clutch.

45075-07 Chrome. **\$133.95**

44994-07 Black. **\$128.95**

55798-10A Edge Cut. **\$154.95**

Fits '04-'13 XL and XR models.

46944-07A Black. **\$128.95**

Fits '06-'17 VRSC™ models.

42275-07A Black. **\$128.95**

Fits '15-'17 Softail models (except FLSS, FLSTFBS and FXSE).

36700104 Chrome. **\$154.95**

36700105 Black. **\$154.95**

Fits '18-later Softail models. Will slightly extend the brake lever reach of FXFB, FXFBS, FXDRS and FXLRST models.

36700209 Chrome. **\$159.95**

36700210 Black. **\$154.95**

36700211 Edge Cut. **\$175.95**

Fits '21-later Touring models.

36700272 Chrome. **\$151.95**

36700271 Black. **\$151.95**

36700273 Edge Cut. **\$175.95**

36700274 Slotted Chrome. **\$175.95**

Fits '17-'20 Touring and '19-'20 Trike models.

41700422A Chrome. **\$159.95**

41700421A Black. **\$154.95**

41700424A Edge Cut. **\$175.95**

41700425A Slotted Chrome. **\$180.95**

Fits '14-'16 Touring models equipped with hydraulic clutch. Does not fit Trike models.

36700065 Chrome. **\$159.95**

36700064 Black. **\$154.95**

36700067 Edge Cut. **\$175.95**

Fits '14-'16 FLHR and FLHRC and '08-'13 Touring and Trike models. Does not fit models equipped with hydraulic clutch.

38843-08 Chrome. **\$154.95**

38845-08 Black. **\$154.95**

36700004 Edge Cut. **\$154.95**

Fits '17-'18 Trike models.

41700423A Chrome. **\$154.95**



A. CHROME HAND CONTROL LEVERS



A. BLACK HAND CONTROL LEVERS



A. EDGE CUT HAND CONTROL LEVERS



A. SLOTTED HAND CONTROL LEVER KIT



B. CHROME CLUTCH BRACKET AND MASTER CYLINDER KIT - (45355-08A SHOWN)



B. CHROME CLUTCH AND BRAKE MASTER CYLINDER KIT - (41700480 SHOWN)



B. CHROME CLUTCH AND BRAKE MASTER CYLINDER KIT - (4701018 SHOWN)



B. CHROME CLUTCH AND BRAKE MASTER CYLINDER KIT - (41700440 SHOWN)



B. CHROME CLUTCH BRACKET AND MASTER CYLINDER KIT - (42117-08A SHOWN)



B. CHROME CLUTCH AND BRAKE MASTER CYLINDER KIT - (41700263D SHOWN)



B. CHROME CLUTCH AND BRAKE MASTER CYLINDER KIT - (4701019 SHOWN)



B. CHROME CLUTCH AND BRAKE MASTER CYLINDER KIT - (41700463 SHOWN)

CONTROLS 511

Hand Controls

B. CHROME CLUTCH BRACKET AND MASTER CYLINDER RESERVOIR KIT

Replace your stock painted aluminum controls with brilliant chrome, without compromising quality. This kit is manufactured from Original Equipment components and includes a Chrome Master Cylinder Cover. When combined with Chrome Switch Housing Kit, Chrome Switch Caps and other Harley-Davidson® Genuine Motor Accessories, this front brake control kit provides a look that does more than stop your bike – it can stop traffic.

45284-99E **\$388.95**

Fits '96-'03 XL, '96-'05 Dyna® and Softail® models with single disc front brakes and cable-operated clutch.

45281-99E **\$382.95**

Fits '96-'03 XL models, '96-'05 Dyna and Softail and '96-'04 Touring models with dual disc front brakes and cable operated clutch.

45355-08A **\$393.95**

Fits '08-'17 Dyna (except FXDF, FXDLS and '14-'17 FXDL) and '08-'14 Softail models equipped with single disc front brakes and cable-operated clutch.

41700480 **\$425.95**

Fits '18-later Softail (except FXLRS, FXLRST, FXDRS, FXFB and FXFBS) models.

36700100 **\$452.95**

Fits '15-'17 Softail models with cable-operated clutch.

45355-06B **\$388.95**

Fits '06-'07 Dyna and Softail models equipped with single disc front brakes and cable-operated clutch.

41701018 **\$425.95**

Fits '21-later Touring and Trike models (except Road Glide® models) with cable-operated clutch.

41700440 **\$690.95**

Fits '17-'20 Touring (except Road Glide® models) and '19-'20 Trike models.

41700263D **\$690.95**

Fit '14-'16 Touring models (except Road Glide) with hydraulic clutch. Does not fit Trike models.

42117-08A **\$425.95**

Fits '08-'16 Touring models with cable-operated clutch.

46418-05B **\$382.95**

Fits '05-'07 Touring models with cable-operated clutch.

41700441A **\$690.95**

Fits '17-'18 Trike models.

41700330A **\$690.95**

Fits '14-'16 Trike models with hydraulic clutch.

41700463 **\$690.95**

Fits '17-'20 Road Glide® models.

41701019 **\$690.95**

Fits '21-later Road Glide® models with cable-operated clutch.

Model Family Fitment:

V-ROD
 SPORTSTER
 DYNA
 SOFTAIL
 TOURING

Notice: The prices appearing in this catalog are the manufacturer's suggested retail prices. Actual retail prices may vary.

Notice: The prices appearing in this catalog are the manufacturer's suggested retail prices. Actual retail prices may vary.

CONTROLS

512 CONTROLS

Hand Controls

A. SWITCH HOUSING KIT – CHROME

Convert your handlebar switch housings from black to brilliant chrome. Complete kit includes left and right housings sets. No switches or wiring required.

70222-96B **\$151.95**
Fits '02-'17 VRSC™, '96-'13 XL, '08-'12 XR, '96-'11 Dyna®, and Softail® (except FXSTDSE) and '96-'13 Road King® (except FLHRSE) models.

71826-11 **\$108.95**
Fits '14-'22 XL, '12-'17 Dyna® and '11-later Softail® models not equipped with Cruise Control.

71500442 **\$108.95**
Fits '16-later Softail models equipped with cruise control.

71500185 **\$161.95**
Fits '14-later Touring (except FLHRXS) and Trike models.

70228-96C **\$161.95**
Fits '96-'13 FLHTCU, FLHTK, FLTR and FLTRU, '02-'13 FLHRC and '09-'13 FLHTCUTG models. Also fits '02-'13 FLHR models equipped with cruise control.

71813-09 **\$161.95**
Fits '96-'13 FLHT, FLHTC, FLHX and FLTRX and '10-'11 FLHXXX models equipped with cruise control.

B. HANDLEBAR RESERVOIR COVER SET

This kit includes a chrome-plated clutch bracket, handlebar control clamps, master cylinder cover and hardware to completely finish chroming the hand controls. Combine with chrome-plated Switch Housing Kit P/N 70222-96B to finish the look. Cannot be used with Auxiliary Lighting Kits.

46099-98 **\$86.95**
Fits '96-'03 XL, '96-'17 Dyna, '96-'14 Softail and '96-'07 Touring models with dual disc front brakes. (Does not fit VRSC models or models equipped with hydraulic clutch.)

46098-98 **\$86.95**
Fits '96-'03 XL, '96-'17 Dyna and '96-'14 Softail models with single disc front brakes. (Does not fit models equipped with hydraulic clutch.)



A. SWITCH HOUSING KIT – CHROME (71500185 SHOWN)



A. SWITCH HOUSING KIT – CHROME (71500442 SHOWN)



A. SWITCH HOUSING KIT – CHROME (70222-96B SHOWN)



A. SWITCH HOUSING KIT – CHROME



B. HANDLEBAR RESERVOIR COVER SET



Model Family Fitment:
 ■ V-ROD ■ SPORTSTER ■ DYNA
 ■ SOFTAIL ■ TOURING

Notice: The prices appearing in this catalog are the manufacturer's suggested retail prices. Actual retail prices may vary.

CONTROLS 513

Hand Controls

C. TURN SIGNAL EXTENSION CAPS

Make signaling simple. These Turn Signal Extension Caps allow riders to easily reach and activate turn signals without repositioning or removing their hands from the grips. The one-piece design features a contoured thumb extension that places the left- and right-hand signal control in a comfortable position. Available in chrome and black, these Extension Caps replace the stock turn signal switch caps without re-wiring.

Fits '14-'22 XL, '12-'17 Dyna® and '11-later Softail® models (except FLDE, FLHC, FLHCS, FLSB, FLTSE, FXLRST and FXSBSE).

71500177 Black. **\$28.95**
71500178 Chrome. **\$28.95**

Fits '02-'17 VRSC™, '96-'13 XL, '08-'12 XR, '96-'11 Dyna, '96-'10 Softail and '96-'13 Touring and Trike models.

71500179 Black. **\$28.95**

Fits '20-later FLHT, '14-later Road King® and Freewheeler® models. Does not fit CVO™ models or Lighted Hand Control Switches P/N 71500561.

71500285 Black. **\$28.95**

Fits '16-later Electra Glide® (except FLHT), Street Glide®, Ultra Limited™, Road Glide® and FLHTCUTG models. Does not fit CVO™ models or Lighted Hand Control Switches P/N 71500561.

71500286 Black. **\$28.95**

D. SWITCH CAP KIT – CHROME

Not satisfied until everything you see is chrome? These Chrome Switch Cap Kits will add style to one of the most visible areas of your bike, the switches. Shaped for the same ergonomic feel as the Original Equipment hand control switches, these caps replace the stock black caps without re-wiring. The chrome switch caps complement other chrome hand control accessories (Chrome Master Cylinder Kit, Chrome Hand Levers, Chrome Switch Housings and Chrome Master Cylinder Cover) to complete the custom look.

71500187C **\$70.95**

Fits '20-later FLTRK, '19-later FLHTK and FLHTKL, '16-later FLHTCU, FLHTCUL, FLHX, FLHXS, FLHXST, FLTRU, FLTRX, FLTRXS, FLTRXST and '09-'18 FLHTCUTG models. Does not fit CVO models.

71500186A **\$59.95**

Fits '16-later Road King®, '20-later FLHT, and '15-'18 Freewheeler models. Does not fit CVO models.

71500228C **\$70.95**

Fits '16-'18 FLHTK and FLHTKL models. Does not fit CVO models.

71500515 **\$65.95**

Fits '19-later FLHTCUTG and FLTRT models. Does not fit CVO models or Lighted Hand Control Switches P/N 71500561.

71500517 **\$54.95**

Fits 19-later FLRT models. Does not fit with Lighted Hand Control Switches P/N 71500561.

71500441 **\$39.95**

Fits '14-'22 XL, '12-'17 Dyna® and '11-later Softail® models (except FLDE). Kit includes switch cap for cruise-control equipped models for '16-later models. Does not fit models with Auxiliary Lamps.

71804-03 **\$28.95**

Fits '02-'17 VRSC and '96-'13 XL and XR, '96-'11 Dyna, '96-'13 FLHR and '98-'01 FLHRC models. FLHR models equipped with cruise control use Kit P/N 71808-03.

71500110 **\$30.95**

Fits '14-'22 XL, '12-'17 Dyna (except '16-'17 FXDLS), and '11-'15 Softail models.

71802-03 **\$36.95**

Fits '96-'13 FLHTCU, FLHTK, FLTR and FLTRU and '09-'13 FLHTCUTG models.

71816-09 **\$36.95**

Fits '96-'13 FLHT, FLHTC, FLHX and FLTRX and '10-'11 FLHXXX models equipped with cruise control.



C. TURN SIGNAL EXTENSION CAPS – BLACK (71500179 SHOWN)



C. TURN SIGNAL EXTENSION CAPS – CHROME



D. SWITCH CAP KIT – CHROME (71500187C SHOWN)

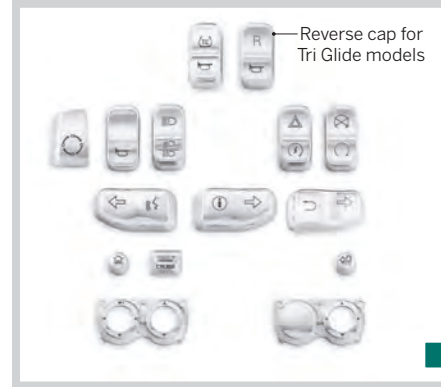

D. SWITCH CAP KIT – CHROME (71500515 SHOWN)



D. SWITCH CAP KIT – CHROME (71500186A SHOWN)



D. SWITCH CAP KIT – CHROME (71500228C SHOWN)



D. SWITCH CAP KIT – CHROME (71500441 SHOWN)

Notice: The prices appearing in this catalog are the manufacturer's suggested retail prices. Actual retail prices may vary.

514 CONTROLS

Hand Controls

A. FRONT MASTER CYLINDER COVER — CHROME

Includes chrome-plated cover, gasket and decal. Easily installed with included stainless steel screws.

45078-96D Brake. **\$53.95**
Fits '02-'05 VRSC™, '96-'03 XL, '96-'05 Dyna® and Softail® and '96-'04 Touring models.

46424-05B Brake. **\$53.95**
Fits '06-'17 Dyna, '06-'14 Softail and '05-'07 Touring models. Also fits '14-later Trike brake master cylinder and '14-'16 Trike clutch master cylinders.

42123-08 Brake. **\$64.95**
Fits '08-later Touring and '09-'13 and '19-later Trike models.

36700094A Clutch. **\$64.95**
Fits '14-'16 Touring models equipped with hydraulic clutch. Does not fit Trike models.

41700297 Brake. **\$54.95**
Fits '15-'17 Softail models.

41700442 Clutch. **\$69.95**
Fits '17-'20 Touring and '19-'20 Trike models.

B. EDGE CUT MASTER CYLINDER COVER

The Edge Cut master cylinder cover features a crisp anodized finish that is machined to expose the highlights or raw aluminum. The contrasting cut back look makes a powerful visual statement, and works great with both traditional and contemporary customizing styles. This cover is a direct replacement for the Original Equipment master cylinder cover. Easily installed kit includes cover, gasket and black hardware.

41700334 Brake. **\$74.95**
Fits '06-'17 VRSC, '08-later Touring and '09-'13 Trike models.



A. CHROME MASTER CYLINDER COVER 45078-96D



A. CHROME MASTER CYLINDER COVER 46424-05B



C. REAR MASTER CYLINDER COVER — CHROME (46463-08 SHOWN)



C. REAR MASTER CYLINDER COVER — CHROME



A. CHROME MASTER CYLINDER COVER 42123-08



A. CHROME MASTER CYLINDER COVER 36700094A



D. BANJO BOLT KIT — CHROME



B. EDGE CUT MASTER CYLINDER COVER

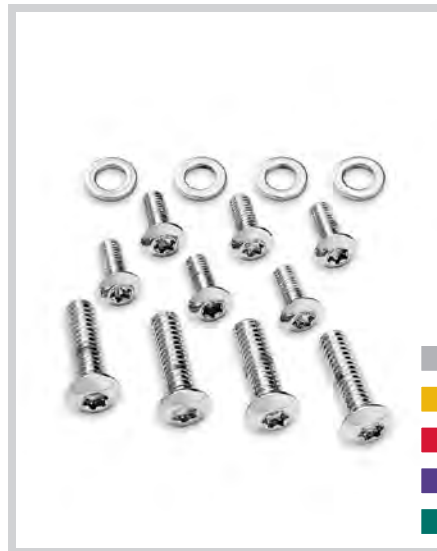

E. SWITCH HOUSING HARDWARE KIT



F. REDUCED EFFORT CLUTCH KIT

CONTROLS 515

Hand Controls

C. REAR MASTER CYLINDER COVER — CHROME

An easy way to add chrome to your bike is with this chrome-plated version of the stock master cylinder cover.

46463-08 **\$64.95**
Fits '08-later Touring models. Does not fit Trike models.

46425-05A **\$53.95**
Fits '06-'17 Dyna® non-ABS models, '06-'17 Softail® and '05-'07 Touring models.

45149-99C **\$53.95**
Fit '00-'05 Softail and '99-'04 Touring models.

D. BANJO BOLT KIT — CHROME

Replace the Original Equipment zinc finish brake line hardware with brilliant chrome custom banjo bolts.

41843-08 **\$54.95**
Fits '06-'17 VRSC™, '08-later Touring and '09-'13 Trike models.

E. SWITCH HOUSING HARDWARE KIT

Complete the chrome conversion with this Chrome Hardware Kit. Chrome-plated stainless steel hardware replaces the Original Equipment black hardware on the hand control switch housing, clutch and brake bracket clamps.

91124-03A **\$27.95**
Fits '96-later models (except 15-later XG, '04-'22 XL and XR and '15-later Softail, Touring and Trike).

F. REDUCED EFFORT CLUTCH KIT

Kit includes a new clutch spring and inner/outer ramps that significantly reduce clutch lever effort. Original Equipment on '06-later Twin Cam-equipped models.

36808-05 **\$55.95**
Fits '99-'05 Twin Cam-equipped models. Stock on '06-later Twin Cam-equipped models. This kit is not for use with Screamin' Eagle® Performance Parts.

CONTROLS

Model Family Fitment:

- V-ROD
- SPORTSTER
- DYNA
- SOFTAIL
- TOURING

Notice: The prices appearing in this catalog are the manufacturer's suggested retail prices. Actual retail prices may vary.

Notice: The prices appearing in this catalog are the manufacturer's suggested retail prices. Actual retail prices may vary.

516 CONTROLS

Hand Controls

A. LIGHTED HAND CONTROL SWITCHES

Add function and style to the Original Equipment hand controls. Lighted Hand Controls feature soft white LED backlighting that illuminates the switch function icons for enhanced night-time visibility. You get at-a-glance identification and a modern up-to-date look. Kit includes plug-in switch packs for left- and right-hand controls, now including the Traction Control switch for '20-later models.

71500629 **\$286.95**
Fits '21-later Touring models with Traction Control and '21-later FLHTCUTG. Does not fit Road King® or FLHT models. Does not fit with Chrome Switch Cap Kits.

71500561 **\$286.95**
Fits '20 Touring models with Traction Control and '19-'20 FLHTCUTG. Does not fit with Chrome Switch Cap Kits.

71500248C **\$266.95**
Fits '14-'20 Touring models (without Traction Control) with a Boom!™ Box audio system (for RDRS see P/N 71500561) and '14-'18 FLHTCUTG models. Stock on '14-'19 CVO™ Touring models.

71500250B **\$266.95**
Fits '14-'16 FLHR and FLHRC models.

B. CLUTCH FERRULE AND BANJO BOLT COVER KITS

These chrome-plated die-cast covers provide a custom look to your hand controls. The pair of tapered covers conceals the brake banjo bolt cable and the clutch cable or hydraulic line connections as they enter the hand controls. The two-piece design is easy to install and adds a finishing touch to Original Equipment or braided lines and cables. Kits are available for models with cable- or hydraulic-operated clutch.

41300061 Brake and Cable Clutch. **\$38.95**
Fits '84-later models (except VRSC™, '15-later XG, and '08-later XR). Will not fit models equipped with hydraulic clutch. Some models may require rotation of the front master cylinder banjo fitting. See the service manual for Brake systems procedures.

41300062 Brake and Hydraulic Clutch. **\$38.95**
Fits '09-'17 VRSC™, '14-'20 Touring (except Road Glide®), '14-'20 Trike and '08-'20 CVO models and bikes equipped with hydraulic clutch. Does not fit '15-later Softail® models. Some models may require rotation of the front master cylinder banjo fitting. See the service manual for Brake systems procedures.

C. CLUTCH FERRULE AND BANJO BOLT COVER KIT – CHROME

Die-cast chrome covers provide a custom look to your stock banjo bolts and handlebar clutch ferrule. Fits clutch ferrule on handlebar and banjo bolts on brake master cylinders and calipers. Installs in seconds.

32714-98A **\$38.95**
Fits '84-later models with stock master cylinder and calipers (except '02-later VRSC, '15-later XG, '04-'22 XL, '18-later Softail and '08-later Touring and Trike). Will not fit models equipped with hydraulic clutch.



A. LIGHTED HAND CONTROL SWITCHES



A. LIGHTED HAND CONTROL SWITCHES – (71500561 SHOWN)



A. LIGHTED HAND CONTROL SWITCHES – (71500248C SHOWN)



B. CLUTCH FERRULE AND BANJO BOLT COVER KITS



B. BRAKE & CABLE CLUTCH



B. BRAKE & HYDRAULIC CLUTCH



C. CLUTCH FERRULE AND BANJO BOLT COVER KIT – CHROME



D. CRUISE CONTROL KIT (41000369 SHOWN)



E. HANDLEBAR SWITCH CONTROL KIT



F. AUXILIARY ACCESSORY SWITCH HOUSING KIT – CHROME (SHOWN WITH AUXILIARY ON/OFF SWITCH)



F. AUXILIARY ACCESSORY SWITCH HOUSING KIT – BLACK (SHOWN WITH AUXILIARY ON/OFF SWITCH)



G. AUXILIARY ON/OFF SWITCH KIT

CONTROLS 517

Hand Controls

D. CRUISE CONTROL KIT

For long-distance runs, there's nothing better than letting your bike do all the work. This Cruise Control Kit puts you just minutes away from true touring bliss. Unlike mechanical throttle controls or friction thumb wheels, this complete electronic speed control allows you to set and maintain constant speed at the touch of a button. Your dealer will install the new hand controls, enable the cruise control function in the Electronic Control Module (ECM) and you're ready to roll. No splicing into the wiring harness to install. Kit includes updated switch housings and all necessary hardware.

41000369 **\$266.95**
Fits '16-later Softail® models. Original Equipment on '16-'17 FLSS, FLSTC, FLSTFBS, FLSTN and FXSE models and '18-later FLHC, FLHCS and FLSB models. Dealer Digital Technician™ software update is required.

E. HANDLEBAR SWITCH CONTROL KIT

Updated for use with '07-later models equipped with clutch interlock system. This exclusive Harley-Davidson® kit simplifies the switch to custom style handlebars. Kit features the Original Equipment left and right switch housings, 60.0" wiring harness and all necessary hardware.

70239-07 **\$175.95**
Fits '96-'13 XL, '08-'13 XR, '96-'11 Dyna® and '96-'10 Softail models (except '07-'10 FLSTF). Also fits '96-'13 Touring models without cruise control or radio controls.

F. AUXILIARY ACCESSORY SWITCH HOUSING KIT

Keep your eyes on the road and your hands on the grips with these easy-to-reach Auxiliary Accessory Switch Housings. Available for left and right hand control clusters, these housings will allow you to install up to six switches (when two housings are used) to control various electrical devices. Available in black to match Original Equipment switch housings or a bright chrome finish to complement accessory Chrome Switch Housing Kits. All necessary mounting hardware is included. Switches sold separately.

Fits '96-later VRSC™, XL, XR, Dyna, Softail (except FLSB, FLSTF, FLSTFBS, FLSTFBS, FXDRS, FXSB and FXSE) and Touring models (except '15-later Road Glide® and FLHRXS). Does not fit Trike models. Does not fit models equipped with Large Diameter Handlebars, Handlebar-Mounted GPS, Boom!™ Audio Cruiser Amp & Speaker Kits or Tour-Pak® Mounted CD Changer P/N 77184-01. '04-'22 XL and XR models require separate purchase of (2) Screw P/N 3832M.

70213-02C Chrome Left Side. **\$43.95**
70248-02B Black Left Side. **\$43.95**

Fits '96-later VRSC, XL, XR, Dyna, Softail (except FLSB, FLSTF, FLSTFBS, FLSTFBS, FXDRS and FXSE) and Touring models (except '15-later Road Glide and FLHRXS). Does not fit Trike models. Does not fit models equipped with Large Diameter Handlebars, Handlebar-Mounted GPS, Boom! Audio Cruiser Amp & Speaker Kits or Tour-Pak Mounted CD Changer P/N 77184-01. '04-'22 XL and XR models require separate purchase of (2) Screw P/N 3832M.

70255-02B Chrome Right Side. **\$43.95**

G. AUXILIARY ON/OFF SWITCH KIT

Styled to match the Original Equipment hand controls. These Auxiliary On/Off switches allow you to control additional electrical accessories with the touch of a finger when installed in the Auxiliary Accessory Switch Housing. Switches sold individually.

71718-02 **\$23.95**
Fits Auxiliary Accessory Switch Housing Kits P/N 70255-02B, 70256-02, 70213-02C and 70248-02B.

Model Family Fitment:

- V-ROD
- SPORTSTER
- DYNA
- SOFTAIL
- TOURING

Notice: The prices appearing in this catalog are the manufacturer's suggested retail prices. Actual retail prices may vary.

Notice: The prices appearing in this catalog are the manufacturer's suggested retail prices. Actual retail prices may vary.

COMFORT, STYLE OR BOTH?

Every person is unique. Your overall height, arm reach, upper body length and riding style all dictate your relationship to the bike's controls. Add in the desire for a unique, custom look and your handlebar options multiply exponentially.*



REACH™ HANDLEBARS

Recommended for shorter riders, Reach™ Handlebars are shaped to position the hand controls closer to the rider for optimized elbow and wrist position.



TALLBOY™ HANDLEBARS

Recommended for taller riders, Tallboy™ handlebars enable long-armed riders to more comfortably fit and maneuver the motorcycle.

YOUR RIDING POSITION

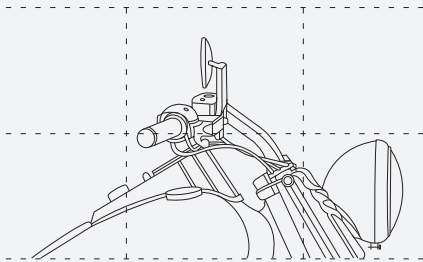

DRAG HANDLEBAR*

Narrow, flat and more aggressive, drag bars provide a straight elbow and neutral hand and wrist position. For maximum comfort, drag bars can be positioned with curved or straight risers to minimize stretch to the controls.

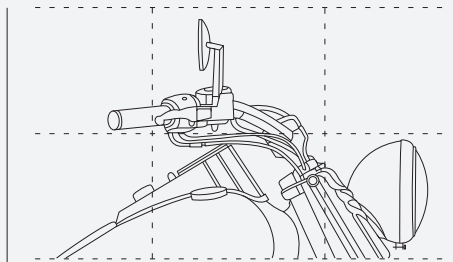

BEACH HANDLEBAR*

Low and wide, a beach bar spreads your arms and gives you room to breathe. Ideal for the rider with long arms, beach bars can be a little too wide for many riders. While selecting a bar, make sure you can reach the hand controls when the handlebar is fully turned.

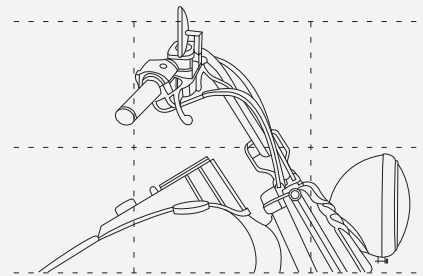

APE & TALLBOY HANDLEBAR*

Tall and wide, ape and Tallboy™ handlebars provide a classic "fists-in-the-wind" look and can add long-haul comfort for riders with long arms. Because handlebar height is regulated in many areas, check local laws before installing a tall handlebar.

CHIZELED HANDLEBAR*

For cutting edge style, a Chizeled Bar combines the hands-up feel of a mini-ape with the narrow width of a drag bar. The bar's shoulder-width design keeps the elbows in and the arms straight ahead, and the wrist and hands fall in a neutral palms-down grip.

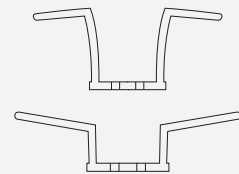

HANDLEBAR DIMENSIONS

(IN INCHES)

Handlebar Kit	Bar Diameter	Width	Pull Back	Rise	Base Width	Knurl Center	Handlebar Kit	Bar Diameter	Width	Pull Back	Rise	Base Width	Knurl Center
55800103	1.00	25.75	4.30	8.30	8.50	3.22	55801006	1.25	39.00	5.10	13.30	14.20	3.40
55800188	1.25	32.00	7.00	8.00	10.00	3.22	55801007	1.25	39.00	5.10	13.30	14.20	3.40
55800198	1.00	25.75	4.30	8.30	8.50	3.22	55801015	1.00	31.70	4.60	12.90	11.00	2.94
55800345	1.00	28.50	4.75	3.75	7.50	3.14	55801016	1.00	31.70	4.60	12.90	11.00	2.94
55800421	1.25	27.50	4.00	12.00	9.50	3.00	55801029	1.25	32.70	4.60	13.20	12.10	2.94
55800430	1.00	27.50	5.50	4.00	8.50	3.14	55801030	1.25	32.70	4.60	13.20	12.10	2.94
55800431	1.00	27.50	5.50	4.00	8.50	3.14	55801057	1.00	28.30	5.60	9.80	11.00	2.94
55800439	1.25	31.00	6.25	14.00	11.25	3.00	55801058	1.25	29.30	5.60	10.10	12.10	2.94
55800440	1.25	31.00	6.25	14.00	11.25	3.00	55801059	1.25	29.30	5.60	10.10	12.10	2.94
55800563	1.00	30.00	9.25	5.25	11.75	3.14	55801060	1.00	33.80	5.80	8.60	17.40	3.40
55800568	1.25	32.00	4.75	9.00	11.25	3.00	55801061	1.00	33.80	5.80	8.60	17.40	3.40
55800569	1.25	32.00	4.75	9.00	11.25	3.00	55801062	1.25	35.00	6.50	10.10	14.20	2.94
55800579	1.00	31.75	6.25	7.00	9.00	3.50	55801063	1.25	35.00	6.50	10.10	14.20	2.94
55800587	1.00	31.00	4.50	7.25	10.00	3.14	55801263	1.0	33.8	2.79	8.0	4.65	3.5
55800589	1.00	30.81	13.09	6.63	15.14	3.48	55801280	1.0	33.8	6.0	3.7	4.65	3.5
55800590	1.00	30.81	13.09	6.63	15.14	3.48	55800035A	1.00	29.25	3.80	0.00	9.00	3.14
55800591	1.00	32.39	6.03	11.17	16.16	3.48	55800548A	1.25	33.75	9.25	14.75	12.50	3.14
55800592	1.00	32.39	6.03	11.17	16.16	3.48	55800549A	1.25	33.75	9.25	14.75	12.50	3.14
55800714	1.25	34.68	7.09	7.68	10.20	3.14	55800550A	1.25	34.75	10.00	12.25	12.50	3.14
55800715	1.00	31.64	6.85	7.00	9.84	3.14	55800551A	1.25	34.75	10.00	12.25	12.50	3.14
55800717	1.00	31.64	6.85	7.00	9.84	3.14	55914-98	1.00	30.75	7.50	12.25	15.00	3.50
55800719	1.00	34.64	9.34	5.03	13.06	3.14	55954-00	1.00	30.00	9.00	9.50	13.75	3.14
55800721	1.00	34.64	9.34	5.03	13.06	3.14	55967-08	1.25	35.50	11.50	4.75	12.25	3.50
55800856	1.00	28.50	3.00	1.50	5.74	N/A	56036-08	1.00	31.75	6.50	10.00	15.75	3.50
55800858	1.25	28.50	3.00	1.50	5.74	N/A	56166-08	1.00	32.00	5.50	11.25	13.00	3.14
55800861	1.00	28.50	4.00	0.00	7.26	3.50	56180-08	1.00	30.00	9.00	9.50	13.75	3.14
55801003	1.00	32.00	6.50	8.75	10.00	3.14	56902-08	1.00	31.25	5.00	12.00	11.50	3.14
55801004	1.00	38.00	4.60	12.90	17.40	3.40	57474-11	1.00	35.00	1.75	12.00	16.00	3.50
55801005	1.00	38.00	4.60	12.90	17.40	3.40	57485-11	1.00	35.00	1.75	12.00	16.00	3.50

CHOOSING YOUR HANDLEBAR

RISE is the vertical distance between a handlebar's tip and its base. Adding risers to bars that sit too low can help put hand grips into your sweet spot.

PULL BACK is the distance the handlebar tips come back toward the rider. Greater pull back can eliminate the long reach to the bar for a shorter rider.

WIDTH is measured from tip to tip. Make sure the bar isn't too wide so it pulls your hands off the grips when turning.

KNURL CENTER is the distance between the center line of the bar's knurling. The measurement should match the riser dimension to maximize clamping pressure.

*NOTE: Installation of some handlebars and risers may require a change in clutch and/or throttle cable and brake lines for some models. Handlebar height is regulated in many locations. Check local laws to ensure your motorcycle meets applicable regulations.
**1.25" Fat Bar base necks down to fit 1.0" handlebar clamp.

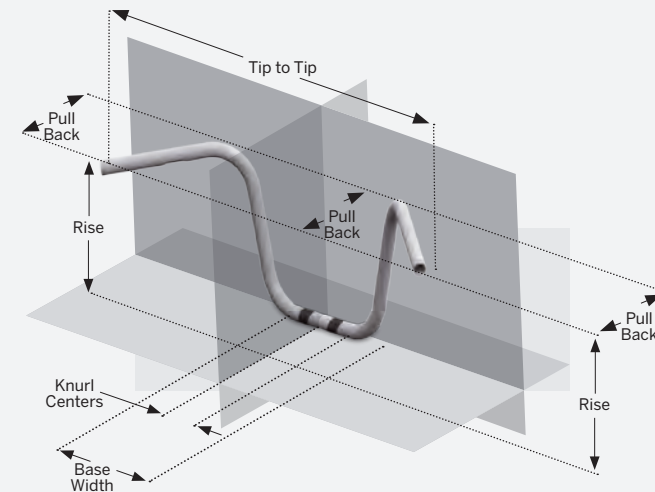

520 CONTROLS

Handlebars – Dyna®/Softail®

A. EXTREME REACH™ HANDLEBAR*

Extensively tested with a panel of riders between 5'-0" to 5'-5" tall, this Extreme Reach™ Handlebar and recommended riser combination was proven to be the most ergonomically pleasing handlebar for many Dyna® and Softail® models. Shaped to provide the ideal balance of pull back and width, this handlebar produces an overall pull back of 11.0" and a tip-to-tip width of 30.0" when combined with Curved Riser Kit P/N 56266-09 (sold separately). Your hands fall naturally in place and the narrow width reduces your stretch while making low-speed turns and parking lot maneuvers.

55800563 **\$74.95**

Fits '06-'17 Dyna (except '14-'17 FXDL) and '00-'17 Softail models (except FLSS, FLSTFB, FXCW, FXCWC, FXS, FXSB, FXSTD and Springer™). Does not fit CVO™ models. All models require separate purchase of additional installation components.

See your Dealer for cables, lines and additional installation components required, or visit www.H-D.com/store and search part number 55800563.



A. EXTREME REACH HANDLEBAR



A. EXTREME REACH HANDLEBAR WITH RISER KIT P/N 56266-09

B. REACH HANDLEBAR* – 1.0"

Recommended for riders between 5'-2" and 5'-8" tall, this Reach Handlebar is shaped to position the hand controls closer to the rider for optimized elbow and wrist position. Designed to provide the ideal balance of pull back and width, this handlebar allows your hands fall naturally in place. The narrower width reduces your stretch while making low-speed turns and parking lot maneuvers, and the overall effect is improved confidence and long-range comfort for short-armed riders.

Fits '18-later FLDE, FLHC, FLHCS, FLSL, FXBB, FXLR, FXST and '21-later FXBBS models. All models require separate purchase of additional installation components.

55800715 Chrome. **\$95.95**
55800717 Black. **\$95.95**

See your Dealer for cables, lines and additional installation components required, or visit www.H-D.com/store and search part number 55800715 or 55800717.



A. EXTREME REACH HANDLEBAR (SHOWN WITH CURVED RISER KIT)



B. REACH HANDLEBAR – 1.0"



C. FAT REACH HANDLEBAR – 1.25"



D. TALLBOY HANDLEBAR – 1.0"

CONTROLS 521

Handlebars – Dyna®/Softail®

C. FAT REACH™ HANDLEBAR* – 1.25"

Slammed and styled for a low-profile look, this 1.25" handlebar places the hand controls closer to the rider for an optimized elbow bend and wrist position, offering improved confidence and long-range comfort for shorter-armed riders.

Fits '18-later FLFB, FLFBS, FLFL, FLFLB, FXBR, FXBRS, FXDRS, FXFB and FXFBS models. Does not fit FXFB and FXFBS models without ABS Brakes. FLFL models require separate purchase of 1.25" handlebar riser kit. All models require separate purchase of additional installation components.

55800714 Gloss Black. **\$297.95**

See your Dealer for cables, lines and additional installation components required, or visit www.H-D.com/store and search part number 55800714.

D. TALLBOY™ HANDLEBAR – 1.0"

Recommended for riders 5'9" and taller, this 1.0" Tallboy™ handlebar enables long-armed riders to more comfortably fit and maneuver Softail® motorcycle. Shaped to provide the ideal balance of rise and width, this bar places the hands in a neutral position and stretches the arms to reduce the bend at the elbow.

Fits '18-later FLDE, FLHC, FLHCS, FLSL, FXBB, FXLR, FXST and '21-later FXBBS models. All models require separate purchase of additional installation components.

55800719 Chrome. **\$95.95**
55800721 Gloss Black. **\$95.95**

See your Dealer for cables, lines and additional installation components required, or visit www.H-D.com/store and search part number 55800719 or 55800721.



Reach Handlebars



Tallboy Handlebars

*NOTE: Installation of some handlebars and risers may require a change in clutch and/or throttle cable and brake lines for some models. Handlebar height is regulated in many locations. Check local laws to ensure your motorcycle meets applicable regulations.

Notice: The prices appearing in this catalog are the manufacturer's suggested retail prices. Actual retail prices may vary.

*NOTE: Installation of some handlebars and risers may require a change in clutch and/or throttle cable and brake lines for some models. Handlebar height is regulated in many locations. Check local laws to ensure your motorcycle meets applicable regulations.

Model Family Fitment:

V-ROD
 SPORTSTER
 DYNA
 SOFTAIL
 TOURING

Notice: The prices appearing in this catalog are the manufacturer's suggested retail prices. Actual retail prices may vary.

522 CONTROLS

Handlebars – Dyna®/Softail®/Sportster®

A. REACH® HANDLEBAR*

With a shape designed to place the handlebars closer to the rider, this Reach® Handlebar puts the rider in an upright seating position for added comfort and control. Designed to place the handlebars closer to the rider for ideal fit, comfort and control. Nightster® models require separate purchase of Brake Line P/N 41800874 Gloss Black finish.

Fits '21-later RH1250S and '22-later RH975 models.

55801263 Gloss Black. **\$99.95**

See your Dealer for cables, lines and additional installation components required, or visit www.H-D.com/store and search part number 55801263.



A. REACH® HANDLEBAR

B. TRACKER HANDLEBAR*

Inspired by rough-and-tumble flat track race bikes, this handlebar is wider and taller than stock and features a cross brace. • Designed to give the Sportster® S and Nightster models additional leverage during spirited riding. Fixed cross-bar gives aggressive look to front end. Nightster models require separate purchase of Brake Line P/N 41800874 Gloss Black finish

Fits '21-later RH1250S and '22-later RH975 models.

55801280 Gloss Black. **\$149.95**

See your Dealer for cables, lines and additional installation components required, or visit www.H-D.com/store and search part number 55801280.



B. TRACKER HANDLEBAR

C. STREET SLAMMER BAR*

Comfort and attitude in one. This Street Slammer drag bar with 7.0" integrated risers offers a stylish alternative to separate curved risers, bar and handlebar clamp combinations and reduces the stretch required to reach traditional straight bars. This 1.25" fat bar is factory drilled to accept hidden control wires for a clean custom look. Available in brilliant chrome or satin black finish.

Fits '12-'16 FLD, '06-'17 FXDB, '08-'17 FXDF, '01-'05 FXDL, '16-'17 FXDLS, '99-'17 FXDWG, '00-'17 FLS, FLSS, FLSTC, FLSTF, FLSTFB, FLSTFBS, FLSTN, FXST, FXSTB, FXSTC and FXSTD, and '03-'13 FLHR and FLHRC models. All models require separate purchase of additional installation components. Does not fit Road King® models equipped with cruise control, '08 ABS-equipped models, Heated Hand Grips, Hydraulic Clutch Kits, Handlebar Mounted Gauges, Road Tech™ Radio, Softail® Nacelle Kit or Sidecar-equipped models.

55801309 Chrome. **\$288.95**

55801308 Satin Black. **\$288.95**

See your Dealer for cables, lines and additional installation components required, or visit www.H-D.com/store and search part number 55801309 or 55801308.



C. STREET SLAMMER BAR – CHROME (ROAD KING SHOWN)

D. DRAG BAR*

Nothing says minimalist like a classically simple drag bar. Shaped to give the Nightster and Iron 883™ models an aggressive riding profile, this satin black 1.0" Drag Bar features 0" of rise and 4.0" of pull back to provide an excellent combination of forward positioning and wrist control.

55800035A Satin Black. **\$95.95**

Fits '07-'22 XL models with 2.2 or 3.3 gallon fuel tank. Does not fit XL883C, XL883R, XL1200C, XL1200L, XL1200R, XL1200T, '11-'22 XL883L or models equipped with 4.5 gallon large-capacity fuel tank. All models require separate purchase of additional components.

Shown with: HANDLEBAR RISER SPACER KIT

Required for installation of Clubman, Drag, Chizeled and Chizeled Lo Handlebars on Sportster XL1200X models.

55900074 **\$60.95**

Fits '10-'22 XL1200X and XL1200XS models.

See your Dealer for cables, lines and additional installation components required, or visit www.H-D.com/store and search part number 55800035A.



D. DRAG BAR – SATIN BLACK (SHOWN ON XL1200X WITH RISER SPACER KIT)

*NOTE: Installation of some handlebars and risers may require a change in clutch and/or throttle cable and brake lines for some models. Handlebar height is regulated in many locations. Check local laws to ensure your motorcycle meets applicable regulations.

Notice: The prices appearing in this catalog are the manufacturer's suggested retail prices. Actual retail prices may vary.

CONTROLS 523

Handlebars – Softail®

D. MOTO BAR – BLACK ANODIZED*

Made from lightweight aluminum anodized with a black finish, this club-style handlebar features a performance-style graphic. Pair with tall risers to complete the unique custom look.

55800856 1" **\$139.95**

Fits '18-later FLSL, FXBB, FXLR, FXLRS (ABS only), and FXST, '14-later Road King® models and '21-later FXBBS models. Does not fit FXBB, FXBBS and FXST models with accessory Quarter Fairing or accessory windshields when using original equipment handlebar risers. FXLR models equipped with Color-Matched Quarter Fairing and Tall Risers P/N 55800852 require separate purchase of Turn Signal Brackets P/N 12700164 and 67800630. Installation requires separate purchase of additional components.

55800858 1.25" Tapered. **\$180.95**

Fits '18-later FLFB, FLFBS, FLSL, FXBB, FXBBS, FXBR, FXBRS, FXDRS, FXFB, FXFBS, FXLR, FXLRS and FXST, '14-later Road King models. Does not fit FLFB, FLFBS, FXBR, or FXBRS models with accessory windshields. Does not fit FXBB, FXBBS and FXST models with accessory Quarter Fairing or accessory windshields when using original equipment handlebar risers. FXLR models equipped with Color-Matched Quarter Fairing and Tall Risers P/N 55800854 require separate purchase of Turn Signal Brackets P/N 12700164 and 67800630. Installation requires separate purchase of additional components.

See your Dealer for cables, lines and additional installation components required, or visit www.H-D.com/store and search part number 55800856 or 55800858.

E. DRAG BAR*

This nearly straight 1" drag bar moves the hands forward and gives riders a new option for a more aggressive, sporty riding position. The dark finish matches other dark components to complete or complement an overall blacked-out style.

55800861 Gloss Black. **\$95.95**

Fits '18-later FXBB, FXLR, FLSL, FXST and '21-later FXBBS models. Does not fit with accessory windshields on stock risers. Installation requires separate purchase of additional components.

See your Dealer for cables, lines and additional installation components required, or visit www.H-D.com/store and search part number 55800861.



D. 1" MOTO BAR – BLACK ANODIZED



D. 1.25" MOTO BAR – BLACK ANODIZED, TAPERED



E. DRAG BAR – GLOSS BLACK

*NOTE: Installation of some handlebars and risers may require a change in clutch and/or throttle cable and brake lines for some models. Handlebar height is regulated in many locations. Check local laws to ensure your motorcycle meets applicable regulations.

Model Family Fitment:

V-ROD
 SPORTSTER
 DYNA
 SOFTAIL
 TOURING

Notice: The prices appearing in this catalog are the manufacturer's suggested retail prices. Actual retail prices may vary.

524 CONTROLS

Handlebars – Sportster®

A. SPORTSTER® TALLBOY™ HANDLEBAR*

Ergonomically designed and tested by a panel of riders from 5'11" to 6'4", this 1.0" Tallboy™ handlebar enables long-armed riders to more comfortably fit and maneuver a compact Sportster® model. Shaped to provide the ideal balance of rise and width, this bar places the hands in a neutral position and stretches the arms to reduce the bend at the elbow.

Fits '07-'22 XL models (except XL883R and XL883C). All models require separate purchase of additional installation components.

55800587 Gloss Black. **\$121.95**

See your Dealer for cables, lines and additional installation components required, or visit www.H-D.com/store and search part number 55800587.

B. IRON 883™ HANDLEBAR*

Add an edgy touch to your Sportster® model. Featuring the same shape, rise and pull back of the Iron 883™ Original Equipment stainless pull back handlebar, this satin black bar provides a choice in customizing style without the need to change cables and brake lines. Original Equipment on XL883N and XL1200X models.

55800345 Satin Black. **\$98.95**
Fits '10-'22 XL883L, XL1200C, XL1200NS, XL1200T, XL1200V and XL1200XS models. Installation requires separate purchase of additional components. Original Equipment on XL883N and XL1200X models.

See your Dealer for cables, lines and additional installation components required, or visit www.H-D.com/store and search part number 55800345.



A. SPORTSTER TALLBOY HANDLEBAR



B. IRON 883 HANDLEBAR – SATIN BLACK

*NOTE: Installation of some handlebars and risers may require a change in clutch and/or throttle cable and brake lines for some models. Handlebar height is regulated in many locations. Check local laws to ensure your motorcycle meets applicable regulations.

Notice: The prices appearing in this catalog are the manufacturer's suggested retail prices. Actual retail prices may vary.



C. HOLLYWOOD HANDLEBAR (SPORTSTER FORTY-EIGHT SHOWN)



D. BEACH HANDLEBAR (HERITAGE SOFTAIL CLASSIC SHOWN)



E. NARROW BEACH HANDLEBAR (FAT BOY SHOWN)

CONTROLS 525

Handlebars – Dyna®/Softail®/Road King®

C. HOLLYWOOD HANDLEBAR*

Original Equipment on the Softail Slim® model, this traditional Hollywood-styled handlebar combines the laid-back riding attitude of the '40s with a shape that's perfect for today's new school stripped-down bobbers. With its limited rise, narrow profile and gentle pull back shape, this bar captures the look of a classic bar without the wide beach bar riding position.

55800579 Gloss Black. **\$121.95**
Fits '10-'22 XL1200X and XL1200XS, '06-'17 FXDB, '10-'17 FXDWG, '00-'17 FLSTC, FLSTF and FLSTFB, '08-'17 FLSTN, '18-later Softail® (except FXFB, FXFBS, FXBR, FXBRS, FXLRS and FXLRST), '15-later FLRT models. Requires separate purchase of additional installation components.

See your Dealer for cables, lines and additional installation components required, or visit www.H-D.com/store and search part number 55800579.

D. BEACH HANDLEBAR*

This beefy 1.25" bar shows off your bike in style! This fat bar allows you to tuck the wires inside the bar for a clean, custom appearance and the highly polished and chrome-plated bar will get you noticed. Installation requires separate purchase of additional components.

55967-08 Chrome. **\$219.95**
Fits '12-'16 FLD, '06-'07 and '13-'17 FXDB, '08-'17 FXDF, '01-'05 FXDL, '99-'17 FXDWG, '00-'15 FXST, FXSTB, FXSTC and FXSTD and '03-'13 FLHR, FLHRC, FLHRS. All models require separate purchase of additional installation components. Does not fit '08 ABS-equipped models, Hydraulic Clutch Kits, Handlebar Mounted Gauges, Road Tech™ Radio, Softail® Freight Train Nacelle Kit, or Sidecar-equipped models. Compatible with accessory heated grips (except FLHTK Heated Grips or Black Rubber Heated Hand Grips P/N 56100034).

See your Dealer for cables, lines and additional installation components required, or visit www.H-D.com/store and search part number 55967-08.

E. NARROW BEACH HANDLEBAR*

This beefy 1.25" handlebar sets the tone for a full-on custom ride. This chrome-plated fat bar combines the low rise and sweeping shape of a beach-style bar with a narrower tip-to-tip width for added rider comfort. Factory drilled to allow internal wiring for show-winning style.

55801330 **\$209.95**
Fits '12-'16 FLD, '13-'17 FXDB and '00-'15 FXST, FXSTB, FXSTC, FXSTD. May require separate purchase of riser kit and additional installation components. Compatible with accessory heated grips (except FLHTK Heated Grips or Black Rubber Heated Hand Grips P/N 56100034).

See your Dealer for cables, lines and additional installation components required, or visit www.H-D.com/store and search part number 55801330.

*NOTE: Installation of some handlebars and risers may require a change in clutch and/or throttle cable and brake lines for some models. Handlebar height is regulated in many locations. Check local laws to ensure your motorcycle meets applicable regulations.

Model Family Fitment:

- V-ROD
- SPORTSTER
- DYNA
- SOFTAIL
- TOURING

Notice: The prices appearing in this catalog are the manufacturer's suggested retail prices. Actual retail prices may vary.

526 CONTROLS

Handlebars – Sportster®/Dyna®

A. CHIZELED HANDLEBAR*

Achieve ultimate cutting-edge style. The Chizeled Bar features the edgy profile of the classic Z bar and combines the hands-up feel of a mini-ape with the narrow width of a drag bar. The result? A classic chopper attitude. The 1.0" bar replaces mitered and welded corners with cast seamless 90° bends for added strength and style. The cast elbows eliminate sharp internal bends and the bar features removable Bar & Shield plugs to simplify internal wiring.

Fits '07-'22 XL883L, XL883N, XL1200L, XL1200N, XL1200NS, XL1200T, XL1200V, XL1200X and XL1200XS models. Also fits '06-'17 FXDB models with Original Equipment Handlebar P/N 58079-93. Does not fit with Heated Hand Grips. XL models require separate purchase of additional components.

55800198	Chrome.	\$319.95
55800103	Satin Black.	\$319.95

See your Dealer for cables, lines and additional installation components required, or visit www.H-D.com/store and search part number 55800198 or 55800103.



A. CHIZELED HANDLEBAR – SATIN BLACK (STREET BOB SHOWN)



B. CHIZELED LO HANDLEBAR



C. FAT CHIZELED HANDLEBAR – CHROME (SOFTAIL DELUXE SHOWN)



D. MINI-APE HANDLEBAR



E. MINI-APE HANDLEBAR



F. FXSB SOFTAIL REACH HANDLEBAR

CONTROLS 527

Handlebars – Sportster®/Dyna®/Softail®

D. MINI-APE HANDLEBAR*

Fists up! This mini-ape handlebar delivers a higher hand position to achieve a traditional look, a relaxed style, and more comfortable riding position for some riders. 1" diameter bar with 9.4" rise. Features a conservative rise and bend for rider comfort. The Gloss Black finish complements motorcycle styling. See Harley-Davidson® Handlebar Installation Requirements document for additional components required for installation.

55801284	Chrome.	\$199.95
Fits '22-Later RH975 and RH975S models.		

E. MINI-APE HANDLEBAR*

The 12" mini-ape chrome 1.0" diameter handlebar delivers a modestly higher hand position to achieve a traditional look, a relaxed style, and more comfortable riding position for some riders.

Fits '07-'22 XL883L, XL883N, XL1200CX, XL1200L, XL1200N, XL1200NS, XL1200T, XL1200V, XL1200X, XL1200XS, and '18-later FLDE, FLSL and FXLR models. Also fits '06-'17 FXDB and '96-'05 FXDWG models with Original Equipment handlebar P/N 58079-93. XL models require separate purchase of additional components.

55801003	Chrome.	\$107.95
55801272	Gloss Black.	\$107.95

See your Dealer for cables, lines and additional installation components required, or visit www.H-D.com/store and search part number 55801003 or 56075-07A.

F. FXSB SOFTAIL® REACH™ HANDLEBAR*

Shaped to provide the ideal balance of pull back and width, this chrome-plated bar places riders closer to the controls for a comfortable upright riding position. When combined with the Original Equipment Softail® Breakout® curved risers, the Reach™ Handlebar provides an overall pull back of 7.0". The 1.25" diameter handlebar can be internally wired for a clean look.

55800188	Chrome.	\$306.95
Fits '13-'17 FXSB models. Separate purchase of additional components required.		

See your Dealer for cables, lines and additional installation components required, or visit www.H-D.com/store and search part number 55800188.



*NOTE: Installation of some handlebars and risers may require a change in clutch and/or throttle cable and brake lines for some models. Handlebar height is regulated in many locations. Check local laws to ensure your motorcycle meets applicable regulations.

Model Family Fitment:

■ V-ROD	■ SPORTSTER	■ DYNA
■ SOFTAIL	■ TOURING	

*NOTE: Installation of some handlebars and risers may require a change in clutch and/or throttle cable and brake lines for some models. Handlebar height is regulated in many locations. Check local laws to ensure your motorcycle meets applicable regulations.

Notice: The prices appearing in this catalog are the manufacturer's suggested retail prices. Actual retail prices may vary.

Notice: The prices appearing in this catalog are the manufacturer's suggested retail prices. Actual retail prices may vary.

528 CONTROLS

Handlebars – Softail®

A. FUSED HANDLEBAR*

Combining the edgy profile of a classic Z bar with the knuckles-up feel of a mini-ape and the narrow width of a drag bar, the Fused Bar delivers a fistful of classic chopper attitude. And with muscular cast corners, the cast elbows eliminate sharp internal bends to simplify the internal wiring. The handlebar is 1.25" at the upright and handles and 1" diameter at the base to fit with Original Equipment 1" Handlebar Risers.

Fits '18-later FXBB, FXBBS, FXLR, FXLRS, FXST models. All models require separate purchase of additional components.

55801015 Chrome. **\$425.95**

55801016 Gloss Black. **\$425.95**

B. FUSED HANDLEBAR*

Combining the edgy profile of a classic Z bar with the knuckles-up feel of a mini-ape and the narrow width of a drag bar, the Fused Bar delivers a fistful of classic chopper attitude. And with muscular cast corners, the cast elbows eliminate sharp internal bends to simplify the internal wiring.

Fits '18-later ABS enabled FLFB, FLFBS, FXBR, FXBRS, FXFB, FXFBS and FXDRS, '14-'20 Road King®, and '15-'20 FLRT models. All models require separate purchase of additional components.

55801030 Chrome. **\$425.95**

55801029 Black. **\$425.95**



A. FUSED HANDLEBAR – CHROME



C. FUSED LO HANDLEBAR – CHROME



B. FUSED HANDLEBAR – BLACK



D. FUSED LO HANDLEBAR – BLACK

*NOTE: Installation of some handlebars and risers may require a change in clutch and/or throttle cable and brake lines for some models. Handlebar height is regulated in many locations. Check local laws to ensure your motorcycle meets applicable regulations.

Notice: The prices appearing in this catalog are the manufacturer's suggested retail prices. Actual retail prices may vary.

CONTROLS 529

Handlebars – Softail®

C. FUSED LO HANDLEBAR*

With a low-profile and compact Z-bar design, the Fused Lo Bar flexes iconic West Coast style. And with muscular cast corners, the cast elbows eliminate sharp internal bends to simplify the internal wiring. The handlebar is 1.25" at the upright and handles and 1" diameter at the base to fit with Original Equipment 1" Handlebar Risers.

Fits '18-later ABS enabled FLFL and FXLRS models. All models require separate purchase of additional components.

55801057 Gloss Black. **\$403.95**

D. FUSED LO HANDLEBAR*

The Fused Lo Handlebar is a new take on West Coast style. With a low-profile and compact Z-bar design, it delivers the classic club look. And with muscular cast corners, the cast elbows eliminate sharp internal bends to simplify the internal wiring.

Fits '18-later ABS enabled FLFB, FLFBS, FLFB, FXBR, FXBRS and FXDRS, '14-'20 Road King®, and '15-'20 FLRT models. All models require separate purchase of additional components.

55801058 Chrome. **\$403.95**

55801059 Satin Black. **\$403.95**

*NOTE: Installation of some handlebars and risers may require a change in clutch and/or throttle cable and brake lines for some models. Handlebar height is regulated in many locations. Check local laws to ensure your motorcycle meets applicable regulations.

Model Family Fitment:

V-ROD
 SPORTSTER
 DYNA

 SOFTAIL
 TOURING

Notice: The prices appearing in this catalog are the manufacturer's suggested retail prices. Actual retail prices may vary.

530 CONTROLS

Handlebars – Dyna®/Softail®/Road King®

A. 12" FAT MINI-APE HANDLEBAR*

This true 12" mid-rise Ape Handlebar is the perfect mix of comfort and style. This bar features a traditional shape that tapers from a narrow base to a wide-open stance, and provides a flatter hand position with slightly less of the turned-in shape that can put stress on your wrists. The 1.25" diameter fat bar is factory drilled to allow internal wiring, and finished in your choice of show-quality chrome or gloss black surfaces. Handlebar can be installed in the Original Equipment risers on models factory-equipped with 1.25" handlebars.

Fits '14-later Road King® excluding vehicles equipped with 4-point H-D® detachable docking kits and '18-later FLFB, FLFBS, FLSB, FLFL, FXBR, FXBRS, FXBB, FXBBS, FXDRS, FXFB, FXFBS, FXLR and FXST models. Models originally equipped with 1.0" handlebar will require separate purchase of 1.25" handlebar riser kit. All models require separate purchase of additional installation components.

55801326	Chrome.	\$273.95
55801327	Gloss Black.	\$273.95

See your Dealer for cables, lines and additional installation components required, or visit www.H-D.com/store and search part number 55800479 or 55800748.

Shown with:

1.25" FAT RISER KIT – STREET BOB® AND BREAKOUT®

Required for installation of 1.25" handlebars on FXBB Street Bob® models, this curved riser kit features a one-piece top clamp that is shaped to accept the Original Equipment clamp-mounted digital gauge package. Kit includes two curved risers and one-piece clamp.

55900157B	Gloss Black.	\$274.95
Fits '18-later FXBB, FXBBS, FXBR, FXBRS models.		

B. 12" FAT MINI-APE HANDLEBAR KIT WITH RISER*

Big and beefy in the chopper tradition, this 1.25" Mini-Ape Handlebar is the perfect finish to an old-school ride. Factory drilled to allow internal wiring, the show-quality chrome or black finish reflects your attention to custom details. This 12.0" high bar and riser combination provides the look and attitude you dream about, but remains comfortable over the long haul. Handlebar kit includes matching riser and custom handlebar clamp that conceals the wire exit for a clean look.

Fits '12-'16 FLD, '06-'17 FXDB, '08-'17 FXDF, '16-'17 FXDLS, '99-'17 FXDWG, '00-'17 FLS, FLSS, FLSTC, FLSTF, FLSTFB, FLSTFBS, FLSTN, FXCW, FXCWC, FXST, FXSTB, FXSTC, '18-later Softail® (except FLSB, FXBB, FXBBS, FXBR, FXBRS, FXDRS, FXFB, FXFBS, FXLRS, FXLRST and FXST), and '03-later Road King models. All models require separate purchase of additional installation components. Fits with Accessory Heated Grips (except FLHTK Heated Grips or Black Rubber Accessory Heated Grips). Does not fit with Hydraulic Clutch Kits, handlebar-mounted gauges, or Softail® Freight Train Nacelle Kit. Satin Black kit features gloss black risers.

55801313	Chrome.	\$327.95
55801311	Black.	\$327.95

See your Dealer for cables, lines and additional installation components required, or visit www.H-D.com/store and search part number 55801313 or 55801311.

*NOTE: Installation of some handlebars and risers may require a change in clutch and/or throttle cable and brake lines for some models. Handlebar height is regulated in many locations. Check local laws to ensure your motorcycle meets applicable regulations.

Notice: The prices appearing in this catalog are the manufacturer's suggested retail prices. Actual retail prices may vary.



A. 12" FAT MINI-APE HANDLEBAR



B. 12" FAT MINI-APE HANDLEBAR KIT WITH RISER – CHROME



C. 16" FAT APE HANDLEBAR



D. 16" FAT APE HANDLEBAR KIT WITH RISER – SATIN BLACK

CONTROLS 531

Handlebars – Dyna®/Softail®/Road King®

C. 16" FAT APE HANDLEBAR*

This beefy 16" Fat Ape handlebar is shaped to give even the tallest rider the hands-in-the-air riding position. The bar features a flatter hand position that positions your wrists in a neutral position for long ride comfort. This true-height 16" bar can be installed in the Original Equipment risers on models factory-equipped with 1.25" handlebars, and the bar is pre-drilled to allow internal wiring. Available in your choice of chrome or gloss black finish, these bars are ready to deliver your custom attitude.

Fits '18-later FLFB, FLFBS, FLSB, FLFL, FXBR, FXBRS, FXBB, FXDRS, FXFB, FXFBS, FXLR and FXST models. '14-later Road King® (except vehicles equipped with 4-point H-D detachable docking kits). Models originally equipped with 1.0" handlebar will require separate purchase of 1.25" handlebar riser kit. All models require separate purchase of additional installation components.

55801325	Chrome.	\$294.95
55801324	Gloss Black.	\$294.95

See your Dealer for cables, lines and additional installation components required, or visit www.H-D.com/store and search part number 55800750 or 55800751.

D. 16" FAT APE HANDLEBAR KIT WITH RISER*

Reach for the sky. This brawny 1.25" Ape Handlebar is the ideal choice for the long-armed rider or anyone looking for that classic fists-in-the-wind riding profile. Factory drilled to allow internal wiring, the show-quality chrome or satin-black finish complements your bike's overall design sense. This 16.0" high bar and riser combination provides the look you crave around town and the bar can be rotated in the clamp and locked down to place your hands in your ideal open-road riding position. Handlebar kit includes matching riser and custom handlebar clamp that conceals the wire exit for a clean look.

Fits '12-'16 FLD, '06-'17 FXDB, '08-'17 FXDF, '16-'17 FXDLS, '99-'17 FXDWG, '00-'17 FLS, FLSS, FLSTC, FLSTF, FLSTFB, FLSTFBS, FLSTN, FXCW, FXCWC, FXST, FXSTB and FXSTC, '18-later FLFB, FLFBS, FLSB, FLFL, FXDRS and FXLR, and '03-later Road King models. All models require separate purchase of additional installation components. Does not fit with Hydraulic Clutch Kits, handlebar-mounted gauges, or Softail® Freight Train Nacelle Kit. Satin Black kit features gloss black risers.

55801317	Chrome.	\$347.95
55801315	Satin Black.	\$347.95

See your Dealer for cables, lines and additional installation components required, or visit www.H-D.com/store and search part number 55801317 or 55801315.

*NOTE: Installation of some handlebars and risers may require a change in clutch and/or throttle cable and brake lines for some models. Handlebar height is regulated in many locations. Check local laws to ensure your motorcycle meets applicable regulations.

Model Family Fitment:

 V-ROD	 SPORTSTER	 DYNA
 SOFTAIL	 TOURING	

Notice: The prices appearing in this catalog are the manufacturer's suggested retail prices. Actual retail prices may vary.

532 CONTROLS

Handlebars – Road King®

A. ROAD KING® FAT HANDLEBAR*

Similar to Original Equipment handlebar on the '14 CVO™ Road King® model, this beefy 1.25" handlebar places the rider in a laid-back riding posture. This handlebar provides 2.0" of additional pull back and a 1.0" lower hand position than the Original Equipment Road King bar. The 1.25" diameter bar allows you to tuck the wires inside the bar for a clean, custom look.

55801332 Chrome. **\$273.95**
Fits '14-later Road King® models. All models require separate purchase of additional components for installation.

See your Dealer for cables, lines and additional installation components required, or visit www.H-D.com/store and search part number 55801332.

B. ROAD KING/ROAD GLIDE® HERITAGE STYLE HANDLEBAR*

Designed to provide extra touring comfort for the Road King or Road Glide® rider, this 1.0" diameter stainless steel bar has 3.0" more pull back compared to the stock '08-'13 Road King handlebar. Heritage Bar has the same dimensions as the '14-later Road King Original Equipment bar.

56902-08 Polished Stainless Steel. **\$107.95**
Fits '08-later FLHR and FLHRC and '08-'13 FLTR, FLTRU, and FLTRX models. All models require separate purchase of additional components for installation.

See your Dealer for cables, lines and additional installation components required, or visit www.H-D.com/store and search part number 55684-09 or 56902-08.



A. ROAD KING FAT HANDLEBAR – CHROME



C. ROAD KING/ROAD GLIDE REACH HANDLEBAR



B. ROAD KING/ROAD GLIDE HERITAGE STYLE HANDLEBAR



D. ROAD KING/ROAD GLIDE TALLBOY HANDLEBAR



Reach Handlebars



Tallboy Handlebars

*NOTE: Installation of some handlebars and risers may require a change in clutch and/or throttle cable and brake lines for some models. Handlebar height is regulated in many locations. Check local laws to ensure your motorcycle meets applicable regulations.

Notice: The prices appearing in this catalog are the manufacturer's suggested retail prices. Actual retail prices may vary.

CONTROLS 533

Handlebars – Road King®/Road Glide®

C. ROAD KING®/ROAD GLIDE® REACH™ HANDLEBAR*

This 1.0" diameter chrome bar has 2.0" more pull back compared to the stock Road King® handlebar. Accepts internal wiring for a clean look. The neutral hand position is comfortable for the long haul and the narrow hand width and pull back design produces a major ergonomic change.

56166-08 Chrome. **\$113.95**
Fits '08-later FLHR and FLHRC, '08-'13 FLTR, FLTRU and FLTRX models. Does not fit FLHRXS models. Does not fit '08 ABS equipped models, Sidecar-equipped models or Handlebar Mounted Gauges. All models require separate purchase of additional components for installation. Compatible with accessory heated grips (except FLHTK Heated Grips or Black Rubber Heated Hand Grips P/N 56100034).

See your Dealer for cables, lines and additional installation components required, or visit www.H-D.com/store and search part number 56166-08.

D. ROAD KING/ROAD GLIDE/FREEWHEELER® TALLBOY™ HANDLEBAR*

Designed to provide extra touring comfort for the Road King rider, this 1.0" diameter chrome bar is 2.0" higher and 1.5" narrower compared to the stock Road King handlebar.

56180-08 Chrome. **\$107.95**
Fits '08-later FLHR and FLHRC, '08-'13 FLTR, FLTRU, FLTRX, and '15-'20 FLRT models. Does not fit FLHRXS models. Does not fit '08 ABS equipped models, Sidecar-equipped models or Handlebar Mounted Gauges. All models require separate purchase of additional components for installation. Compatible with accessory heated grips (except FLHTK Heated Grips or Black Rubber Heated Hand Grips P/N 56100034).

See your Dealer for cables, lines and additional installation components required, or visit www.H-D.com/store and search part number 56180-08.

Also available: (not shown)

ROAD KING/ROAD GLIDE TALLBOY HANDLEBAR* – '96-'07 MODELS

Designed to provide extra comfort for the Road King rider, this chrome bar is 4.5" higher and 2.0" narrower than the stock handlebar found on '96-'99 Road King models and 3.5" higher and 1.5" narrower than stock handlebar on '00-'01 Road King models. Many models require no additional cables or hoses for installation.

55954-00 Chrome. **\$107.95**
Fits '96-'07 Road King and '02-'07 Road Glide® models. Does not fit CVO™ models with 1.25" handlebars.

See your Dealer for cables, lines and additional installation components required, or visit www.H-D.com/store and search part number 55954-00.

*NOTE: Installation of some handlebars and risers may require a change in clutch and/or throttle cable and brake lines for some models. Handlebar height is regulated in many locations. Check local laws to ensure your motorcycle meets applicable regulations.

Model Family Fitment:

V-ROD
 SPORTSTER
 DYNA

 SOFTAIL
 TOURING

Notice: The prices appearing in this catalog are the manufacturer's suggested retail prices. Actual retail prices may vary.

534 CONTROLS

Handlebars – Batwing

CHOOSE YOUR BATWING HANDLEBAR

Just about every model of Harley-Davidson® motorcycle features a different stock handlebar. Selected to complement the style or use of the bike, the handlebar may be the ideal shape for many riders, but of course, not everyone has the same physical characteristics.

Choosing a bar for your batwing fairing-equipped model is about more than just style – it's about how you approach the road. Where the bar positions your hands, wrists and arms directly affects how you feel on your motorcycle. For every set of bars, there are three factors at work: rise, pull back and width. These three measurements determine your reach to the hand controls and, therefore, your overall feeling of comfort and control.

A. ELECTRA GLIDE® CHROME HANDLEBAR*

Replace your stock polished bar with this 1.0", chrome handlebar that allows you to tuck the wires inside the bar for a clean, finished look. Identical shape to the Original Equipment Electra Glide and Street Glide® bar, this high-quality chrome-plated handlebar is designed to be compatible for use with TGS-equipped Electra Glide® models.

56036-08 Chrome. **\$165.95**
Fits '09-later Electra Glide®, Street Glide® and Ultra Limited™ models (except CVO™). Does not fit Trike models. All models require separate purchase of additional components.

See your Dealer for cables, lines and additional installation components required, or visit www.H-D.com/store and search part number 56036-08.



BATWING STOCK HANDLEBAR



BATWING REACH HANDLEBAR



BATWING CHIZELED HANDLEBAR



BATWING MINI APE HANDLEBAR



A. ELECTRA GLIDE CHROME HANDLEBAR



B. BATWING REACH HANDLEBAR



C. BATWING TALLBOY HANDLEBAR



Reach Handlebars



Tallboy Handlebars

*NOTE: Installation of some handlebars and risers may require a change in clutch and/or throttle cable and brake lines for some models. Handlebar height is regulated in many locations. Check local laws to ensure your motorcycle meets applicable regulations.

Model Family Fitment:

V-ROD
 SPORTSTER
 DYNA

 SOFTAIL
 TOURING

Notice: The prices appearing in this catalog are the manufacturer's suggested retail prices. Actual retail prices may vary.

CONTROLS 535

Handlebars – Batwing

B. BATWING REACH™ HANDLEBAR*

The Batwing Reach™ Handlebar is shaped to provide all-day riding comfort for smaller-stature riders. Extensively tested by a panel of riders who stand 5'-1" to 5'-5" tall, the Reach Handlebar was ergonomically designed to provide the ideal combination of shoulder position, elbow bend and wrist angle. The bar brings the grips closer to the rider, and features a narrower width, lower height and flatter hand position. The narrow profile also brings the hands in toward the center of the vehicle for easier maneuvering.

Combining a Reach™ Seat with a Reach Handlebar provides a smaller-stature rider with an optimized rider triangle and a complete fit solution.

Fits '09-later Electra Glide®, Street Glide®, Ultra Limited (except '10-'13 FLHTK) and '09-later Trike models (except Freewheeler®). Also fits '17-later FLHTKSE and FLHXSE models. All models require separate purchase of additional components. Street Glide models and models with fairing-mount mirrors require separate purchase of handlebar-mounted mirrors and Fairing Plugs. Does not fit with Original Equipment Heated Grips or accessory Black Rubber Heated Hand Grips P/N 56100034.

55800589	Chrome.	\$183.95
55800590	Gloss Black.	\$170.95

See your Dealer for cables, lines and additional installation components required, or visit www.H-D.com/store and search part number 55800589 or 55800590.

Also available: (not shown)

BATWING REACH HANDLEBAR*

These high-quality handlebars are designed to bring the controls 2.0" closer to the rider for increased comfort. Especially helpful for shorter riders or those with short arms.

55914-98 Polished Stainless Steel. **\$165.95**
Fits '02-'07 Electra Glide and Street Glide models. All models require separate purchase of additional components. '08-'13 FLHX and models with fairing-mount mirrors require separate purchase of handlebar-mounted mirrors and Fairing Plugs P/N 732 (Qty 2) and 755 (Qty 2). Does not fit models equipped with Hydraulic Clutch Kits or Sidecar.

See your Dealer for cables, lines and additional installation components required, or visit www.H-D.com/store and search part number 55914-98.

C. BATWING TALLBOY™ HANDLEBAR*

The Batwing Tallboy™ Handlebar is shaped to provide a tall rider with the ideal combination of shoulder, elbow and wrist positions for a long day in the saddle. The Tallboy handlebar was extensively tested by a panel of riders between 5'-11" and 6'-3" tall, resulting in a higher and flatter hand location. The bar also stretches the elbow to a natural angle, and reduces the cramped look often seen in riders with long arms.

Combining a Tallboy™ Seat with a Tallboy Handlebar provides the rider with an optimized rider triangle and a complete fit solution.

Fits '09-later Electra Glide®, Street Glide®, Ultra Limited™ (except '10-'13 FLHTK) and '09-later Trike models (except Freewheeler™). Does not fit CVO™ models. All models require separate purchase of additional components. Street Glide® models and models with fairing-mount mirrors require separate purchase of handlebar-mounted mirrors and Fairing Plugs. Does not fit with stock heated grips or accessory Black Rubber Heated Hand Grips P/N 56100034.

55800591	Chrome.	\$178.95
55800592	Gloss Black.	\$170.95

See your Dealer for cables, lines and additional installation components required, or visit www.H-D.com/store and search part number 55800591 or 55800592.

*NOTE: Installation of some handlebars and risers may require a change in clutch and/or throttle cable and brake lines for some models. Handlebar height is regulated in many locations. Check local laws to ensure your motorcycle meets applicable regulations.

Notice: The prices appearing in this catalog are the manufacturer's suggested retail prices. Actual retail prices may vary.

536 CONTROLS

Handlebars – Batwing

A. FUSED HANDLEBAR – BATWING FAIRING*

Bad to the bone attitude never looked so good. Combining the rise of a mini-ape with the edgy profile of a classic Z bar, the Batwing Fused Bar delivers the renegade, fists-in-the-wind riding style you crave. And with muscular cast corners, the cast elbows eliminate sharp internal bends to simplify the internal wiring. The 1.25" bar slims down to 1" at the base to fit with the Original Equipment handlebar clamps.

Fits '14-later ABS enabled Electra Glide®, Street Glide®, Ultra Limited, and Tri Glide® models. Does not fit FLHTKSE models. All models require separate purchase of additional components.

55801004	Chrome.	\$425.95
55801005	Gloss Black.	\$425.95

B. FUSED LO HANDLEBAR* - BATWING FAIRING*

Tuck and ride in style. With a low-slung rise, flat dragbar hand position and compact Z-bar design, the Batwing Fused Lo Bar places the rider in an aggressive riding posture with optimal wrist position and elbow bend for supreme riding comfort. And with muscular cast corners, the cast elbows eliminate sharp internal bends to simplify the internal wiring. The 1.25" bar slims down to 1" at the base to fit with the Original Equipment handlebar clamps.

Fits '14-later ABS enabled Electra Glide, Street Glide, Ultra Limited, and Tri Glide models. Does not fit FLHTKSE models. All models require separate purchase of additional components.

55801060	Chrome.	\$403.95
55801061	Gloss Black.	\$403.95

See your Dealer for cables, lines and additional installation components required, or visit www.H-D.com/shop and search part number 55801060 or 55801061.



A. FUSED HANDLEBAR



B. FUSED LO HANDLEBAR

CONTROLS 537

Handlebars – Batwing

C. BATWING MINI-APE HANDLEBAR*

Throw your fists in the air with these 12.0" ape handlebar. A favorite among long-armed riders, these bars are shaped to rest your hands just above the top of the classic batwing fairing. The bars feature a tall stance and minimal amount of pull back that help to achieve a cool yet comfortable riding profile. Finished in brilliant chrome or satin black, these 1.0" handlebars accept internal wiring for a clean look.

Fits '09-later Electra Glide®, Street Glide®, Ultra Limited (except '10-'13 FLHTK) and Trike (except FLRT) models. Does not fit CVO™ models. All models require separate purchase of additional components for installation. '09-'13 FLHX and models with fairing-mount mirrors require separate purchase of handlebar-mounted mirrors and Fairing Plugs. Does not fit with Original Equipment Heated Grips or accessory Black Rubber Heated Hand Grips P/N 56100034.

57474-11	Chrome.	\$206.95
57485-11	Satin Black.	\$206.95

See your Dealer for cables, lines and additional installation components required, or visit www.H-D.com/store and search part number 57474-11 or 57485-11.

D. BATWING CHIZELED HANDLEBAR*

Bring cutting edge style to your custom bagger. The Batwing Chizeled Bar combines the rise of a 12" mini-ape with the edgy profile of the classic Z bar and the wrist position of a drag bar. The result? An aggressive hands-in-the-air riding posture. The fat 1.25" bar replaces mitered and welded corners with cast seamless 90° bends for added strength and style. The cast elbows eliminate sharp internal bends to simplify internal wiring. The bar slims down to 1.0" at the base to fit with Original Equipment handlebar clamps.

Fits '14-later Electra Glide, Electra Glide Standard, Street Glide, Ultra Limited and Tri Glide® models. All models require separate purchase of additional components for installation. Street Glide models and models with fairing-mounted mirrors require separate purchase of handlebar-mounted mirrors and fairing plugs. Does not fit with Heated Hand Grips. Does not fit CVO models.

55800863	Gloss Black.	\$403.95
-----------------	--------------	-----------------

See your Dealer for cables, lines and additional installation components required, or visit www.H-D.com/store and search part number 55800863.



C. BATWING MINI-APE HANDLEBAR



D. BATWING CHIZELED HANDLEBAR

*NOTE: Installation of some handlebars and risers may require a change in clutch and/or throttle cable and brake lines for some models. Handlebar height is regulated in many locations. Check local laws to ensure your motorcycle meets applicable regulations.

Notice: The prices appearing in this catalog are the manufacturer's suggested retail prices. Actual retail prices may vary.

*NOTE: Installation of some handlebars and risers may require a change in clutch and/or throttle cable and brake lines for some models. Handlebar height is regulated in many locations. Check local laws to ensure your motorcycle meets applicable regulations.

Notice: The prices appearing in this catalog are the manufacturer's suggested retail prices. Actual retail prices may vary.

538 CONTROLS

Handlebars – Road Glide

CHOOSE YOUR ROAD GLIDE® HANDLEBAR

Just about every model of Harley-Davidson® motorcycle features a different stock handlebar. Selected to complement the style or use of the bike, the handlebar may be the ideal shape for many riders, but of course, not everyone has the same physical characteristics.

Choosing a bar for your Road Glide® model is about more than just style – it's about how you approach the road. Where the bar positions your hands, wrists and arms directly affects how you feel on your motorcycle. For every set of bars, there are three factors at work: rise, pull back and width. These three measurements determine your reach to the hand controls and, therefore, your overall feeling of comfort and control.

A. ROAD GLIDE TALLBOY™ HANDLEBAR*

This 1.25" diameter bar features an optimized ergonomic design for taller and long-limbed riders. The bar is 2" taller than the Original Equipment handlebar, and is sized to accept internal wiring for a clean look.

Fits '15-later FLTRX, FLTRXS and FLTRU models. All models require separate purchase of additional components. Does not fit CVO™ models (except '20 FLTRXSE). Fits with Accessory Heated Grips. Compatible with accessory heated grips (except FLHTK Heated Grips or Black Rubber Heated Hand Grips P/N 56100034).

55800550A	Chrome.	\$297.95
55800551A	Satin Black.	\$297.95

See your Dealer for cables, lines and additional installation components required, or visit www.H-D.com/store and search part number 55800550A or 55800551A.

B. ROAD GLIDE FAT APE HANDLEBAR*

Hang'em high. Across town or cross country, this classic-shaped Fat Ape Handlebar adds a touch of old school style to your modern urban bagger. Designed for Road Glide models, this beefy 1.25" bar features 15" of rise and a shape that provides a cool yet comfortable riding profile. Available in your choice of finish, this fat bar accepts internal wiring for a show-quality look that's built for the open road.

Fits '15-later FLTRX, FLTRXS and FLTRU models. All models require separate purchase of additional components. Does not fit CVO™ models (except '20 FLTRXSE). Fits with Accessory Heated Grips. Does not fit with the FLHTK Heated Grips (or Black Rubber Heated Hand Grip Kit P/N 56100034).

55800548A	Chrome.	\$307.95
55800549A	Satin Black.	\$307.95

See your Dealer for cables, lines and additional installation components required, or visit www.H-D.com/store and search part number 55800548A or 55800549A.



A. ROAD GLIDE TALLBOY HANDLEBAR



B. ROAD GLIDE FAT APE HANDLEBAR – SATIN BLACK



C. FUSED HANDLEBAR



D. FUSED LO HANDLEBAR

CONTROLS 539

Handlebars – Road Glide

C. FUSED HANDLEBAR – ROAD GLIDE®*

Bad to the bone attitude never looked so good. Combining the rise of a mini-ape with the edgy profile of a classic Z bar and the wrist position of a drag bar, the Road Glide Fused Bar delivers the renegade, fists-in-the-wind riding style you crave. And with muscular cast corners, the cast elbows eliminate sharp internal bends to simplify the internal wiring.

Fits '15-later ABS enabled Road Glide® models. All models require separate purchase of additional components. Does not fit '19-later CVO™ models.

55801007	Chrome.	\$425.95
55801006	Gloss Black.	\$425.95

D. FUSED LO HANDLEBAR* – ROAD GLIDE®*

Tuck and ride in style. With a low-slung 9.0" rise, flat drag-bar hand position and compact Z-bar design, the Road Glide® Fused Lo Bar places the rider in an aggressive riding posture with optimal wrist position and elbow bend for supreme riding comfort. And with muscular cast 90° corners, the cast elbows eliminate sharp internal bends to simplify the internal wiring.

Fits '15-later ABS enabled Road Glide models. All models require separate purchase of additional components. Does not fit CVO models.

55801062	Chrome.	\$403.95
55801063	Gloss Black.	\$403.95

See your Dealer for cables, lines and additional installation components required, or visit www.H-D.com/store and search part number 55800862 or 5580863.

*NOTE: Installation of some handlebars and risers may require a change in clutch and/or throttle cable and brake lines for some models. Handlebar height is regulated in many locations. Check local laws to ensure your motorcycle meets applicable regulations.

Model Family Fitment:

 V-ROD	 SPORTSTER	 DYNA
 SOFTAIL	 TOURING	

Notice: The prices appearing in this catalog are the manufacturer's suggested retail prices. Actual retail prices may vary.

*NOTE: Installation of some handlebars and risers may require a change in clutch and/or throttle cable and brake lines for some models. Handlebar height is regulated in many locations. Check local laws to ensure your motorcycle meets applicable regulations.

Notice: The prices appearing in this catalog are the manufacturer's suggested retail prices. Actual retail prices may vary.

540 CONTROLS

Handlebar – Road Glide®

A. ROAD GLIDE® CHIZELED LO HANDLEBAR*

With a low 9.0" rise and a flat drag-bar hand position, this compact Z bar will place the rider into an aggressive, tucked-in riding posture. Many Road Glide® motorcycle riders feel this is our most comfortable handlebar, with optimal wrist position and elbow bend. The 1.25" Chizeled Bar replaces mitered and welded corners with cast seamless 90° bends for added strength and style. The cast elbows eliminate sharp internal bends and the bar features removable Bar & Shield plugs to simplify internal wiring. Bars are available in brilliant chrome or gloss black finishes to match your bike's custom direction.

Fits '15-later FLTRX and FLTRXS models. Does not fit '18-later FLTRXSE or models equipped with 21" Knockout™ Wheel Kit P/N 43300494 or 43300496. All models require separate purchase of additional components. Does not fit CVO™ models. Compatible with accessory heated grips (except FLHTK Heated Grips or Black Rubber Heated Hand Grips P/N 56100034).

55800568	Chrome.	\$372.95
55800569	Gloss Black.	\$372.95

See your Dealer for cables, lines and additional installation components required, or visit www.H-D.com/store and search PART number 55800568 or 55800569.

B. ROAD GLIDE CHIZELED HANDLEBAR*

Bring cutting-edge style to your custom bagger. The Road Glide Chizeled Bar combines the rise of a 14" mini-ape with the edgy profile of the classic Z bar and the wrist position of a drag bar. The result? An aggressive hands-in-the-air riding posture. The fat 1.25" bar replaces mitered and welded corners with cast seamless 90° bends for added strength and style. The cast elbows eliminate sharp internal bends and the bar features removable Bar & Shield plugs to simplify internal wiring.

Fits '15-later FLTRK, FLTRU, FLTRX and FLTRXS models. Does not fit '18-later FLTRXSE or models equipped with 21" Knockout™ Wheel Kit P/N 43300494 or 43300496. All models require separate purchase of additional components. Does not fit CVO™ models. Does not fit models with Black Rubber Heated Hand Grip Kit P/N 56100034.

55800439	Chrome.	\$403.95
55800440	Gloss Black.	\$403.95

See your Dealer for cables, lines and additional installation components required, or visit www.H-D.com/store and search part number 55800439 or 55800440.



A. ROAD GLIDE CHIZELED LO HANDLEBAR



B. ROAD GLIDE CHIZELED HANDLEBAR

*NOTE: Installation of some handlebars and risers may require a change in clutch and/or throttle cable and brake lines for some models. Handlebar height is regulated in many locations. Check local laws to ensure your motorcycle meets applicable regulations.

Model Family Fitment:

- V-ROD
- SPORTSTER
- DYNA
- SOFTAIL
- TOURING

Notice: The prices appearing in this catalog are the manufacturer's suggested retail prices. Actual retail prices may vary.

CONTROLS 541

HANDLEBAR RISERS

You may think you are perfectly happy with the way your bike is adjusted. But that doesn't mean that it is correctly set up for you. We get used to our bikes – our muscles become trained and we end up accommodating the bike. It is far better to take the time to make the bike accommodate you. If you are satisfied with your handlebar's width and wrist position, but wish it was just a little higher, lower or closer to you, your dealer can recommend a set of handlebar risers that move the bar into your comfort zone.

ADJUSTING YOUR HAND POSITION



STOCK HANDLEBAR

Just about every model of Harley-Davidson® motorcycle comes with a different stock handlebar. Selected to complement the style of the bike, the handlebar may be the ideal shape for many riders, but of course, not everyone has the same physical characteristics.



STOCK HANDLEBAR WITH RISERS

If the stock handlebar has the correct width and hand position for you, but seems just a little too far away, we offer riser kits that bring the controls within reach. Straight and curved risers are available for many model and handlebar combinations.

ORIGINAL EQUIPMENT RISER DIMENSIONS

DESCRIPTION	BAR DIAMETER (IN)	HEIGHT (IN)	PULL BACK (IN)	FINISH
Road King®, Batwing Touring & Trike	1.00	1.70	0.00	Cast Alum
Road Glide®	1.25	1.70	0.00	Cast Alum
Softail® – FLSTC, FLS & FLSS	1.00	1.94	0.39	Chrome/Black
Softail – FLSTF, FLSTFB & FLSTFBS	1.25	2.40	0.87	Chrome/Black
Softail – FLSTN	1.00	4.45	1.30	Chrome
Softail – FXSB	1.25	4.00	1.15	Chrome
Dyna® – FLD	1.00	3.10	1.18	Chrome
Dyna – FXDB	1.00	1.00	n/a	Polished Alum
Dyna – FXDL	1.00	4.39	1.61	Polished Alum
Dyna – FXDF & FXDWG	1.25	5.00	0.60	Gloss Black
XL – 1200C	1.00	4.73	1.13	Chrome
XL – 883N	1.00	2.07	0.00	Wrinkle Black
XL – 883L & 1200T	1.00	2.07	0.00	Black
XL – 1200L, 1200CP & 1200V	1.00	1.86	0.00	Chrome
XL – 1200CX	1.00	1.21	0.00	Black
XL – 1200X	1.00	0.94	n/a	Gloss Black
VRSC™ – VRSCD & VRSCDX	1.00	2.68	0.40	Black

ACCESSORY RISER DIMENSIONS*

KIT P/N	DESCRIPTION	BAR DIAMETER (IN)	HEIGHT (IN)	PULL BACK (IN)	FINISH
55996-09	Black Fat Risers	1.25	5.0	0.6	Gloss Black
56269-09	Curved Pull Back, 4.0"	1.25	4.0	1.3	Chrome
56267-09	Curved Pull Back, 6.0"	1.25	6.0	1.7	Chrome
56066-82A	Curved Riser, 4.0"	1.00	4.4	1.5	Chrome
56266-09	Curved Riser, 6.0"	1.00	6.0	1.7	Chrome
55900023	Deluxe Pull Back Riser	1.00	4.4	0.8	Chrome
55900122	Fat Riser	1.25	1.0	0.0	Chrome
55900123	Fat Riser	1.25	1.0	0.0	Gloss Black
55900165	Slim Pull Back Riser	1.00	4.5	1.5	Gloss Black
55900166	Clamp and Riser Kit	1.00	1.0	0.0	Gloss Black
55900194	Clamp and Riser Kit	1.25	2.6	0.1	Gloss Black
55800852	Tall Riser	1	5.5	0	Black Anodize
55800854	Tall Riser	1.25	5.5	0	Black Anodize
56929-10	Fat One-Piece Riser, Chrome	1.25	4.1	0.0	Chrome
56916-07	Fat-Bar Risers	1.25	3.6	0.0	Chrome
46809-09	Riser Kit for Nacelle	1.00	1.9	0.0	Chrome
56063-82A	Straight Riser, 4.0"	1.00	4.0	0.0	Chrome

*NOTE: Installation of some handlebars and risers may require a change in clutch and/or throttle cable and brake lines for some models. Handlebar height is regulated in many locations. Check local laws to ensure your motorcycle meets applicable regulations.

542 CONTROLS

Handlebar Risers

A. TALL HANDLEBAR RISER – BLACK ANODIZED

This 5.5" riser kit gives your bike a "club"-style look along with the versatility of a traditional riser and handlebar combination. Aggressive, muscular styling combines with a black anodized finish to help you complete an eye-catching performance look. Available in 1.0" and 1.25" sizes. Top clamp sold separately.

55800854 1.25" **\$180.95**
Fits '18-later FLFB, FLFBS, FLFL, FXBB, FXBBS, FXBR, FXBRS, FXDRS, FXFB, FXFBS, FXLR, FXLRS, FXST, '14-later Road King® models. Requires separate purchase of appropriate top clamp. Moto bar on stock and tall risers does not fit with accessory windshields on FLFB, FXBR and FXBB, FXBBS models.

55800852 1" **\$180.95**
Fits '18-later FLFL, FXBB, FXBBS, FXLR, FXLRS, FXST, and '14-later Road King models. Requires separate purchase of appropriate top clamp. Moto bar on stock riser or tall riser does not fit with quarter fairing or accessory windshields on FXBB and FXBBS models.



A. TALL HANDLEBAR RISER – BLACK ANODIZED

B. GAUGE CLAMP KIT – BLACK

Required for installation of tall risers. Designed for motorcycles equipped with the standard digital gauge in the riser. Aluminum construction reduces weight, with aggressive, muscular styling to help complete an overall performance look on your motorcycle. Available for 1.0" or 1.25" diameter handlebars.

55900228 1.25" **\$180.95**
Fits '18-later FXBB, FXBBS, FXBR, FXBRS, FXDRS, FXST models equipped with Tall Riser Kit P/N 55800854.

55900227 1" **\$180.95**
Fits '18-later FXBB, FXBBS, FXBR, FXBRS, FXDRS, FXST models equipped with Tall Riser Kit P/N 55800852.



B. GAUGE CLAMP KIT – BLACK

C. HANDLEBAR TOP CLAMP KIT – BLACK

Required for installation of tall risers. Designed for motorcycles without the digital gauge in the riser. Aluminum construction reduces weight, with aggressive, muscular styling to help complete an overall performance look on your motorcycle. Available for 1.0" or 1.25" diameter handlebars.

55900237 1.25" **\$76.95**
Fits '18-later FLFB, FLFBS, FLFL, FXFB, FXFBS, FXLR and FXLRS, and '14-'20 Road King models equipped with Tall Riser Kit P/N 55800854.

55900238 1" **\$76.95**
Fits '18-later FXLR, FLFL, FXLRS and '14-later Road King models equipped with Tall Riser Kit P/N 55800852.



C. HANDLEBAR TOP CLAMP KIT – BLACK

D. HANDLEBAR RISER & CLAMP KIT – GLOSS BLACK

Required for installation of 1.25" handlebars on select '18-later Softail® models. This straight riser gives different hand position, placing your hands and arm higher. Features a one-piece top clamp that is shaped to accept the Original Equipment clamp-mounted digital gauge package. Kit includes two curved risers and one-piece clamp.

55900194 **\$278.95**
Fits '18-later FXBB, FXBBS, FXBR, FXBRS, FXDRS models.



D. HANDLEBAR RISER & CLAMP KIT – GLOSS BLACK

Model Family Fitment:

- V-ROD
- SPORTSTER
- DYNA
- SOFTAIL
- TOURING

Notice: The prices appearing in this catalog are the manufacturer's suggested retail prices. Actual retail prices may vary.

CONTROLS 543

Handlebar Risers

E. FAT HANDLEBAR RISER KIT*

Designed to enable the installation of a 1.25" handlebar on models originally equipped with a 1.0" bar, these low-profile risers feature a one-piece top clamp for added support and style. Available in mirror chrome or gloss black finish, these kits include matching installation hardware.

Fits '18-later FLDE, FLFB, FLFBS, FLHC, FLCS, FLFB, FLFL, and FXLR models.

55900122 Chrome. **\$163.95**
55900123 Gloss Black. **\$163.95**



E. FAT HANDLEBAR RISER KIT – GLOSS BLACK

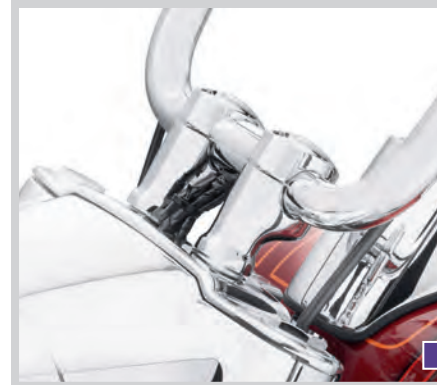

E. FAT HANDLEBAR RISER KIT – CHROME

F. HANDLEBAR CLAMP & RISER KIT – GLOSS BLACK*

Go for a total blackout. Replace your Original Equipment Riser. Includes all necessary mounting hardware.

55900166 **\$191.95**
Fits '18-later Softail® models (except FXBB, FXBBS, FXBR, FXBRS, FXDRS and FXST) equipped with 1" handlebars.



G. FAT RISER KIT – CHROME



F. HANDLEBAR CLAMP & RISER KIT – GLOSS BLACK

G. FAT RISER KIT – CHROME*

This riser features a one-piece base that is designed for use with internally wired 1.25" handlebars and provides a skirt that conceals the wiring's exit from the bar. The matching handlebar clamp ties it all together. Available in mirror chrome finish, the kit includes riser, matching handlebar clamp and clamp hardware.

56929-10 **\$163.95**
Fits most 1.25" diameter handlebars. Does not fit FXSB, FXSBSE, FXBB, FXBBS, FXBR, FXBRS, FXST and Springer™ models or '21-later Touring and Trike models. Requires separate purchase of additional components. Riser height 4.1". See your dealer for details.

H. FAT BAR RISER KIT – CHROME*

Go phat with bold chrome-plated risers. Hidden fasteners create a clean, seamless look. Kit includes all necessary mounting hardware.

56916-07 **\$163.95**
Fits most 1.25" diameter handlebars. Does not fit FXSB, FXSBSE, FXBB, FXBBS, FXBR, FXBRS, FXST and Springer™ models. Requires separate purchase of additional components. Riser height 3.6". See your dealer for details.



H. FAT BAR RISER KIT – CHROME

I. CURVED PULL BACK FAT RISERS – CHROME*

These chrome-plated Curved Pull Back Risers provide a comfortable riding position for those who like the shape, width and hand position of their current handlebar, but wish it was closer. For an ergonomically friendly ride, these risers can be combined with a Harley-Davidson® Reach® Seat and Profile® Low suspension components to reduce arm stretch and to plant the feet firmly on the ground.

Fits most 1.25" handlebars. Does not fit FXSB, FXSBSE, FXBB, FXBBS, FXBR, FXBRS, FXST and Springer™ models. Requires separate purchase of additional components. See your dealer for details.

56269-09 4" Curved Riser. **\$213.95**
56267-09 6" Curved Riser. **\$221.95**



I. CURVED PULL BACK FAT RISERS – 6" CHROME



I. CURVED PULL BACK FAT RISERS – 4" CHROME

*NOTE: Installation of some handlebars and risers may require a change in clutch and/or throttle cable and brake lines for some models. Handlebar height is regulated in many locations. Check local laws to ensure your motorcycle meets applicable regulations.

Notice: The prices appearing in this catalog are the manufacturer's suggested retail prices. Actual retail prices may vary.

544 CONTROLS

Handlebar Risers

A. SOFTAIL SLIM® PULL BACK RISER KIT*

Ideal for riders with a short reach or for those who prefer an upright riding position, these curved risers and the matching handlebar clamp are shaped to put the Original Equipment Softail Slim® handlebar closer to the rider. Designed for easy installation, these 4.5" high risers are compatible with the stock control cables for a low-cost conversion. Provides 1.75" of rise and 1.5" of additional pull back when compared to the stock FLS riser.

Fits most '12-'17 FLS and FLSS and '18-later FLSSL models. '15-'17 FLS and FLSS models equipped with ABS brakes require separate purchase of Brake Line P/N 41800300. Also fits most 1.0" diameter handlebars with separate purchase of additional components. Does not fit FXRST or Springer™ models. Riser height 4.5".

55900023	Chrome.	\$209.95
55900165	Gloss Black.	\$209.95

B. HANDLEBAR RISER KITS – CHROME*

These chrome-plated risers provide a comfortable riding position for those who like the shape, width and hand position of their current 1.0" handlebar, but wish it was closer. For an ergonomically friendly ride, these risers can be combined with a Harley-Davidson® Reach® forward-position seat and Profile® Low suspension components to reduce arm stretch and to plant the feet firmly on the ground. Finish off the look with a Harley-Davidson® decorative handlebar clamp kit.

Fits most 1.0" handlebars. Does not fit FXBB, FXBBS, FXBR, FXBRS, FXRST, FXST and Springer™ models or '21-later Touring and Trike models. Installation may require separate purchase of handlebar clamp. Installation also may affect fitment of handlebar-mounted instruments. See your dealer for details.

56066-82A	4.0" Curved Risers.	\$168.95
56063-82A	4.0" Straight Risers.	\$168.95
56266-09	6.0" Curved Risers.	\$173.95

C. POLYURETHANE HANDLEBAR RISER BUSHINGS

These Handlebar Riser Bushings replace the Original Equipment stacked rubber and zinc washer combination with a long-lasting polyurethane bushing and cover. These firm bushings provide a direct link between the bar and the front fork for a solid feel – and they reduce the softness you experience when a tall or wide handlebar is installed in Original Equipment vibration-isolating rubber mounts.

56298-03A \$54.95
Fits '83-later Touring models. Kit includes replacement bolts. Does not fit Trike models.

56165-03 \$48.95
Fits '97-'03 XL, '86-'17 Dyna® (except '08-'12 FXDB) and '86-'17 Softail® (except Springer™, FXS and FXSTD) models. '86-'93 FL Softail® models require use of '94-later riser bolts. Will not fit with Chrome Riser Cup Washer Kit P/N 56486-01.



A. SOFTAIL SLIM PULL BACK RISER KIT – CHROME



A. SOFTAIL SLIM PULL BACK RISER KIT – GLOSS BLACK



B. HANDLEBAR RISER KIT – CHROME STRAIGHT



B. HANDLEBAR RISER KIT – CHROME CURVED



C. POLYURETHANE HANDLEBAR RISER BUSHINGS



D. RISER CUP WASHER KIT – CHROME



E. HANDLEBAR CLAMP HARDWARE KIT – CHROME



F. LIVE TO RIDE HANDLEBAR CLAMP



G. CUSTOM HANDLEBAR CLAMPS

CONTROLS 545

Handlebar Risers

D. RISER CUP WASHER KIT – CHROME

Add a finishing touch to the riser on your bike. This kit includes two styled and chrome-plated washers that replace the standard metal washers below the handlebar risers. Replaces Original Equipment P/N 56159-73.

56486-01 \$30.95
Fits '97-'03 XL, '86-'17 Dyna® (except FXDB) and Softail® models (except Springer™, FXS and FXSTD). Does not fit with Polyurethane Handlebar Bushings P/N 56165-03.

E. HANDLEBAR CLAMP HARDWARE KIT – CHROME

Finish the show-winning look with brilliant chrome hardware. Manufactured to Original Equipment specifications, this kit replaces the zinc-plated exposed handlebar clamp bolts with chrome-plated socket head cap screws.

94451-05 \$11.95
Fits '05-'17 FLSTN, '94-'17 FLSTS, FLSTSB, FLSTSC, FXSTD, FXSTDSE, FXSTS and FXSTSB and '07-'08 FXSTSSE models.

94452-05 \$11.95
Fits '06 FXD, FXDB, FXDC and FXD35, '94-'06 FXDL, '94-'05 FXDWG, '99-'00 FXR2 and FXR3, '94-'17 FLST, FXST, FXSTB, FXSTC, '94-'08 FLSTC, '94-'06 FLSTF and '93-'96 FLSTN models.

94453-05 \$11.95
Fits '95-'13 XL (except XL883C, XL883N, XL1200C, XL1200L, XL1200N, XL1200V and XL1200X) and '94-'05 FXD, FXDC, FXDX, FXDXT and FXDS-CONV. models.

94454-05 \$11.95
Fits '96-'22 XL models (except for XL50, XL883, XL1200, XL1200S, XL1200R, '02-'12 XL883R and '05-'10 XL883L), '96-'06 XL883C and XL1200C, '07-'17 Dyna, '00 FXR4, '05-'06 FLSTFSE, '10-'12 FLTSE, '13-'17 FXSB, '16-'17 FXSE and '13-'14 FXSBSE models.

F. LIVE TO RIDE HANDLEBAR CLAMP

56178-92TA Gold. \$48.95
Fits '74-'06 XL, FX, FXR, FX Dyna and FX Softail models with stock and accessory 1.0" diameter handlebar (except '96-'06 XL883C and XL1200C and '99-'06 FXR).

G. CUSTOM HANDLEBAR CLAMPS

Fits '74-'06 XL, FX, FXR, FX Dyna and FX Softail models with stock and accessory 1.0" diameter handlebar (except '96-'06 XL883C and XL1200C and '99-'06 FXR).

56170-83TA	Classic Chrome.	\$33.95
56567-86B	Bar & Shield.	\$54.95

*NOTE: Installation of some handlebars and risers may require a change in clutch and/or throttle cable and brake lines for some models. Handlebar height is regulated in many locations. Check local laws to ensure your motorcycle meets applicable regulations.

*NOTE: Installation of some handlebars and risers may require a change in clutch and/or throttle cable and brake lines for some models. Handlebar height is regulated in many locations. Check local laws to ensure your motorcycle meets applicable regulations.

Model Family Fitment:

■ V-ROD	■ SPORTSTER	■ DYNA
■ SOFTAIL	■ TOURING	

Notice: The prices appearing in this catalog are the manufacturer's suggested retail prices. Actual retail prices may vary.

Notice: The prices appearing in this catalog are the manufacturer's suggested retail prices. Actual retail prices may vary.



Road Glide® Special - Harley-Davidson® Audio powered by Rockford Fosgate® - Stage II Fairing Speakers

HARLEY-DAVIDSON®

AUDIO & GAUGES

Measure your next journey in songs, not miles. With a Harley-Davidson sound system, you'll lose yourself in your own soundtrack. And, with Bluetooth®-enabled wireless communication, you can stay connected, even in the middle of nowhere.

HARLEY-DAVIDSON® AUDIO POWERED BY ROCKFORD FOSGATE®

Get ready to be blown away by a sonic storm. Harley-Davidson® Audio powered by Rockford Fosgate® is designed to be the new standard of motorcycle audio performance and customization. Harley-Davidson and Rockford Fosgate have worked together to create the highest performing, most advanced audio system riders have ever experienced. This is truly Legendary Sound from two legendary brands.

Stage I Speakers

Amplify your audio experience with Harley-Davidson® Audio powered by Rockford Fosgate® Stage I speakers. These high-performance two-way speakers feature a durable injection molded woofer and a separate bridge-mounted tweeter. Each speaker is rated to handle up to 75 watts of power, and with two amplifiers up to eight speakers can be installed in a single system. Designed to fit perfectly in the Original Equipment speaker housing. These speakers deliver a significant upgrade in sound quality and power over the Original Equipment components. Harley-Davidson® audio powered by Rockford Fosgate® speakers feature a one-year warranty. Complete kit includes Left and Right speakers and grilles.

Stage I/II Features:

R-Tune

Equalization is specific to the motorcycle environment, designed from the ground up to be stronger and louder, to overcome road rumble and wind noise. Left and right speakers are designed to project sound directly at the rider for an enhanced audio experience.

BME (Bass Management Enhancement)

Designed to produce more bass, no matter the volume. The active amplifier DSP continually adapts to speed and road noise and maximizes the speakers' bass output to create powerful bass at any volume or speed.

IDHS™ (Inductive Damping Heat Sink)

The speaker fins push heat away from the voice coils to reduce speaker temperature and distortion to produce the clearest-possible audio.

ICC+

The Integrated Concealed Crossover boasts a hyper-efficient design and produces the clarity and output usually only found in traditional component speaker set-ups, plus the design allows for a quicker install.

Stage II Speakers

Step up to the ultimate motorcycle audio experience. Harley-Davidson® Audio powered by Rockford Fosgate® Stage II speakers deliver ultra-clear highs, super clean mids, and ground thumping bass. These amplified three-way speakers feature a durable injection molded woofer and a separate bridge-mounted midrange and tweeter speakers. Each speaker unit is rated to handle up to 150 watts of power and designed to deliver outrageous volume with less distortion for amazing sound even at highway speeds. With two amplifiers up to eight Stage II speakers can be installed in a single system. Designed to fit perfectly in the Original Equipment speaker housing, each kit includes Left and Right speakers and custom grilles with a bright aluminum badge.

The Harley-Davidson® powered by Rockford Fosgate® App

Install and fine-tune the system yourself. Smart-Install makes initial installation and upgrades incredibly fast and easy. The Harley-Davidson® powered by Rockford Fosgate® App even adapts for each new speaker added to the audio system and tailors the audio experience automatically.

M-DEQ™ (Motorcycle Dynamic EQ)

Our smart amplifier adaptively changes the EQ points in real time, meaning the tune changes to ensure incredible sound quality no matter the motorcycle speed or riding conditions.

Full Range Class-D Technology

More power and less electrical fatigue. These high-efficiency amplifiers produce class leading power and don't over-draw on the motorcycle electrical system.

Bridge Mounted Design

The offset speaker design eliminates acoustic reflection and maximizes audio output. The specific left and right Tweeters are aligned to the motorcycle rider's position -- sound is always directed for an optimal on-road audio experience.



A. HARLEY-DAVIDSON AUDIO POWERED BY ROCKFORD FOSGATE STAGE I FAIRING SPEAKERS – ROAD GLIDE



A. HARLEY-DAVIDSON AUDIO POWERED BY ROCKFORD FOSGATE STAGE I FAIRING SPEAKERS – BATWING



B. HARLEY-DAVIDSON AUDIO POWERED BY ROCKFORD FOSGATE STAGE II FAIRING SPEAKERS – ROAD GLIDE



B. HARLEY-DAVIDSON AUDIO POWERED BY ROCKFORD FOSGATE STAGE II FAIRING SPEAKERS – BATWING



C. HARLEY-DAVIDSON AUDIO POWERED BY ROCKFORD FOSGATE – FAIRING SPEAKER INSTALLATION KIT

AUDIO & GAUGES 549

Rockford Fosgate® Audio

A. HARLEY-DAVIDSON® AUDIO POWERED BY ROCKFORD FOSGATE® – STAGE I FAIRING SPEAKERS

Upgrade Original Equipment Batwing or Road Glide fairing speakers for more volume and improved sound quality. Vibration-tested 6.5" waterproof 4 ohm speakers feature injection molded woofer cones with a high-flux Neodymium magnet and bridge-mounted 25mm tweeter. Harley-Davidson powered by Rockford Fosgate® speakers feature a one-year warranty. Complete kit includes retainers, hardware, left and right speakers and grilles.

76000982 Road Glide® Fairing **\$263.95**
Fits '14-later Road Glide models (except FLTRXSE). Requires purchase of Fairing Speaker Install Kit P/N 76000992, Primary Amplifier P/N 76000997 and appropriate Primary Amp Install Kit. FLTRUSE requires separate purchase of CVO model Wire Harness P/N 76001100.

76000980 Batwing Fairing **\$263.95**
Fits '14-later Electra Glide®, Street Glide®, Ultra Limited and Tri Glide® models (except FLHXSE). Requires purchase of Fairing Speaker Install Kit P/N 76000992, Primary Amplifier P/N 76000997 and appropriate Primary Amp Install Kit. FLHTKSE requires separate purchase of CVO™ model Wire Harness P/N 76001100.

B. HARLEY-DAVIDSON® AUDIO POWERED BY ROCKFORD FOSGATE® – STAGE II FAIRING SPEAKERS

Upgrade Original Equipment Batwing or Road Glide fairing speakers for more volume and improved sound quality. Vibration-tested 6.5" waterproof 2 ohm speakers feature injection molded woofer cones with a high-flux Neodymium magnet and 20mm Tweeter and 30mm Midrange speaker. Harley-Davidson powered by Rockford Fosgate® feature a one-year warranty. Complete kit includes retainers, hardware, Left and Right speakers and grilles.

76000983 Road Glide® Fairing **\$399.95**
Fits '14-later Road Glide models (except FLTRXSE). Requires purchase of Fairing Speaker Install Kit P/N 76000992, Primary Amplifier P/N 76000997 and appropriate Primary Amp Install Kit. FLTRUSE requires separate purchase of CVO model Wire Harness P/N 76001100.

76000981 Batwing Fairing. **\$399.95**
Fits '14-later Electra Glide, Street Glide, Ultra Limited and Tri Glide models (except FLHXSE). Requires purchase of Fairing Speaker Install Kit P/N 76000992, Primary Amplifier P/N 76000997 and appropriate Primary Amp Install Kit. FLHTKSE requires separate purchase of CVO model Wire Harness P/N 76001100.

C. HARLEY-DAVIDSON® AUDIO POWERED BY ROCKFORD FOSGATE® – FAIRING SPEAKER INSTALLATION KIT

Kit includes wiring harnesses required to install Harley-Davidson® Audio powered by Rockford Fosgate® Batwing or Road Glide® Fairing Speakers. Harley-Davidson® Audio powered by Rockford Fosgate® speakers are sold separately.

76000992 **\$43.95**
Fits '14-later Touring and Tri Glide models (except CVO™ model). For use with Harley-Davidson® Audio powered by Rockford Fosgate® Stage I or Stage II Fairing Speaker Kits.

Model Family Fitment:

V-ROD
 SPORTSTER
 DYNA
 SOFTAIL
 TOURING

Notice: The prices appearing in this catalog are the manufacturer's suggested retail prices. Actual retail prices may vary.

550 AUDIO & GAUGES

Rockford Fosgate® Audio

A. HARLEY-DAVIDSON® AUDIO POWERED BY ROCKFORD FOSGATE® – STAGE I SADDLEBAGS SPEAKERS

Turn your motorcycle into a concert hall. Speakers mounted in saddlebag lids surround rider and passenger with sound and increase the over-all volume of the audio system. Vibration-tested 5x7" waterproof 4 ohm speakers feature injection molded woofer cones with a high-flux Neodymium magnet and bridge-mounted 25mm tweeter. Harley-Davidson® powered by Rockford Fosgate® speakers feature a one-year warranty. Complete kit includes left and right speakers and grilles.

76000986 **\$273.95**

Fits '14-later Touring models (except '14-'16 FLHXSE and FLTRXSE). Requires separate purchase of Saddlebag Speaker Install Kit P/N 76000979 and appropriate Amplifier and Amplifier Install Kit. FLHTKSE and FLTRUSE require separate purchase of CVO™ model Wire Harness P/N 76001100.

B. HARLEY-DAVIDSON® AUDIO POWERED BY ROCKFORD FOSGATE® – STAGE II SADDLEBAGS SPEAKERS

Turn your motorcycle into a concert hall. Speakers mounted in saddlebag lids surround rider and passenger with sound and increase the over-all volume of the audio system. Vibration-tested 5x7" waterproof 2 ohm speakers feature injection molded woofer cones with a high-flux Neodymium magnet and 20mm tweeter and 30mm midrange speakers. Harley-Davidson® audio powered by Rockford Fosgate® feature a one-year warranty. Complete kit includes hardware, Left and Right speakers and grilles.

76000987 **\$399.95**

Fits '14-later Touring models (except '14-'16 FLHTKSE and '15-'20 FLHXSE and FLTRXSE models). Requires separate purchase of Saddlebag Speaker Install Kit P/N 76000979 and appropriate Amplifier and Amplifier Install Kit. '17-'21 FLHTKSE and '15-later FLTRUSE require separate purchase of CVO Wire Harness P/N 76001100.

C. HARLEY-DAVIDSON® AUDIO POWERED BY ROCKFORD FOSGATE® – SADDLEBAG SPEAKER INSTALLATION KIT

Kit includes all the hardware and wiring harnesses required to install a Harley-Davidson® Audio powered by Rockford Fosgate® Saddlebag Speaker Kit. Harley-Davidson® audio powered by Rockford Fosgate® speakers are sold separately. Requires separate purchase of Left and Right Color Matched Saddlebag Speaker Lids.

76000979 **\$74.95**

Fits '14-later Touring models (except FLHXSE and FLTRXSE). For use with Harley-Davidson® Audio powered by Rockford Fosgate® Stage I or Stage II Saddlebag Speaker Kits. CVO™ models separate of CVO Wire Harness P/N 76001100.



HARLEY-DAVIDSON AUDIO POWERED BY ROCKFORD FOSGATE SADDLEBAGS SPEAKERS – STAGE II SHOWN



A. HARLEY-DAVIDSON AUDIO POWERED BY ROCKFORD FOSGATE – STAGE I SADDLEBAGS SPEAKERS



B. HARLEY-DAVIDSON AUDIO POWERED BY ROCKFORD FOSGATE – STAGE II SADDLEBAGS SPEAKERS



C. HARLEY-DAVIDSON AUDIO POWERED BY ROCKFORD FOSGATE – SADDLEBAG SPEAKER INSTALLATION KIT



HARLEY-DAVIDSON AUDIO POWERED BY ROCKFORD FOSGATE TOUR-PAK / AIR COOLED FAIRING LOWER SPEAKERS – STAGE II SHOWN ON TOUR-PAK



D. HARLEY-DAVIDSON AUDIO POWERED BY ROCKFORD FOSGATE – STAGE I TOUR-PAK / AIR-COOLED FAIRING LOWER SPEAKERS



E. HARLEY-DAVIDSON AUDIO POWERED BY ROCKFORD FOSGATE – STAGE II TOUR-PAK / AIR-COOLED FAIRING LOWER SPEAKERS



F. HARLEY-DAVIDSON AUDIO POWERED BY ROCKFORD FOSGATE – TOUR-PAK SPEAKER INSTALLATION KIT



G. HARLEY-DAVIDSON AUDIO POWERED BY ROCKFORD FOSGATE – AIR-COOLED FAIRING LOWER SPEAKER INSTALLATION KIT

AUDIO & GAUGES 551

Rockford Fosgate® Audio

D. HARLEY-DAVIDSON® AUDIO POWERED BY ROCKFORD FOSGATE® – STAGE I TOUR-PAK® / AIR COOLED FAIRING LOWER SPEAKERS

Upgrade Original Equipment Tour-Pak® carrier speakers for more volume and improved sound quality. Adding fairing lower speakers to your current two-speaker or four-speaker system increases the available sound pressure level, permitting higher listening volume, lower distortion, and improved clarity at highway speeds. Vibration-tested 6.5" waterproof 4 ohm speakers feature injection molded woofer cones with a high-flux Neodymium magnet and bridge-mounted 25mm tweeter. Harley-Davidson powered by Rockford Fosgate® speakers feature a one-year warranty. Complete kit includes left and right speakers and grilles.

76000984 **\$263.95**

Fits '14-later Touring models (except CVO™ models) equipped with a Tour-Pak carrier or Air-Cooled Fairing Lower. Also Fits '14-later FLHTCUTG models equipped with a Tour-Pak. Requires separate purchase of appropriate Speaker Install Kit, Amplifier, and Amplifier Install Kit. FLHTKSE and FLTRUSE require separate purchase of CVO Wire Harness P/N 76001100 when installing Tour-Pak Speakers.

E. HARLEY-DAVIDSON® AUDIO POWERED BY ROCKFORD FOSGATE® – STAGE II TOUR-PAK® / AIR-COOLED FAIRING LOWER SPEAKERS

Upgrade Original Equipment Tour-Pak luggage carrier speakers for more volume and improved sound quality. Adding fairing lower speakers to your current two-speaker or four-speaker system increases the available sound pressure level, permitting higher listening volume, lower distortion, and improved clarity at highway speeds. Vibration-tested 6.5" waterproof 2 ohm speakers feature injection molded woofer cones with a high-flux Neodymium magnet and 20mm tweeter and 30mm Midrange speaker. Harley-Davidson powered by Rockford Fosgate® feature a one-year warranty. Complete kit includes left and right speakers and grilles.

76000985 **\$399.95**

Fits '14-later Touring models (except '15-'20 FLHXSE and '18-'20 FLTRXSE) equipped with a Tour-Pak or Air-Cooled Fairing Lower. Also Fits '14-later Tri-Glide® models equipped with a Tour-Pak carrier. Requires separate purchase of appropriate Speaker Install Kit, Amplifier, and Amplifier Install Kit. '14-'21 FLHTKSE, '15-'16 FLTRUSE and '21 FLHTCUTGSE require separate purchase of CVO Wire Harness P/N 76001100 when installing Tour-Pak Speakers. Air-Cooled Fairing Lower also require separate purchase of Color Matched Fairing Lower Speaker Front Enclosure P/N 57100233.

F. HARLEY-DAVIDSON® AUDIO POWERED BY ROCKFORD FOSGATE® - TOUR PAK SPEAKER INSTALLATION KIT

Kit includes wiring harnesses required to install Harley-Davidson® Audio powered by Rockford Fosgate® Tour Pak luggage carrier speakers. Harley-Davidson® Audio powered by Rockford Fosgate® speakers are sold separately.

76000977 **\$107.95**

Fits '14-later Touring and Tri Glide models. For use with Harley-Davidson® Audio powered by Rockford Fosgate® Stage I or Stage II Tour-Pak Speaker Kits. FLHTKSE and FLTRUSE models requires separate purchase of P/N CVO™ model Wire Harness 76001100.

G. HARLEY-DAVIDSON® AUDIO POWERED BY ROCKFORD FOSGATE® - AIR-COOLED FAIRING LOWER SPEAKER INSTALLATION KIT

Kit includes speaker enclosures and all hardware and wiring harnesses required to install Harley-Davidson® Audio powered by Rockford Fosgate® Air-Cooled Fairing Lower Speakers. Harley-Davidson® Audio powered by Rockford Fosgate® speakers are sold separately.

76000978 **\$127.95**

Fits '17-later Touring (except CVO models). For use with Harley-Davidson® Audio powered by Rockford Fosgate® Stage I or Stage II Air-Cooled Fairing Lower Speakers Kits.

Model Family Fitment:

- V-ROD
- SPORTSTER
- DYNA
- SOFTAIL
- TOURING

Notice: The prices appearing in this catalog are the manufacturer's suggested retail prices. Actual retail prices may vary.

Notice: The prices appearing in this catalog are the manufacturer's suggested retail prices. Actual retail prices may vary.

552 AUDIO & GAUGES

Rockford Fosgate® Audio

A. HARLEY-DAVIDSON® AUDIO POWERED BY ROCKFORD FOSGATE® – STAGE I TWIN-COOLED™ MODELS FAIRING LOWER SPEAKERS

Adding fairing lower speakers to your current two-speaker or four-speaker system increases the available sound pressure level, permitting higher listening volume, lower distortion, and improved clarity at highway speeds. Vibration-tested 4.75" waterproof 8 ohm speakers feature injection molded woofer cones with a high-flux Neodymium magnet and bridge-mounted 20mm tweeter. Harley-Davidson powered by Rockford Fosgate® speakers feature a one-year warranty. Complete kit includes sub-assembly, hardware, left and right speakers and grilles.

76000988 \$263.95

Fits '14-later FLHTK, FLTRK and FLTRU. Also fits '17-later FLHTKSE and FLTRUSE. Requires separate purchase of Twin-Cooled Fairing Lower Speaker Install Kit P/N 76000991 and appropriate Amplifier and Amplifier Install Kit. FLHTKSE and FLTRUSE require purchase of CVO™ models Wire Harness P/N 76001100.



A. HARLEY-DAVIDSON AUDIO POWERED BY ROCKFORD FOSGATE TWIN-COOLED FAIRING LOWER SPEAKERS – STAGE II SHOWN

B. HARLEY-DAVIDSON® AUDIO POWERED BY ROCKFORD FOSGATE® – STAGE II TWIN-COOLED FAIRING LOWER SPEAKERS

Adding fairing lower speakers to your current two-speaker or four-speaker system increases the available sound pressure level, permitting higher listening volume, lower distortion, and improved clarity at highway speeds. Vibration-tested 4.7" waterproof 4 ohm speakers feature injection molded woofer cones with a high-flux Neodymium magnet and a 25mm tweeter. Harley-Davidson powered by Rockford Fosgate® feature a one-year warranty. Complete kit includes sub-assembly, hardware, left and right speakers and grilles.

76000989 \$399.95 Fits '14-later FLHTK, FLTRK and FLTRU models. Also fits '17-later FLHTKSE and FLTRUSE models with separate purchase of Twin-Cooled™ models with Fairing Lower Speaker Install Kit P/N 76000991 and appropriate Amplifier and Amplifier Install Kit. FLHTKSE and FLTRUSE require purchase of CVO model Wire Harness P/N 76001100.



B. HARLEY-DAVIDSON AUDIO POWERED BY ROCKFORD FOSGATE TWIN-COOLED FAIRING LOWER SPEAKERS – STAGE I AND STAGE II SHOWN

C. HARLEY-DAVIDSON® AUDIO POWERED BY ROCKFORD FOSGATE® – TWIN-COOLED™ MODELS WITH LOWER SPEAKER INSTALLATION KIT

Kit includes speaker enclosures and all hardware and wiring harnesses required to install Harley-Davidson® Audio powered by Rockford Fosgate® Twin-Cooled™ models with Fairing Lower Speakers. Harley-Davidson® Audio powered by Rockford Fosgate® speakers are sold separately.

76000991 \$33.95

Fits '14-later FLHTK, FLTRK, FLTRU, FLTRUSE and '17-later FLHTKSE models. Does not fit '14-'16 FLHTKSE, FLHXSE and FLTRXSE. For use with Harley-Davidson® Audio powered by Rockford Fosgate® Stage I or Stage II Twin-Cooled Fairing Lower Speaker Kits. FLHTKSE and FLTRUSE require purchase of CVO Wire Harness P/N 76001100.



C. HARLEY-DAVIDSON AUDIO POWERED BY ROCKFORD FOSGATE –TWIN-COOLED™ LOWER SPEAKER INSTALLATION KIT

D. HARLEY-DAVIDSON® AUDIO POWERED BY ROCKFORD FOSGATE® – CVO MODEL WIRE HARNESS

Use this Harness Kit to upgrade certain CVO model motorcycles to a Harley-Davidson® Audio powered by Rockford Fosgate® system. Harley-Davidson® Audio powered by Rockford Fosgate® speakers are sold separately.

76001100 \$107.95

Fits '14-'21 FLHTKSE and '15-'16 FLTRUSE models. Does not fit with Fairing Lower Speaker on '14-'16 FLHTKSE.



D. HARLEY-DAVIDSON AUDIO POWERED BY ROCKFORD FOSGATE – CVO MODEL WIRE HARNESS

Notice: The prices appearing in this catalog are the manufacturer's suggested retail prices. Actual retail prices may vary.

AUDIO & GAUGES 553

Rockford Fosgate® Audio

HARLEY-DAVIDSON® AUDIO POWERED BY ROCKFORD FOSGATE® AMPLIFIER

Powerful, intelligent amplifier technology engineered to perform in the demanding motorcycle environment. This new, compact amplifier is easy to install in the motorcycle saddlebag. R-Tune: Equalization is specific to the motorcycle environment, designed from the ground up to be stronger and louder, to overcome road rumble and wind noise. Left and right speakers are designed to project sound directly at the rider for an enhanced audio experience. M-DEQ™ (Motorcycle Dynamic EQ): Our smart amplifier adaptively changes the EQ points in real time, meaning the tune changes to ensure incredible sound quality no matter the motorcycle speed or riding conditions. BME (Bass Management Enhancement): Designed to produce more bass, no matter the volume. The active amplifier DSP continually adapts to speed and road noise and maximizes the speakers' bass output to create powerful bass at any volume or speed. Computer Controlled Digital Signal Processing: Smart control, agile configurations. This intelligent amplifier continuously adapts to your speaker set-up. When you step up to the next audio stage or add additional speakers, the amplifier adjusts signal and output and is ready to deliver the sound quality and SPL you demand. Full Range Class-D Technology: More power and less electrical fatigue. These high-efficiency amplifiers produce class leading power and don't over-draw on the motorcycle electrical system. Ridiculously Rugged: Built stronger and ready to go anywhere. This amplifier was designed and tested over 80 hours to perform in the harshest conditions, no matter the heat or environment. So, anywhere you and your bike can go, our amplifiers can too. Rated Power: 50 watts per channel x 4 @ 4ohms; 100 watts per channel x 4 @ 2ohms Dimensions: 8.13" x 5.39" x 2.01"



E. HARLEY-DAVIDSON AUDIO POWERED BY ROCKFORD FOSGATE – AMPLIFIER 400W 4 CHANNEL W/ DSP (PRIMARY)

E. HARLEY-DAVIDSON® AUDIO POWERED BY ROCKFORD FOSGATE® – PRIMARY AMPLIFIER WITH DSP

The primary amplifier for any Harley-Davidson® Audio powered by Rockford Fosgate® two-speaker or four-speaker system.

76000997 \$568.95

Fits '14-later Touring (except FLXHSE and FLTRXSE) and Tri-Glide models. Requires separate purchase of appropriate Amp Installation Kit. Required for the installation of a set of 2 or 4 total Harley-Davidson® Audio powered by Rockford Fosgate® Stage I or Stage II Speaker Kits. Does not fit with Saddlebag Guard Rails.

F. HARLEY-DAVIDSON® AUDIO POWERED BY ROCKFORD FOSGATE® – SECONDARY AMPLIFIER

The secondary amplifier required for any Harley-Davidson® Audio powered by Rockford Fosgate® six-speaker or eight-speaker system.

76000990 \$568.95

Fits '14-later Touring models (except '15-'20 FLHXSE and '18-'20 FLTRXSE). Does not fit Trike models. Requires separate purchase of Secondary Amp Install Kit P/N 76000975. Required for the installation of 6 or 8 total Harley-Davidson® Audio powered by Rockford Fosgate® Stage 1 or Stage 2 Speaker Kits. Must be installed as a second Amplifier with Primary Amplifier Kit P/N 76000991. '22 FLTRKSE require separate purchase of P/N's (1) 69200272 2-Pin Connector, (2) 72169-07 Terminal Pin and (2) 72168-07 Terminal Socket. Does not fit with Saddlebag Guard Rails.



F. HARLEY-DAVIDSON AUDIO POWERED BY ROCKFORD FOSGATE – AMPLIFIER 400W 4-CHANNEL (SECONDARY)

*NOTE: Harley-Davidson Audio powered by Rockford Fosgate products are garage ready in most cases. However in some cases, amplifiers may need to be reflashed at a dealership in order to ensure the software is the latest and greatest. The Harley-Davidson Audio powered by Rockford Fosgate mobile app will alert you regarding this necessary dealership reflash. Vehicles with Boom! Box 4.3 and Boom! Box 6.5 GT Radios require a dealer Digital Technician II flash. Vehicles with Boom! Box GTS radios require the latest software from www.harley-davidson.com.

Model Family Fitment:

V-ROD
 SPORTSTER
 DYNA
 SOFTAIL
 TOURING

Notice: The prices appearing in this catalog are the manufacturer's suggested retail prices. Actual retail prices may vary.

554 AUDIO & GAUGES

Rockford Fosgate® Audio

A. HARLEY-DAVIDSON® AUDIO POWERED BY ROCKFORD FOSGATE® – PRIMARY AMPLIFIER INSTALLATION KIT

Kit includes the hardware and wiring harnesses required to install a Harley-Davidson® Audio powered by Rockford Fosgate® Primary Amplifier. Harley-Davidson® Audio powered by Rockford Fosgate® speakers are sold separately.

76000974 **\$220.95**

Fits '17-later Touring models (except FLHXSE and FLTRXSE and '22-later FLHTKSE and FLTRKSE)). For use with Primary Amplifier Kit P/N 76000997. FLHTKSE and FLTRUSE require separate of Harness Kit P/N 76001100.

76001045 **\$232.95**

Fits '14-'16 Touring models (except FLHXSE and FLTRXSE). For use with Harley-Davidson® Audio powered by Rockford Fosgate® Amplifier Kit P/N 76000997. FLHTKSE and FLTRUSE require separate purchase of CVO™ model Wire Harness P/N 76001100.

B. HARLEY-DAVIDSON® AUDIO POWERED BY ROCKFORD FOSGATE® – SECONDARY AMPLIFIER INSTALLATION KIT

Kit includes the hardware and wiring harnesses required to install a Harley-Davidson® Audio powered by Rockford Fosgate® Secondary Amplifier. Harley-Davidson® Audio powered by Rockford Fosgate® speakers are sold separately.

76000975 **\$178.95**

Fits '14-later Touring models (except '15-'20 FLHXSE and '18-'20 FLTRXSE). For use with Secondary Amplifier Kit P/N 76000990. FLHTKSE and FLTRUSE require separate purchase of CVO Wire Harness P/N 76001100. '22 FLTRKSE require separate purchase of P/N's (1) 69200272 2-Pin Connector, (2) 72169-07 Terminal Pin and (2) 72168-07 Terminal Socket. Does not fit with Saddlebag Guard Rails.

C. HARLEY-DAVIDSON® AUDIO POWERED BY ROCKFORD FOSGATE® – TRIKE AMPLIFIER INSTALLATION KIT

Kit includes the hardware and wiring harnesses required to install a Harley-Davidson® Audio powered by Rockford Fosgate® Primary Amplifier in a Trike model. Harley-Davidson® Audio powered by Rockford Fosgate® speakers are sold separately.

76000976 **\$232.95**

Fits '17-later FLHTCUTG and '17-'21 FLHTCUTGSE models. For use with Harley-Davidson® Audio powered by Rockford Fosgate® Amplifier Kit P/N 76000997. FLHTCUTGSE models requires separate purchase of CVO Wire Harness P/N 76001100. Stock on '22 FLHTCUTGSE models.

76001046 **\$232.95**

Fits '14-'16 Trike (except Freewheeler®) models. For use with Harley-Davidson® Audio powered by Rockford Fosgate® Amplifier Kit P/N 76000997.



A. HARLEY-DAVIDSON AUDIO POWERED BY ROCKFORD FOSGATE – PRIMARY AMPLIFIER INSTALLATION KIT



B. HARLEY-DAVIDSON AUDIO POWERED BY ROCKFORD FOSGATE – SECONDARY AMPLIFIER INSTALLATION KIT



C. HARLEY-DAVIDSON AUDIO POWERED BY ROCKFORD FOSGATE – TRIKE AMPLIFIER INSTALLATION KIT



D. HARLEY-DAVIDSON® AUDIO POWERED BY ROCKFORD FOSGATE SUBWOOFER KIT – PRIMARY



D. HARLEY-DAVIDSON AUDIO POWERED BY ROCKFORD FOSGATE SUBWOOFER KIT – PRIMARY



E. HARLEY-DAVIDSON AUDIO POWERED BY ROCKFORD FOSGATE SUBWOOFER KIT – SECONDARY

AUDIO & GAUGES 555

Audio – Subwoofers

HARLEY-DAVIDSON® AUDIO POWERED BY ROCKFORD FOSGATE® SUBWOOFER KIT

The deep bass will turn heads when you roll up playing your Harley-Davidson® Audio powered by Rockford Fosgate® Subwoofer Kit. Designed for 2014-later Touring bikes equipped with Harley-Davidson® Audio powered by Rockford Fosgate® audio, these plug-and-play 10-inch subwoofers enable heart-thumping bass while cruising around the city streets or out on the open road. Can be installed as a single subwoofer or a dual subwoofer set.

- Single or dual woofer flexibility provides as much big bass sound as you want
- Entire subwoofer enclosure may be removed without tools when space is needed in the saddlebags.
- Included saddlebag cover panel protects saddlebag contents when subwoofer is removed
- Plug-and-play design is easy to install and to remove when desired
- Harley-Davidson® Audio powered by Rockford Fosgate® branding showcases the quality of this subwoofer system
- Power Lock cut-out enables installation in CVO™ models with power saddlebag locks and maintains that security

D. HARLEY-DAVIDSON® AUDIO POWERED BY ROCKFORD FOSGATE® SUBWOOFER KIT – PRIMARY

76001163 Primary **\$683.95**

Fits '14-later Touring models in the right-side saddlebag when equipped with two or four total speakers on a Harley-Davidson® Audio powered by Rockford Fosgate® audio system. '21-'22 FLHXSE, FLTRXSE and '22 FLTRKSE requires separate purchase of Bluetooth Dongle P/N 41000771, Secondary Amp Kit P/N 76000990 and Secondary Amp Install Kit P/N 76000975. Does not fit Trike or Road King models.

E. HARLEY-DAVIDSON® AUDIO POWERED BY ROCKFORD FOSGATE® SUBWOOFER KIT – SECONDARY

76001164 Secondary **\$683.95**

Fits '14-later Touring models in the left-side saddlebag when equipped with two or four total speakers on a Harley-Davidson® Audio powered by Rockford Fosgate® audio system. Does not fit Trike or Road King models. Installation of second subwoofer kit requires separate purchase of Harley-Davidson® Audio powered by Rockford Fosgate® Amplifier P/N 76000990.

Note: Installation of just the primary subwoofer with one set of speakers requires one primary amplifier P/N 76000997 to power the system. Installation of the primary subwoofer with four speakers, or with the the primary and secondary subwoofer with either two or four speakers requires the primary amplifier P/N 76000997 and secondary amplifier P/N 76000990 to power the system..

Model Family Fitment:

- V-ROD
- SPORTSTER
- DYNA
- SOFTAIL
- TOURING

Notice: The prices appearing in this catalog are the manufacturer's suggested retail prices. Actual retail prices may vary.

Notice: The prices appearing in this catalog are the manufacturer's suggested retail prices. Actual retail prices may vary.

556 AUDIO & GAUGES

Rockford Fosgate® Audio with Bluetooth

A. HARLEY-DAVIDSON® AUDIO POWERED BY ROCKFORD FOSGATE® - AMPLIFIER WITH DSP FOR ROAD KING® MODELS

Here's the foundation of the ultimate motorcycle audio experience for Harley-Davidson® Road King® motorcycles. Powerful, intelligent amplifier with digital signal processing (DSP) technology developed jointly by Harley-Davidson and Rockford Fosgate® is engineered to perform in the demanding motorcycle environment. Connects to your mobile device via Bluetooth to play stored or streaming audio through Harley-Davidson® Audio powered by Rockford Fosgate® speakers (sold separately) and turns your Road King® motorcycle into a concert hall.

- Compact amplifier is easy to install in the motorcycle saddlebag
- Power two Harley-Davidson Audio powered by Rockford Fosgate® Stage II speakers (sold separately) installed in saddlebag lids, fairing lowers, or King Tour-Pak® Luggage
- 125 watts x 2 per channel @ 4ohms; 125 x 2 watts per channel @ 2ohms
- Requires separate purchase of Amplifier Installation Kit P/N 76001113, a Harley-Davidson Audio powered by Rockford Fosgate® Stage II speaker kit, and the applicable installation kit specific to the speaker kit
- Dimensions: 8.13" x 5.39" x 2.01"
- Learn More about the Harley-Davidson® Audio powered by Rockford Fosgate® products at Harley-Davidson.com

76001074 \$473.95
Fits '14-later Road King® models (except FLHRC). Requires separate purchase of installation kit P/N 76001113. Required for the installation of one Harley-Davidson® Audio powered by Rockford Fosgate® Stage II speaker kit. Does not fit with Saddlebag Guard Rails.

B. ROAD KING® AMPLIFIER INSTALLATION KIT

Includes components required for installation of Harley-Davidson® Audio powered by Rockford Fosgate® Amplifier P/N 76001074 in a Road King® model.

76001113 \$263.95
Fits 14-later Road King models equipped with Harley-Davidson® Audio powered by Rockford Fosgate® - Amplifier with DSP P/N 76001074.

C. HARLEY-DAVIDSON® AUDIO POWERED BY ROCKFORD FOSGATE® - INNER FAIRING AUDIO KIT

A high-performance motorcycle deserves high-output audio. This kit was designed alongside the Low Rider® ST for outstanding performance and an ideal fit within the fairing. A powerful, intelligent amplifier with digital signal processing (DSP) technology developed jointly by Harley-Davidson and Rockford Fosgate® is engineered to perform in the demanding motorcycle environment. Connects to your mobile device via Bluetooth to play stored or streaming audio through a pair of built-in two-way speakers.

- Marine grade two-way tweeters include a pair of 5.25" woofers and two remote tweeters aimed at the rider's ears for great audio performance
- Lightweight design has minimal impact vehicle dynamics and performance
- Plug-and play installation. One assembly includes the amplifier, speakers and housing, which replaces the original equipment inner fairing.
- Two simple wiring connections power the unit
- Uses Bluetooth 4.2 for a strong wireless connection to most devices with minimal compression for outstanding sound quality
- Connectivity with the Harley-Davidson® Audio powered by Rockford Fosgate® mobile app offers unique features like Automatic Volume Control (AVC), adjustable 7-Band EQ, and step by step system configurator.
- Compact amplifier mounts within the fairing. 250 watts of amplifier power (125 x 2 @ 4ohms / 125 x 2 @ 2ohms) for crisp, clear sound quality at any volume. Overcomes bike, environment, and helmet sound-limiting variables at all speeds

76200037 \$1,050.95
Fits '22-later FXLRST models. Original Equipment on FXRST models.



A. HARLEY-DAVIDSON AUDIO POWERED BY ROCKFORD FOSGATE – AMPLIFIER WITH DSP FOR ROAD KING® MODELS (SHOWN WITH SADDLEBAG SPEAKERS)



A. HARLEY-DAVIDSON AUDIO POWERED BY ROCKFORD FOSGATE – AMPLIFIER WITH DSP FOR ROAD KING MODELS



B. ROAD KING® AMPLIFIER INSTALLATION KIT



C. HARLEY-DAVIDSON® AUDIO POWERED BY ROCKFORD FOSGATE® – INNER FAIRING AUDIO KIT

Harley-Davidson® Audio powered by Rockford Fosgate® FITMENT GUIDE



AUDIO & GAUGES 557

Rockford Fosgate® Audio

STREET GLIDE®/STREET GLIDE SPECIAL MODELS ('14-LATER)

	STAGE 1		STAGE 2	
	PART NUMBER	DESCRIPTION	PART NUMBER	DESCRIPTION
FAIRING	76000980	Stage 1 Batwing Fairing Speakers	76000981	Stage 2 Batwing Fairing Speakers
	76000992	Fairing Speaker Installation Kit	76000992	Fairing Speaker Installation Kit
SADDLEBAG	76000986	Stage 1 Saddlebags Speakers	76000987	Stage 2 Saddlebags Speakers
	76000979	Saddlebag Speaker Installation Kit	76000979	Saddlebag Speaker Installation Kit
	<i>Requires separate purchase of color-matched saddlebag speaker lids</i>		<i>Requires separate purchase of color-matched saddlebag speaker lids</i>	
FAIRING LOWER	76000984	Stage 1 Tour-Pak / Air Cooled Lower Speakers	76000985	Stage 2 Tour-Pak / Air-Cooled Lower Speakers
	76000978	Air-Cooled Lower Speaker Installation Kit	76000978	Air-Cooled Lower Speaker Installation Kit
	<i>Requires separate purchase of color-matched fairing lowers</i>		<i>Requires separate purchase of color-matched fairing lowers</i>	
TOUR-PAK® <i>Luggage Carrier</i>	76000984	Stage 1 Tour-Pak / Air Cooled Lower Speakers	76000985	Stage 2 Tour-Pak / Air-Cooled Lower Speakers
	76000977	Tour-Pak Speaker Installation Kit	76000977	Tour-Pak Speaker Installation Kit
	<i>Requires separate purchase of color-matched tour-pak/speaker pods</i>		<i>Requires separate purchase of color-matched tour-pak/speaker pods</i>	
AMPLIFIER <i>Required for ALL speaker setups</i>	76000997	Amplifier 400W 4 Channel w/ DSP -Primary	76000997	Amplifier 400W 4 Channel w/ DSP -Primary
	76001045	Primary Amplifier Installation Kit ('14-16 Touring; except FLHXSE/FLTRXSE)	76001045	Primary Amplifier Installation Kit ('14-16 Touring; except FLHXSE/FLTRXSE)
	76000974	Primary Amplifier Installation Kit ('17-Later Touring; except FLHXSE/FLTRXSE)	76000974	Primary Amplifier Installation Kit ('17-Later Touring; except FLHXSE/FLTRXSE)
SECONDARY AMPLIFIER <i>Required for 6-8 speaker setups only</i>	76000990	Amplifier 400W 4-channel - Secondary	76000990	Amplifier 400W 4-channel - Secondary
	76000975	Secondary Amplifier Installation Kit	76000975	Secondary Amplifier Installation Kit

ROAD KING ('14-LATER)*

	STAGE 1		STAGE 2	
	PART NUMBER	DESCRIPTION	PART NUMBER	DESCRIPTION
SADDLEBAG	<i>Stage 1 not available</i>		76000987	Stage 2 Saddlebags Speakers
			<i>Requires separate purchase of color-matched saddlebag speaker lids</i>	
LOWER FAIRING	<i>Stage 1 not available</i>		76000985	Tour-Pak / Air-Cooled Lower Speakers
			76000978	Air-Cooled Lower Speaker Installation Kit
			<i>Requires separate purchase of color-matched fairing lowers</i>	
TOUR-PAK® <i>Luggage Carrier</i>	<i>Stage 1 not available</i>		76000985	Stage 2 Tour-Pak / Air-Cooled Lower Speakers
			76000977	Tour Pak Speaker Installation Kit
			<i>Requires separate purchase of color-matched tour-pak/speaker pods</i>	
AMPLIFIER <i>Enables one set of speakers. Required for any Road King audio speaker</i>	<i>Stage 1 not available</i>		76001074	Road King Amplifier w/ DSP
			76001113	Road King Audio Install Kit

ROAD GLIDE®/ROAD GLIDE SPECIAL MODELS ('14-LATER)

	STAGE 1		STAGE 2	
	PART NUMBER	DESCRIPTION	PART NUMBER	DESCRIPTION
FAIRING	76000982	Stage 1 Road Glide Fairing Speakers	76000983	Stage 2 Road Glide Fairing Speakers
	76000992	Fairing Speaker Installation Kit	76000992	Fairing Speaker Installation Kit
SADDLEBAG	76000986	Stage 1 Saddlebags Speakers	76000987	Stage 2 Saddlebags Speakers
	76000979	Saddlebag Speaker Installation Kit	76000979	Saddlebag Speaker Installation Kit
	<i>Requires separate purchase of color-matched saddlebag speaker lids</i>		<i>Requires separate purchase of color-matched saddlebag speaker lids</i>	
FAIRING LOWER	76000984	Stage 1 Tour-Pak / Air Cooled Lower Speakers	76000985	Stage 2 Tour-Pak / Air-Cooled Lower Speakers
	76000978	Air-Cooled Lower Speaker Installation Kit	76000978	Air-Cooled Lower Speaker Installation Kit
	<i>Requires separate purchase of color-matched fairing lowers</i>		<i>Requires separate purchase of color-matched fairing lowers</i>	

Notice: The prices appearing in this catalog are the manufacturer's suggested retail prices. Actual retail prices may vary.



ROAD GLIDE®/ROAD GLIDE SPECIAL MODELS ('14-LATER) continued

TOUR-PAK® <i>Luggage Carrier</i>	76000984 Stage 1 Tour-Pak / Air Cooled Lower Speakers	76000985 Stage 2 Tour-Pak / Air-Cooled Lower Speakers
	76000977 Tour-Pak Speaker Installation Kit	76000977 Tour-Pak Speaker Installation Kit
	<i>Requires separate purchase of color-matched tour-pak/speaker pods</i>	
AMPLIFIER <i>Required for ALL speaker setups</i>	76000997 Amplifier 400W 4 Channel w/ DSP -Primary	76000997 Amplifier 400W 4 Channel w/ DSP -Primary
	76001045 Primary Amplifier Installation Kit ('14-16 Touring; except FLHXSE/FLTRXSE)	76001045 Primary Amplifier Installation Kit ('14-16 Touring; except FLHXSE/FLTRXSE)
	76000974 Primary Amplifier Installation Kit ('17-Later Touring; except FLHXSE/FLTRXSE)	76000974 Primary Amplifier Installation Kit ('17-Later Touring; except FLHXSE/FLTRXSE)
SECONDARY AMPLIFIER <i>Required for 6-8 speaker setups only</i>	76000990 Amplifier 400W 4-channel - Secondary	76000990 Amplifier 400W 4-channel - Secondary
	76000975 Secondary Amplifier Installation Kit	76000975 Secondary Amplifier Installation Kit

ULTRA LIMITED MODELS – Twin-Cooled™ ENGINE ('14-LATER)

	STAGE 1		STAGE 2	
	PART NUMBER	DESCRIPTION	PART NUMBER	DESCRIPTION
FAIRING	76000980	Stage 1 Batwing Fairing Speakers	76000981	Stage 2 Batwing Fairing Speakers
	76000992	Fairing Speaker Installation Kit	76000992	Fairing Speaker Installation Kit
SADDLEBAG	76000986	Stage 1 Saddlebags Speakers	76000987	Stage 2 Saddlebags Speakers
	76000979	Saddlebag Speaker Installation Kit	76000979	Saddlebag Speaker Installation Kit
	<i>Requires separate purchase of color-matched saddlebag speaker lids</i>		<i>Requires separate purchase of color-matched saddlebag speaker lids</i>	
FAIRING LOWER	76000988	Stage 1 Twin-Cooled™ Engine Fairing Lower Speakers	76000989	Stage 2 Twin-Cooled™ Engine Fairing Lower Speakers
	76000991	Twin-Cooled™ Engine Lower Speaker Installation Kit	76000991	Twin-Cooled™ Engine Lower Speaker Installation Kit
TOUR-PAK® <i>Luggage Carrier</i>	76000984	Stage 1 Tour-Pak / Air Cooled Lower Speakers	76000985	Stage 2 Tour-Pak / Air-Cooled Lower Speakers
	76000977	Tour-Pak Speaker Installation Kit	76000977	Tour-Pak Speaker Installation Kit
AMPLIFIER <i>Required for ALL speaker setups</i>	76000997	Amplifier 400W 4 Channel w/ DSP -Primary	76000997	Amplifier 400W 4 Channel w/ DSP -Primary
	76001045	Primary Amplifier Installation Kit ('14-16 Touring; except FLHXSE/FLTRXSE)	76001045	Primary Amplifier Installation Kit ('14-16 Touring; except FLHXSE/FLTRXSE)
	76000974	Primary Amplifier Installation Kit ('17-Later Touring; except FLHXSE/FLTRXSE)	76000974	Primary Amplifier Installation Kit ('17-Later Touring; except FLHXSE/FLTRXSE)
SECONDARY AMPLIFIER <i>Required for 6-8 speaker setups only</i>	76000990	Amplifier 400W 4-channel - Secondary	76000990	Amplifier 400W 4-channel - Secondary
	76000975	Secondary Amplifier Installation Kit	76000975	Secondary Amplifier Installation Kit

ULTRA CLASSIC® MODEL ('14-'19)

	STAGE 1		STAGE 2	
	PART NUMBER	DESCRIPTION	PART NUMBER	DESCRIPTION
FAIRING	76000980	Stage 1 Batwing Fairing Speakers	76000981	Stage 2 Batwing Fairing Speakers
	76000992	Fairing Speaker Installation Kit	76000992	Fairing Speaker Installation Kit
SADDLEBAG	76000986	Stage 1 Saddlebags Speakers	76000987	Stage 2 Saddlebags Speakers
	76000979	Saddlebag Speaker Installation Kit	76000979	Saddlebag Speaker Installation Kit
	<i>Requires separate purchase of color-matched saddlebag speaker lids</i>		<i>Requires separate purchase of color-matched saddlebag speaker lids</i>	
FAIRING LOWER	76000984	Stage 1 Tour-Pak / Air Cooled Lower Speakers	76000985	Stage 2 Tour-Pak / Air-Cooled Lower Speakers
	76000978	Air-Cooled Lower Speaker Installation Kit	76000978	Air-Cooled Lower Speaker Installation Kit
TOUR-PAK® <i>Luggage Carrier</i>	76000984	Stage 1 Tour-Pak / Air Cooled Lower Speakers	76000985	Stage 2 Tour-Pak / Air-Cooled Lower Speakers
	76000977	Tour-Pak Speaker Installation Kit	76000977	Tour-Pak Speaker Installation Kit
AMPLIFIER <i>Required for ALL speaker setups</i>	76000997	Amplifier 400W 4 Channel w/ DSP -Primary	76000997	Amplifier 400W 4 Channel w/ DSP -Primary
	76001045	Primary Amplifier Installation Kit ('14-16 Touring; except FLHXSE/FLTRXSE)	76001045	Primary Amplifier Installation Kit ('14-16 Touring; except FLHXSE/FLTRXSE)
	76000974	Primary Amplifier Installation Kit ('17-Later Touring; except FLHXSE/FLTRXSE)	76000974	Primary Amplifier Installation Kit ('17-Later Touring; except FLHXSE/FLTRXSE)



ULTRA CLASSIC® MODEL ('14-'19) continued

	STAGE 1		STAGE 2	
	PART NUMBER	DESCRIPTION	PART NUMBER	DESCRIPTION
SECONDARY AMPLIFIER <i>Required for 6-8 speaker setups only</i>	76000990	Amplifier 400W 4-channel - Secondary	76000990	Amplifier 400W 4-channel - Secondary
	76000975	Secondary Amplifier Installation Kit	76000975	Secondary Amplifier Installation Kit

ROAD GLIDE® ULTRA/LIMITED MODEL – TWIN-COOLED™ ENGINE ('14-LATER)

	STAGE 1		STAGE 2	
	PART NUMBER	DESCRIPTION	PART NUMBER	DESCRIPTION
FAIRING	76000982	Stage 1 Road Glide Fairing Speakers	76000983	Stage 2 Road Glide Fairing Speakers
	76000992	Fairing Speaker Installation Kit	76000992	Fairing Speaker Installation Kit
SADDLEBAG	76000986	Stage 1 Saddlebags Speakers	76000987	Stage 2 Saddlebags Speakers
	76000979	Saddlebag Speaker Installation Kit	76000979	Saddlebag Speaker Installation Kit
	<i>Requires separate purchase of color-matched saddlebag speaker lids</i>		<i>Requires separate purchase of color-matched saddlebag speaker lids</i>	
FAIRING LOWER	76000988	Stage 1 Twin-Cooled™ Engine Fairing Lower Speakers	76000989	Stage 2 Twin-Cooled™ Engine Fairing Lower Speakers
	76000991	Twin-Cooled™ Engine Lower Speaker Installation Kit	76000991	Twin-Cooled™ Engine Lower Speaker Installation Kit
TOUR-PAK® <i>Luggage Carrier</i>	76000984	Stage 1 Tour-Pak / Air Cooled Lower Speakers	76000985	Stage 2 Tour-Pak / Air-Cooled Lower Speakers
	76000977	Tour-Pak Speaker Installation Kit	76000977	Tour-Pak Speaker Installation Kit
AMPLIFIER <i>Required for ALL speaker setups</i>	76000997	Amplifier 400W 4 Channel w/ DSP -Primary	76000997	Amplifier 400W 4 Channel w/ DSP -Primary
	76001045	Primary Amplifier Installation Kit ('14-16 Touring; except FLHXSE/FLTRXSE)	76001045	Primary Amplifier Installation Kit ('14-16 Touring; except FLHXSE/FLTRXSE)
	76000974	Primary Amplifier Installation Kit ('17-Later Touring; except FLHXSE/FLTRXSE)	76000974	Primary Amplifier Installation Kit ('17-Later Touring; except FLHXSE/FLTRXSE)
SECONDARY AMPLIFIER <i>Required for 6-8 speaker setups only</i>	76000990	Amplifier 400W 4-channel - Secondary	76000990	Amplifier 400W 4-channel - Secondary
	76000975	Secondary Amplifier Installation Kit	76000975	Secondary Amplifier Installation Kit

TRI GLIDE® MODEL – TWIN-COOLED™ ENGINE ('14-LATER)*

	STAGE 1		STAGE 2	
	PART NUMBER	DESCRIPTION	PART NUMBER	DESCRIPTION
FAIRING	76000980	Stage 1 Batwing Fairing Speakers	76000981	Stage 2 Batwing Fairing Speakers
	76000992	Fairing Speaker Installation Kit	76000992	Fairing Speaker Installation Kit
TOUR-PAK® <i>Luggage Carrier</i>	76000984	Stage 1 Tour-Pak / Air Cooled Lower Speakers	76000985	Stage 2 Tour-Pak / Air-Cooled Lower Speakers
	76000977	Tour-Pak Speaker Installation Kit	76000977	Tour-Pak Speaker Installation Kit
AMPLIFIER <i>Required for ALL speaker setups</i>	76000997	Amplifier 400W 4 Channel w/ DSP -Primary	76000997	Amplifier 400W 4 Channel w/ DSP -Primary
	76001046	Primary Amplifier Installation Kit ('14-'16 Trike, except Free-wheeler, models)	76001046	Primary Amplifier Installation Kit ('14-'16 Trike, except Free-wheeler, models)
	76000976	Primary Amplifier Installation Kit ('17-Later Trike, except Freewheeler®, models)	76000976	Primary Amplifier Installation Kit ('17-Later Trike, except Freewheeler®, models)
<i>*Up to 4 Speaker Set Only on Trike Models</i>		<i>*Up to 4 Speaker Set Only on Trike Models</i>		

CVO™ TRI GLIDE® MODEL ('20-'21)*

	STAGE 1		STAGE 2	
	PART NUMBER	DESCRIPTION	PART NUMBER	DESCRIPTION
FAIRING	76000980	Stage 1 Batwing Fairing Speakers	76000981	Stage 2 Batwing Fairing Speakers
	76001100	Fairing Speaker Installation Kit	76001100	Fairing Speaker Installation Kit
TOUR-PAK® <i>Luggage Carrier</i>	76000984	Stage 1 Tour-Pak / Air Cooled Lower Speakers	76000985	Stage 2 Tour-Pak / Air-Cooled Lower Speakers
	76000977	Tour-Pak Speaker Installation Kit	76000977	Tour-Pak Speaker Installation Kit



CVO™ TRI GLIDE® MODEL ('20-'21)* continued

	STAGE 1		STAGE 2	
	PART NUMBER	DESCRIPTION	PART NUMBER	DESCRIPTION
AMPLIFIER <i>Required for ALL speaker setups</i>	76000997	Amplifier 400W 4 Channel w/ DSP -Primary	76000997	Amplifier 400W 4 Channel w/ DSP -Primary
	76000976	Primary Amplifier Installation Kit ('17-Later Trike, except Freewheeler®, models)	76000976	Primary Amplifier Installation Kit ('17-Later Trike, except Freewheeler®, models)
	<i>*Up to 4 Speaker Set Only on Trike Models</i>		<i>*Up to 4 Speaker Set Only on Trike Models</i>	

CVO™ LIMITED MODEL ('14-LATER)

	STAGE 1		STAGE 2	
	PART NUMBER	DESCRIPTION	PART NUMBER	DESCRIPTION
FAIRING	76000980	Stage 1 Batwing Fairing Speakers	76000981	Stage 2 Batwing Fairing Speakers
	76001100	Fairing Speaker Installation Kit	76001100	Fairing Speaker Installation Kit
SADDLEBAG	76000986	Stage 1 Saddlebags Speakers	76000987	Stage 2 Saddlebags Speakers
	76000979	Saddlebag Speaker Installation Kit	76000979	Saddlebag Speaker Installation Kit
FAIRING LOWER	76000988	Stage 1 Twin-Cooled™ Engine Fairing Lower Speakers	76000989	Stage 2 Twin-Cooled™ Engine Fairing Lower Speakers
	76000991	Twin-Cooled™ Engine Lower Speaker Installation Kit	76000991	Twin-Cooled™ Engine Lower Speaker Installation Kit
TOUR-PAK® <i>Luggage Carrier</i>	76000984	Stage 1 Tour-Pak / Air Cooled Lower Speakers	76000985	Stage 2 Tour-Pak / Air-Cooled Lower Speakers
	76000977	Tour-Pak Speaker Installation Kit	76000977	Tour-Pak Speaker Installation Kit
AMPLIFIER <i>Required for ALL speaker setups</i>	76000997	Amplifier 400W 4 Channel w/ DSP -Primary	76000997	Amplifier 400W 4 Channel w/ DSP -Primary
	76001045	Primary Amplifier Installation Kit ('14-16 Touring; FLHXSE/FLTRXSE)	76001045	Primary Amplifier Installation Kit ('14-16 Touring; FLHXSE/FLTRXSE)
	76000974	Primary Amplifier Installation Kit ('17-Later Touring; except FLHXSE/FLTRXSE)	76000974	Primary Amplifier Installation Kit ('17-Later Touring; except FLHXSE/FLTRXSE)
SECONDARY AMPLIFIER <i>Required for 6-8 speaker setups only</i>	76000990	Amplifier 400W 4-channel - Secondary	76000990	Amplifier 400W 4-channel - Secondary
	76000975	Secondary Amplifier Installation Kit	76000975	Secondary Amplifier Installation Kit

CVO™ ROAD GLIDE® ULTRA MODEL ('15-16)

	STAGE 1		STAGE 2	
	PART NUMBER	DESCRIPTION	PART NUMBER	DESCRIPTION
FAIRING	76000982	Stage 1 Road Glide Fairing Speakers	76000983	Stage 2 Road Glide Fairing Speakers
	76001100	Fairing Speaker Installation Kit	76001100	Fairing Speaker Installation Kit
SADDLEBAG	76000986	Stage 1 Saddlebags Speakers	76000987	Stage 2 Saddlebags Speakers
	76000979	Saddlebag Speaker Installation Kit	76000979	Saddlebag Speaker Installation Kit
		<i>Requires separate purchase of color-matched saddlebag speaker lids</i>		<i>Requires separate purchase of color-matched saddlebag speaker lids</i>
FAIRING LOWER	76000988	Stage 1 Twin-Cooled™ Engine Fairing Lower Speakers	76000989	Stage 2 Twin-Cooled™ Engine Fairing Lower Speakers
	76000991	Twin-Cooled™ Engine Lower Speaker Installation Kit	76000991	Twin-Cooled™ Engine Lower Speaker Installation Kit
TOUR-PAK® <i>Luggage Carrier</i>	76000984	Stage 1 Tour-Pak / Air Cooled Lower Speakers	76000985	Stage 2 Tour-Pak / Air-Cooled Lower Speakers
	76000977	Tour-Pak Speaker Installation Kit	76000977	Tour-Pak Speaker Installation Kit
AMPLIFIER <i>Required for ALL speaker setups</i>	76000997	Amplifier 400W 4 Channel w/ DSP -Primary	76000997	Amplifier 400W 4 Channel w/ DSP -Primary
	76001045	Primary Amplifier Installation Kit ('14-16 Touring; FLHXSE/FLTRXSE)	76001045	Primary Amplifier Installation Kit ('14-16 Touring; FLHXSE/FLTRXSE)
SECONDARY AMPLIFIER <i>Required for 6-8 speaker setups only</i>	76000990	Amplifier 400W 4-channel - Secondary	76000990	Amplifier 400W 4-channel - Secondary
	76000975	Secondary Amplifier Installation Kit	76000975	Secondary Amplifier Installation Kit



CVO™ STREET GLIDE® MODEL ('21)

	STAGE 1		STAGE 2	
	PART NUMBER	DESCRIPTION	PART NUMBER	DESCRIPTION
FAIRING	-	-	-	FACTORY INSTALLED
SADDLEBAG	-	-	-	FACTORY INSTALLED
FAIRING LOWER	76000984	Stage 1 Tour-Pak / Air Cooled Lower Speakers	76000985	Stage 2 Tour-Pak / Air-Cooled Lower Speakers
	76000978	Air-Cooled Lower Speaker Installation Kit	76000978	Air-Cooled Lower Speaker Installation Kit
		<i>Requires separate purchase of color-matched fairing lowers</i>		<i>Requires separate purchase of color-matched fairing lowers</i>
TOUR-PAK® <i>Luggage Carrier</i>	76000984	Stage 1 Tour-Pak / Air Cooled Lower Speakers	76000985	Stage 2 Tour-Pak / Air-Cooled Lower Speakers
	76000977	Tour-Pak Speaker Installation Kit	76000977	Tour-Pak Speaker Installation Kit
		<i>Requires separate purchase of color-matched tour-pak/speaker pods</i>		<i>Requires separate purchase of color-matched tour-pak/speaker pods</i>
AMPLIFIER <i>Required for ALL speaker setups</i>	-	-	-	FACTORY INSTALLED
SECONDARY AMPLIFIER <i>Required for 6-8 speaker setups only</i>	76000990	Amplifier 400W 4-channel - Secondary	76000990	Amplifier 400W 4-channel - Secondary
	76000975	Secondary Amplifier Installation Kit	76000975	Secondary Amplifier Installation Kit

CVO™ ROAD GLIDE® MODEL ('21)

	STAGE 1		STAGE 2	
	PART NUMBER	DESCRIPTION	PART NUMBER	DESCRIPTION
FAIRING	-	-	-	FACTORY INSTALLED
SADDLEBAG	-	-	-	FACTORY INSTALLED
FAIRING LOWER	76000984	Stage 1 Tour-Pak / Air Cooled Lower Speakers	76000985	Stage 2 Tour-Pak / Air-Cooled Lower Speakers
	76000978	Air-Cooled Lower Speaker Installation Kit	76000978	Air-Cooled Lower Speaker Installation Kit
		<i>Requires separate purchase of color-matched fairing lowers</i>		<i>Requires separate purchase of color-matched fairing lowers</i>
		<i>Required removal of Fairing Spoilers</i>		<i>Required removal of Fairing Spoilers</i>
TOUR-PAK® <i>Luggage Carrier</i>	76000984	Stage 1 Tour-Pak / Air Cooled Lower Speakers	76000985	Stage 2 Tour-Pak / Air-Cooled Lower Speakers
	76000977	Tour-Pak Speaker Installation Kit	76000977	Tour-Pak Speaker Installation Kit
		<i>Requires separate purchase of color-matched tour-pak/speaker pods</i>		<i>Requires separate purchase of color-matched tour-pak/speaker pods</i>
AMPLIFIER <i>Required for ALL speaker setups</i>	-	-	-	FACTORY INSTALLED
SECONDARY AMPLIFIER <i>Required for 6-8 speaker setups only</i>	76000990	Amplifier 400W 4-channel - Secondary	76000990	Amplifier 400W 4-channel - Secondary
	76000975	Secondary Amplifier Installation Kit	76000975	Secondary Amplifier Installation Kit

SELECT YOUR SYSTEM BOOM!™ AUDIO SYSTEMS— STAGE I OR STAGE II

Your bike's factory-equipped Boom!™ Box in-dash audio system and speakers are designed to provide enjoyable full-range sound quality, at a volume level you can hear on the open road. With the addition of Boom! Audio speakers and amplifiers you'll get louder, ride-enhancing sound — thanks to increased frequency response, lower distortion and strong mid-range performance that cut through wind noise. Designed specifically for your ride, Boom! Audio equipment doesn't just sound great — it's engineered tough to withstand the harsh outdoor environment.

STAGE I BOOM!™ AUDIO SYSTEMS

Boom!™ Audio Stage I systems take your sound to the next level. When compared to the factory-installed Original Equipment audio system, Boom! Audio Stage I speakers feature larger woofers for deeper bass and soft-dome tweeters for better balanced sound quality. Efficient Stage I speakers can be easily powered with the built-in amplifier in the factory-installed Boom Box Infotainment System, or with the addition of Boom!™ Audio amplifiers, the larger speakers can produce more volume at all frequencies. A custom EQ was developed for each configuration of speakers to get the most out of the Stage I system.

STAGE I

FOR QUALITY SOUND AND DEEP BASS

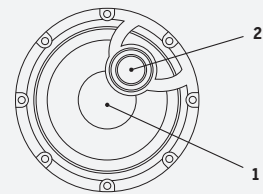

6.5" ROUND SPEAKER (BATWING® FAIRING SPEAKER SHOWN)

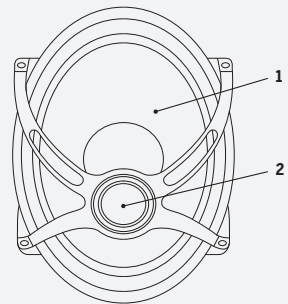

5" x 7" SADDLEBAG SPEAKER

1 WOOFER 2 TWEETER

Boom! Audio Stage I systems achieve clear highs and deep bass for great sound quality. Single amplified, two-way 100-watt per channel speakers feature:

- A woofer and tweeter that deliver great-sounding low and high frequencies
- One 75-watt amplifier channel that powers each speaker

STAGE II

FOR THE PUREST SOUND EXPERIENCE

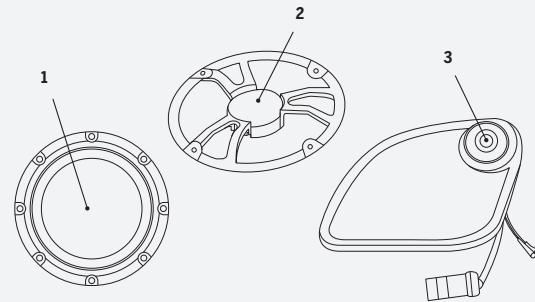

6.5" ROUND SPEAKER (ROAD GLIDE® FAIRING SPEAKER SHOWN)

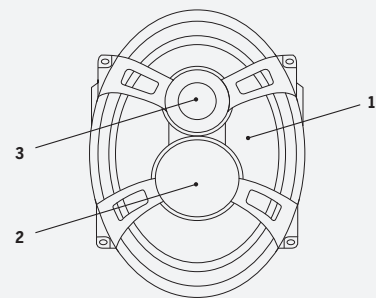

5" x 7" SADDLEBAG SPEAKER

1 WOOFER 2 MID-FREQUENCY DRIVER 3 TWEETER

Boom! Audio Stage II systems achieve the highest quality and purest sound experience on the market with the deepest bass and clearest mids and highs.

- Bi-amplified, three-way 150-watt per channel speakers feature:
- A woofer, a midrange and a tweeter that deliver low, mid and high frequencies through the best driver design
 - Two 75-watt amplifier channels that power each speaker — one powers the woofer and one powers the midrange/tweeter combo

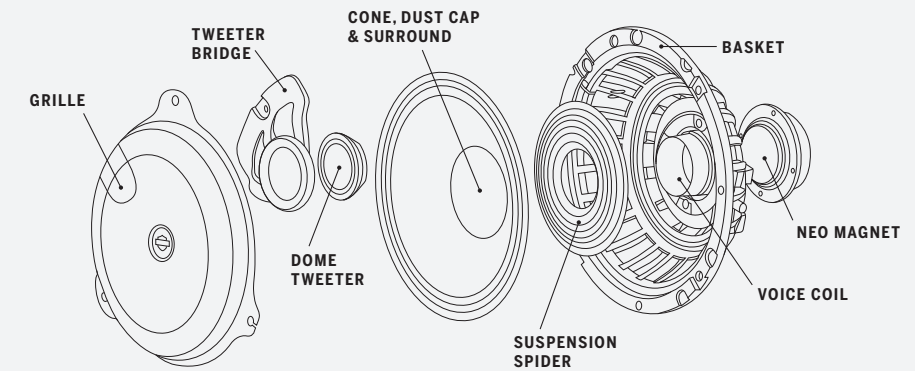

STAGE I BOOM!™ AUDIO – CUTS THROUGH ROAD NOISE TO DELIVER EVERY NOTE							
THE FIRST STEP – Add amplifier(s) and upgrade the factory speakers							
Street Glide® & Road Glide®				Electra Glide® & Road Glide® Ultra			
What Are My Options?	Speaker Locations	Sound Output	# of Speakers/ Amplifiers	What Are My Options?	Speaker Locations	Sound Output	# of Speakers/ Amplifiers
Upgrade Stock Speakers			2/1 150 watts	Upgrade Stock Speakers			4/1 300 watts
WANT MORE? HERE ARE YOUR OPTIONS.							
I RIDE SOLO 4-Speaker*			4/1 300 watts	I RIDE SOLO 6-Speaker*			6/2 450 watts
I RIDE TWO-UP 4-Speaker*			4/1 300 watts	I RIDE TWO-UP 6-Speaker*			6/2 450 watts
I RIDE SOLO & 2-UP 6-Speaker*			6/2 450 watts	THE ULTIMATE SYSTEM 8-Speaker*			8/2 600 watts
THE ULTIMATE SYSTEM 8-Speaker*			8/2 600 watts				

564 AUDIO & GAUGES

Boom!™ Audio – Stage I

A. BOOM!™ AUDIO AMPLIFIER KIT

Take your music to the streets. Boom!™ Audio Amplifier Kits allow you to crank up the volume without distortion. The amplifier provides more power than Original Equipment radio alone, resulting in increased volume, fuller sound reproduction and reduced clipping. Unlike aftermarket amplifiers that connect between the radio and the speakers, the Boom! Audio amplifier bypasses the radio's internal power amp to produce the cleanest sound possible. The Boom! Audio Amplifier boosts the pure source signal, minimizing any distortion generated through the speaker output. The system-matched high-output signal features optimized sound equalization for crisp, clear vocals and maximum bass response and the strong midrange response cuts through wind and road noise. The marine grade, Class D, 4-channel, 75-watt RMS/channel amplifier (300-watt RMS total) has been designed from the ground-up for the harsh motorcycle environment. Fairing Mounted kit includes all mounting hardware and wiring harness. Note: The use of the Boom! Audio Amplifier turns off the radio's internal amplifier.

76000278A Fairing Mounted. **\$657.95**

Fits '14-later Electra Glide®, Street Glide®, Ultra Limited and Tri Glide® models equipped with a Boom! Box audio system. Dealer Digital Technician™ software update is required. Dealer installation is recommended. Separate purchase of Power Extension Harness P/N 69200921 is required if installed with Hidden AM/FM/WB Antenna P/N 76000862, Electra Glo™ Headlamp Trim Rings or Fairing Edge Lights.

76000523 Fairing Mounted. **\$657.95**

Fits '15-later FLTRU, FLTRX and FLTRXS models. Original Equipment on '15-later CVO™ Road Glide® model. Dealer Digital Technician software update is required. Dealer installation is recommended. Separate purchase of Power Extension Harness P/N 69200921 is required if installed with Hidden AM/FM/WB Antenna P/N 76000862, Electra Glo Headlamp Trim Rings or Fairing Edge Lights.

B. BOOM! AUDIO STAGE I SPEAKER EXPANSION KIT

Add more Boom! to your bike. This kit permits the addition of a third or fourth pair of speakers to your Boom! Audio-equipped Touring bike. Choose a combination of Boom! Audio Fairing Lower Speakers and/or Rear Speaker Pods (sold separately) to build a sound system custom-designed to your audio demands. System also provides speaker fade capabilities between fairing and non-fairing mounted speakers for high-way riding, when it's needed most. Kit includes 75-watt/channel (300-watts total) saddlebag-mounted amplifier, amplifier cover, mounting bracket and the required installation hardware and wiring harness. NOTE: The use of the Boom! Audio Amplifier turns off the radio's internal amplifier.

Fits Touring models equipped with a Boom!™ Box audio system. Does not fit '22-later CVO models. Required to add a 3rd or 4th set of Boom!™ Audio Stage I speakers. '18-later FLHTKSE models requires separate purchase of Harness P/N 69201930. Dealer Digital Technician software update is required. Dealer installation is recommended. Not compatible with models equipped with Boom!™ Audio Stage II components.

76000748 Fits '17-later models. **\$788.95**

76000280 Fits '14-'16 models. **\$768.95**

Model Family Fitment:

- V-ROD
- SPORTSTER
- DYNA
- SOFTAIL
- TOURING

Notice: The prices appearing in this catalog are the manufacturer's suggested retail prices. Actual retail prices may vary.



A. BOOM! AUDIO AMPLIFIER



A. BOOM! AUDIO AMPLIFIER KIT – (76000278A SHOWN)



A. BOOM! AUDIO AMPLIFIER KIT – (76000523 SHOWN)



B. BOOM! AUDIO STAGE I SPEAKER EXPANSION KIT



C. BOOM! AUDIO STAGE I BAGGER AMP & SPEAKER KIT – ULTRA 4-SPEAKER KIT (76000959 SHOWN)



D. BOOM! AUDIO STAGE I BAGGER AMP & SPEAKER KIT – STREET GLIDE 2-SPEAKER KIT



D. BOOM! AUDIO STAGE I BAGGER AMP & SPEAKER KIT – ROAD GLIDE 2-SPEAKER KIT



E. BOOM! AUDIO STAGE I FAIRING LOWER SPEAKER KIT



AUDIO & GAUGES 565

Boom!™ Audio – Stage I

BOOM!™ AUDIO STAGE I BAGGER AMP & SPEAKER KITS

Fill the air with sound from this Boom!™ Audio Boom Bagger Kit. Available to fit 2- and 4-speaker models, this complete audio kit provides the latest in Harley-Davidson® audio components. When installed, the increased power of the amplifier provides the speakers with a clean signal and a custom equalization is available to further optimize the performance of the Boom! Audio speaker system. Speakers feature two-year warranty. Dealer Digital Technician™ software update is required. Dealer installation is recommended. Ensure maximum output of your audio system with the recommended High Output Charging System P/N 29900028A. Note: The use of the Boom! Audio Amplifier turns off the radio's internal amplifier. Installation of a third or fourth set of Stage I speakers requires the Boom! Audio Speaker Expansion Kit.

C. 4-SPEAKER ULTRA BOOM! BAGGER KIT

Kit includes Boom! Audio 6.5" fairing and rear speakers, Boom! Audio 4-channel fairing-mounted amplifier, amplifier mount and wiring harness. Boom! Audio speakers feature a two-year warranty.

76000959 **\$1,094.95**

Fits '16-later FLTRU models. Also fits '15-later FLTRX, '20-later FLTRK, '22-later FLTRXST and '15-'17 FLTRXS models equipped with King Tour-Pak® carrier and rear speaker pods. Dealer Digital Technician software update is required. Dealer installation recommended. Separate purchase of Power Extension Harness P/N 69200921 is required if installed with Hidden AM/FM/WB Antenna P/N 76000862.

D. 2-SPEAKER BOOM! BAGGER KIT

Kit includes Boom! Audio 6.5" fairing speakers, Boom! Audio 4-channel fairing-mounted amplifier, amplifier mount and wiring harness. Kit can easily be upgraded to a 4-speaker system with the addition of Saddlebag Lid Speakers, Fairing Lower Speakers or a Tour-Pak and Rear Speaker Enclosures. Boom! Audio speakers feature a two-year warranty.

76000960 **\$872.95**

Fits '14-later FLHT, FLHX, FLHXS and FLHXST models equipped with a Boom!™ Box audio system. Dealer installation is recommended. Separate purchase of Fairing Power Extension Harness P/N 69200921 is required if installed with Hidden AM/FM/WB Antenna P/N 76000862, Electra Glo™ Headlamp Trim Rings or Fairing Edge Lights. Original Equipment on '14-later FLHXS.

76000961 **\$872.95**

Fits '15-later FLTRX, FLTRXST and '15-'17 FLTRXS models. Dealer Digital Technician software update is required. Dealer installation is recommended. Separate purchase of Power Extension Harness P/N 69200921 is required if installed with Hidden AM/FM/WB Antenna P/N 76000862, Electra Glo Headlamp Trim or Fairing Edge Lights. Speakers are Original Equipment on '15-later FLTRXS.

E. BOOM!™ AUDIO STAGE I FAIRING LOWER SPEAKER KIT

Boom!™ Audio Fairing Lower Speakers provide two additional sound sources directed at the rider for a concert-hall sound experience. Adding fairing lower speakers to your current two-speaker system increases the available sound pressure level, permitting higher listening volume, lower distortion and improved clarity at highway speeds. The pair of 6.5" waterproof 2-ohm full range speakers feature suspended 1.0" soft-dome tweeters that are directionally optimized for improved rider acoustics. A molded tray fits tightly into the fairing lower and forms a sound-optimized ported speaker enclosure for improved bass performance. The speakers mount to the fairing lowers with color-matched speaker boxes (sold separately). Kit includes left and right speakers, perforated metal speaker grills, ported lower tray and installation hardware. Fairing lowers sold separately. Boom! Audio speakers feature a two-year warranty.

76000950 **\$324.95**

Fits '14-later FLHT, FLHTCU, FLHTCUL, FLHX, FLHXS, FLTRX and FLTRXS models equipped with vented fairing lowers and a Boom!™ Box audio system. Does not fit models equipped with Twin-Cooled™ engines.

Model Family Fitment:

- V-ROD
- SPORTSTER
- DYNA
- SOFTAIL
- TOURING

Notice: The prices appearing in this catalog are the manufacturer's suggested retail prices. Actual retail prices may vary.

566 AUDIO & GAUGES

Boom!™ Audio – Stage I

A. BOOM!™ AUDIO STAGE I FAIRING SPEAKERS

Make the whole world sing. Boom!™ Audio Speakers are designed to maximize music volume and clarity in the harsh motorcycle environment. The full-range two-way speakers feature high-strength, larger-than-stock polypropylene 6.5" cones for improved low and mid frequencies and bridge-mounted damped soft-dome 1.0" tweeters for improved high frequencies. Composite frame and high-performance magnet increase the speaker's power-handling capabilities. The weather- and vibration-resistant speakers are protected behind perforated metal grills and are sized as a direct replacement for the Original Equipment sound system. Complete kit includes 2 two-way speakers, metal grills and plug-in wiring connection. Boom! Audio speakers feature a two-year warranty.

76000947 6.5" Batwing Fairing Speakers. **\$237.95**
Fits '14-later FLHT, FLHTCU, FLHTCUL, FLHTK, FLHTKL, FLHX, FLHXS and FLHTCUTG models equipped with Boom!™ Box audio system. Requires radio, hand controls and antenna for installation. Original Equipment on '18-later FLHXS models.



A. BOOM! AUDIO STAGE I FAIRING SPEAKER KIT – BATWING

B. BOOM! AUDIO STAGE I SADDLEBAG SPEAKER KIT

Boom! Audio Saddlebag Speakers increase the available sound pressure level (SPL) and produce higher listening volume, lower distortion and improved clarity at highway speeds. The pair of 5" x 7" waterproof 2-ohm full range speakers feature high-strength woofer cones and suspended 25mm tweeters that are directionally optimized for improved rider acoustics. Extensively tested to withstand the harshest riding conditions, the speakers fit seamlessly in custom-designed saddlebag lids (sold separately) and are covered by stylish and durable perforated metal speaker grills. Kit includes left and right speakers, grills, rear wiring harness and installation hardware. Color-matched saddlebag lids sold separately. Boom! Audio speakers feature a two-year warranty.

76000953 **\$419.95**
Fits '14-later FLHT, FLHTCU, FLHTCUL, FLHTK, FLHTKL, FLHX, FLHXS, FLTRU, FLTRX, and FLTRXS models equipped with a Boom!™ Box audio system. Requires radio, hand controls and antenna for installation. Also requires separate purchase of appropriate Saddlebag Lids. Dealer Digital Technician™ software update is required. Dealer installation is recommended.



A. BOOM! AUDIO STAGE I FAIRING SPEAKER KIT – ROAD GLIDE



B. BOOM! AUDIO STAGE I SADDLEBAG SPEAKER KIT



C. TOUR-PAK REAR SPEAKER ENCLOSURE KIT



D. BOOM! AUDIO SPEAKER INSTALLATION KIT – TRIKE BODY



E. COLOR-MATCHED FAIRING LOWER SPEAKER BOXES



F. COLOR-MATCHED SADDLEBAG SPEAKER LIDS

AUDIO & GAUGES 567

Boom!™ Audio – Stage I

C. TOUR-PAK® REAR SPEAKER ENCLOSURE KIT

Add concert-hall sound to your motorcycle. Tour-Pak® Rear Speaker Enclosures enable the installation of Boom!™ Audio 6.5" Rear Speakers on Street Glide® and Road Glide® models equipped with King Tour-Pak luggage. Enclosure Kit includes rear speaker pods and wiring harness for speaker hook-up. Boom! Audio Stage I Tour-Pak 6.5" Rear Speaker Kit P/N 76000318 or Stage II Kit P/N 76000526 sold separately.

76000505 **\$266.95**
Fits '14-later, FLHT, FLHX, FLHXS, FLTRX and FLTRXS models equipped with King Tour-Pak luggage and a Boom! Box audio system. Does not fit with Solo Tour-Pak Mounting Rack P/N 53000225.

D. BOOM!™ AUDIO SPEAKER INSTALLATION KIT – TRIKE BODY*

Add more Boom to your Tri Glide® Trike model. This kit integrates a third set of 6.5" Boom! Audio Speakers in the kick panels of the Tri Glide model, and directs the increased sound pressure level directly at the rider and passenger. The kit includes left and right hidden speaker enclosures, speaker adapter rings, amplifier brackets, wiring harness, hardware and installation template. Amplifier and your choice of Boom! Audio Stage I or II speakers are sold separately.

Fits FLHTCUTG models. Not compatible with Passenger Armrests P/N 52400106 or Trike Saddlebags P/N 84031-11.

76000747A Fits '17-later models. **\$342.95**
76000617 Fits '14-'16 models. **\$319.95**

E. COLOR-MATCHED FAIRING LOWER SPEAKER BOXES

Speaker boxes replace the Original Equipment glove boxes and direct the sound toward the rider and passenger. Kit includes left and right speaker box and required hardware.

Fits '14-later Touring models equipped with vented fairing lowers and Boom! Audio Fairing Lower Speaker Kit P/N 76000487. Does not fit models with Twin-Cooled™ engines.

See Page 773 for complete list of available color-matched options.

F. COLOR-MATCHED SADDLEBAG SPEAKER LIDS

Custom saddlebag lids are shaped to accommodate Boom! Audio Saddlebag Lid Speakers. Speaker openings are formed to angle the speakers and direct the sound forward toward the rider and passenger. Kit reuses Original Equipment hinges, locks and mounting hardware.

Fits '14-later Touring models equipped with Boom! Audio Saddlebag Speaker Kit P/N 76000489.

See Page 773 for complete list of available color-matched options.

Model Family Fitment:

- V-ROD
- SPORTSTER
- DYNA
- SOFTAIL
- TOURING

Notice: The prices appearing in this catalog are the manufacturer's suggested retail prices. Actual retail prices may vary.

*NOTE: '14-'16 Boom! Audio Stage II systems with 6 or 8 speakers require installation of High-Output Charging System P/N 29900028A.

Model Family Fitment:

- V-ROD
- SPORTSTER
- DYNA
- SOFTAIL
- TOURING

Notice: The prices appearing in this catalog are the manufacturer's suggested retail prices. Actual retail prices may vary.

STAGE II BOOM!™ AUDIO SYSTEMS

Boom!™ Audio Stage II systems give you the very best motorcycle sound experience. Stage II systems are based on a bi-amplified, three-way speaker design. Each Stage II speaker features a separate woofer, midrange and tweeter element that allow frequencies to be delivered with the optimum driver design. Each speaker is powered by two channels from the amplifier — one for the woofer, and the second for the midrange/tweeter combination — for a total output of 150 watts/speaker. This doubling of the power allows you to play your music louder with far less distortion than traditional systems.

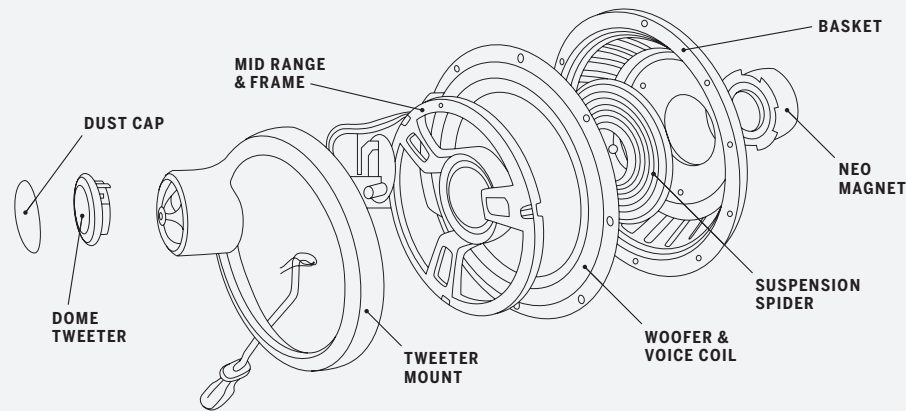

Boom!™ Audio Stage II Fitment Matrix

FLHX/FLHXS*

Fairing	Fairing Speakers	76000524A
	Fairing Amp w/ Mount	76000278A

Saddlebag	Saddlebag Lid Speakers	76000319B
	Installation Kit – '14-'16	76000584
	Installation Kit – '17-later	76000745
	Saddlebag Speaker Amp	76000277B
	Saddlebag Lids – Left†	90200827
	Saddlebag Lids – Right†	90200826

Fairing Lower	Fairing Lower Speakers**	76000353A
	Installation Kit – '14-'16	76000586
	Installation Kit – '17-later	76000749
	Fairing Lower Speaker Amp	76000277B
	Fairing Lower Speaker Boxes†	76000497

Tour-Pak	Tour-Pak® Speakers***	76000526A
	Installation Kit – '14-'16	76000585
	Installation Kit – '17-later	76000751
	Tour-Pak Speaker Amp	76000277B
	Tour-Pak Speaker Pods	76000505

FLTRX/FLTRXS*

Fairing	Fairing Speakers	76000594A
	Fairing Amp w/ Mount	76000523

Saddlebag	Saddlebag Lid Speakers	76000319B
	Installation Kit – '14-'16	76000584
	Installation Kit – '17-later	76000745
	Saddlebag Speaker Amp	76000277B
	Saddlebag Lids – Left†	90200827
	Saddlebag Lids – Right†	90200826

Fairing Lower	Fairing Lower Speakers**	76000353A
	Installation Kit – '14-'16	76000586
	Installation Kit – '17-later	76000749
	Fairing Lower Speaker Amp	76000277B
	Fairing Lower Speaker Boxes†	76000497

Tour-Pak	Tour-Pak Speakers***	76000526A
	Installation Kit – '14-'16	76000585
	Installation Kit – '17-later	76000751
	Tour-Pak Speaker Amp	76000277B
	Tour-Pak Speaker Pods	76000505

FLHTCUTG (Twin-Cooled™)*

Fairing & Tour-Pak	Fairing Speakers	76000524A
	Fairing Amp w/ Mount	76000278
	Tour-Pak Speakers	76000526A
	Installation Kit – '14-'16	76000618
	Installation Kit – '17-later	76000746A
	Tour-Pak Speaker Amp	76000277B

Body	Trike Body Speakers	76000526A
	Installation Kit – '14-'16	76000617
	Installation Kit – '17-later	76000747
	Trike Body Speaker Amp	76000277B

NOTE: Boom!™ Audio Stage I and Boom! Audio Stage II components are not compatible.

FLHTCU/FLHTCUL (Air/Oil-Cooled Models)*

Fairing & Tour-Pak	Fairing Speakers	76000524A
	Fairing Amp w/ Mount	76000278A
	Tour-Pak Speakers	76000526A
	Installation Kit – '14-'16	76000585
	Installation Kit – '17-later	76000751
	Tour-Pak Speaker Amp	76000277B

Fairing Lower	Fairing Lower Speakers	76000353A
	Installation Kit – '14-'16	76000586
	Installation Kit – '17-later	76000749
	Fairing Lower Speaker Amp	76000277B
	Fairing Lower Speaker Boxes†	76000497

Saddlebag	Saddlebag Lid Speakers	76000319B
	Installation Kit – '14-'16	76000584
	Installation Kit – '17-later	76000745
	Saddlebag Speaker Amp	76000277B
	Saddlebag Lids – Left†	90200827
	Saddlebag Lids – Right†	90200826

FLHTCU/FLHTCUL/FLHTK/FLHTKL (Twin-Cooled)*

Fairing & Tour-Pak	Fairing Speakers	76000524A
	Fairing Amp w/ Mount	76000278A
	Tour-Pak Speakers	76000526A
	Installation Kit – '14-'16	76000585
	Installation Kit – '17-later	76000751
	Tour-Pak Speaker Amp	76000277B

Fairing Lower	Fairing Lower Speakers	76000660
	Installation Kit – '14-'16	76000586
	Installation Kit – '17-later	76000749
	Fairing Lower Speaker Amp	76000277B

Saddlebag	Saddlebag Lid Speakers	76000319B
	Installation Kit – '14-'16	76000584
	Installation Kit – '17-later	76000745
	Saddlebag Speaker Amp	76000277B
	Saddlebag Lids – Left†	90200827
	Saddlebag Lids – Right†	90200826

FLTRU (Twin-Cooled)*

Fairing & Tour-Pak	Fairing Speakers	76000594A
	Fairing Amp w/ Mount	76000523
	Tour-Pak Speakers	76000526A
	Installation Kit – '14-'16	76000585
	Installation Kit – '17-later	76000751
	Tour-Pak Speaker Amp	76000277B

Fairing Lower	Fairing Lower Speakers	76000660
	Installation Kit – '14-'16	76000586
	Installation Kit – '17-later	76000749
	Fairing Lower Speaker Amp	76000277B

Saddlebag	Saddlebag Lid Speakers	76000319B
	Installation Kit – '14-'16	76000584
	Installation Kit – '17-later	76000745
	Saddlebag Speaker Amp	76000277B
	Saddlebag Lids – Left†	90200827
	Saddlebag Lids – Right†	90200826

'14-'17 FLHXSE (Twin-Cooled™ Models)*

Fairing Lower	Fairing Lower Speakers	76000660
	Installation Kit – '14-'16	76000586
	Installation Kit – '17-later	76000749
	Fairing Lower Speaker Amp	76000277B
	Installation Kit	76000734

Tour-Pak	Tour-Pak Speakers***	76000526A
	Installation Kit – '14-'16	76000585
	Installation Kit – '17-later	76000751
	Tour-Pak Speaker Amp	76000277B
	Tour-Pak Speaker Pods	76000505
	Audio Input Harness – '15-'16	69201477

'18 FLTRXSE/FLTRXSE (Air/Oil-Cooled)

Tour-Pak	Tour-Pak Speakers	76000526A
	Installation Kit	76000751
	T-Pak Speaker Amp	76000277B
	T-Pak Speaker Pods	76000505

FLHTKSE (Twin-Cooled)*

Fairing & Tour-Pak	Fairing Speakers	76000524A
	Tour-Pak Speakers	76000526A
	Installation Kit – '14-'16	76000585
	Installation Kit – '17-later	76000751
	Tour-Pak Speaker Amp	76000277B
	Interconnect Harness – '14-'17	69200714
	Interconnect Harness – '17-later	69201930
	Jumper Harness	69200489

Saddlebag	Saddlebag Lid Speakers	76000319B
	Installation Kit – '14-'16	76000584
	Installation Kit – '17-later	76000745
	Saddlebag Speaker Amp	76000277B
	Saddlebag Lids – Left†	90200827
	Saddlebag Lids – Right†	90200826
	Saddlebag Handle Kit	90201116

FLTRUSE (Twin-Cooled)*

Fairing & Tour-Pak	Fairing Speakers	76000594A
	Tour-Pak Speakers	76000526A
	Installation Kit – '14-'16	76000585
	Installation Kit – '17-later	76000751
	Tour-Pak Speaker Amp	76000277B
	Interconnect Harness	69200714
	Jumper Harness	69200489

Saddlebag	Saddlebag Lid Speakers	76000319B
	Installation Kit – '14-'16	76000584
	Installation Kit – '17-later	76000745
	Saddlebag Speaker Amp	76000277B
	Saddlebag Lids – Left†	90200827
	Saddlebag Lids – Right†	90200826
	Saddlebag Handle Kit	90201116

* '14-'16 models with 6- and 8-Speaker Systems require installation of High Output Charging System P/N 29900028A.

** Requires separate purchase of Vented Fairing Lower.

*** Requires separate purchase of King Tour-Pak® and Rigid Tour-Pak Mounting Rack.

† Denotes color-matched product.

STAGE II BOOM!™ AUDIO – DELIVERS A PURE HIGH-POWERED CONCERT HALL EXPERIENCE

THE FIRST STEP – Add amplifier(s) and upgrade the factory speakers

Street Glide® & Road Glide®

Electra Glide® & Road Glide® Ultra

What Are My Options?	Speaker Locations	Sound Output	# of Speakers/ Amplifiers	What Are My Options?	Speaker Locations	Sound Output	# of Speakers/ Amplifiers
Upgrade Stock Speakers			2/1 300 watts	Upgrade Stock Speakers			4/2 600 watts
WANT MORE? HERE ARE YOUR OPTIONS.							
I RIDE SOLO 4-Speaker*			4/2 600 watts	I RIDE SOLO 6-Speaker*			6/3 900 watts
I RIDE TWO-UP 4-Speaker*			4/2 600 watts	I RIDE TWO-UP 6-Speaker*			6/3 900 watts
I RIDE SOLO & 2-UP 6-Speaker*			6/3 900 watts	THE ULTIMATE SYSTEM 8-Speaker*			8/4 1200 watts
THE ULTIMATE SYSTEM 8-Speaker*			8/4 1200 watts	● = Factory Speaker Locations ● = Additional Speaker Locations*			

570 AUDIO & GAUGES

Boom!™ Audio – Stage II

BOOM!™ AUDIO STAGE II COMPONENTS*

Headline your own concert tour. Big and bold is the best way to describe the musical performance you will experience when listening to your favorite band through a Boom!™ Audio Stage II sound system. The weather-proof bi-amplified, three-way, 150-watt per channel speakers feature high-excursion woofers and separate mid- and high-frequency drivers. An industry-leading driver design utilizing premium materials to deliver increased accuracy, durability, and responsiveness. Powered by a dedicated 300-watt RMS amplifier, each pair of speakers is capable of producing “filling-rattling” volume. Designed to work seamlessly with the factory installed Boom! Audio infotainment head unit, the Boom! Stage II components are system matched and feature custom-tuned static and dynamic equalization that dial in the ideal setup for your ride. And you can choose how far you want to go. From a single pair of fairing-mounted speakers and a 300-watt amp to a full bore 8-speaker, 4-amp, 1200-watt system, we've got you covered.

A. BOOM! AUDIO AMPLIFIER KIT

Take your music to the streets. Boom! Audio Amplifier Kits allow you to crank up the volume with significantly less distortion. The amplifier provides more power than Original Equipment radio alone, resulting in increased volume, fuller sound reproduction and reduced clipping. Unlike aftermarket amplifiers that connect between the radio and the speakers, the Boom! Audio amplifier bypasses the radio's internal power amp to produce the cleanest sound possible. The Boom! Audio Amplifier boosts the pure source signal, minimizing any distortion generated through the speaker output. The system-matched high-output signal features optimized sound equalization for crisp, clear vocals and maximum bass response and the strong midrange response cuts through wind and road noise. The marine-grade, Class D, 4-channel, 75-watts RMS/channel amplifier (300-watt RMS total) has been designed from the ground-up for the harsh motorcycle environment. Fairing-Mounted kit includes all mounting hardware and wiring harness. Note: The use of the Boom! Audio Amplifier turns off the radio's internal amplifier.

76000278A Fairing Mounted. **\$657.95**
Fits '14-later Electra Glide®, Street Glide®, Ultra Limited and Tri Glide® models equipped with a Boom! Box audio system. Does not fit '22-later CVO™ models. Dealer Digital Technician™ software update is required. Dealer installation is recommended. Separate purchase of Power Extension Harness P/N 69200921 is required if installed with Hidden AM/FM/WB Antenna P/N 76000862, Electra Glo™ Headlamp Trim Rings or Fairing Edge Lights.

76000523 Fairing Mounted. **\$657.95**
Fits '15-later FLTRU, FLTRX and FLTRXS models. Original Equipment on '15-'20 CVO™ Road Glide® model. Dealer Digital Technician software update is required. Does not fit '22-later CVO models. Dealer installation is recommended. Separate purchase of Power Extension Harness P/N 69200921 is required if installed with Hidden AM/FM/WB Antenna P/N 76000862, Electra Glo Headlamp Trim Rings or Fairing Edge Lights.

76000277B Amplifier only. **\$499.95**
Fits '14-later Touring and Tri Glide® models equipped with a Boom!™ Box audio system. Does not fit '22-later CVO models. Required to add a 2nd, 3rd or 4th set of speakers. Dealer Digital Technician software update is required. Dealer installation is recommended.

Model Family Fitment:

V-ROD
 SPORTSTER
 DYNA
 SOFTAIL
 TOURING

Notice: The prices appearing in this catalog are the manufacturer's suggested retail prices. Actual retail prices may vary.

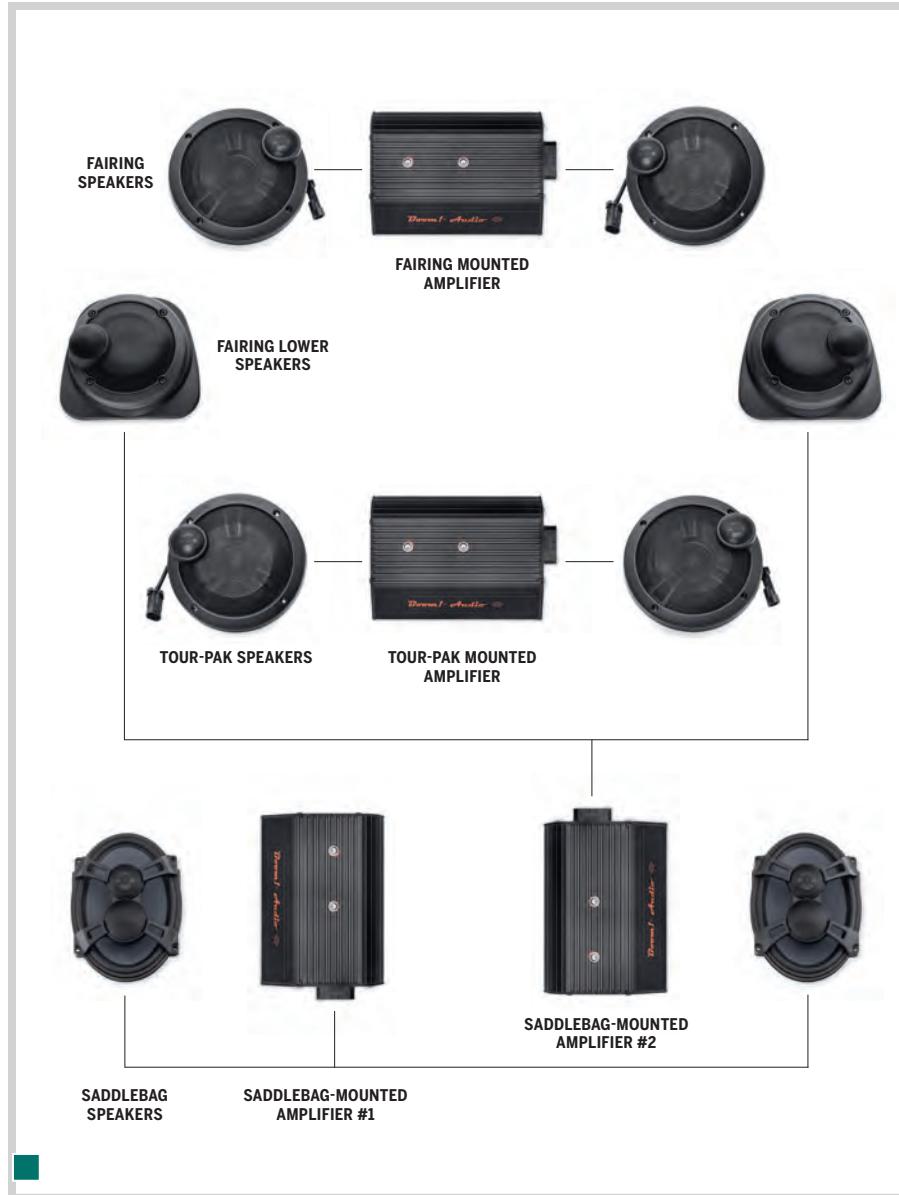

BOOM! AUDIO – STAGE II COMPONENTS



A. BOOM! AUDIO AMPLIFIER KIT – (76000278A SHOWN)



A. BOOM! AUDIO AMPLIFIER KIT – (76000523 SHOWN)

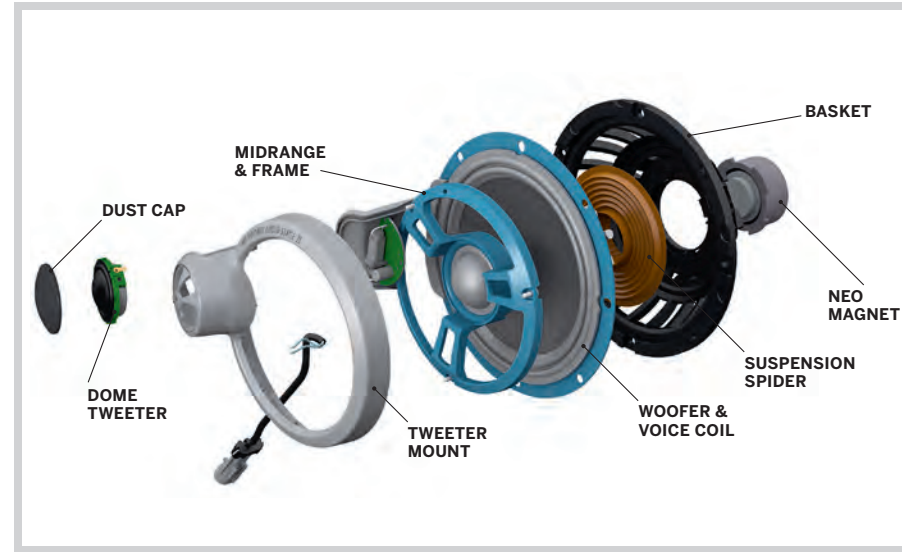

BOOM! AUDIO STAGE II SPEAKER COMPONENTS



B. BOOM! AUDIO STAGE II SPEAKER KIT – BATWING FAIRING



B. BOOM! AUDIO STAGE II SPEAKER KIT – ROAD GLIDE FAIRING

AUDIO & GAUGES 571

Boom!™ Audio – Stage II

B. BOOM!™ AUDIO STAGE II SPEAKER KIT – FAIRING*

Designed for increased volume, sound quality and durability, Stage II Fairing Speakers feature a 6.5" long-throw woofer for low frequencies, a bridge mounted mid-frequency driver, and a separate tweeter for high frequencies. Like true audiophile components, each speaker is powered by two channels from our 300 watt RMS amplifier – one channel powers the woofer, and another powers the mid/tweeter combo. When powered by separate dedicated bass and high-frequency amplifier channels, you are doubling the power to each speaker when compared to our Boom!™ Audio Stage I system. The results? You get thumping bass response, sizzling vocals and clean, distortion-free performance at all volume levels. Built with composite speaker frames, powerful magnets and protective perforated metal grills, these weather and vibration resistant speakers are designed for life on the road. Complete kit includes 2 three-way speakers, grills and plug-in connections. Separate purchase of fairing mount amplifier is required. Boom! Audio speakers feature a two-year warranty.

76000955 Batwing Fairing. **\$347.95**
Fits '14-later FLHT, FLHTCU, FLHTCUL, FLHTK, FLHTKL, FLHTKSE, FLHX, FLHXS and FLHTCUTG models equipped with a Boom!™ Box audio system. Stock on '15-later FLHXSE models. Requires separate purchase of a Boom!™ Audio accessory amplifier. Does not fit '20-later FLHTCUTGSE models. Not compatible with models equipped with Stage I Boom!™ Audio components. Dealer installation and software updates are required.

76000956 Road Glide® Fairing. **\$378.95**
Fits '15-later FLTRK, FLTRU, FLTRUSE, FLTRX and FLTRXS models. Stock on '18-'20 FLTRXSE models. Requires separate purchase of a Boom! Audio accessory amplifier. Not compatible with models equipped with Stage I Boom! Audio components. Dealer installation and software updates are required.

*NOTE: '14-'16 Boom! Audio Stage II systems with 6 or 8 speakers require installation of High-Output Charging System P/N 29900028A.

Model Family Fitment:

V-ROD
 SPORTSTER
 DYNA
 SOFTAIL
 TOURING

Notice: The prices appearing in this catalog are the manufacturer's suggested retail prices. Actual retail prices may vary.

572 AUDIO & GAUGES

Boom!™ Audio – Stage II

A. BOOM!™ AUDIO STAGE II SPEAKER KIT – SADDLEBAGS*

Directionally optimized to fill the rider cockpit with sound, these 5" x 7" Stage II Saddlebag Lid Speakers provide additional depth and dimension to your rolling concert hall. Designed for increased volume, sound quality and durability, these three-way speakers feature a long-throw woofer to handle the low frequencies, and separate bridge-mounted mid- and high-frequency drivers to handle the vocals and the high notes. And, like high-end audiophile components, each speaker is powered by two channels from our 300-watt RMS amplifier—one channel powers the woofer, and another powers the midrange and tweeter combo. Because the speakers are driven by dedicated bass and high-frequency amplifier channels, you get thumping bass response, sizzling vocals and clean distortion-free performance at all volume levels. To really pump up the bass, the closed saddlebags serve as a sealed enclosure. Built with composite speaker frames, powerful magnets and protective perforated metal grills, these weather- and vibration-resistant speakers are designed for life on the road. Complete kit includes 2 three-way speakers, grills and plug-in connections. Boom!™ Audio speakers feature a two-year warranty.

76000954 \$524.95

Fits '14-later FLHT, FLHTCU, FLHTCUL, FLHTK, FLHTKL, FLHTKSE, FLHX, FLHXS, FLTRU, FLTRUSE, FLTRX, and FLTRXS equipped with a Boom!™ Box audio system. Stock on '15-'20 FLHXSE and '18-'20 FLTRXSE models. Does not fit '21-later FLHXSE and FLTRXSE. Stock on '15-later FLHXSE and '18-later FLTRXSE models Requires separate purchase of Color-Matched Saddlebag Lids, Boom! Amplifier and appropriate Stage II Speaker Installation Kit. Not compatible with models equipped with Stage I Boom! Audio components. Dealer installation and software updates are required.

B. BOOM! AUDIO STAGE I/II FAIRING LOWER SPEAKER KIT – TWIN-COOLED™ MODELS*

Designed for installation in the Original Equipment fairing lowers of Twin-Cooled™ Touring models, these vibration-tested waterproof two-way speakers feature rider directed tweeters for clear, crisp sound. The 4" bass/midrange driver and the grill-mounted 1" tweeter are performance-optimized to complement the sound characteristics of both Stage I and Stage II Boom! Audio systems, and provide higher listening volumes with reduced distortion at highway speeds. For easy installation, the speakers are pre-mounted to a backing plate that snaps in place, replacing the fairing lower cooling system access doors. The speakers can be easily removed to check coolant levels. Complete kit includes left and right two-way speakers and wiring harness. Boom! Audio speakers feature a two-year warranty.

76000957 \$314.95

Fits '14-later FLHTCU-TC, FLHTK, FLHTKL, FLHTKSE, FLTRU, FLTRUSE and '14-'17 FLHXSE models with Twin-Cooled engines. FLHT models requires radio, hand controls and antenna for installation. Use on vehicles equipped with Stage II Boom! Audio systems requires the separate purchase of Boom! Audio Amplifier Kit P/N 76000277B and Speaker Installation Kit P/N 76000586 or 76000749. '14-'17 FLHXSE models require separate purchase of Installation Kit P/N 76000734. Does not fit '18-later FLHXSE and FLTRXSE models. Does not fit FLHXSE models equipped with Tour-Pak luggage. Does not fit FLHTKSE models equipped with Boom! Audio Stage II. Not compatible with Screamin' Eagle® Heavy Breather Kits.

Also available: BOOM! AUDIO STAGE I/II FAIRING LOWER SPEAKER INSTALLATION KIT

Kit includes wiring harness required for installation of Boom! Audio Fairing Lower Speaker Kit P/N 76000660 on '14-'17 CVO™ Street Glide® models.

76000734 \$33.95

Fits '14-'17 FLHXSE models.

Model Family Fitment:

V-ROD
 SPORTSTER
 DYNA
 SOFTAIL
 TOURING



A. BOOM! AUDIO STAGE II SPEAKER KIT – SADDLEBAGS



A. BOOM! AUDIO STAGE II SPEAKER KIT – SADDLEBAGS



B. BOOM! AUDIO STAGE I/II FAIRING LOWER SPEAKER KIT – TWIN-COOLED MODELS



B. BOOM! AUDIO STAGE I/II FAIRING LOWER SPEAKER KIT – TWIN-COOLED MODELS



C. BOOM! AUDIO STAGE II SPEAKER KIT – FAIRING LOWERS



D. BOOM! AUDIO STAGE II SPEAKER KIT – TOUR-PAK AND TRI GLIDE TRIKE BODY



E. COLOR-MATCHED FAIRING LOWER SPEAKER BOXES



F. COLOR-MATCHED SADDLEBAG SPEAKER LIDS

AUDIO & GAUGES 573

Boom!™ Audio – Stage II

C. BOOM!™ AUDIO STAGE II SPEAKER KIT – FAIRING LOWERS*

Nestled in the glove boxes of the vented fairing lowers, these 6.5" Stage II speakers are angled toward the rider to provide a wall of sound. Designed for increased volume, sound quality and durability, these Stage II 3-way speakers feature a long-throw woofer for resounding bass, and a bridge-mounted midrange and a separate tweeter to cover the vocals and high frequencies. Each speaker is powered by two channels from our 300-watt RMS amplifier—one channel powers the woofer, and another powers the mid/tweeter combo. When powered by separate dedicated bass and high-frequency amplifier channels, you get double the power to each speaker (when compared to a Boom!™ Audio Stage I system) for higher volume and lower distortion. A molded tray fits tightly into the fairing lower and forms a sound-optimized ported speaker enclosure for improved bass performance. Complete kit includes 2 three-way speakers, fairing lower speaker trays, grills and plug-in connections. Boom! Audio speakers feature a two-year warranty.

76000951 \$425.95

Fits '14-later FLHT, FLHTCU, FLHTCUL, FLHX, FLHXS, FLTRX and FLTRXS models equipped with Boom! Box audio system and fairing lowers. Does not fit models with Twin-Cooled™ engines. Requires separate purchase of Color-Matched Fairing Lower Speaker Boxes, Boom!™ Amplifier and appropriate Stage II Speaker Installation Kit. Not compatible with models equipped with Stage I Boom!™ Audio components. Dealer installation and software updates are required.

D. BOOM! AUDIO STAGE II SPEAKER KIT – TOUR-PAK® AND TRI GLIDE® TRIKE BODY*

Designed for increased volume, sound quality and durability, Stage II 6.5" Tour-Pak® and Trike Body Speakers feature a long-throw woofer for low frequencies, a bridge-mounted mid-frequency driver and a separate tweeter for high frequencies. Like true audiophile components, each speaker is powered by two channels from our 300-watt RMS amplifier—one channel powers the woofer, and another powers the mid/tweeter combo. When powered by separate dedicated bass and high-frequency amplifier channels, you are doubling the power to each speaker when compared to our Boom! Audio Stage I system. The results? You get thumping bass response, sizzling vocals and clean, distortion-free performance at all volume levels. Built with composite speaker frames, powerful magnets and protective perforated metal grills, these weather- and vibration-resistant speakers are designed for life on the road. Complete kit includes 2 three-way speakers, grills and plug-in connections. Boom! Audio speakers feature a two-year warranty.

76000952 \$347.95

Fits '14-later FLHTCU, FLHTCUL, FLHTK, FLHTKL, FLHTKSE, FLTRU, FLTRUSE, and FLHTCUTG models. Also fits FLHT, FLHX, FLHXS, FLTRX, FLTRXS models equipped with a King Tour-Pak®, rigid Tour-Pak® mounting rack and Rear Speaker Enclosure Kit P/N 76000505. Does not fit FLHXSE, FLTRXSE and CVO Trike models. Does not fit '20-later FLHTCUTGSE models. Does not fit models with H-D® Detachables™ Tour-Pak® Mounting Rack. Requires separate purchase of Boom!™ Audio amplifier and appropriate Stage II Speaker Installation Kit. Dealer installation and software updates are required.

E. COLOR-MATCHED FAIRING LOWER SPEAKER BOXES

Fits '14-later Touring models equipped with vented fairing lowers and Boom! Audio Fairing Lower Speaker Kit P/N 76000487. Does not fit models with Twin-Cooled engines.

See *Color-Shop* section for complete list of available color-matched options.

F. COLOR-MATCHED SADDLEBAG SPEAKER LIDS

Fits '14-later Touring models equipped with Boom! Audio Saddlebag Speaker Kit P/N 76000489.

See *Color-Shop* section for complete list of available color-matched options.

*NOTE: '14-'16 Boom! Audio Stage II systems with 6 or 8 speakers require installation of High-Output Charging System P/N 29900028A.

Model Family Fitment:

V-ROD
 SPORTSTER
 DYNA
 SOFTAIL
 TOURING

Notice: The prices appearing in this catalog are the manufacturer's suggested retail prices. Actual retail prices may vary.

Notice: The prices appearing in this catalog are the manufacturer's suggested retail prices. Actual retail prices may vary.

574 AUDIO & GAUGES

Boom!™ Audio – Stage II

A. BOOM!™ AUDIO STAGE II SPEAKER INSTALLATION KIT – FAIRING LOWERS

Kit includes the hardware and wiring harnesses required to install Stage II Fairing Lower Speakers and a Boom!™ Amplifier. Kit includes main wiring harness, quick-disconnect saddlebag wiring harnesses, mount and cover for saddlebag-mounted amplifier and all required hardware. Amplifier, Boom Stage II Speakers and Color-Matched Speaker Boxes are sold separately.

Fits '17-later FLHT, FLHTCU, FLHTK, FLHTKL, FLHX, FLHXS, FLHXSE, FLTRU, FLTRX, and FLTRXS models equipped with fairing lowers and a Boom!™ Box audio system. Does not fit '18-later FLHXSE and FLTRXSE. FLHT models requires radio, hand controls and antenna for installation. Not compatible with models equipped with Stage I Boom!™ Audio components.

76000749	Fits '17-later models.	\$327.95
76000586	Fits '14-'16 models.	\$319.95



A. BOOM! AUDIO STAGE II SPEAKER INSTALLATION KIT – FAIRING LOWERS



B. BOOM! AUDIO STAGE II SPEAKER INSTALLATION KIT – SADDLEBAG

B. BOOM! AUDIO STAGE II SPEAKER INSTALLATION KIT – SADDLEBAG

Kit includes the hardware and wiring harnesses required to install Stage II Saddlebag Speakers and a Boom! Amplifier. Kit includes main wiring harness, quick-disconnect saddlebag wiring harnesses, mount and cover for saddlebag-mounted amplifier and all required hardware. Amplifier, Boom! Stage II Speakers and Color-Matched Speaker Lids are sold separately.

Fits '17-later FLHT, FLHTCU, FLHTK, FLHTKL, FLHTKSE, FLHX, FLHXS, FLTRU, FLTRX and FLTRXS models equipped with a Boom!™ Box audio system. FLHT models requires radio, hand controls and antenna for installation. Also requires separate purchase of Color-Matched Saddlebag Lids. Not compatible with models equipped with Stage I Boom!™ Audio components.

76000745	Fits '17-later models.	\$319.95
76000584	Fits '14-'16 models.	\$319.95



C. BOOM! AUDIO SPEAKER INSTALLATION KIT – TRIKE BODY

C. BOOM! AUDIO SPEAKER INSTALLATION KIT – TRIKE BODY

Add more Boom! to your Tri Glide® Trike model. This kit integrates a third set of 6.5" Boom! Audio Speakers in the kick panels of the Tri Glide model, and directs the increased sound pressure level directly at the rider and passenger. The kit includes left and right hidden speaker enclosures, speaker adapter rings, amplifier brackets, wiring harness, hardware and installation template. Amplifier and your choice of Boom! Audio Stage I or II speakers are sold separately.

Fits FLHTCUTG models. Does not fit CVO™ models. Not compatible with Passenger Armrests P/N 52400106 or Trike Saddlebags P/N 84031-11.

76000747A	Fits '17-later models.	\$342.95
76000617	Fits '14-'16 models.	\$319.95

D. BOOM! AUDIO STAGE II SPEAKER INSTALLATION KIT – TOUR-PAK®

Kit includes the hardware and wiring harnesses required to install Stage II Tour-Pak® Speakers and a Boom! Amplifier. Kit includes main wiring harness, the brackets required to mount the amplifier and all required hardware. Amplifier and Boom Stage II speakers are sold separately.

Fits FLHTCU, FLHTCUL, FLHTK, FLHTKL, FLHTKSE, FLTRU and FLTRUSE models. Also fits FLHT, FLHX, FLHXS, FLTRX, FLTRXS, FLTRXSE and '15-'17 FLHXSE models equipped with a King Tour-Pak®, rigid Tour-Pak® mounting rack, Boom!™ Box audio system, and Boom!™ Audio Rear Speaker Enclosure Kit P/N 76000505. FLHT models requires radio, hand controls and antenna for installation. FLHXSE models require purchase of Audio Input Harness P/N 69201477. '18-later FLHTKSE requires separate purchase of Speaker Interconnect Harness P/N 69201930 and Rear Speaker Jumper Harness P/N 69200489. '17 FLHTKSE and FLTRUSE models require purchase of Speaker Interconnect Harness P/N 69200714 and Rear Speaker Jumper Harness P/N 69200489. Not compatible with models equipped with Stage I Boom!™ Audio components. Does not fit models with H-D® Detachables™ Tour-Pak® Mounting Rack.

76000751	Fits '17-later models.	\$266.95
76000585	Fits '14-'16 models.	\$266.95

Fits FLHTCUTG models. Not compatible with models equipped with Stage I Boom! Audio components.

76000746A	Fits '17-later models.	\$266.95
76000618	Fits '14-'16 models.	\$266.95



D. BOOM! AUDIO STAGE II SPEAKER INSTALLATION KIT – TOUR-PAK (76000585 SHOWN)



D. BOOM! AUDIO STAGE II SPEAKER INSTALLATION KIT – TOUR-PAK (76000746A SHOWN)



E. BOOM! BOX GTS RADIO KIT



F. BOOM! BOX 6.5GT RADIO KIT

AUDIO & GAUGES 575

Boom!™ Audio – '14-later Touring

E. BOOM!™ BOX GTS RADIO KIT

Equipped with a lightning-fast processor for quick start-up and route calculation and with even more memory than previous Boom! Infotainment Systems, the new Boom!™ Box GTS Infotainment System is an evolved interface experience. Available for riders of select Touring model motorcycles, the Boom! Box GTS Radio offers a contemporary look and feel while offering the latest mobile devices and tablet functionality but with durability and features designed specifically for motorcycling. Every element has been optimized to enhance the rider's interaction with the motorcycle and connectivity with the world to ultimately improve the Touring experience. The entire GTS system can be managed from the motorcycle hand controls. It's 6.5" GTS touchscreen is the same size as the 6.5 GT screen but all mechanical buttons and the plastic bezel are eliminated, providing a flat screen. The durable touchscreen glass performs even when used with touch-screen gloves and offers the lowest reflectivity available with minimal sun washout for exceptional visibility in all situations.

76000829A Batwing Fairing. **\$2,017.95**
Fits '19-later FLHTCU and FLHX models with a 4.3 Boom! Box Radio. Also fits '19-later Electra Glide® Standard models with separate purchase of appropriate Hand Controls, Wiring, and Antenna.

76000834A Road Glide® Fairing. **\$2,017.95**
Fits '19-later Road Glide models with a 4.3 Boom! Box Radio.

F. BOOM! BOX 6.5GT RADIO KIT

The Boom! Box 6.5 GT Infotainment System is the ideal upgrade for Touring models equipped with the standard Boom! Box 4.3 radio. One look at the brilliant 6.5" display and you know that this is something special. Boom! Box 6.5GT features a low-distortion 25-watt/channel amplifier that has been optimized for great sound in an open-air environment. The result is cleaner, sharper sound at volumes up to 25% louder than previous Original Equipment radios. Built-in automatic volume control compensates for the increased noise levels as speed increases and automatically adjusts the bass and treble for optimal performance.

The feature-packed radio is factory-equipped with AM/FM radio, weather alert, integrated iPod® and USB audio device playback, map-based GPS navigation and Bluetooth® pairing of mobile phones. The 6.5GT features can be accessed via the glove-friendly touchscreen, joystick hand controls or with hands-free voice recognition. And it doesn't stop there. Optional Bike-to-Bike communication, SiriusXM® satellite radio, XM weather and traffic services and other features are also available.

For a complete rundown of the entire list of Boom! Box 6.5GT features, visit www.H-D.com/infotainment

Fits '14-'18 Touring models with the Boom! Box 4.3 audio system. Also fits '19-later Electra Glide Standard models with separate purchase of appropriate Hand Controls, Wiring and Antenna.

76000512	Europe.	\$1,805.95
76000232C	Rest of the world.	\$1,867.95

BOOM!™ BOX SOFTWARE UPDATE CENTER

Get the latest software for your Boom!™ Box Infotainment System here. Each highly recommended update improves the quality of the system, keeping it running at maximum effectiveness. Start by logging on to www.H-D.com/infotainment

Simply review the list, select your infotainment model number, download the file to a USB memory stick. Then insert it in your Boom! Box Infotainment System's USB port and follow the onscreen instructions to update your system.

Model Family Fitment:

■ V-ROD	■ SPORTSTER	■ DYNA
■ SOFTAIL	■ TOURING	

Notice: The prices appearing in this catalog are the manufacturer's suggested retail prices. Actual retail prices may vary.

Notice: The prices appearing in this catalog are the manufacturer's suggested retail prices. Actual retail prices may vary.

576 AUDIO & GAUGES

Boom!™ Audio – '14-later Touring

A. SIRIUSXM® SATELLITE RADIO KIT

Don't lose the radio reception in the middle of your favorite song. SiriusXM® Satellite Radio is one of the most popular add-ons for Touring models, and it allows you to listen to the same channel as you cross the country. With over 200 digital channels, you'll always find a program that satisfies your taste for music, news, entertainment and sports. The module also provides a 25% increase in data transfer bandwidth to support weather, traffic and future data services. Your radio display provides information regarding artist name, song title and channel information so you will always know what program you are listening to. Channel presets allow you to quickly access your favorite programming. Activation and monthly subscription service required with additional fee.

76000842 **\$425.95**
Fits '19-later Touring and Tri Glide® models equipped with a Boom!™ Box GTS infotainment system.

76000351 **\$425.95**
Fits '14-'18 Touring and Tri Glide models equipped with Boom!™ Box 6.5GT audio system.



A. SIRIUSXM SATELLITE RADIO KIT (76000842 SHOWN)



A. SIRIUSXM SATELLITE RADIO KIT (76000351 SHOWN)

B. MUSIC AND COMMUNICATIONS KIT

Add rider headphone access to music and helmet microphone activation of voice recognition and hands-free phone features of the Boom! Box Radio. Plug-in wiring harness allows rider to connect a standard 7-pin DIN communications headset to the radio to maximize the use of the infotainment system's convenience features. Discrete tank port accepts 7-pin plugs for rider. Works with Boom! Audio full- and half-helmet music and communication headsets. Kit includes wiring harness, rider plug-in ports, weatherproof under-seat port cover and all necessary mounting hardware.

69200865 **\$74.95**
Fits '14-later FLHT, FLHX, FLHXS, FLHXST and '15-later FLTRX, FLTRXS and FLTRXST models (except models set up for wireless headsets). Dealer Digital Technician™ software update is required.



B. MUSIC AND COMMUNICATIONS KIT



C. BIKE-TO-BIKE COMMUNICATIONS KIT

C. BIKE-TO-BIKE COMMUNICATIONS KIT

Communicate with your friends on any of 40 channels. Easy to use handlebar controls allow Push-To-Talk (PTT) and adjustable squelch levels for maximum performance and reception quality. Integrated CB System will mute the radio while in transmit or receive mode. Bike-to-Bike system allows you and your passenger to talk with other riders, even when you are miles apart.

76000486A **\$356.95**
Fits '14-later FLHTCU, FLHTCUL, FLHTCUTG and FLTRU, '17-later FLHTK and FLHTKL, '20-later FLTRK and '21-later FLHTKSE models with a Boom!™ Box audio system. Requires separate purchase of Shorty CB Antenna P/N 76386-09A or Whip Antenna 76250-09 and Mounting Stud P/N 76000166. Also requires P/N 71500130C for '14-later models.



D. 3.5MM AUXILIARY INPUT KIT

D. 3.5MM AUXILIARY INPUT KIT

Add additional music and information source options to your Boom! Box-equipped Harley-Davidson® model. Harness enables GPS units, phones and music players equipped with a 3.5mm mini plug to feed their signal directly to the Boom! Box receiver. Harness length permits running cable to fairing-mounted Jukebox door or glove compartment or behind fairing to a GPS mount.

69200907 **\$43.95**
Fits '14-later Electra Glide®, Road Glide®, Street Glide®, Ultra Limited and Tri Glide models equipped with a Boom!™ Box audio system.



BOOM!™ BOX SOFTWARE UPDATE CENTER

Get the latest software for your Boom!™ Box Infotainment System here. Each highly recommended update improves the quality of the system, keeping it running at maximum effectiveness. Start by logging on to www.H-D.com/infotainment

Simply review the list, select your infotainment model number, download the file to a USB memory stick. Then insert it in your Boom! Box Infotainment System's USB port and follow the onscreen instructions to update your system.

Model Family Fitment:

- V-ROD
- SPORTSTER
- DYNA
- SOFTTAIL
- TOURING

Notice: The prices appearing in this catalog are the manufacturer's suggested retail prices. Actual retail prices may vary.

AUDIO & GAUGES 577

WIRELESS HEADSET COMMUNICATIONS

		FULL or 3/4 HELMET				HALF HELMET
		HARLEY-DAVIDSON® AUDIO 50C BLUETOOTH® HEADSET	HARLEY-DAVIDSON® AUDIO 50S BLUETOOTH® HEADSET	BOOM!™ AUDIO 30K BLUETOOTH® HEADSET	BOOM!™ AUDIO 20S EVO BLUETOOTH® HELMET HEADSET	BOOM!™ AUDIO EXPAND 2.0 BLUETOOTH® HALF HEADSET
		76001180 (Single Only)	76001178 (Single) 76001179 (Dual Pack)	76000838 (Single) 76000840 (Dual Pack)	76000736A (Single) 76000740A (Dual Pack)	76001082
START HERE	FOR MODELS EQUIPPED WITH BOOM!™ BOX 6.5 GT OR GTS RADIO AND THE WHIM (SOLD SEPARATELY)	Listen to Your Bike and Talk to Your Passenger + Your Mesh Group			Listen to Your Bike and Talk to Your Passenger + Your Group (Bluetooth®)	NOT COMPATIBLE
	FOR ALL MODELS WITHOUT WHIM	Talk to Your Group (Bluetooth® & Mesh Network) OR Talk to Your Group (Mesh Network) + Your Smartphone			Talk to Your Group (Bluetooth®) + Your Smartphone	Talk to Your Group (Bluetooth®) OR Connect to Your Smartphone
ADVANCED NOISE CONTROL	Ambient noise cancellation for incoming and outgoing audio	✓	✓	✓	✓	✓
AUDIO BOOST	Automatic volume boost to counteract ambient noise	✓	✓	✓	✓	✓
AMBIENT MODE	Option to hear regular road and surrounding noises	✗	✓	✓	✓	✗
FM RADIO	10 preset station memory for integrated FM Radio	✓	✓	✓	✓	✗
STEREO SOUND	Audio from both speakers for all functions	✓	✓	✓	✓	✓
UNIVERSAL INTERCOM	Ability to connect with any headset via Bluetooth® regardless of manufacturer	✓	✓	✓	✓	✓
BLUETOOTH® INTERCOM	Ability to wirelessly communicate with other riders (max. # of connections)	Up to 4-Way Intercom	Up to 4-Way Intercom	Up to 4-Way Intercom	Up to 8-Way Intercom	Up to 4-Way Intercom
MESH INTERCOM™	Advanced wireless communication with other riders - simplified pairing process (max. # of connections)	Up to 24-Way Group Mesh Intercom / Virtually Limitless Within 1Mi / 1.2Km (Public Mesh)	Up to 24-Way Group Mesh Intercom / Virtually Limitless Within 1Mi / 1.2Km (Public Mesh)	Up to 16-Way Intercom (Private Mode) / Virtually Limitless within 1 Mi / 1.2 Km (Public Mode)	✗	Up to 16-Way Intercom (Private Mode) / Virtually Limitless within 1 Mi / 1.2 Km (Public Mode)
WORKING DISTANCE	Maximum working distance under optimal conditions	Up to 5 Mi / 8 Km	Up to 5 Mi / 8 Km	Up to 5 Mi / 8 Km	Up to 4.3 Mi / 7.0 Km	Up to 5 Mi / 8 Km
AUDIO MULTITASKING	Simultaneous operation of multiple audio functions	✓	✓	✓	✓	✗
TALK TIME	Time in hours of usage (Bluetooth®)	Up to 22 Hours	Up to 14 Hours	Up to 13 Hours	Up to 13 Hours	Up to 10 Hours
VIDEO RECORDING TIME	Time in hours of usage	Up to 1 Hour and 40 min	✗	✗	✗	✗
RAPID CHARGE	Charges quickly over a short period of time	✗	✓	✓	✗	✗
WIFI FIRMWARE	WiFi firmware updates	✓	✓	✗	✗	✗
CHARGE TIME	Time in hours to full charge	2.5 Hours	1 Hours	1.5 Hours	1.5 Hours	2.5 Hours
VIDEO/CAMERA	Integrated 4K video 12MP camera	✓	✗	✗	✗	✗
ULTRA PREMIUM SPEAKERS	H-D® Audio powered by Rockford Fosgate® speakers	Included	Included	Sold Separately (P/N 76001137)	Sold Separately (P/N 76001137)	✗
VOICE COMMANDS	Control your device with your voice	✓	✓	✗	✗	✗

AUDIO & GAUGES

578 AUDIO & GAUGES

Headsets

A. WIRELESS HEADSET INTERFACE MODULE

It's time to cut the cord with your bike. Now available for '14-later Touring and Trike models equipped with Boom!™ Audio 6.5GT and GTS Radios, this Wireless Headset Interface Module (WHIM) lets you communicate with your bike without being wired to it. The WHIM Bluetooth® adapter permits wireless connectivity to the 6.5GT infotainment system, allowing you to communicate via CB radio, hear turn-by-turn GPS directions, listen to your favorite radio stations and so much more all through your Bluetooth-enabled headset.

Bluetooth® Wireless Technology

Wireless interface permits full access to the Infotainment features without the hassle of being connected to the bike. You have full freedom of movement for turning your head and getting off the bike at fuel stops.

Integrated Into the 6.5GT and GTS Radio

Seamlessly use all wired headset functionality (CB, Phone, Intercom, Navigation, Radio) without the compromises of aftermarket systems, and configure your Boom! Audio 20S headset directly from the radio controls.

Superior Audio Quality

Harley-Davidson® headsets feature proprietary software that delivers superior audio quality with stereo output compared to non-Harley™ headsets, which provide a mono sound output.

Dual Headset Connectivity

Two Bluetooth-enabled headsets can be connected to one WHIM, simplifying installation and keeping costs in line.

Integrated Behind the Fairing

Module mounts behind the fairing and connects directly to the radio, eliminating external wires and connections to console and Tour-Pak® communication ports.

Compatible with H-D® Wireless Headsets

Current H-D® wireless headsets are completely compatible. No need to purchase new headsets to use the WHIM system. Harley headset volume can be adjusted from the motorcycle hand controls.

Impact of Retrofit on Wired Microphone Functionality

Upon installation of the WHIM, your motorcycle's wired microphone functionality will no longer be available. However, wired audio will continue to function as before.

76000768 **\$332.95**

Fits '14-later Touring and Trike models equipped with a Boom! Box 6.5GT or Boom! Box GTS audio system. '14-'17 models require the separate purchase of Wireless Headset Interface Module Harness P/N 69201726. Installation on models may result in reduced satellite radio reception. Dealer Digital Technician™ software update is required. Dealer installation is recommended.

Also available:

WIRELESS HEADSET INTERFACE MODULE HARNESS

Required for installation of Wireless Headset Interface Module on '14-'17 Touring and Trike models.

69201726 **\$63.95**

Fits '14-'17 Touring and Trike models equipped with a Boom! Box 6.5GT audio system and Wireless Headset Interface Module P/N 76000768. Installation on vehicles with satellite radio may interfere with satellite radio or wireless headset performance.



A. WIRELESS HEADSET INTERFACE MODULE



A. WIRELESS HEADSET INTERFACE MODULE

Model Family Fitment:

- V-ROD
- SPORTSTER
- DYNA
- SOFTAIL
- TOURING

Notice: The prices appearing in this catalog are the manufacturer's suggested retail prices. Actual retail prices may vary.

AUDIO & GAUGES 579

Headsets

B. HARLEY-DAVIDSON® AUDIO 50S BLUETOOTH® HEADSET

The flagship Harley-Davidson® Audio 50S Bluetooth Headset is engineered to simplify and extend wireless communication, now equipped with Harley-Davidson® Audio powered by Rockford Fosgate® Stage I Speakers for Wireless Headsets for outstanding audio. The 50S Headset comes with 2 modules (1 Bluetooth 5 and 1 Mesh 2.0) and offers an exceptional integrated experience when paired to your bike's Boom!™ Box infotainment system via the Wireless Headset Interface Module (WHIM), sold separately. When paired with the WHIM, you can enjoy full stereo sound, use the bike's infotainment screen to configure select features of your headset, and leverage the existing hand controls to ensure safe and controlled riding as you move effortlessly through music, phone, GPS and push-to-talk intercom conversations. This headset is also compatible with Apple CarPlay and Android Auto through a Boom! Box GTS Radio, with voice-activated digital assistant access ("Hey Google"/"Hey Siri"). Without the WHIM, you can control your 50S through available hands-free voice commands or the glove-friendly jog dial menu navigation. And, if you prefer to use earbuds, there is an available earbud port in the base. Kit includes headset, mics and all necessary installation hardware.

Harley-Davidson® Audio powered by Rockford Fosgate® Stage I Speakers for Wireless Headsets provide the ultimate in motorcycle audio performance with rich bass and clarity at any volume. 30% faster rapid charging when compared to previous generation headsets. Automatic firmware updates via the included WiFi Adapter. Ambient Mode: Option to hear regular road and surrounding noises. Advanced Noise Control: Ambient noise cancellation for incoming and outgoing audio. Audio Boost: Automatic volume boost to counteract ambient noise. FM Radio: 10 preset station memory integrated FM radio. Audio plays from both speakers for all functions. Universal Intercom: Ability to connect with any headset via Bluetooth® regardless of manufacturer. Bluetooth Intercom: Ability to wirelessly communicate with other riders (up to 4-way intercom). Mesh Intercom Network: Ability to wirelessly communicate with other riders without pairing. Up to 16-way intercom (private mode) / Virtually limitless within 1 mi/1.2 Km (public mode). Audio Multitasking: Simultaneous operation of multiple audio functions. Mesh Talk Time: up to 9 hours. Charge Time: fully charged in only an hour; provides up to 9 hours of Mesh intercom talk time or 14 hours of Bluetooth intercom talk time. Working Distance: up to 5 miles/8 Km under optimal conditions.

Fits most Harley-Davidson® full and 3/4 helmets. Bluetooth headset is compatible with Harley-Davidson Original Equipment 6.5GT Boom! Box and Boom! Box GTS radio when equipped with Wireless Headset Interface Module P/N 76000768. Bluetooth headset is compatible with most smartphones when vehicle is not equipped with Wireless Headset Interface Module. Headset speakers intended for helmets with speaker cut-outs.

76001178	Single Headset.	\$378.95
76001179	Dual Headset Pack.	\$673.95



B. HARLEY-DAVIDSON AUDIO 50S BLUETOOTH HEADSET



B. HARLEY-DAVIDSON AUDIO 50S BLUETOOTH HEADSET

Model Family Fitment:

- V-ROD
- SPORTSTER
- DYNA
- SOFTAIL
- TOURING

Notice: The prices appearing in this catalog are the manufacturer's suggested retail prices. Actual retail prices may vary.

580 AUDIO & GAUGES

Headsets

A. HARLEY-DAVIDSON® AUDIO 50C BLUETOOTH® HEADSET WITH CAMERA

The Harley-Davidson® Audio 50C Bluetooth Headset adds a built-in 4K camera to Harley-Davidson's flagship wireless headset. Engineered to simplify and extend wireless communication, this headset is also equipped with Harley-Davidson® Audio powered by Rockford Fosgate® Stage I Speakers for Wireless Headsets for outstanding audio. The 50C Headset comes with 2 modules (1 Bluetooth 5 and 1 Mesh 2.0) and offers an exceptional integrated experience when paired to your bike's Boom!™ Box infotainment system via the Wireless Headset Interface Module (WHIM), sold separately. When paired with the WHIM, you can enjoy full stereo sound, use the bike's infotainment screen to configure your headset, and leverage the existing hand controls to ensure safe and controlled riding as you move effortlessly through music, phone, GPS and push-to-talk intercom conversations. This headset is also compatible with Apple CarPlay and android Auto through a Boom! Box GTS Radio, with voice-activated digital assistant access ("Hey Google"/"Hey Siri"). Without the WHIM, you can control your 50C through available hands-free voice commands or the glove friendly jog dial menu navigation. And, if you prefer to use earbuds, there is an available earbud port in the base. Kit includes headset, mics and all necessary installation hardware.

Built-in camera offers 4K video recording and 12MP camera capability for outstanding image quality when recording on- or off-road adventures. Harley-Davidson® Audio powered by Rockford Fosgate® - Stage I Speakers for Wireless Headsets speakers provide the ultimate in motorcycle audio performance with rich bass and clarity at any volume. 30% faster rapid charging when compared to previous generation headsets. Automatic firmware updates via the included WiFi Adapter. Ambient Mode: Option to hear regular road and surrounding noises. Advanced Noise Control: Ambient noise cancellation for incoming and outgoing audio. Audio Boost: Automatic volume boost to counteract ambient noise. Electronic Image Stabilization within 1080P (60fps & 30fps). External Memory: MicroSD card (U3 or higher) up to 128 GB (not included). FM Radio: 10 preset station memory integrated FM radio. Audio plays from both speakers for all functions. Mesh Intercom Network: Ability to wirelessly communicate with other riders without pairing. Up to 16-way intercom (private mode) / Virtually limitless within 1 mi/1.6 Km (Open Mesh - 9 channels). Bluetooth Intercom: Ability to wirelessly communicate with other riders (up to 4-way intercom). Audio Multitasking: Simultaneous operation of multiple audio functions. Mesh Talk Time: up to 12 hours. Charge Time: fully charged in only an hour; provides up to 9 hours of Mesh intercom talk time or 22 hours of Bluetooth intercom talk time. Bluetooth Intercom Distance: up to 1.2 miles/2 Km under optimal conditions.

76001180 Single Headset. **\$524.95**
Fits most Harley-Davidson® full and 3/4 helmets. Bluetooth headset is compatible with Harley-Davidson Original Equipment 6.5GT Boom! Box and Boom! Box GTS radio when equipped with Wireless Headset Interface Module P/N 76000768.



A. HARLEY-DAVIDSON AUDIO 50C BLUETOOTH HEADSET



A. HARLEY-DAVIDSON AUDIO 50C BLUETOOTH HEADSET

Model Family Fitment:
 V-ROD
 SPORTSTER
 DYNA
 SOFTAIL
 TOURING

Notice: The prices appearing in this catalog are the manufacturer's suggested retail prices. Actual retail prices may vary.

AUDIO & GAUGES 581

Headsets

B. HARLEY-DAVIDSON® AUDIO POWERED BY ROCKFORD FOSGATE® - STAGE I SPEAKERS FOR WIRELESS HEADSETS

Upgrade audio performance with these Harley-Davidson® Audio powered by Rockford Fosgate® - Stage I Speakers for Wireless Headsets. These in-helmet speakers were designed in collaboration with the audio experts at Rockford Fosgate® to deliver increased frequency response and reduced total harmonic distortion for superior bass and clarity when compared to previous generation Boom! Bluetooth Communication speakers. Provide noticeable audio playback improvement at volume for improved sound quality at highway speeds. Provide more bass response at all volume levels. Easy installation as a replacement for speakers in Harley-Davidson® Boom!™ Audio 30k and 20S Bluetooth® Helmet Headsets. Ideal fitment inside helmets designed with speaker cut-outs. Bar & Shield in speaker foam and Rockford Fosgate medallion on back of speaker for added style. To ensure the best sound from your Harley-Davidson Audio powered by Rockford Fosgate Bluetooth Headset Stage I Speakers, update the firmware in the headset to the latest Rockford Fosgate speaker equipped version. Visit H-D.com for details.

76001137 **\$83.95**
Fits Harley-Davidson Boom! Audio 30K and 20S Evo Bluetooth Helmet Headsets Requires firmware update to Boom! Audio Bluetooth headset to enable Harley-Davidson Audio speaker tuning..



B. HARLEY-DAVIDSON AUDIO POWERED BY ROCKFORD FOSGATE - STAGE I SPEAKERS FOR WIRELESS HEADSETS

C. BOOM!™ AUDIO EXPAND 2.0 BLUETOOTH® HALF HELMET HEADSET

The one-piece headset allows you to call hands-free on your Bluetooth mobile phone, listen to stereo music or GPS navigation instructions and have intercom conversations in full duplex with your passenger and/or fellow riders. Bluetooth 3.0 and advanced digital processing technology permits connectivity with other devices up to 980 yards (900 meters) away, while delivering best-in-class incoming and outgoing sound quality. The headset can be easily paired with up to two phones, and because it operates on the Universal Intercom protocol, the headset can be connected with your fellow rider's gear—regardless of the manufacturer. The Bluetooth 3.0 stereo headset brings your favorite tunes, GPS navigation, four-way intercom conversations and hands-free calling to any type of motorcycle. The simple-to-operate glove-friendly jog dial and large buttons on the headset control the major functions, and the comfortable ear hooks and behind-the-neck strap keep the headset firmly in place while riding. Boom! Audio Expand Bluetooth headsets feature automatic volume boost and Advanced Noise Control technology to produce crystal clear audio in noisy environments. The headset is fully water resistant, and the long-life battery permits up to 10 hours of talk time and seven days of standby on a single charge. Kit includes Headset, micro USB charger and instructions. Want the best in hands-free tech for your bike? The Boom! Audio Expand Half-Helmet Headset, coupled the Boom! Box 6.5GT Radio and with the Harley-Davidson® Wireless Interface Module (WHIM) (both sold separately), provides the best hands-free experience. When coupled with the WHIM, it replaces the wired headset connection to the bike.

76001082 **\$170.95**
Fits most Harley-Davidson® half helmets. Bluetooth headset is compatible with Harley-Davidson Original Equipment Boom! Audio 6.5GT or GTS radios when equipped with Wireless Headset Interface Module P/N 76000768.



C. BOOM! AUDIO EXPAND 2.0 BLUETOOTH HALF HELMET HEADSET

D. BOOM! AUDIO HALF HELMET MUSIC AND COMMUNICATIONS HEADSET

Lightweight, durable neck bow wraps around the ear and across the back of the neck and fits comfortably below the shell of most half helmets. The adjustable boom microphone with wind sock has been optimized for superior clarity when connected to Harley-Davidson intercom and Bike-to-Bike communications equipment and the quick-disconnect plug allows you to step away from the motorcycle without removing the headset. A clothing clip (not shown) is included for added comfort and reduced ear fatigue. The coiled cord permits freedom of movement in the saddle. The 7-pin DIN plug can be connected to the front and rear communications ports, allowing both rider and passenger access to the music, navigation and voice communications features of the motorcycle.

76572-09 7-pin DIN Connector. **\$129.95**
Fits '98-later FLHTCU, FLHTCUSE, FLHTK, FLHTKSE, FLTRK, FLTRU, FLTRUSE and FLHTCUTG models. Also fits with vehicles equipped with Communication Switch Kit P/N 77173-08 or Boom! Audio Music and Intercom Kits.

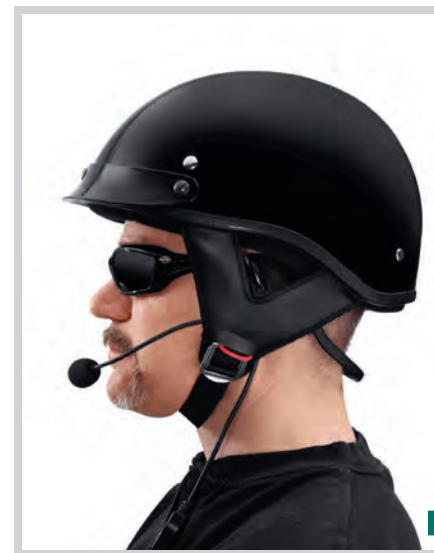

D. BOOM! AUDIO HALF HELMET MUSIC AND COMMUNICATIONS HEADSET

Notice: The prices appearing in this catalog are the manufacturer's suggested retail prices. Actual retail prices may vary.

582 AUDIO & GAUGES

Phone Mounts

HARLEY-DAVIDSON® UNIVERSAL PHONE CARRIER

This phone mount system is certified by Harley-Davidson to withstand the same testing endured by all of our motorcycle accessories, including UV exposure, adhesion pull-off testing, vibration and latch cycle testing, and even aerodynamic loads. Harley has over-engineered this mount to ensuring your phone stays connected to the bike.

- Rugged construction - CNC-machined from 6063 aluminum to be lightweight and durable.
- Easy installation with choice of handlebar or clutch mount.
- No custom case required - Adhesive mount attachment point can be attached to most cell phone cases. Simply clean the phone case surface and verify a good adhesive bond strength between phone case and universal interface
- Rotates for vertical or horizontal viewing.
- Will hold almost any smart phone on the market.

A. UNIVERSAL PHONE CARRIER + CLUTCH MOUNT

Mounts to left hand control.

Fits '20-later ELW, '02-'17 VRSC™, '21-later RA1250, RA1250S and RH1250S, '15-'20 XG, '04-'22 XL (except XL88N, XL1200NS, and XL1200N), '08-'13 XR, '06-'17 Dyna® (except FXDB), '00-later Softail®, '09-later Touring (except '09-'13 FLHTCUSE and '14-'16 FLHTKSE), and '09-later Trike.

76001071	Black.	\$107.95
76001339	Chrome.	\$109.95

B. UNIVERSAL PHONE CARRIER + HANDLEBAR MOUNT

Includes three shims to mount securely to 0.875" to 1.250" diameter handlebar.

Fits '20-later ELW, '02-'17 VRSC™, '21-later RA1250, RA1250S and RH1250S, '15-'20 XG, '04-'22 XL (except XL88N, XL1200NS, and XL1200N), '08-'13 XR, '06-'17 Dyna® (except FXDB), '00-later Softail®, '09-later Touring (except '09-'13 FLHTCUSE and '14-'16 FLHTKSE), and '09-later Trike. Not recommended for Batwing Touring models with stock handlebars.

76001072	Black.	\$107.95
76001340	Chrome.	\$109.95

C. UNIVERSAL HANDLEBAR MOUNT PHONE CARRIER

Put your smartphone within easy reach. This standard cradle places your phone or music device close to the hand controls of the motorcycle for easy access. Makes it easy to change from device to device. Simple to use, single adjustment screw to lock phone in place. Once secured in the carrier your phone can be attached to or detached from the mount in seconds. No permanent adhesive mount required. Does not interfere with operation of touchscreen and use of buttons remains possible. Holds devices measuring 2.2" to 3.2" wide.

76000549 **\$45.95**
Fits '02-'17 VRSC (except VRSCF and VRSCR), '15-'20 XG, '04-'22 XL (except XL883N, XL1200N and XL1200XS), '08-'13 XR, '06-'17 Dyna (except FXDB), '00-later Softail, '09-later Touring (except FLHTKSE and '15-later FLTRU, FLTRX, FLTRXS, FLTRXST and FLTRXSE), and '09-later Trike models. Requires separate purchase of Phone Carrier Mount P/N 76000537 and 76000758.

76001341 **\$39.95**
Fits Harley-Davidson Universal Phone Carrier and Clutch Mount P/N's 76001339 and 76001071 and Harley-Davidson Universal Phone Carrier and Handlebar Mount P/N's 76001340 and 76001072

Model Family Fitment:

- V-ROD ■ SPORTSTER ■ DYNA
- SOFTAIL ■ TOURING



A. UNIVERSAL PHONE CARRIER + CLUTCH MOUNT



A. UNIVERSAL PHONE CARRIER + CLUTCH MOUNT



B. UNIVERSAL PHONE CARRIER + HANDLEBAR MOUNT



B. UNIVERSAL PHONE CARRIER + HANDLEBAR MOUNT

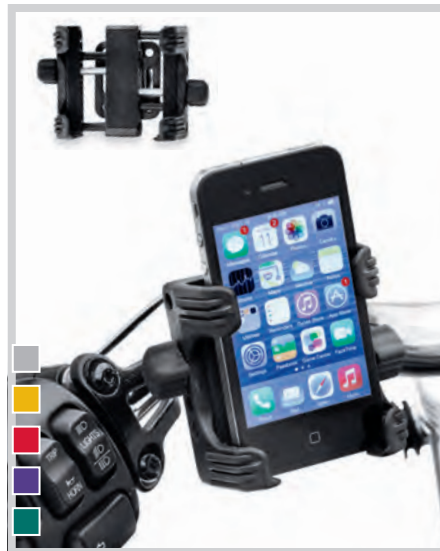

C. UNIVERSAL HANDLEBAR MOUNT PHONE CARRIER (76000549 SHOWN)



C. HARLEY-DAVIDSON UNIVERSAL PHONE CARRIER (76001341 SHOWN)



D. ANTI-VIBRATION MODULE - BLACK



D. ANTI-VIBRATION MODULE - CHROME



E. AUXILIARY POWER PORT - HANDLEBAR MOUNT, CHROME



E. AUXILIARY POWER PORT - HANDLEBAR MOUNT, BLACK



F. AUXILIARY POWER PORT - SADDLEBAG MOUNT



G. AUXILIARY POWER PORT - TOUR-PAK MOUNT '14-LATER MODELS

AUDIO & GAUGES 583

Navigation

D. ANTI-VIBRATION MODULE

Engineered to reduce potential vibration damage to mounted mobile device. Use the Anti-Vibration Module to further reduce vibrations for a variety of frequency ranges. The specially developed elastomer inlay dampens in all directions and reduces up to 60% of vibrations. This not only helps to protect your smartphone from vibrations, but it remains stable and securely mounted so that you can easily navigate while on the road. Fits between device and Harley-Davidson® Universal Phone Carrier. Rugged construction - CNC-machined from 6063 aluminum to be lightweight and durable. 3D vibration damping through specially developed elastomer inlay. Vertical or horizontal orientation. Quick and easy installation.

Fits Harley-Davidson Universal Phone Carrier and Clutch Mount P/N's 76001339 and 76001071 and Harley-Davidson Universal Phone Carrier and Handlebar Mount P/N's 76001340 and 76001072.

76001343	Black.	\$29.95
76001342	Chrome.	\$29.95

E. AUXILIARY POWER PORT - HANDLEBAR MOUNT

Fits '15-'20 XG, '14-'22 XL, '12-'17 Dyna®, '11-later Softail® (except FXDRS, and FXFB and FXFBS models with stock tapered bars), '14-later Road King®, and models with either 1" or 7/8" diameter handlebars. '17-later Road King® requires separate purchase of Electrical Connection Kit P/N 69201599A. '18-later Softail® models require separate purchase of Electrical Connection Kit P/N 69201750.

69200971	Chrome.	\$104.95
69200970	Black.	\$104.95

Fits '12-'17 Dyna, '11-later Softail (except FXDRS, and FXFB and FXFBS models with stock tapered bars), and '14-later Road King models with 1-1/4" diameter handlebars. '17-later Road King requires separate purchase of Electrical Connection Kit P/N 69201599A. '18-later Softail models require separate purchase of Electrical Connection Kit P/N 69201750.

69200855	Chrome.	\$104.95
69200854	Black.	\$104.95

F. AUXILIARY POWER PORT - SADDLEBAG MOUNT

69200091 **\$48.95**
Fits models equipped with 12-volt battery (except FXDRS, VRSC™, XG models, or with Throw-Over or Swingarm Bags). Not for use with accessory Fitted Liners or Premier Liners. Requires separate purchase of Battery Charging Harness P/N 94624-97B, if not already equipped.

G. AUXILIARY POWER PORT - TOUR-PAK® MOUNT.

69200826 **\$45.95**
Fits '14-later FLHTCU, FLHTCUL, FLTRU and FLHTCUTG models. Original Equipment on FLHTK, FLHTKL, FLTRK, and FLHTCUTGSE models.
91671-10 **\$58.95**
Fits '06-'13 FLHTC and FLTRU, '96-'13 FLHTCU and '09-'13 FLHTCUTG models. Also fits '06-'13 Touring models with accessory King Tour-Pak® luggage and '98-'13 Touring models with Tour-Pak mounted rear speaker pods. Not for use with Accessory Fitted Liners or Premier Liner.

Model Family Fitment:

- V-ROD ■ SPORTSTER ■ DYNA
- SOFTAIL ■ TOURING

Notice: The prices appearing in this catalog are the manufacturer's suggested retail prices. Actual retail prices may vary.

Notice: The prices appearing in this catalog are the manufacturer's suggested retail prices. Actual retail prices may vary.

584 AUDIO & GAUGES

Headsets

A. BOOM!™ AUDIO FULL HELMET PREMIUM MUSIC AND COMMUNICATIONS HEADSET

Great-sounding foam-covered stereo earphones comfortably fit into ear pockets in the helmet and the fine wires are easy to hide beneath the helmet liner for a clean installation. The quick-disconnect plug allows you to step away from the motorcycle without removing the helmet and the coiled cord permits freedom of movement in the saddle. The 7-pin DIN plug can be connected to the front and rear communications ports, allowing both rider and passenger access to the music, navigation and voice communications features of your motorcycle and the microphone has been optimized for superior clarity when connected to Harley-Davidson® intercom and Bike-to-Bike communications equipment.

77117-10 **\$201.95**
Fits '98-later FLHT, FLHTCU, FLHTCUSE, FLHTK, FLHTKSE, FLTRU, FLTRUSE and FLHTCUTG models with a Boom!™ Box audio system (except models set up for wireless headsets). Also fits with vehicles equipped with Communication Switch Kit P/N 77173-08 or Boom!™ Audio Music and Intercom Kits.

B. EXTENDED LENGTH COMMUNICATIONS HEADSET CORD

Extended Headset Cord is an essential option for a tall rider or passenger. When compared to the stock headset cord, this cord provides an additional 5" of length at rest and up to 22" of length when fully stretched. The additional length and relaxed twist of the cord reduces the spring effect and the included clothing clip eliminates the tension that can lead to neck fatigue. The 7-pin DIN plug can be connected to the front and rear communications ports, giving both rider and passenger access to the music, navigation and voice communications features of your motorcycle. This cord is a direct plug-in replacement for the standard length headset cord on the Original Equipment headset or the Boom! Audio Full Face Helmet Communications Headset P/N 77117-10.

76000259 **\$49.95**
Fits '10-later Original Equipment Ultra-style Headsets P/N 77147-98A (Domestic) or 77156-98A (HDI), Boom! Audio Full Face Helmet Communications Headset P/N 77117-10 and Half Helmet Headsets P/N 76000145 and 76572-09.

C. HAND-HELD CB MICROPHONE KIT

Comes complete with handlebar mounting bracket and all necessary hardware.

76312-98 **\$183.95**
Fits '98-'13 FLHTC, FLHTCU and FLTRU and '09-'13 FLHTCUTG models. Also fits models equipped with Communication Kits 77107-09, 77108-09A and 77173-08.



A. BOOM! AUDIO FULL HELMET PREMIUM MUSIC AND COMMUNICATIONS HEADSET



A. BOOM! AUDIO FULL HELMET PREMIUM MUSIC AND COMMUNICATIONS HEADSET



B. EXTENDED LENGTH COMMUNICATIONS HEADSET CORD



C. HAND-HELD CB MICROPHONE KIT



D. HIDDEN AM/FM/WB ANTENNA (76000862 SHOWN)



D. HIDDEN AM/FM/WB ANTENNA (76000863 SHOWN)



E SHORTY CB ANTENNA (SHOWN WITH SHORTY AM/FM ANTENNA)



E. SHORTY ANTENNA – AM/FM



F. AM/FM ANTENNA RELOCATION KIT

AUDIO & GAUGES 585

Antennas

D. HIDDEN AM/FM/WB ANTENNA

Hide the AM/FM/WB antenna inside the fairing for a clean, uncluttered look. Uniquely tuned to the Harley-Davidson® radio, this enhanced Hidden Antenna offers reception performance equivalent to the Original Equipment whip antenna and superior to the Shorty Antenna. Perfect for your clean slick custom bagger, this Hidden Antenna is also the ideal addition to models equipped with H-D® Detachables™ Tour-Pak® luggage because it eliminates the need to move the whip antenna back and forth between Tour-Pak luggage and fender mounting locations. Kit includes all required mounting hardware and wiring.

NOTE: Relative antenna performance as compared to stock Original Equipment antenna; results based on reception evaluation conducted in Milwaukee area. Actual performance will be influenced by signal strength and electrical interference in your area. Follow the installation and routing instructions carefully to obtain the best possible performance from the antenna.

76000862 **\$74.95**
Fits '14-later Touring and Trike models with Boom!™ Box Audio System. Separate purchase of Power Extension Harness P/N 69200921 is required if installed with Boom! Bagger Kits P/N 76000410 or P/N 76000411, Boom! Audio Amplifier Kit P/N 76000278 and 76000523, Electric Glo™ Headlamp Trim Rings or Fairing Edge Lights.

76000863 **\$74.95**
Fits '98-'13 Touring and Trike models equipped with AM/FM/WB radio and fairing.

E. SHORTY ANTENNAS

This compact antenna is only 19.0" tall and is a stylish change from the Original Equipment whip antenna. The low-profile antenna simplifies covering the bike for storage. Easy to install, the Shorty Antenna screws on to the factory antenna mount.

76386-09A **\$33.95**
Fits '09-later Touring models equipped with Bike-to-Bike Communication. May require model-specific mounting bracket if installed on a model without a Tour-Pak® carrier.

76386-08 **\$33.95**
Fits '98-'08 Touring models equipped with Bike-to-Bike Communication. May require model-specific mounting bracket if installed on a model without a Tour-Pak carrier.

76388-08 **\$33.95**
Fits '98-later Touring and Trike models equipped with Boom! Box radio.

F. AM/FM ANTENNA RELOCATION KIT

Relocates your AM/FM antenna to the rear fender to accommodate use with an H-D Detachables Two-Up Tour-Pak Mounting Rack. Kit includes mounting bracket, all mounting hardware and wiring harness.

76000582A **\$78.95**
Fits '14-later Touring models (except CVO™) equipped with a Boom!™ Box audio system.

Model Family Fitment:

- V-ROD
- SPORTSTER
- DYNA
- SOFTAIL
- TOURING

Notice: The prices appearing in this catalog are the manufacturer's suggested retail prices. Actual retail prices may vary.

Notice: The prices appearing in this catalog are the manufacturer's suggested retail prices. Actual retail prices may vary.

586 AUDIO & GAUGES

Electrical Accessories

A. USB CHARGING ADAPTOR

Charge your cell phone, MP3 players and other hand-held devices while on the road. Compact Adaptor plugs into standard or accessory 12-volt power ports and provides a standard USB-style outlet that accepts many phone and music player power cords.

69200357 **\$23.95**
For use with Original Equipment or accessory 12V Auxiliary Power Port. Does not fit Electric Vehicles.

B. EXTENDED USB CHARGING ADAPTER – 12V POWER PORT

Available in 36" length. Maximum output: 5V/1A.

69201148 36.0" **\$28.95**
For use with Original Equipment or accessory 12V Auxiliary Power Port. Does not fit Electric Vehicles.

C. 54-AMP HIGH OUTPUT CHARGING SYSTEM

The Harley-Davidson® High Output Charging System is engineered to provide 30% more power than the stock system at idle. With 54 amps of output at 4000 RPM, accessories will operate at their peak performance. This is a recommended installation anytime a multi-amp audio system is installed on the vehicle in order to achieve the full capability of your audio system. It is also recommended when installing heated seats, heated gear and other higher draw powered accessories.

Stock on select CVO™ Touring models, the complete kit includes high performance rotor, stator, voltage regulator and all gaskets and hardware required for installation.

29900028A **\$557.95**
Fits '11-'16 Touring, '10-'16 CVO Touring and '09-'16 Trike models. Stock on '14-'16 FLHTKSE, FLHXSE and FLTRUSE.

D. ELECTRICAL CONNECTION UPDATE KIT*

69201599A **\$39.95**
Fits '18-later Softail® models and '17-later Touring and Trike as a mid-bike connector (near the seat).

69200722 **\$33.95**
Fits '14-'16 Touring and Trike models.

69201750 **\$18.95**
Fits '18-later Softail models as a front-bike connector (near the handlebars).

72673-11 **\$21.95**
Fits '14-'22 XL, '12-'17 Dyna® and '11-'17 Softail models.

E. SWITCHED CIRCUIT ADAPTER HARNESS*

70264-94A **\$23.95**
Fits '94-later Touring and Trike models. Required on '14-later Touring and Trike models when connecting multiple powered accessories using Electrical Connection Kit P/N 69200722, 71400129, or 69201599A.

69201706 **\$28.95**
Fits '18-later Softail models and '17-later Touring and Trike models. Required when connecting the CoolFlow™ Fan and another powered accessory using Electrical Connection Kit P/N 69201599A.

F. ELECTRICAL ACCESSORY ADAPTER*

70270-04A **\$19.95**
Fits '07-later VRSC™, '04-'13 XL and XR, '04-'11 Dyna, '04-'10 Softail and '04-'13 Touring models. Also fits '14-later Touring and Trike when equipped with a third or fourth pair of Boom!™ Audio Stage II speakers.

G. SAE 2-PIN TO USB ADAPTER

69201149 **\$33.95**
Fits H-D® 12V Battery Charging Harnesses. Does not fit Electric Vehicles.

Also available:
SAE 2-PIN Y-HARNESS

69201150 **\$23.95**
Fits H-D 12V Battery Charging Harnesses. Does not fit Electric Vehicles.

*NOTE: It is possible to overload your motorcycle's charging system by adding too many electrical accessories. If your combined electrical accessories operating at any one time consume more electrical current than your vehicle's charging system can produce, the electrical consumption can discharge the battery and cause vehicle electrical system damage. Ask your dealer for advice about the amount of current consumed by additional electrical accessories.



A. USB CHARGING ADAPTOR



B. EXTENDED USB CHARGING ADAPTER – 12V POWER PORT



C. 54-AMP HIGH OUTPUT CHARGING SYSTEM



D. ELECTRICAL CONNECTION UPDATE KIT – (69201599A SHOWN)



E. SWITCHED CIRCUIT ADAPTER HARNESS

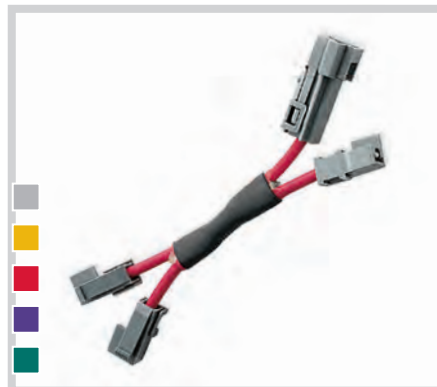

F. ELECTRICAL ACCESSORY ADAPTER



G. SAE 2-PIN TO USB ADAPTER



H. COMBINATION ANALOG SPEEDOMETER/TACHOMETER – 5" SPUN ALUMINUM DIAL



H. COMBINATION ANALOG SPEEDOMETER/TACHOMETER – 5" BLACK DIAL



I. DIGITAL SPEEDOMETER/ANALOG TACHOMETER – 4" SPUN ALUMINUM DIAL



AUDIO & GAUGES 587

Speedometers/Tachometers

COMBINATION SPEEDOMETER/TACHOMETER

Maintain the clean view over the handlebar. This unique Combination Speedometer/Tachometer allows you to monitor engine speed without adding handlebar-mounted gauges. The unit mounts in the stock dash opening and is a direct plug-in installation. The backlit gauges include a large LCD (liquid crystal display) information screen that displays odometer/trip meter data, miles-to-empty readings, an easy-to-read segmented fuel display, a gear position indicator, clock and on '20-later Road King models Traction Control, Rain Mode, Hill Hold and TPMS icons where available. This valuable information is available to the rider at a glance. The gauge features push-button adjustable backlighting with over 600 color tone options, allowing the rider to adjust pointer, LCD and backlighting colors to match any paint scheme or viewing preference.

NOTE: As a result of different Original Equipment capabilities, the following exceptions apply: Traction Control, Rain Mode, Hill Hold and TPMS functions are only available on '20-later Road King® models. Gear position not available on '04-'07 models, Fuel functions are not available on '04-'06 XL, '04-'08 Dyna®, '04-'07 Softail® and '04-'07 Road King® models. Gauges feature speedometer and tachometer pointers that sweep clockwise to provide a "gauge within a gauge" look. Kit includes a data transfer cable to easily upload initial mileage at time of installation.

H. ANALOG SPEEDOMETER/TACHOMETER – 5"

Gauges feature speedometer and tachometer pointers that sweep clockwise to provide a "gauge within a gauge" look. Kit includes a data transfer cable to easily upload initial mileage at time of installation.

Fits '12-'17 Dyna, '11-'17 Softail® (except '11-'12 FLSTSE) and '14-later FLHR, FLHRC and FLHRXS models with a 5.0" Speedometer.

74774-11D	Spun Aluminum Dial, MPH.	\$342.95
74775-11C	Spun Aluminum Dial, KPH.	\$342.95
74776-11D	Black Dial, MPH.	\$342.95
74777-11C	Black Dial, KPH.	\$342.95

Fits '04-'11 Dyna, '04-'10 Softail (except FLSTSE) and '04-'13 Road King models (except '07-'08 FLHRSE) equipped with a 5" Speedometer.

70900070B	Spun Aluminum Dial, MPH.	\$342.95
70900071A	Spun Aluminum Dial, KPH.	\$342.95
70900072A	Spun Aluminum Dial, MPH/KPH.	\$342.95

I. DIGITAL SPEEDOMETER/ANALOG TACHOMETER – 4"

The digital speed reading can be easily toggled between MPH and KPH to simplify cross-border travel. Mileage re-statement resides in the vehicle ECM so initial mileage will be uploaded at the time of installation.

70900475 Spun Aluminum Dial, MPH/KPH. **\$351.95**
U.S. models. Fits '14-'22 XL, '12-'17 Dyna and '11-'17 Softail models equipped with 4" speedometer. XL models require separate purchase of Fuel Sensor Kit P/N 61200008A to make use of the fuel level and range function.

70900100C Spun Aluminum Dial, MPH/KPH. **\$342.95**
Non-U.S. models. Fits '14-'22 XL, '12-'17 FXDB and FXDWG, '11-'17 FXCWC, FXS and FXSB models equipped with 4" speedometer. XL models require separate purchase of Fuel Sensor Kit P/N 61200008A to make use of the fuel level and range function.

70900274 Spun Aluminum Dial, MPH/KPH. **\$342.95**
Worldwide Models. Fits '04-'13 XL (except XR, XL50 and '04-'08 XL1200R), '04-'11 Dyna models with 4" speedometer and '08-'10 FXCW and FXCWC models. '07-'13 XL models require separate purchase of Fuel Sensor Kit P/N 61200008A to make use of the fuel level and range function. Does not fit XL883 models equipped with Screamin' Eagle® 1200cc Stage I Conversion Kit P/N 29784-07 and 30003-10.

Also available:

FUEL LEVEL SENSOR KIT

In-tank sending unit employs capacitive sensing technology to accurately monitor the fuel level and relays the information to the Speedo/Tach LCD display for at-a-glance viewing. Kit includes sending unit, wiring harness and all necessary installation hardware.

61200008A **\$149.95**
Fits '07-'22 XL models equipped with Combination Digital Speedometer/Analog Tachometer P/N 70900274, 70900100C or 70900475.

Notice: The prices appearing in this catalog are the manufacturer's suggested retail prices. Actual retail prices may vary.

Notice: The prices appearing in this catalog are the manufacturer's suggested retail prices. Actual retail prices may vary.

AUDIO & GAUGES

588 AUDIO & GAUGES

Gear Indicator & Gauges

A. SPUN ALUMINUM FACE SPEEDOMETER

Add a touch of luxury and style to your dash. First featured on the '04 Screamin' Eagle® Deuce™ and Electra Glide® motorcycles, these spun aluminum metal-faced gauges offer a rich contrast to a chrome console or black inner fairing surface. The gauges feature subtle Harley-Davidson® racing orange backlighting for a unique nighttime look. Mileage reinstatement is available through your Dealer.

Fits '04-'06 FXDWG, '06 FXD35, '07 FXDC and '04-'06 Softail® and Road King® models.

67313-05A 5" Speedometer – MPH. **\$237.95**

67315-05A 5" Speedometer – KPH. **\$237.95**



A. SPUN ALUMINUM FACE SPEEDOMETER

B. DIGITAL GEAR INDICATOR

What gear am I in right now? Eliminate the guesswork with a Digital Gear Indicator. Conveniently located on the handlebar for line-of-sight viewing, the bright LED display is easy to read with a quick glance. When the clutch is out, the display indicates the current gear 1-6 or a large N when the transmission is in the neutral position. Easy to install, this plug and play Gear Indicator requires no wire splicing or complicated programming. A built-in photocell automatically adjusts the display for improved visibility in direct sunlight and dims the display at night to reduce distraction. Available in satin black finish. The complete kit includes a self-contained LED and control module, control housing, wiring harness and required mounting hardware. Switch housing can accept one additional auxiliary switch (sold separately).

70900078 Satin Black. **\$235.95**

Fits '07-'17 VRSC™ (except VRSCF), '07-'13 XL and XR, '07-'11 Dyna®, '07-'10 Softail and '07-'13 Touring models. '07-'08 XL1200 models require update calibration. Does not fit XL883 models equipped with Screamin' Eagle® 1200CC Stage I Conversion Kits P/N 29784-07 and 30003-10. Also, does not fit with Boom!™ Audio Cruiser Amp and Speaker Kits P/N 76262-08A, 76320-08A or 76321-09A.



B. DIGITAL GEAR INDICATOR – SATIN BLACK



C. TACH KIT FOR SPORTSTER® MODELS

Upgrade your XL883 to dual instruments. The kit includes an electronic tachometer, wrinkle-black dual gauge mounting bracket and hardware required for installation. Tachometer graphics complement Original Equipment speedometer and brackets allow for installation of your stock indicator lights.

67182-07 **\$357.95**

Fits '07-'08 XL883, '07-'10 XL883L and '07 XL883R models. Stock on '07-'08 XL1200R models.



C. TACH KIT FOR SPORTSTER MODELS



Model Family Fitment:

V-ROD
 SPORTSTER
 DYNA
 SOFTAIL
 TOURING

Notice: The prices appearing in this catalog are the manufacturer's suggested retail prices. Actual retail prices may vary.

AUDIO & GAUGES 589

Fairing Mount Gauges

D. CUSTOM FACE GAUGES

Add a rich, custom look to your dash. First featured on the '14-'15 CVO™ models, these chrome-accented gauges feature backlighting and large, easy-to-read numbers for at-a-glance viewing. Gauges are plug-in ready and require no additional splicing or re-wiring for installation. Mileage reinstatement is available through your Dealer.

Fits '14-'19 Electra Glide®, Road Glide®, Street Glide® and Ultra Limited models. Original Equipment on some CVO™ models.

70900773B Speedo/Tach Cluster – MPH. **\$368.95**

70900777B Speedo/Tach Cluster – KPH. **\$368.95**

70900778B Speedo/Tach Cluster – MPH/KPH. **\$368.95**

70900774 Fuel Gauge. **\$119.95**

70900775 Voltmeter. **\$119.95**



D. CUSTOM FACE GAUGES

E. SPUN ALUMINUM FACE GAUGES

Add a touch of luxury and style to your dash. First featured on the '04 Screamin' Eagle® Deuce™ and Electra Glide models, these Spun Aluminum Face Gauges offer a rich contrast to a chrome console or black inner fairing surface. The gauges feature subtle Harley-Davidson® racing orange backlighting for a unique nighttime look. Mileage reinstatement is available through your Dealer.

67516-08 4" Speedometer – MPH. **\$237.95**
Fits '08-'13 Electra Glide and Road Glide models equipped with 4" gauges.

67516-04B 4" Speedometer – MPH. **\$237.95**
Fits '04-'07 Electra Glide and Road Glide models equipped with 4" gauges.

74552-04A Voltmeter. **\$95.95**

75113-04A Fuel Gauge. **\$104.95**

Fits '04-'07 Electra Glide and Road Glide models.

75113-08 Fuel Gauge. **\$104.95**

Fits '08-'13 Electra Glide and Road Glide models.

74553-04A Oil Pressure Gauge. **\$95.95**

Fits '04-'13 Electra Glide, Road Glide and Trike models. FLHT and FLHTI models require purchase of additional service parts for installation. See your Dealer for details.

74554-04 Air Temperature Gauge. **\$59.95**

Fits '04-'13 Electra Glide, Road Glide and Trike models. FLHT and FLHTI models require purchase of additional service parts for installation. See your Dealer for details.



E. SPUN ALUMINUM FACE GAUGES

F. TITANIUM FACE GAUGES

Add a rich, custom look to your dash. First featured on the '10 FLHTK Ultra Limited model, these black and icy cool titanium numbered gauges feature white backlighting and large, easy-to-read numbers for at-a-glance viewing. Gauges are plug-in ready and require no additional splicing or re-wiring for installation. Mileage reinstatement is available through your Dealer.

Fits '08-'13 Touring (except Road King®) and Trike models.

74682-10 4" Speedometer – MPH. **\$201.95**

74683-10 4" Speedometer – KPH. **\$201.95**

74692-10 4" Tachometer. **\$170.95**

74688-10 Fuel Gauge. **\$78.95**

74689-10 Air Temperature Gauge. **\$74.95**

74690-10 Oil Pressure Gauge. **\$74.95**

74691-10 Voltmeter. **\$74.95**

70900176 Oil Temperature – Fahrenheit. **\$164.95**



F. TITANIUM FACE GAUGES

Model Family Fitment:

V-ROD
 SPORTSTER
 DYNA
 SOFTAIL
 TOURING

Notice: The prices appearing in this catalog are the manufacturer's suggested retail prices. Actual retail prices may vary.

AUDIO & GAUGES

590 AUDIO & GAUGES

Fairing Mount Gauges

A. GAUGE VISOR RING

A touch of chrome makes all the difference. These easy-to-install trim rings feature an integrated eyebrow visor to shield the gauge face from the sun's glare. Self-adhesive backing for secure mount.

74661-04 5.0" Gauge. **\$42.95**
Fits '12-'16 FLD, '99-'08 FXDWG, '15-'17 FXDF, '99-'17 Softail® (except FLSTFSE, FLSTNSE, FXCW, FXCWC, FXS, FXSB, FXSBSE, FXSE, FXST-Aus, FXSTD and models equipped with Chrome Console P/N 67575-04), '18-later FLFL, FLDE, FLHC and FLHCS and '99-'07 Road King® models.



A. GAUGE VISOR RING – 5" GAUGE



B. INSTRUMENT GAUGE BEZEL

A touch of chrome makes all the difference. These bezel covers take just seconds to install and add the beauty of chrome to your dash. Available to fit all the fairing-mount gauges, these easy-to-install, chrome-plated formed rings feature peel-and-stick adhesive backing for permanent installation.

74541-00 4.0" Gauge. **\$20.95**
Fits Speedometer and Tachometer Gauges on '00-'22 XL, '00-'13 Dyna® (except FLD and FXDWG), '13-'17 FXSB, FXSBSE and FXST-Aus and '00-'13 Electra Glide®, Street Glide®, Road Glide® and Trike Models (sold individually).



B. INSTRUMENT GAUGE BEZEL – 4" GAUGE



C. OIL PRESSURE GAUGE KIT

Check your oil pressure at a glance with this oil-filled Pressure Gauge Kit, specifically designed to look good, fit right and perform properly on your Twin Cam-equipped motorcycle. The custom mounting brackets have been polished and chrome-plated to rigid Harley-Davidson standards and the gauge offers premium reliability. The kit includes all necessary hardware and mounting brackets for quick and clean installation.

75133-99 **\$160.95**
Fits '99-'05 Dyna, '00-'17 Softail, '99-'13 FLHR and '99-'05 FLHT models. Does not fit with Billet Rocker Box Cover P/N 17658-03.



C. OIL PRESSURE GAUGE KIT



D. LIQUID-FILLED OIL PRESSURE GAUGE

Contains special non-yellowing fluid that dampens the internal movement for improved gauge reliability. Incorporates corrosion-resistant stainless steel graphics that match various late model instruments. Complete with chrome-plated steel fittings and O-rings for crankcase installation. New mounting design prevents damage from improper installation.

75012-82D **\$74.95**
Fits '82-'84 Shovelhead and '84-later Evolution® 1340-equipped models.



D. LIQUID-FILLED OIL PRESSURE GAUGE



E. OIL TEMPERATURE GAUGE – FAIRING MOUNT

Keep a close eye on your engine's vital signs. This 2.0" diameter gauge monitors engine oil temperature to provide an early warning of conditions that may require attention. The gauge face is styled to complement Original Equipment fairing mount gauges. Complete kit includes gauge, installation hardware and wiring harness.

Fits '99-'13 FLHT, FLHTC, FLHTCU, FLHX, FLTR and Trike models. Does not fit '09-later CVO™ models.

1. 70900284 Silver Face – Fahrenheit. **\$160.95**
2. 70900283 Black Face – Fahrenheit. **\$160.95**

Fits '08-'13 Touring models (except Road King) and Trike models.

3. 70900176 Titanium Face – Fahrenheit. **\$164.95**



E. OIL TEMPERATURE GAUGE – FAIRING MOUNT

Model Family Fitment:

- V-ROD
- SPORTSTER
- DYNA
- SOFTAIL
- TOURING

Notice: The prices appearing in this catalog are the manufacturer's suggested retail prices. Actual retail prices may vary.

AUDIO & GAUGES 591

Fuel Caps

F. FLUSH-MOUNT FUEL CAPS

Emphasize the long and lean look of the fuel tank. This Flush-Mount Fuel Cap Kit offers a pop-up filler design that replaces the Original Equipment twist-on fuel cap. A simple push and the fuel filler cap pops up to provide ample grip, even while wearing gloves. Easy to install, the cap assembly screws into position and the self-adhesive decorative ring finishes the look. Complete kit includes screw-in mount, pop-up cap and matching trim ring.

Fits '22-later FLFBS, FLHCS, FXLRS, FXLRST and FXRST and '23-later FXBR models.

61100210 Chrome. **\$85.95**
61100211 Gloss Black. **\$85.95**

Fits '18-later FXBB, FXBBS, FXBRS and FXST, and '18-'20 FXBR models.

61100133 Chrome. **\$84.95**
61100134 Gloss Black. **\$84.95**

Fits '18-later FXFB and FXFBS models.

61100136 Gloss Black. **\$84.95**

Fits '19-'20 FXDRS models.

61100158 Gloss Black. **\$107.95**

Fits '98-'22 XL models equipped with 3.3 gal (12.5 L) fuel tank.

63133-10B Chrome. **\$84.95**
63134-10B Gloss Black. **\$84.95**

Fits '98-'22 XL models equipped with 2.1 gal (7.9 L) or 4.5 gal (17.0 L) fuel tank. Does not fit '04-'10 XL1200C models.

63139-10B Chrome. **\$84.95**
63140-10B Gloss Black. **\$84.95**

Fits '21-later FLHXS, FLTRXS and FLTRXSE and '22-later FLHXST and FLTRXST models. Also Fits '11-'17 FLSTNSE, FXS, FXSB, FXSBSE and FXSE models.

61100006B Chrome. **\$84.95**
61100007B Gloss Black. **\$84.95**

G. FLUSH-MOUNT FUEL CAP AND LEFT SIDE TANK CAP KIT

Emphasize the long and lean look of the fuel tank. This Flush-Mount Fuel Cap and Left Side Tank Cap Kit offers a pop-up filler design that when installed and sealed looks identical to the flush mount cap.

Fits '18-'21 FLDE, FLFB, FLFBS, FLHC, FLHCS, FLSE, FLSL, FXLR, FXLRS and FXLRST models.

61100131 Chrome. **\$129.95**
61100132 Gloss Black. **\$129.95**

H. CUSTOM FUEL CAP AND LEFT SIDE FUEL TANK CAP – SKULL

Fits '92-'22 XL, '92-'17 Dyna® (except '04-later FXD and FXDX, '05-'06 FXDC and '07 FXDSE), '00-later Softail®, (except '18-later FXFB and FXFBS, FXSTD and '07-'08 FXSTSE), '94-later Road King® and '15-later Freewheeler® models. Does not fit models equipped with Original Equipment locking or tethered fuel caps. Use on '13-'14 FXSBSE requires removal of stock flush mount trim ring.

61100103A Fuel Cap – Gloss Black. **\$64.95**
61100125A Fuel Cap – Chrome. **\$64.95**

Fits '18-'21 Softail models (except FXBB, FXBBS, FXBR, FXBRS, FXDRS, FXFB and FXFBS).

57300216 Left Trim – Black. **\$54.95**
57300149 Left Trim – Chrome **\$54.95**

I. BAR & SHIELD LOGO SELF-LOCKING FUEL CAP

Functional and stylish, these polished, chrome-plated caps feature a convenient self-locking mechanism and a stamped Harley-Davidson Bar & Shield logo on the key hole cover. Maintains the same features as the Original Equipment fuel cap. The kits come complete with two keys.

Fits '92-'22 XL, '92-'17 Dyna (except '04-later FXD and FXDX, '05-'06 FXDC and '07 FXDSE), '00-later Softail, (except FXSTD and FXSTSE) '94-later Road King, '21-later FLHXS and FLTRXS, '22-later FLHXST and FLTRXST and '15-later Freewheeler models. Does not fit models equipped with Original Equipment locking or tethered fuel caps. Use on '13-'14 FXSBSE, '21-later FLHXSE and FLTRXSE requires removal of stock flush mount trim ring.

61100117A Gloss Black. **\$64.95**
61100129A Chrome. **\$64.95**

Notice: The prices appearing in this catalog are the manufacturer's suggested retail prices. Actual retail prices may vary.



F. FLUSH-MOUNT FUEL CAP – CHROME



F. FLUSH-MOUNT FUEL CAP – BLACK



G. FLUSH-MOUNT FUEL CAP AND LEFT SIDE TANK CAP KIT – CHROME



H. CUSTOM FUEL CAP AND LEFT SIDE FUEL TANK CAP – SKULL, GLOSS BLACK



H. CUSTOM FUEL CAP AND LEFT SIDE FUEL TANK CAP – SKULL, CHROME

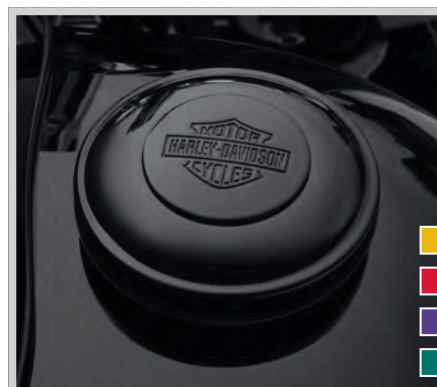

I. BAR & SHIELD LOGO SELF-LOCKING FUEL CAP – GLOSS BLACK



I. BAR & SHIELD LOGO SELF-LOCKING FUEL CAP – CHROME

592 AUDIO & GAUGES

Fuel Caps & Gauge

A. CUSTOM FUEL CAPS

Add a custom touch to your tank. Styled to reflect your attitude, these elegantly constructed fuel caps are the perfect match for your ride. The fuel cap is easy to install and features a ratcheting design to ensure that the design faces the correct direction.

Fits '92-'22 XL, '92-'17 Dyna® (except '04-later FXD and FXDX, '05-'06 FXDC and '07 FXDSE), '00-later Softail®, (except FXSTD and FXSTSSE) '94-later Road King®, '21-later FLHXS and FLTRXS, '22-later FLHXST and FLTRXST and '15-later Freewheeler® models. Does not fit models equipped with Original Equipment locking or tethered fuel caps. Use on '13-'14 FXSBSE, '21-later FLHXSE and FLTRXSE requires removal of stock flush mount trim ring.

61100107A	Dominion™ Black.	\$99.95
61100106	Dominion Bronze.	\$107.95
61100093B	Gloss Black.	\$38.95
61100126A	Diamond Black.	\$63.95
61100180	Machine Cut.	\$116.95

Also available:

LEFT SIDE FUEL TANK CAPS

Styled to match the custom right-side fuel cap, this left-side decorative tank cap proudly completes your custom look. The easy-to-install cap replaces the Original Equipment trim, and provides the rider with a symmetrical view over the tank.

Fits '18-'21 Softail models (except FXBB, FXBBS, FXBR, FXBRS, FXDRS, FXFB and FXFBS).

57300186	Dominion Black.	\$95.95
57300236	Gloss Black.	\$38.95
57300165	Brass Collection.	\$129.95
57300151	Diamond Black.	\$54.95



A. CUSTOM LEFT & RIGHT FUEL CAPS – DOMINION BLACK



A. CUSTOM FUEL CAP – GLOSS BLACK



A. CUSTOM FUEL CAP – DIAMOND BLACK

Model Family Fitment:

- V-ROD
- SPORTSTER
- DYNA
- SOFTAIL
- TOURING

Notice: The prices appearing in this catalog are the manufacturer's suggested retail prices. Actual retail prices may vary.

AUDIO & GAUGES 593

Fuel Caps & Gauges

B. LED FUEL GAUGES*

This low-profile fuel gauge replaces the analog readout with bright LED lamps. The six edge-mounted LED lamps glow blue when the tank is full and extinguish one by one as fuel is consumed. Plug-in installation without splicing. Photocell automatically adjusts LED brightness for improved visibility in direct sunlight and dims at night to avoid distraction.

Fits '09-'17 Dyna® (except FXD), '08-'17 Softail® (except FLSTNSE, FXCW, FXCWC, FXS, FXSB, FXSBSE and FXSE), '08-'17 Road King® and '15-'17 Freewheeler® models.

75098-08A	Chrome Skull.	\$180.95
70900781	Black Skull.	\$180.95
75358-10A	Diamond Black.	\$160.95
70900709	Brass.	\$235.95

Fits '04-'08 FXD35, FXDB, FXDF, FXDL and FXDWG, '07-'08 FXDC, '04-'07 Softail, '01-'03 EFI Softail (except FXSTD), '03-'07 Road King and '01-'02 EFI Road King models.

75357-10A	Diamond Black.	\$160.95
------------------	----------------	-----------------

*Some local regulations prohibit using colored lights during vehicle operation on public streets. May not conform to local lighting regulations.

C. FLUSH-MOUNT FUEL CAP AND GAUGE KIT*

Emphasize the long and lean look of the fuel tank. This Flush-Mount Fuel Cap and Gauge Kit offers a pop-up filler design that when installed and sealed looks identical to the flush gauge. A simple push and the fuel filler cap pops up to provide ample grip, even while wearing gloves. The flush fuel gauge features individual LED lamps that shine through a mirror-coated glass that glows when the ignition is switched on. A photocell automatically adjusts LED brightness for improved visibility in direct sunlight and dims at night to avoid distraction. Complete kit includes fuel cap, fuel gauge, trim ring and plug-in wiring harness.

Fits '09-'17 Dyna models (except FXD).

75327-09D	Gloss Black.	\$225.95
------------------	--------------	-----------------

Fits '04-'08 FXD35, FXDB, FXDL and FXDWG and '07-'08 FXDC and FXDF models.

62910-06D	Chrome.	\$225.95
------------------	---------	-----------------

Fits '08-'17 Softail (except FLSTNSE, FXCW, FXCWC, FXS, FXSB, FXSBSE and FXSE), '08-'19 Road King and '15-'19 Freewheeler models.

62823-08D	Chrome.	\$225.95
------------------	---------	-----------------

75027-08D	Gloss Black.	\$225.95
------------------	--------------	-----------------

Fits '04-'06 carbureted and '01-'07 fuel injected Softail models (except FXSTD/I).

62818-06G	Chrome.	\$225.95
------------------	---------	-----------------

75014-06D	Gloss Black.	\$225.95
------------------	--------------	-----------------

Fits '04-'07 Road King models.

62823-06D	Chrome.	\$225.95
------------------	---------	-----------------

*Some local regulations prohibit using colored lights during vehicle operation on public streets. May not conform to local lighting regulations.



B. LED FUEL GAUGE – CHROME SKULL



B. LED FUEL GAUGE – BLACK SKULL



B. LED FUEL GAUGE – DIAMOND BLACK



B. LED FUEL GAUGE – BRASS



C. FLUSH-MOUNT FUEL CAP AND GAUGE KIT – CHROME



C. FLUSH-MOUNT FUEL CAP AND GAUGE KIT – GLOSS BLACK

Model Family Fitment:

- V-ROD
- SPORTSTER
- DYNA
- SOFTAIL
- TOURING

Notice: The prices appearing in this catalog are the manufacturer's suggested retail prices. Actual retail prices may vary.



Ultra Limited - Signature LED Rear Lighting

HARLEY-DAVIDSON®

LIGHTING

See and be seen. With Harley-Davidson Genuine Motorcycle Parts & Accessories headlamps, brake lights and auxiliary lighting, you get improved visibility in front of you and more attention from all around you.

596 LIGHTING

LED Decorative Lighting

A. SPECTRA GLO™ LED LIGHTING CONTROLLER KIT*

Nothing draws attention at the curb like a well-lighted bike. Whether you are looking for a rich neon glow or a pulsing crowd pleaser, the Harley-Davidson® Spectra Glo™ Lighting System brings ultra-bright LED lighting to your ride. The Spectra Glo System utilizes RGB LED technology to produce over 500 shades of brilliant color, all controllable with a waterproof handheld wireless fob. Simply use one button to select one of the 7 base colors, and then dial in the shade you desire. You can choose to match the color of your bike, or add a contrasting tone from the wide spectrum of colors. Once you select a color, you can choose between solid, flash or fade modes with a tap of the remote control.

At the core of the Spectra Glo system is the Lighting Controller. The compact waterproof controller box is hidden beneath the seat, and is activated with the included wireless remote fob. The Lighting Controller is the hub for all the added Spectra Glo light options, and syncs the color and mode selection between all the LEDs. Designed specifically for Harley-Davidson motorcycles, the controller will not interfere with the bike's electronics. The low draw LED lamps have a one-hour auto-shutoff feature to preserve the battery. Kit includes Controller, Remote Control Fob with battery and plug-in wiring harness.

68000218 **\$107.95**

Required for use with Spectra Glo components. '18-later Softail® and '17-later Touring models require purchase of Vehicle Connection Kit P/N 69201526. All other vehicles require purchase of Vehicle Connection Kit P/N 69201636.



A. SPECTRA GLO LED LIGHTING CONTROLLER KIT – FOB



SPECTRA GLO LIGHTING (RED SETTING SHOWN)



SPECTRA GLO LIGHTING (GREEN SETTING SHOWN)

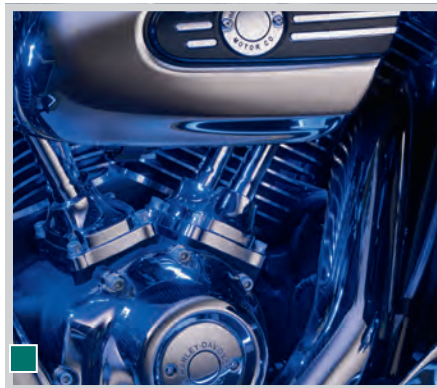

SPECTRA GLO LIGHTING (BLUE SETTING SHOWN)



SPECTRA GLO LIGHTING (AMBER SETTING SHOWN)

*NOTE: Some local regulations prohibit using colored or indirect lighting during vehicle operation on public streets. Check local regulations before installation.

Model Family Fitment:

- V-ROD
- SPORTSTER
- DYNA
- SOFTAIL
- TOURING

Notice: The prices appearing in this catalog are the manufacturer's suggested retail prices. Actual retail prices may vary.

LIGHTING 597

LED Decorative Lighting

B. SPECTRA GLO™ LED LIGHT POD KIT*

Light Pods allow you to install general lighting almost anywhere on the bike. Ground-facing pod placement provides a neon-like pool of light on the pavement, and pods hidden below the tank or behind covers reflect into chrome surfaces to double the splash of color. These compact flexible pods feature connectors that allow the lights to be chained together in longer strips or placed individually and connected by jumper wires. Each pod features 3 individual RGB LEDs, and includes a tough adhesive backing for easy placement. Begin the installation with the 6-Lamp Starter Kit, and add on with one or more 4-Lamp Expansion Kits. Starter Kit includes 6 light pods, 4 – 3" jumpers, 1 – 8" jumper and 1 – 24" jumper. Expansion Kit includes 4 light pods, 3 – 3" jumpers, and 1 – 8" jumper.

68000213 6-Lamp Starter Kit. **\$160.95**
Fits all models. (except RA1250, RA1250S and RH1250). Requires separate purchase of Controller P/N 68000218. Additional alternate length harnesses are available (sold separately).

68000214 4-Lamp Expansion Kit. **\$107.95**
Fits all models equipped with an Spectra Glo™ Light Pod Kit. Additional alternate length harnesses are available (sold separately).

Also available: (not shown)

SPECTRA GLO WIRE HARNESS KIT
Required for installation of Spectra Glo Lighting System on specified models.

69201636 **\$31.95**

Required for installation of Spectra Glo Lighting System on all models (except '17-later Touring® and Trike, '18-later Softail®, '20-later LiveWire® and all Revolution® Max equipped models.)

Also available: (not shown)

SPECTRA GLO LIGHTING WIRING JUMPERS

These wiring harnesses are custom made for easy plug-and-play installation of Spectra Glo Light Pods. Plan your installation, and select the matching harness lengths to allow placement of light pods throughout the vehicle. No cutting or splicing is required.

Works with Spectra Glo Light Pod Base and Expansion Kits.

69201525	3" Jumper Harness.	\$11.95
69201529	8" Jumper Harness.	\$18.95
69201530	24" Jumper Harness.	\$23.95
69201595	24" Jumper with Grommet.	\$23.95
69201625	48" Jumper Harness.	\$28.95
69201594	Y-Harness.	\$23.95



B. SPECTRA GLO LED LIGHT POD KIT (RED SETTING SHOWN)



B. SPECTRA GLO LED LIGHT POD KIT (GREEN SETTING SHOWN)



B. SPECTRA GLO LED LIGHT POD KIT (BLUE SETTING SHOWN)



B. SPECTRA GLO LED LIGHT POD KIT (ORANGE SETTING SHOWN)



B. SPECTRA GLO LED LIGHT POD KIT – 6-LAMP STARTER KIT



B. SPECTRA GLO LED LIGHT POD KIT – 4-LAMP EXPANSION KIT

*NOTE: Some local regulations prohibit using colored or indirect lighting during vehicle operation on public streets. Check local regulations before installation.

Model Family Fitment:

- V-ROD
- SPORTSTER
- DYNA
- SOFTAIL
- TOURING

Notice: The prices appearing in this catalog are the manufacturer's suggested retail prices. Actual retail prices may vary.

LIGHTING

598 LIGHTING

LED Decorative Lighting

A. ELECTRA GLO™ ILLUMINATED FAIRING ACCENT TRIM

Sweeping trim dresses the Electra Glide® Batwing Fairing for a distinctive, yet functional look. The contour-hugging spear and smoked lenses hide LED lamps that glow white as running lamps when the ignition is on and function as auxiliary amber sequential directional indicators when the turn signals are activated. The wiring is concealed inside the fairing for a clean, custom appearance. Complete kit includes mounting template and all necessary installation hardware. Trim may cover pinstripes or two-tone paint lines on some vehicles. Check appearance prior to installation.

Fits '14-later Electra Glide®, Street Glide®, Ultra Limited, and Tri Glide® models. Fitment on vehicles with two-tone paint, pinstriped, or CVO™ models is not recommended due to the potential for the accent lights to overlap pinstripes or paint lines.

68000191A Gloss Black . **\$319.95**
68000190A Chrome. **\$319.95**



A. ELECTRA GLO ILLUMINATED FAIRING ACCENT TRIM – RUNNING LIGHT

B. ELECTRA GLO™ FAIRING EDGE LIGHT KIT

Amplify your ride. The Electra Glo™ Fairing Edge Light kit adds forward-facing white LED accent lights to the front profile of your bike. Formed to follow the contour of the batwing fairing, the slim strip of lamps adds a strong visual element to the iconic shape of the Electra Glide model. The electrifying appearance adds conspicuity to get you noticed and the smoked housing conceals the lights and blends into the background when switched off. Simple “plug in” connections with no cutting or splicing of wires required.

68000104 **\$116.95**
 Fits '14-later Electra Glide, Street Glide, Ultra Limited and Tri Glide models. Separate purchase of Power Extension Harness P/N 69200921 is required if installed with Hidden AM/FM/WB Antenna P/N 76000513 or Electra Glo Light Rings.



A. ELECTRA GLO ILLUMINATED FAIRING ACCENT TRIM – TURN SIGNAL

C. ELECTRA GLO ILLUMINATED WINDSHIELD TRIM

Smoked lenses hide bands of amber LED lamps that glow as running lamps when the ignition is on, and the two outer clusters function as auxiliary directional indicators when the turn signals are activated. The wiring is concealed inside the fairing for a clean, custom appearance. Complete kit includes all necessary mounting hardware.

Fits '14-later Electra Glide, Street Glide, Ultra Limited and Tri Glide models. Installation on CVO models requires removal of current windshield trim. Not for use with Three-Pocket Fairing Pouch P/N 93300054B.

57000394A Chrome. **\$221.95**
57000395A Gloss Black. **\$221.95**



B. ELECTRA GLO FAIRING EDGE LIGHT KIT



C. ELECTRA GLO ILLUMINATED WINDSHIELD TRIM

Model Family Fitment:

- V-ROD
- SPORTSTER
- DYNA
- SOFTAIL
- TOURING

Notice: The prices appearing in this catalog are the manufacturer's suggested retail prices. Actual retail prices may vary.

LIGHTING 599

DAYMAKER® LED LIGHTING

Daymaker® LED Projector Headlamps were developed to provide light where you need it most. With a combination of superior nighttime performance and modern signature styling, these brilliant LED headlamps push out a bright-white beam that lights up the surroundings and draws the attention of oncoming traffic. The long-life, solid-state LED headlamps are housed in sealed shock and vibration-resistant lamp assemblies that mount into the existing light housing. Installation is simple, and the plug-in headlamps require no rewiring.

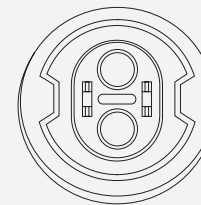

7" DAYMAKER PROJECTOR LED HEADLAMP

Offering best-in-class punch of light, these headlamps illuminate the road in front of you, yet are directed slightly downward to avoid blinding oncoming drivers, making them perfect for highway riding situations.

- Extensive engineering and testing to ensure the road in front of you is equally lit
- No dark spots or streaks in light illumination
- Plug and play headlamps can be installed easily

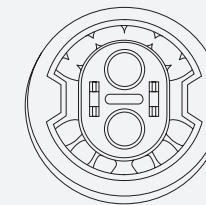

7" DAYMAKER ADAPTIVE LED HEADLAMP

Delivering the right amount of usable light exactly where you need it most – you will see ditch to ditch, and down the road with lean angle controlled bank lighting for improved line of sight through corners.

- Includes all features and benefits of the 7" Daymaker Projector LED Headlamp
- Automatically projects light into corners to illuminate areas of previously unlit road
- Patented sensors and electronics determine lean angle of the motorcycle
- Adaptive technology works in both low beam and high beam

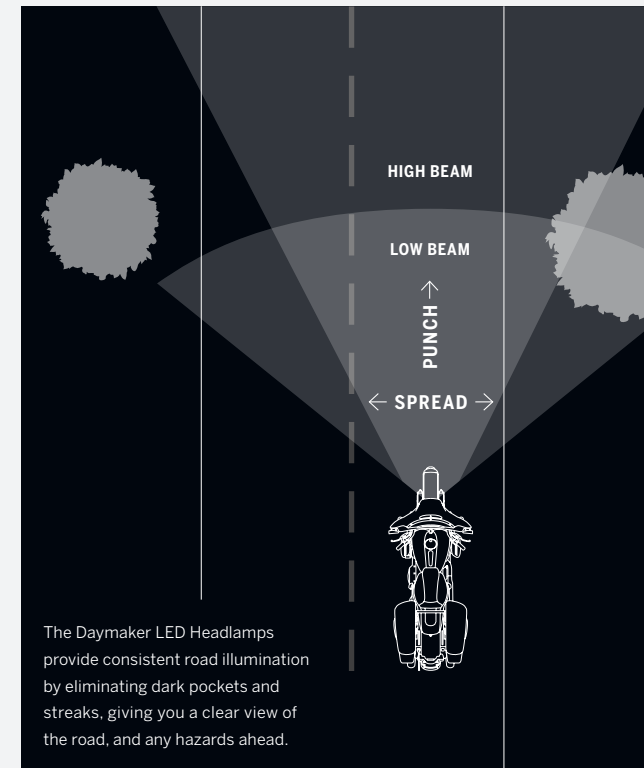

The Daymaker LED Headlamps provide consistent road illumination by eliminating dark pockets and streaks, giving you a clear view of the road, and any hazards ahead.

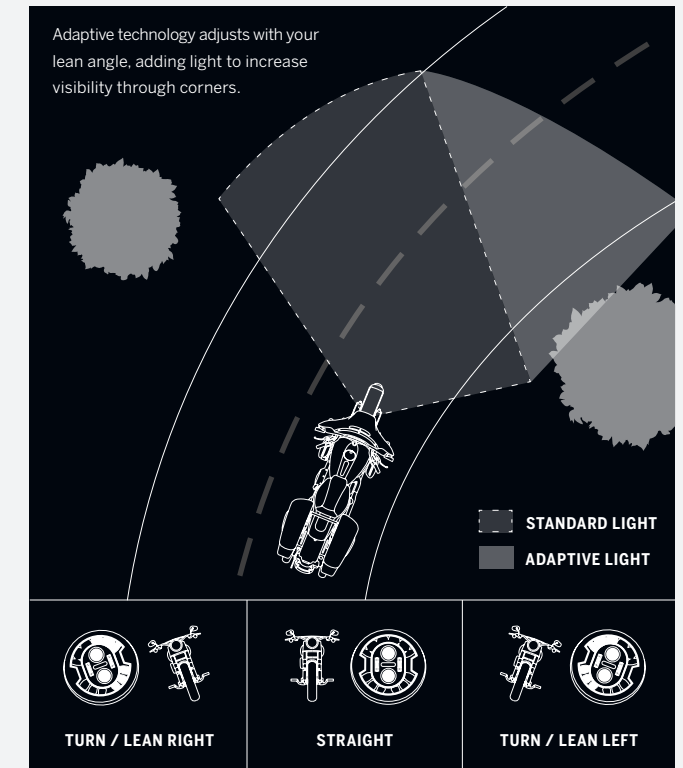

TURN / LEAN RIGHT

STRAIGHT

TURN / LEAN LEFT

LUMENS VS LUX

Lumen is a unit of light, while Lux is a unit of light measurement where the area is also taken into account. The number of Lumens is not the only factor when choosing a headlamp, but also the usable light, or Lux. The Daymaker LED Headlamps have been perfected to utilize both Lumens and Lux, giving you the best visibility of the road.

600 LIGHTING

Headlamps – LED

A. 7" DAYMAKER® ADAPTIVE LED HEADLAMP

The Daymaker® Adaptive Headlamp combines the best in headlight performance with the ultimate in modern styling. The projector-style LED offers best-in-class punch and spread with a pure white light that feels like riding during the day. Best yet, this headlamp features 12 LED spot lights that activate based on the lean of the bike and deliver curb-to-curb lighting that illuminates areas of the road unlit by traditional LED headlamps. Easy to install and extremely durable, the Daymaker Adaptive Headlamp provides functional perfection and exquisite styling all in one. DOT and ECE compliant for all markets.

Fits '12-'16 FLD, '04-'17 FLS, FLSS, FLSTC, FLSTF, FLSTFB, FLSTFBS and FLSTN, '18-later FLDE, FLSL, FLFB, FLFBS, FLHC, FLHCS and FLSB, and '09-later Touring models (except '14 FLHRSE, Road Glide® and Trike models). '12-'16 FLD, '04-'17 Softail® models equipped with Freight Train Headlamp Nacelle Kit and '09-'13 Touring models require separate purchase of Headlamp Mounting Ring P/N 67700439 and Jumper Harness P/N 69201070. '14-'20 FLHR (except '14 FLHRSE), FLHRC, FLHRXS and FLHXST models require separate purchase of Wiring Harness 69202452.

67700426A	Chrome.	\$902.95
67700427A	Black.	\$902.95

Shown with:

4" DAYMAKER PROJECTOR LED AUXILIARY LAMPS

Auxiliary lamps feature D-shaped lenses that focus the light in a pool to the front and sides of the motorcycle and provide a matching appearance to the LED headlamps. The LED Auxiliary Lamps are DOT and ECE compliant.

Fits models with 4" round auxiliary forward lighting. '04-earlier models with auxiliary lamps equipped with spade connectors require separate purchase of Adapter Harness P/N 68355-05 (Qty 2).

68000172	Chrome.	\$425.95
68000173	Gloss Black.	\$425.95

B. 7" DAYMAKER PROJECTOR LED HEADLAMP

The 7" Daymaker LED headlamp features a single top-mount low-beam projector lens, a large bottom-mount high-beam projector lens and 2 D-shaped fill-light lenses. The LED lamps include a subtle rear-lit Bar & Shield logo that glows when the ignition is in the accessory switch position. The LED lamps are DOT and ECE compliant for all markets.

Fits '12-'16 FLD, '04-'17 FLS, FLSS, FLSTC, FLSTF, FLSTFB, FLSTFBS and FLSTN, '18-later FLDE, FLSL, FLFB, FLFBS, FLHC, FLHCS and FLSB, and '09-later Touring and Trike models (except '14 FLHRSE and Road Glide). '12-'16 FLD, '04-'17 Softail models equipped with Freight Train Headlamp Nacelle Kit and '09-'13 Touring models require separate purchase of Headlamp Mounting Ring P/N 67700439 and Jumper Harness P/N 69201070. '14-'20 FLHR (except '14 FLHRSE), FLHRC, FLHRXS, FLHXST and '20-later FLRT (DOM) models require separate purchase of Wiring Harness P/N 69202452.

67700433A	Chrome.	\$610.95
67700430A	Black.	\$610.95



A. 7" DAYMAKER ADAPTIVE LED HEADLAMP – BLACK



A. 7" DAYMAKER ADAPTIVE LED HEADLAMP – CHROME



B. 7" DAYMAKER PROJECTOR LED HEADLAMP – BLACK



B. 7" DAYMAKER PROJECTOR LED HEADLAMP – CHROME



C. 5-3/4" DAYMAKER PROJECTOR LED HEADLAMP



C. 5-3/4" DAYMAKER PROJECTOR LED HEADLAMP – CHROME



C. 5-3/4" DAYMAKER PROJECTOR LED HEADLAMP – BLACK



C. 5-3/4" DAYMAKER PROJECTOR LED HEADLAMP – CHROME



C. 5-3/4" DAYMAKER PROJECTOR LED HEADLAMP – BLACK



D. ROAD GLIDE DAYMAKER PROJECTOR LED HEADLAMP – CHROME



D. ROAD GLIDE DAYMAKER PROJECTOR LED HEADLAMP – CONTRAST CHROME & BLACK

Model Family Fitment:

- V-ROD
- SPORTSTER
- DYNA
- SOFTAIL
- TOURING

Notice: The prices appearing in this catalog are the manufacturer's suggested retail prices. Actual retail prices may vary.

LIGHTING 601

Headlamps – LED

C. 5-3/4" DAYMAKER® PROJECTOR LED HEADLAMP

Lamps feature 2 D-shaped optical lenses, single low-beam lens and three high-beam lenses. The low-beam pattern remains on at all times and the switched high beam adds additional punch down the middle of the road. The LED lamps are DOT and ECE compliant.

Fits '06-'11 VRSCD and VRSCDX, '15-'20 XG, '04-'22 XL, '09-'13 XR, '91-'17 Dyna® (except FLD and '91-'05 FXDWG), '84-'99 FLSTS and FXSTS, '08-'11 FLSTSB, '05-'06 FLSTSC, '10-'12 FLSTSE, '00-'17 FXCW, FXCWC, FXS, FXSB, FXSBSE, FXST, FXSTB, FXSTC and FXSTD models. Some models require Vibration Damper P/N 67700059 or Housing Kit P/N 67700093B.

67700144A	Chrome.	\$447.95
67700145A	Black.	\$447.95

Also available:

HEADLAMP VIBRATION DAMPER

Required for mounting the LED headlight in certain models. This damper adds rigidity to the headlamp housing.

67700059		\$9.95
-----------------	--	---------------

Required on '00-'03 FLSTS, '05-'07 FLSTSC, '07-'10 FXSTC, '00-'07 FXSTD and '00-'06 FXSTS models equipped with LED Headlamp.

Also available:

5-3/4" LED HEADLAMP HOUSING KIT

Required for installation of 5-3/4" LED Headlamp on specified models.

67700093B		\$84.95
------------------	--	----------------

Required on '10-'22 XL1200X, '18-'22 XL1200XS and '06-'17 Dyna models (except FXDL, FXDLS and FXDWG) equipped with 5-3/4" LED headlamps. FXDF models require separate purchase of Mounting Block P/N 67741-06.

D. ROAD GLIDE® DAYMAKER PROJECTOR LED HEADLAMP

Road Glide® lamps feature dual headlamp housings mounted to a common back plate for easy installation. Each lamp features a single low-beam projector lens, 3 high-beam projector lenses and 2 D-shaped fill-light lenses. The low-beam pattern remains illuminated at all times and the switched high-beam adds additional light down the center of the lane. The LED lamps are DOT and ECE compliant.

Fits '04-'13 Road Glide models.

67700109	Chrome.	\$809.95
67700112	Contrast Chrome & Black.	\$833.95

Model Family Fitment:

- V-ROD
- SPORTSTER
- DYNA
- SOFTAIL
- TOURING

Notice: The prices appearing in this catalog are the manufacturer's suggested retail prices. Actual retail prices may vary.

LIGHTING

602 LIGHTING

Headlamps – LED

A. DAYMAKER® SIGNATURE REFLECTOR LED HEADLAMP

Surrounded by a glowing halo of light, these Daymaker® Signature Reflector LED Lamps offer superior nighttime performance while making a bold visual statement. These brilliant LED lamps produce a bright-white beam that lights up the surroundings and draws the attention of oncoming traffic. The natural daylight lamp color is easy on your eyes and is tuned to enhance and amplify the reflective character of highway signs and lane markers. The efficient LED elements are hidden behind the lamp's stylish center crossbar, and project their brilliant light onto the optically tuned reflector bowls for a focused beam of light. The always-on low-beam produces a wide pool of general lighting, and the high beam adds focused light to add punch down the middle of the lane. The long-life solid-state LED lamps are housed in weather-sealed shock and vibration-resistant lamp assemblies. Installation is simple, and the plug-in lamps require no splicing. Meets DOT and ECE standards.



A. 7" DAYMAKER SIGNATURE REFLECTOR LED HEADLAMP – BLACK (SHOWN WITH 4" DAYMAKER SIGNATURE REFLECTOR LED AUXILIARY LAMPS)



A. 7" DAYMAKER SIGNATURE REFLECTOR LED HEADLAMP – CHROME (SHOWN WITH 4" DAYMAKER SIGNATURE REFLECTOR LED AUXILIARY LAMPS)



A. 7" DAYMAKER SIGNATURE REFLECTOR LED HEADLAMP – CHROME



A. 7" DAYMAKER SIGNATURE REFLECTOR LED HEADLAMP – BLACK



A. 5-3/4" DAYMAKER SIGNATURE REFLECTOR LED HEADLAMP – CHROME



A. 5-3/4" DAYMAKER SIGNATURE REFLECTOR LED HEADLAMP – BLACK

Fits '12-'16 FLD, '91-later Softail® equipped with 7" round headlamp, '94-later Touring (except Road Glide®), and '09-later Trike models. '12-'16 FLD, '94-'13 Touring, '09-'13 Trike, and '94-'17 Softail® models equipped with Freight Train Headlamp Nacelle Kit require separate purchase of Headlamp Mounting Ring Kit P/N 67700439 and jumper PN 69201070. '14-'20 FLHR (except '14 FLHRSE), FLHRC, FLHRXS and '20-Later FLRT (DOM) models require separate purchase of Wiring Harness P/N 69202452. Stock on '18-later Softail.

67700353A	7" Chrome.	\$532.95
67700354A	7" Black.	\$532.95

Fits '15-'20 XG500, XG750, '17-'20 XG750A, '11-'20 XL1200C, '10-'22 XL1200X, '18-'22 XL1200XS, '06-'17 FXDB, '16-'17 FXDLS, and '10-'17 FXDWG and '18-later FXBB and FXLR, '20-later FXLRS, FXLRST and '21-later FXBBS models. All models (except XG500, XG750, and XG750A) require separate purchase of Headlamp Bucket Kit P/N 67700455. XL1200C requires separate purchase of Mounting Block P/N 67746-11. Stock on '18-later Softail.

67700356A	5-3/4" Black.	\$425.95
------------------	---------------	-----------------

4" DAYMAKER SIGNATURE REFLECTOR LED AUXILIARY LAMPS

These auxiliary lamps feature reflector bowls that are shaped to add an enhanced pool of light in front of and to the sides of the motorcycle. The LED lamps produce a bright white beam of light, and the modern smooth lens and center-bar reflector design complements the matching Daymaker Signature LED headlamp for a unified look. Meets DOT and ECE standards.

Fits models with 4" round auxiliary forward lighting. '04-earlier models with auxiliary lamps equipped with spade connectors require separate purchase of Adapter Harness P/N 68355-05 (Qty 2).

68000252	Chrome – Pair.	\$382.95
68000253	Black – Pair.	\$382.95

Also available:

7" HEADLAMP MOUNTING RING KIT

Required for installation of accessory 7" LED Headlamps on specific models.

67700439	\$38.95
-----------------	----------------

Fits '12-'16 FLD, '94-'13 Touring (except Road Glide) and '09-'13 Trike models. Also fits '94-'17 Softail models equipped with Freight Train Headlamp Nacelle Kit.

Also available:

5-3/4" LED HEADLAMP HOUSING KIT

Required for installation of 5-3/4" Daymaker Signature LED Headlamp P/N 67700355 or 67700356 on specific models. Kit includes headlamp bucket, mounting blocks and necessary hardware.

67700455	\$151.95
-----------------	-----------------

Fits '10-'20 XL1200C, '10-'22 XL1200X, '18-'22 XL1200XS, '06-'17 FXDB, '16-'17 FXDLS, '10-'17 FXDWG and '13-'17 FXSB models.

Model Family Fitment:

■ V-ROD	■ SPORTSTER	■ DYNA
■ SOFTAIL	■ TOURING	

Notice: The prices appearing in this catalog are the manufacturer's suggested retail prices. Actual retail prices may vary.

LIGHTING 603

Headlamps – LED

B. DAYMAKER® REFLECTOR LED FOG LAMPS

Compact 2.5" bullet-shaped reflector-optics fog lamps produce a bright white pool of light near the vehicle and fill in the dark area between the bike and the low-beam pattern. The fog lamps project a smooth light pattern spread without distracting hot spots and the natural daylight lamp color enhances and amplifies the reflective character of lane markers. Unlike some traditional fog lamps, the low-draw LED lamps do not burden the bike's electrical system. The long-life solid-state LED lamps are sealed in shock and vibration-resistant housings that mount to the engine guard or the Road Glide® fairing for a clean appearance. Fog lamps are DOT and ECE compliant.

Fits Dyna®, Softail®, Touring and Trike (except FLRT) models equipped with 1.25" diameter Engine Guards. Also fits '15-later Road Glide® models with separate purchase of fairing mount Road Glide LED Fog Lamp Mount Kit P/N P/N 68000183 or 68000184. Does not fit models with Mustache Engine Guards. Installation requires separate purchase of model-specific Clamp Kit and Wiring Harness Kit.

68000090	Chrome Housing.	\$432.95
68000092	Gloss Black Housing.	\$432.95

Also available:

LED FOG LAMP WIRING HARNESS

Required for installation of LED Fog Lamp P/N 68000090 or 68000092 on specific models.

69200863	\$33.95
-----------------	----------------

Fits Dyna® and '84-'17 Softail® models. Kit includes universal handlebar-mounted switch.

69201108	\$33.95
-----------------	----------------

Fits '97-later Road King® (except FLHRS). Kit uses Original Equipment nacelle switch to power the fog lamps for Road King®, FHLRXS models require separate purchase of P/Ns 15346-98A, 71522-08 and 74408-08A.

69201109	\$33.95
-----------------	----------------

Fits '14-later Electra Glide®, Road Glide, Street Glide® and Tri Glide® models. Street Glide and Road Glide Custom models require separate purchase of Switch Pack P/N 69200172.

Not required for fairing mount Road Glide LED Fog Lamp Mount Kits, P/N 68000183 and 68000184.

69200864	\$38.95
-----------------	----------------

Fits '97-'13 Electra Glide, Road Glide, Street Glide and Trike models. Models without an Original Equipment fog lamp switch require separate purchase of Switch Kit P/N 71505-96.

C. LED FOG LAMP ENGINE GUARD CLAMP KIT

Required for installation of LED Fog Lamp P/N 68000090 or 68000092 on specific models. Kit includes left and right clamp and all required mounting hardware. Lamps and wiring harnesses sold separately.

Fits Touring and Trike models equipped with 1.25" Engine Guards and fairing lowers.

68000170	Chrome.	\$59.95
68000142	Gloss Black.	\$64.95

Fits Dyna, Softail, Touring, and Trike models equipped with 1.25" engine guards. Does not fit models with Mustache Engine Guards. Does not fit models equipped with Original Equipment or accessory fairing lowers.

68000171	Chrome.	\$59.95
68000141	Gloss Black.	\$59.95

D. ROAD GLIDE® LED FOG LAMP MOUNT KIT

This elegant Mount Kit replaces the Original Equipment turn signal mount, and positions the Daymaker® Reflector LED Fog Lamps and turn signals close to the fairing for a custom look. The resulting installation provides a supplemental pool of light in front of the motorcycle, and a clean, uncluttered look to your bike's profile. Mount can be used with Original Equipment or accessory Bullet Turn Signals. Available in chrome or gloss black finish, the kit includes left and right mounts and all required hardware. Requires separate purchase of Daymaker Reflector LED Fog Lamps.

Fits '15-later Road Glide® and '23-later FLTRT models with Original Equipment or accessory bullet turn signals. Requires separate purchase of Daymaker® Reflector LED Fog Lamps. May require purchase of OEM switch pack, see dealer for details.

68000183	Chrome.	\$107.95
68000184	Gloss Black.	\$107.95

Notice: The prices appearing in this catalog are the manufacturer's suggested retail prices. Actual retail prices may vary.



B. DAYMAKER REFLECTOR LED FOG LAMPS



B. DAYMAKER REFLECTOR LED FOG LAMPS – CHROME HOUSING



B. DAYMAKER REFLECTOR LED FOG LAMPS – GLOSS BLACK HOUSING



B. DAYMAKER REFLECTOR LED FOG LAMPS – CHROME & GLOSS BLACK



C. LED FOG LAMP ENGINE GUARD CLAMP KITS – CHROME & GLOSS BLACK



D. ROAD GLIDE LED FOG LAMP MOUNT KIT – CHROME



D. ROAD GLIDE LED FOG LAMP MOUNT KIT – GLOSS BLACK

LIGHTING

604 LIGHTING

Headlamps – Auxiliary

A. DELUXE AUXILIARY LIGHTING KIT – FL SOFTAIL® MODELS

Shaped by the wind. These billet-look mounting brackets hug the contour of the smooth chrome Triple Tree Cover (included). Separate purchase of the sealed lamp is required to allow the flexibility to choose from four different styles. Bulbs sold separately.

68669-05A Domestic. **\$473.95**
Fits '00-'17 FLS, FLSS, FLSTF, FLSTFB and FLSTFBS and '06 FLST models. Compatible with Nostalgic Windshield Kit P/N 57140-05, 57181-05 and 57141-05 only. Does not fit with Accessory Nacelle Kits.

B. AUXILIARY LAMP BULB KITS

Available in 3 lens styles, these sealed beam bulbs are a direct replacement for Original Equipment or accessory Auxiliary Lighting Kits.

Fits all models with Original Equipment or accessory Auxiliary Lighting Kits (except '18-later Softail®, '14-later Street Glide®, Electra Glide®, Ultra Limited and Trike models). Sold in pairs.

1. Clear Lens with Halogen Bulb
68208-98A **\$79.95**

2. Clear Lens and Vertical Reflector Optics
68348-05 **\$79.95**

C. INDEPENDENT CONTROL AUXILIARY LAMP WIRE HARNESS KIT

Maximize your nighttime view down a lonely stretch of back road. This simple-to-install wiring harness permits independent control of your bike's auxiliary lamps and allows the lamps to be switched on when the headlamp is in either the low or high beam setting.

69200441 **\$38.95**
Fits '98-'13 Electra Glide, Street Glide and Trike models equipped with auxiliary lamps.

69200442 **\$33.95**
Fits '96-'17 FL Softail® and '97-'13 Road King® models equipped with auxiliary lamps.



A. DELUXE AUXILIARY LIGHTING KIT – FL SOFTAIL MODELS (SHOWN WITH AUXILIARY LAMP BULB KIT)



B. AUXILIARY LAMP BULB KITS



C. INDEPENDENT CONTROL AUXILIARY LAMP WIRE HARNESS KIT (TOURING SHOWN)

Model Family Fitment:

■ V-ROD	■ SPORTSTER	■ DYNA
■ SOFTAIL	■ TOURING	



D. CUSTOM AUXILIARY LIGHTING KIT – CHROME (67800367A SHOWN)



D. CUSTOM AUXILIARY LIGHTING KIT – CHROME



D. CUSTOM AUXILIARY LIGHTING KIT – GLOSS BLACK



E. DAYMAKER LED FORWARD AUXILIARY LIGHTS



F. AUXILIARY LIGHT INSTALLATION KIT

LIGHTING 605

Headlamps – Auxiliary

D. CUSTOM AUXILIARY LIGHTING KIT

Shaped by the wind, this Auxiliary Lighting Kit follows the contours of the triple tree and headlamp shell for a custom look. The elegant cantilever brackets serve as stylized mounting points for the passing lamp and turn signal housings and eliminate the cross brace and flat side supports of traditional auxiliary lamps.

Fits '14-later FLHT, FLHX, FLHXS and FLHXST models. Kit includes passing lamp housings, retaining rings, mounting brackets, bullet turn signals, auxiliary lamp switch and hardware. Auxiliary Lamp Bulbs sold separately.

67800367A Chrome. **\$462.95**
67800366A Gloss Black. **\$462.95**

68000042 Gloss Black. **\$432.95**
Fits '06-'13 FLHX and '10-'11 FLHXXX models. Kit includes passing lamp housings, retaining rings, mounting brackets, auxiliary lamp switch and hardware. Auxiliary Lamp Bulbs and Bullet Turn Signal Kits sold separately.

Also available: CUSTOM AUXILIARY LAMP BRACKET TURN SIGNAL KIT

Add your choice of Bullet Style Turn Signals to the Custom Passing Lamp Bracket. Select from amber, clear or smoked lens turn signal kits to complement your custom direction. Kit includes left and right bullet turn signal housing, two lenses and two front bulbs.

Fits '94-'13 FLHR and '97-'13 FLHT and FLHX models equipped with Custom Auxiliary Lighting Bracket Kits.

69228-04 Chrome Smoked Lens, Amber Bulb. **\$79.95**
67800166 Black Smoked Lens, Amber Bulb. **\$79.95**

Also available: CUSTOM AUXILIARY LAMP BRACKET HARDWARE KIT

Add Custom Passing Lamp Brackets to your Road King model.

69235-04 **\$11.95**

Required to install the Custom Auxiliary Lighting Bracket Kit P/N 69227-04A on '94-'13 Road King® models equipped with a H-D™ Detachables™.

69234-04 **\$20.95**
Required to install the Custom Auxiliary Lighting Bracket Kit P/N 69227-04A on FLHRS models not presently equipped with a windshield, but wish to install a windshield at the same time or in the future.

E. DAYMAKER® LED FORWARD AUXILIARY LIGHTS

These rugged auxiliary LED lights offer three-way function that will serve the adventure touring rider in any situation. Installed as a pair, each light has a three beam, four-lens design within durable aluminum housing. In daylight these lights also make the motorcycle more conspicuous to other motorists. The factory-integrated design makes these lights easy to install and a perfect fit and look on the bike. Fog lights produce a widepool of light directly in front of the motorcycle to light the edge of the road in low-visibility conditions. Driving lights punch light further down the road to augment headlight performance. Off-Road beams deliver 275-meter forward visibility and 50-meter side visibility to light up the trail (not street legal). Powder coated lightweight Aluminum housing. High-impact hard-coated and anti-fog coated outer lens. Sold as a pair. Installation requires separate purchase of Auxiliary Light Installation Kit.

68000340 **\$532.95**
Fits '21-later RA1250 and RA1250S models equipped with Brush Guard and '14-later Touring models. RA1250 requires separate purchase of Brush Guard P/N 49000192. Separate purchase of model-specific installation kit is required.

F. AUXILIARY LIGHT INSTALLATION KIT

Installation kit includes a wiring harness, mounting brackets, and switch pack for installing Daymaker LED Forward Auxiliary Lights.

Fits '21-later RA1250 and RA1250S models.

68000343 **\$170.95**

Fits '14-later Touring models (except Road Glide® models).

68000341 **\$170.95**

Fits '14-later Road Glide models. '14-'16 models require Connector Adapter P/N 69201900.

68000342 **\$170.95**

Notice: The prices appearing in this catalog are the manufacturer's suggested retail prices. Actual retail prices may vary.

LIGHTING

606 LIGHTING

Headlamp Trim

A. FRENCHED TRIM RING COLLECTION

This chrome-plated Headlamp Trim Ring extends forward, giving the headlamp assembly a frenched look reminiscent of classic hot rod car designs by recessing the headlamp and adding the appearance of depth. Functions as a direct replacement for the Original Equipment trim ring, except when used with P/N 69627-99, where it easily installs over the Original Equipment trim ring. (Does not fit with Accessory Headlamp Visor or Passing Lamp Visor.)

1. 69627-99 Headlamp. **\$47.95**
Fits '12-'16 FLD, '94-later Road King®, '83-'13 Touring (except Tour Glide™ and Road Glide®) and '08-'13 Trike models. Also Fits '86-'17 FL Softail® models with Freight Train Headlight Nacelle. (Does not fit with Fairing Bra P/N 57800-00.)

2. 69622-99B Passing Lamp. **\$64.95**
Fits '62-later models equipped with Original Equipment or accessory Auxiliary Lamp Kits. Sold in pairs.

3. 69740-01 Turn Signal – Flat Lens. **\$50.95**
Fits flat lens turn signals on rear of '06 FLST, '94-'17 FLSTC, '94-'97 FLSTN and on the front and rear of '14-later FLHR, FLHRC and '88-'13 Touring (except FLHRS, FLHX and '04-'13 FLTR) models. Also fits FL Softail models with front Turn Signal Relocation Kit P/N 68413-99 or 68412-99.

67700215 Headlamp. **\$48.95**
Fits '94-later Road King, '14-later Electra Glide®, Street Glide®, Ultra Limited and Tri Glide® models.

69626-99 Headlamp. **\$47.95**
Fits '94-'17 FLS, FLSS, FLSTF, FLSTFB, FLSTFBS and FLSTN and '15-later FLRT models.

69623-99A Headlamp. **\$41.95**
Fits '05 VRSCB, '04-'22 XL883, XL883L, XL883N, XL883R, XL1200L, XL1200N, XL1200R, XL1200T, XL1200X and XL1200XS, '16-'20 XL1200CX, '94-'17 Dyna® (except FXDF and FLD equipped with 7" headlamp), '94-'15 FXLR, FXST and FXSTB, '08-'17 FLSTSB and FXS, '16-'17 FXSE and '94-'99 FXSTC models.

69624-99A Headlamp. **\$41.95**
Fits '96-'22 XL883C, XL1200C and XL1200V, '16-'20 XL1200CX, '99 FXR, '16-'17 FXDLS, '97-'03 FLSTS, '05-'07 FLSTSC, '16-'17 FXSE, '07-'10 FXSTC, '00-'07 FXSTD, '93-'06 FXSTS and '95-'97 FXSTSB models.

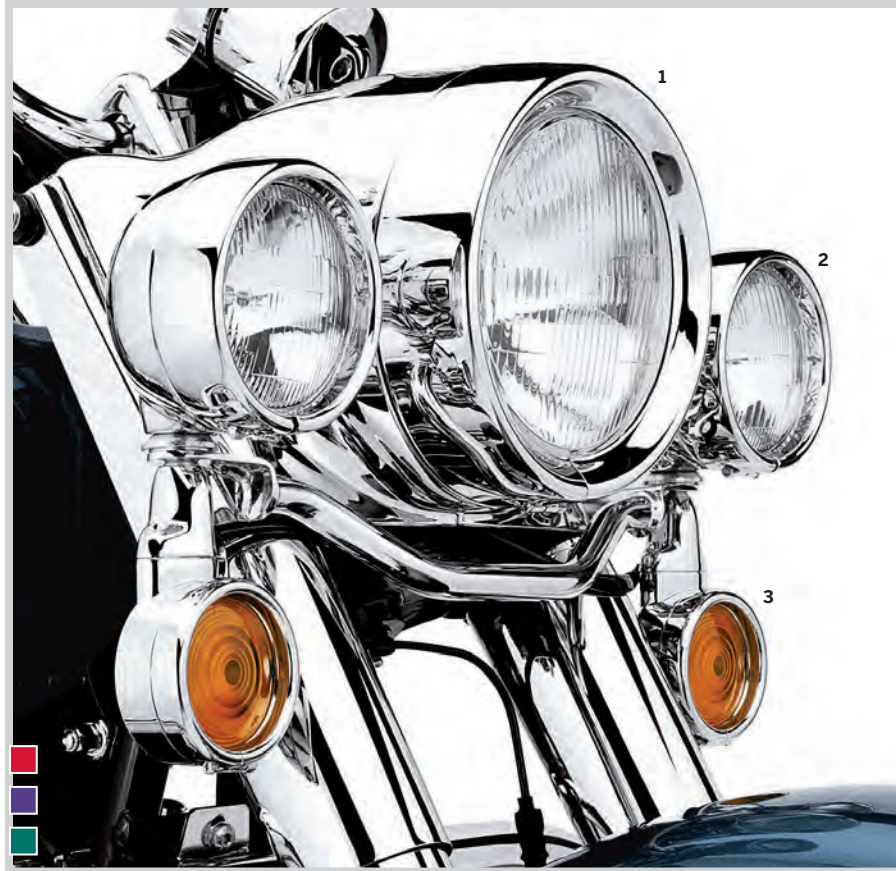

**A. FRENCHED TRIM RING COLLECTION
(HEADLAMP, PASSING LAMP AND TURN SIGNAL TRIM RINGS) – ROAD KING**



**B. VISOR STYLE TRIM RING COLLECTION
(HEADLAMP, PASSING LAMP AND TURN SIGNAL TRIM RINGS) – ROAD KING**

LIGHTING 607

Headlamp Trim

B. VISOR STYLE TRIM RING COLLECTION

These chrome-plated Visor Style Trim Rings recess the headlamp into the housing and add a traditional eyebrow design to the headlamp shell. The trim ring stretches the profile of the bike for a long, lean appearance. Add matching Visor Style Passing Lamp and Turn Signal Trim Rings for a true custom look.

1. 69733-05 Headlamp. **\$47.95**
Fits '12-'16 FLD, '94-later Road King®, '83-'13 Touring (except Tour Glide™ and Road Glide®) and '08-'13 Trike models. Also fits '86-'17 FL Softail® models with Freight Train Headlight Nacelle. (Does not fit with Fairing Bra P/N 57800-00.)

2. 69732-05 Passing Lamp. **\$64.95**
Fits '62-later models equipped with Original Equipment or accessory Auxiliary Lamp Kits. Sold in pairs.

3. 69749-05 Turn Signal – Flat Lens. **\$50.95**
Fits flat lens turn signals on rear of '06 FLST, '94-'17 FLSTC, '94-'97 FLSTN and on the front and rear of '14-later FLHR, FLHRC and '88-'13 Touring (except FLHRS, FLHX and '04-'13 FLTR) models. Also fits FL Softail models with front Turn Signal Relocation Kit P/N 68413-99 or 68412-99.

67700216 Headlamp. **\$48.95**
Fits '94-later Road King, '14-later Electra Glide®, Street Glide®, Ultra Limited and Tri Glide® models.

69734-05 Headlamp. **\$47.95**
Fits '94-'17 FLS, FLSS, FLSTF, FLSTFB, FLSTFBS and FLSTN and '15-later FLRT models.

69735-05 Headlamp. **\$41.95**
Fits '05 VRSCB, '04-'22 XL883, XL883L, XL883N, XL883R, XL1200L, XL1200N, XL1200R, XL1200T, XL1200X, and XL1200XS, '12-'20 XL1200C, '16-'20 XL1200CX, '94-'17 Dyna® (except FXDF and FLD equipped with 7" headlamp), '94-'15 FXLR, FXST and FXSTB, '08-'17 FLSTSB and FXS, '16-'17 FXSE and '94-'99 FXSTC models.

69738-05 Headlamp. **\$41.95**
Fits '96-'22 XL883C, XL1200C and XL1200V, '16-'20 XL1200CX, '18-'22 XL1200XS, '99 FXR, '97-'03 FLSTS, '05-'07 FLSTSC, '07-'10 FXSTC, '00-'07 FXSTD, '93-'06 FXSTS and '95-'97 FXSTSB models.



A. FRENCHED TRIM RING – ELECTRA GLIDE



A. FRENCHED TRIM RING – SOFTAIL STANDARD



B. VISOR STYLE TRIM RING – ELECTRA GLIDE



B. VISOR STYLE TRIM RING – SOFTAIL DELUXE



A. FRENCHED TRIM RING – DYNA LOW RIDER



A. FRENCHED TRIM RING – XL883 LOW



B. VISOR STYLE TRIM RING – XL/DYNA



B. VISOR STYLE TRIM RING – XL CUSTOM

Model Family Fitment:

- V-ROD
- SPORTSTER
- DYNA
- SOFTAIL
- TOURING

Notice: The prices appearing in this catalog are the manufacturer's suggested retail prices. Actual retail prices may vary.

Notice: The prices appearing in this catalog are the manufacturer's suggested retail prices. Actual retail prices may vary.

608 LIGHTING

Headlamp Trim Rings

A. HEADLAMP TRIM RING – GLOSS BLACK

Finish the Dark Custom look by replacing the Original Equipment chrome headlamp trim ring with sinister black. Easy to install, the ring's rich black surface matches the stock headlamp shell finish for a unified look.

46555-03B 7" Headlamp. **\$47.95**
Fits '94-later Touring (except Road Glide®) and FLHTCUTG models.

61400573 7" Headlamp. **\$47.95**
Fits '18-later FLDE, FLHC, FLHCS, FLSB and FLSL models.

67700487 7" Headlamp. **\$28.95**
Fits '93-later Softail® models and '15-later FLRT models with 7" Headlamp. Does not fit Softail models equipped with Freight Train Nacelle Headlamp Kit.

67700115 7" Headlamp. **\$48.95**
Fits '08-'17 FLS, FLSS, FLSTF, FLSTFB, FLSTFBS and FLSTN and '15-later FLRT models.

61400574 5-3/4" Headlamp. **\$42.95**
Fits '18-later FXBB, FXLR, FXST and FXBBS models.

67700116 5-3/4" Headlamp. **\$43.95**
Fits '05 VRSCB, '04-'22 XL883, XL883L, XL883N, XL883R, XL1200L, XL1200N, XL1200R, XL1200T, XL1200X, and XL1200XS, '12-'20 XL1200C, '16-'20 XL1200CX, '94-'17 Dyna® (except FXDF and FLD equipped with 7" headlamp), '94-'15 FXLR, FXST and FXSTB, '08-'17 FLSTSB and FXS, '16-'17 FXSE and '94-'99 FXSTC models.

67700117 4" Passing Lamp. **\$54.95**
Fits '62-later models equipped with Original Equipment or accessory Auxiliary Lamp Kits. Sold in pairs.

B. CONTOURED HEADLAMP TRIM RING

Add an integrated look to your headlamp. The Contoured Headlamp Trim Ring, introduced on the Screamin' Eagle® Road King model, is designed to visually reduce the space between the headlamp bulb and the headlamp housing for a sleek, custom style. The bright chrome finish matches the headlamp housing for a factory original look.

69604-03A **\$63.95**
Fits '83-later Touring (except Tour Glide™ and Road Glide®). Also fits '86-'17 FL Softail® models with Freight Train Headlight Nacelle. Does not fit Trike models.



A. HEADLAMP TRIM RING – GLOSS BLACK (ROAD KING SHOWN)



A. HEADLAMP TRIM RING – GLOSS BLACK ('19 SOFTAIL SLIM SHOWN)



A. HEADLAMP TRIM RING – GLOSS BLACK (FAT BOY LO SHOWN)



A. HEADLAMP TRIM RING – GLOSS BLACK ('19 STREET BOB SHOWN)



A. HEADLAMP TRIM RING – GLOSS BLACK (IRON 883 SHOWN)



B. CONTOURED HEADLAMP TRIM RING



C. FRENCHED TRIM RING COLLECTION – GLOSS BLACK (ELECTRA GLIDE SHOWN)



C. FRENCHED TRIM RING COLLECTION – GLOSS BLACK (ROAD KING SHOWN)



D. VISOR STYLE TRIM RING COLLECTION – GLOSS BLACK (ELECTRA GLIDE SHOWN)



D. VISOR STYLE TRIM RING COLLECTION – GLOSS BLACK (ROAD KING SHOWN)

LIGHTING 609

Headlamp Trim Rings

C. FRENCHED TRIM RING COLLECTION – GLOSS BLACK

This easy-to-install Headlamp Trim Ring extends forward, giving the headlamp assembly a frenched look reminiscent of classic hot rod car designs by recessing the headlamp and adding the appearance of depth. Does not fit with accessory Headlamp Visors or Passing Lamp Visors.

61400294 7" Headlamp – Gloss Black. **\$58.95**
Fits '94-later Road King®, '14-later Electra Glide®, Street Glide®, Ultra Limited and Tri Glide® models.

61400295 7" Headlamp – Gloss Black. **\$58.95**
Fits '12-'16 FLD, '83-'13 Touring (except Tour Glide™ and Road Glide®), '94-later Road King and '08-'13 Trike models. Also fits '86-'17 FL Softail® models with Freight Train Headlight Nacelle. Does not fit with Fairing Bra P/N 57800-00.

D. VISOR STYLE TRIM RING COLLECTION – GLOSS BLACK

These easy-to-install Visor Style Trim Rings recess the headlamp into the housing and add a traditional eyebrow design to the headlamp shell. The trim ring stretches the profile of the bike for a long, lean appearance.

61400292 7" Headlamp – Gloss Black. **\$58.95**
Fits '94-later Road King, '14-later Electra Glide, Street Glide, Ultra Limited and Tri Glide models.

61400293 7" Headlamp – Gloss Black. **\$58.95**
Fits '12-'16 FLD, '83-'13 Touring (except Tour Glide™ and Road Glide®), '94-later Road King and '08-'13 Trike models. Also fits '86-'17 FL Softail models with Freight Train Headlight Nacelle. Does not fit with Fairing Bra P/N 57800-00.

Model Family Fitment:

- V-ROD
- SPORTSTER
- DYNA
- SOFTAIL
- TOURING

Notice: The prices appearing in this catalog are the manufacturer's suggested retail prices. Actual retail prices may vary.

Notice: The prices appearing in this catalog are the manufacturer's suggested retail prices. Actual retail prices may vary.

610 LIGHTING

Headlamp Trim Rings

A. LAMP VISORS

This complete collection of Lamp Visors dresses your bike for a true custom look.

Headlamp

Fits 7" Headlamp (except '18-later Softail® and '14-later FLHT, FLTHCU, FLHTCUL, FLHTK, FLHTKL, FLHTKSE, FLHX, FLHXS, FLHXST, FLHXSE, FLTRKSE, FLTRU, FLTRX, FLTRXS, FLTRXST, FLTRXSE, FLHTCUTG models). (Does not fit with accessory Headlamp Trim Rings.) Road King® models require separate purchase of Headlamp Mounting Kit P/N 67761-96.

69793-07	Skull.	\$30.95
67752-77T	Classic Chrome.	\$20.95
67791-91T	Eagle Wing.	\$39.95

Headlamp

Fits 5-3/4" Headlamp. (Does not fit Heritage Springer™, XL883C, XL1200C, XL1200NS, XL1200V, '18-later Fits 5-3/4" Headlamp. (Does not fit Heritage Springer, XL883C, XL1200C, XL1200NS, XL1200T, XL1200V, '18-later Softail models or models with Accessory Headlamp Trim Rings.)

67750-88T	Classic Chrome.	\$21.95
67751-91T	Eagle Wing.	\$34.95

Passing Lamp

Fits all Passing Lamps. ('87-later models require Passing Lamp Trim Rings P/N 68775-93TA.) (Does not fit models with Passing Lamp Trim Rings P/N 69622-99B or 69732-05.) Sold in pairs.

69795-07	Skull.	\$33.95
67783-78T	Classic Chrome.	\$26.95
67796-91T	Eagle Wing.	\$37.95

Flat Lens Turn Signal

Fits front turn signals on '88-'17 FLSTC, '94-later FLHR, '07-later FLHRC, '86-'09 FLHT, '86-'13 FLHTC, '89-'13 FLHTCU and '10-'13 FLHTK models. Sold in pairs.

67734-88T	Classic Chrome.	\$24.95
67735-91T	Eagle Wing.	\$36.95

Flat Lens Turn Signal

Fits rear turn signals on '86-'92 FXRT, '86-'90 FLST, '88-'17 FLSTC, '94-later FLHR, '07-later FLHRC, '86-'09 FLHT, '86-'13 FLHTC, '89-'13 FLHTCU and '10-'13 FLHTK models. Also fits front and rear turn signals on '88-'91 FLTC, '89-'96 FLTCU and '99-'03 FLTR models. Sold in pairs.

67737-88T	Classic Chrome.	\$24.95
67738-91T	Eagle Wing.	\$36.95

Also available:

ROAD KING® HEADLAMP VISOR MOUNTING KIT

Allows 7" headlamp visors to be mounted on Road King® motorcycle.

67761-96		\$6.95
-----------------	--	---------------

Fits '94-later FLHR, FLHRC and FLHRXS models. Visor and Trim Ring not included.

Also available:

PASSING LAMP TRIM RINGS

68775-93TA		\$30.95
-------------------	--	----------------

Replaces Original Equipment P/N 68725-62. Required for proper installation of H-D® Passing Lamp Visors on '87-later models (except FXSTD).

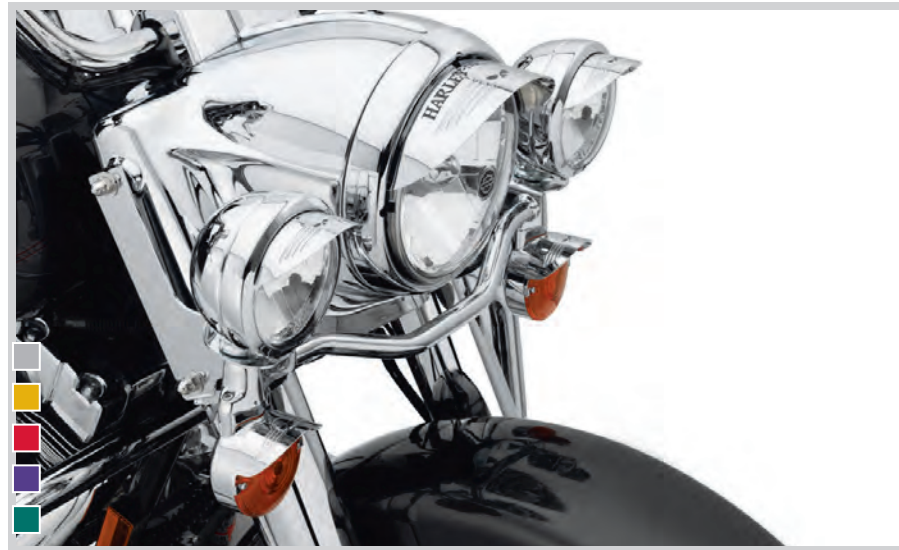

A. SKULL COLLECTION LAMP VISORS



A. CLASSIC CHROME LAMP VISORS



A. EAGLE WING LOGO LAMP VISORS



B. BULLET TURN SIGNAL TRIM RINGS – VISOR STYLE



B. BULLET TURN SIGNAL TRIM RINGS – FRENCHED STYLE



C. BULLET TURN SIGNAL VISOR TRIM RINGS – BLACK



LIGHTING 611

Turn Signal Trim

B. BULLET TURN SIGNAL TRIM RINGS

Trim ring contour matches the turn signal housing and extends out past the lens for a sleek appearance. These easy-to-install chrome-plated trim rings look great alone or in combination with Headlamp Trim Rings. Available in Visor Style for a nostalgic look or in Trim Ring style for contemporary frenched contour. Sold in pairs.

Front or Rear, Amber Lenses

Fits models equipped with bullet style turn signals (except models equipped with stop/tail/turn lights).

69756-05	Amber, Visor Style.	\$37.95
69739-01	Amber, Frenched Style.	\$37.95

Front, Lenses with Amber Bulbs

Fits models equipped with front bullet style turn signals (except models equipped with Original Equipment or Accessory LED turn signals).

69758-05	Smoked, Visor Style.	\$40.95
69752-04	Smoked, Frenched Style.	\$40.95
69760-05	Clear, Visor Style.	\$40.95

Rear, Lenses with Amber Bulbs

Fits models equipped with bullet style turn signals (except models equipped with stop/tail/turn lights).

69759-05	Smoked, Visor Style.	\$40.95
69753-04	Smoked, Frenched Style.	\$40.95
69761-05	Clear, Visor Style.	\$40.95

Rear, Red Lenses

Fits rear of models equipped with bullet style turn signals (except models equipped with stop/tail/turn lights).

69757-05	Red, Visor Style.	\$37.95
69736-02	Red, Frenched Style.	\$37.95

C. BULLET TURN SIGNAL VISOR TRIM RING – BLACK

Visor-shaped trim rings add a traditional look to the contemporary style of the bullet turn signal. These easy-to-install black finish trim rings are available with smoked or red lenses to match your customizing direction. Sold in pairs.

73342-09 Front, Smoked Lens, Amber Bulb. **\$40.95**
Fits '08-'22 XL883N, XL1200N, XL1200NS, XL1200X and XL1200XS, '11-'13 XL1200C, '16-'20 XL1200CX, and '08-later FL Softail® models (except '18-later FLDE). Does not fit FLSTC or models equipped with Original Equipment or accessory LED signal lamps.

73343-09 Rear, Smoked Lens, Amber Bulb. **\$40.95**
Fits '09-'17 FLSTSB models (except models equipped with Original Equipment or accessory LED turn signals).

73344-09 Rear, Red Lens. **\$37.95**
Fits '08-'22 XL883N and XL1200N, '18-'22 XL1200NS and XL1200XS, '11-'22 XL1200C, '16-'20 XL1200CX and '08-'13 XL1200V and XL1200X models (except models equipped with Original Equipment or accessory LED turn signals). Also fits FL Softail models equipped with Auxiliary Turn Signal and Brake Light Kit P/N 69462-06B.

Model Family Fitment:

■ V-ROD	■ SPORTSTER	■ DYNA
■ SOFTAIL	■ TOURING	

Notice: The prices appearing in this catalog are the manufacturer's suggested retail prices. Actual retail prices may vary.

Notice: The prices appearing in this catalog are the manufacturer's suggested retail prices. Actual retail prices may vary.

612 LIGHTING

Turn Signals

A. CUSTOM TOURING FRONT BULLET TURN SIGNAL KIT

Add the lean, stripped-down look of the FLHX models to your Electra Glide® or Road King® motorcycle. Complete kit replaces the Original Equipment passing lamps and flat lens turn signal mounts with streamlined bullet-style turn signals. The chrome-plated brackets serve as stylized mounting points for the turn signals and conceal the wiring for a clean, custom appearance.

69577-06A Chrome with Amber Lens. **\$178.95**
Fits '94-later Road King (except FLHRXS) models.

69492-05 Chrome with Amber Lens. **\$158.95**
Fits '96-'13 FLHT and FLHTC, '05-'13 FLHTCU and FLHTK and '09-'13 FLHTCUTG models. Will not fit vehicles equipped with Non-Vented Fairing Lower.

67800167 Gloss Black with Smoked Lenses. **\$160.95**
Fits '96-'13 FLHT, FLHTC and FLHX, '05-'13 FLHTCU and FLHTK and '09-'13 FLHTCUTG models. Will not fit vehicles equipped with Non-Vented Fairing Lower.

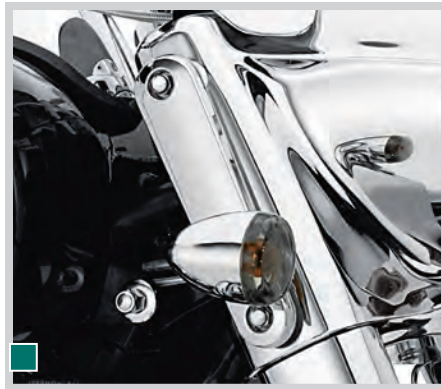

A. CUSTOM TOURING FRONT BULLET TURN SIGNAL KIT – CHROME



B. STREET GLIDE® FRONT BULLET TURN SIGNAL MOUNT KIT – GLOSS BLACK

Complement the lean, stripped-down look of your Street Glide® model. Manufactured from Original Equipment components, these rich gloss black Turn Signal Mounts replace the factory-installed chrome mounts to complete the blacked-out look. The brackets serve as stylized mounting points for the Original Equipment or accessory LED bullet turn signals, and conceal the wiring for a clean, custom appearance. Kit includes left and right mounting bracket.

67800706 **\$107.95**
Fits '14-later FLHT, FLHX, FLHXS and FLHXSE models.



A. CUSTOM TOURING FRONT BULLET TURN SIGNAL KIT – GLOSS BLACK



C. ROAD GLIDE® FRONT BULLET TURN SIGNAL MOUNTS – GLOSS BLACK

Complete the sinister look of your Road Glide® model. Manufactured from Original Equipment components, these rich gloss black Turn Signal Mounts replace the factory-installed chrome mounts, and continue the blacked-out look. The brackets serve as stylized mounting points for the Original Equipment or accessory LED bullet turn signals, and are the perfect complement to Gloss Black Fairing Support P/N 47200278, a gloss black engine guard and gloss black front end components. Kit includes right and left hand mounts.

67800707 **\$89.95**
Fits '15-later Road Glide models.



B. STREET GLIDE FRONT BULLET TURN SIGNAL MOUNT KIT – GLOSS BLACK



C. ROAD GLIDE FRONT BULLET TURN SIGNAL MOUNTS – GLOSS BLACK



D. LED BULLET TURN SIGNAL KIT – TOURING, AMBER LENS



D. LED BULLET TURN SIGNAL KIT – TOURING, SMOKED LENS



D. LED BULLET TURN SIGNAL KIT – AMBER LENS



D. LED BULLET TURN SIGNAL KIT – SMOKED LENS



D. LED BULLET TURN SIGNAL KIT – RED LENS



E. TURN SIGNAL LENS KIT – CLEAR, BULLET LENS



E. TURN SIGNAL LENS KIT – SMOKED, BULLET LENS

LIGHTING 613

Turn Signals

D. LED BULLET TURN SIGNAL KIT

These Turn Signals feature fast-acting, extra-bright LEDs set in compact bullet-shaped die-cast chrome housings. In the front, the lights function as running light and directional indicators. In the rear, the lights function as running light, brake light and directional indicators. The front amber lights are available in your choice of smoked or amber lens and the red rear lights are offered with either smoked or red lens. Installation does not require installation of a "control box" or load equalizer and the turn signals attach directly to existing wiring without cutting or splicing. Featuring a Bar & Shield medallion, these signals are the perfect match for the available LED Tail Lamps. Sold in pairs. Meets DOT requirements.

Fits '14-later Touring and Tri Glide® models with bullet turn signals.

67800477 Chrome – Amber Lens. **\$213.95**

67800478 Chrome – Smoked Lens. **\$213.95**

67800061 Front, Amber Lens. **\$213.95**

Fits '12-'17 Dyna® (except '15-'17 FXDBC), '11-'17 FLS, FLSS, FLSTF, FLSTFB, FLSTFBS and FXS, '08-'11 FLSTSB. Does not fit '11-'12 FLSTSE models.

E. TURN SIGNAL LENS KIT – SMOKED AND CLEAR

Add a unique touch to your bike. These Turn Signal Lens Kits replace the amber lenses for a clean front and rear appearance. Available in clear and smoked versions. Meets DOT requirements.

Fits '00-later models with bullet turn signals (except VRSC™ and models equipped with rear red lens stop/turn/tail signals). Will also fit V-Rod® models equipped with Chrome Turn Signal Kit P/N 69374-05 or 69065-05. Kit includes 4 lenses and 4 amber bulbs.

69303-02 Clear – Bullet Lens. **\$43.95**

69304-02 Smoked – Bullet Lens. **\$43.95**

Fits front lenses on '08-'22 XL883N, XL1200CX, XL1200N, XL1200T and XL1200X, '11-'22 XL1200C and XL1200V, '16-'17 FXDLS, '12-'17 FLS and FLSS, '08-'11 FXCW and FXCWC, '11-'13 FXS and '16-'17 FXSE models. This kit includes 2 lenses and 2 amber bulbs.

69208-09 Smoked – Bullet Lens. **\$28.95**

LIGHTING

Notice: The prices appearing in this catalog are the manufacturer's suggested retail prices. Actual retail prices may vary.

Notice: The prices appearing in this catalog are the manufacturer's suggested retail prices. Actual retail prices may vary.

614 LIGHTING

Turn Signals

FRONT AND REAR SIGNATURE LED SIGNAL INSERTS

LED Turn Signals deliver modern signature style and function that improves rider conspicuity to surrounding traffic. The light pipe outer "signature" ring adds visibility and unique styling, while brilliant center LED elements flash with an eye-catching signal. Easy plug-and-play installation to Original Equipment signal housing takes less than five minutes.

A. FRONT SIGNATURE LED TURN SIGNAL INSERTS – AMBER/WHITE, SMOKED LENS

Signature LED turn signal insert with smoked lens provides a bright white daytime running lamp which turns off when the amber colored turn signal is activated.

67801147 DOT Compliant. **\$124.95**
Fits domestic '16-later CVO™ models equipped with LED Bullet Turn Signals. Does not fit models with plastic bullet turn signals.

67801148 DOT Compliant. **\$124.95**
Fits domestic '14-later Softail® (except '14-'15 FLSTF, FLSTFB, and FXSB), Dyna® (except '14-'17 FXDF, FXDL, FXDWG, FXDBP, and FXDP), Touring, Trike and XL models. Also fits '14-'15 CVO (except FXSBSE) models equipped with bullet turn signals. Does not fit models with plastic bullet turn signals.

B. SIGNATURE LED TURN SIGNAL INSERTS – AMBER/AMBER SMOKED LENS

Signature LED turn signal insert with smoked lens and amber colored turn signal.

67801184 ECE Compliant. **\$124.95**

Front:

Fits international '14-later Softail (except '14-'15 FLSTF, FLSTFB, FXSB), Dyna (except '14-'17 FXDF, FXDL, FXDWG, FXDBP, FXDP), Touring, Trike (Australia only), '14-later Domestic XL, and '14-'15 CVO (except FXSBSE) models equipped with bullet turn signals. Does not fit models with plastic bullet turn signals.

Rear:

Domestic: '14-'17 FLSTF, '14-'16 FLSTFB, '16-'17 FLSTFBS, '14 FXDC, '14-'17 FXDF, FXDL, '18-'20 FXLR, '20-'21 FXLRS, '14-'19 XL1200C, '14-'17 XL1200T, '14-'19 XL883L Canada Only: '14-'16 XL1200V, '18 XL1200NS, '14-'18 XL1200X, '18 XL1200XS, '14-'18 XL883N.

International: '14-'17 FLSTF, '14-'17 FLSTFB, '16-'17 FLSTFBS, '14 FXDC, '14-'17 FXDF, '14-'17 FXDL, '14-'17 FXDWG, '18-'20 FXLR, '20-later FXLRS, '14 FXST (AUS ONLY), '14-'20 XL1200C, '14-'16 XL1200CA, '14-'17 XL1200CB, '14-'20 XL1200T, '14-'20 XL883L, '14-'15 XL883

67801186 ECE Compliant. **\$124.95**

Fits international '16-later CVO models (except non-Australian FLHTCUTGSE) equipped with LED Bullet Turn Signals. Does not fit models with plastic bullet turn signals.



A. FRONT SIGNATURE LED TURN SIGNAL INSERTS – AMBER/WHITE, SMOKED LENS



A. FRONT SIGNATURE LED TURN SIGNAL INSERTS – AMBER/WHITE, SMOKED LENS



B. FRONT SIGNATURE LED TURN SIGNAL INSERTS – AMBER/AMBER SMOKED LENS



B. FRONT SIGNATURE LED TURN SIGNAL INSERTS – AMBER/AMBER SMOKED LENS



C. REAR SIGNATURE LED TURN SIGNAL INSERT – RED



C. REAR SIGNATURE LED TURN SIGNAL INSERT – RED



D. REAR SIGNATURE LED TURN SIGNAL KIT – AMBER LIGHT - SMOKED LENS WITH CHROME HOUSING



D. REAR SIGNATURE LED TURN SIGNAL KIT – AMBER LIGHT - SMOKED LENS WITH CHROME HOUSING



D. REAR SIGNATURE LED TURN SIGNAL KIT – AMBER LIGHT - SMOKED LENS WITH BLACK HOUSING

LIGHTING 615

Turn Signals

C. REAR SIGNATURE LED TURN SIGNAL INSERT – RED

Signature LED turn signal insert with smoked lens provides a bright red run/brake/turn.

67801149 DOT Compliant. **\$124.95**
Fits domestic '16-'17 FXSE and 18-later FLSE models equipped with LED Bullet Turn Signals.

67801150 DOT Compliant. **\$118.95**
Fits domestic '18-'19 FLFB, '14-'17 FLS, '16-'17 FLSS, '18-'20 FXBB, '21 FXBBS, '18-'19 FXBR, '18-'20 FXBRS, '18-'19 FXFB, '14-'17 FXSB, '20-'21 FXST, '14-'17 FXDB, '14-'16 FXDBP, '16-'17 FXDLS, '14-'17 FXDWG, '14 FXSBSE, '16-'20 XL1200CX, '18-'21 XL1200NS (except '18 CAN), '14-'16 XL1200V (except CAN), '14-'22 XL1200X (except '14-'18 CAN), '18-'19 XL1200XS (except '18 CAN), '14-'22 XL883N (except '14-'18 CAN) and '18-later FLFBS, FLFL and FXFBS models.

67801329 DOT Compliant. **\$122.95**
Fits '20-later FLHX, FLHX, FLTRX, FLTRXS and FLHRXS models for lightbar applications. For US models only.

D. REAR SIGNATURE LED TURN SIGNAL KIT – AMBER LIGHT - SMOKED LENS WITH HOUSING

LED Turn Signals deliver modern signature style and function that improves rider conspicuity to surrounding traffic. The light pipe outer "signature" ring adds visibility and unique styling, while brilliant center LED elements flash with an eye-catching signal. Signature LED turn signal set in compact bullet-shaped housing with smoked lens provides a bright amber run/brake/turn that is ECE compliant.

Fits '14-'22 XL, '14-later Dyna® and Touring, and '14-'17 Softail® models equipped with bullet turn signals for HDI Configuration (except models with plastic bullet turn signals).

67801151 Chrome. **\$213.95**

67801152 Black. **\$213.95**

Fits international '18-'20 FLFB, '18-later FLFBS, FLSB, FLFL, '18-'20 FXBB, '21 FXBBS, '18-'19 FXBR, '18-later FXBRS, '18-'20 FXFB, '18-later FXFBS and '20-'21 FXST models.

67801326 Chrome. **\$213.95**

67801327 Black. **\$213.95**

Model Family Fitment:

V-ROD
 SPORTSTER
 DYNA

 SOFTAIL
 TOURING

Notice: The prices appearing in this catalog are the manufacturer's suggested retail prices. Actual retail prices may vary.

Notice: The prices appearing in this catalog are the manufacturer's suggested retail prices. Actual retail prices may vary.

616 LIGHTING

Turn Signals

A. LED BULLET TURN SIGNAL INSERT KIT

Grab the attention of the traffic around you. These LED Turn Signal Inserts feature a single bright, fast-acting amber or red LED lamp sealed in a waterproof housing. The multi-faceted reflector amplifies the light, and the focused lens spreads the light across the lamp's surface. The drop-in lamp assembly replaces the bulb and reflector in the stock bullet turn signal housing for a simple on-bike installation, and the included plug-in harness and crimp connectors attach directly to the existing turn signal wiring. Installation does not require a control box or load equalizer for correct operation. Kit includes 2 LED modules, 2 wiring harnesses and crimping connectors. Customize the look with your choice of outer lens cover color. Lenses sold separately. Amber Inserts are DOT/ECE compliant. Red Inserts are DOT compliant.

Fits '14-'22 XL, '12-'16 FLD and FXDC, '12-'17 FLS and FLSS, '11-'17 FLSTN and FXST, '16-'17 FLSTF, FLSTFB, FLSTFBS and FXSB, '12 FLSTSE, '18-later Softail® (except FLDE and FXDRS) and '14-later Touring and Trike models. Does not fit some international configurations with sealed LED turn signals, check with dealer to confirm.

67800639	Amber LED Insert.	\$111.95
67800640	Red LED Insert.	\$104.95

B. LENSES FOR LED BULLET TURN SIGNAL INSERTS

Add a unique touch to your bike. These Turn Signal Lens Kits replace the Original Equipment lenses when you install LED Bullet Turn Signal Inserts P/N 67800639 or 67800640. Available in amber, clear, smoked and red to match your style or functional needs. Kit contains 2 lenses.

67800642 Amber Lenses. **\$15.95**
For use with Amber LED Bullet Turn Signal Insert Kit. Fits most models with Original Equipment bullet style turn signals. Does not fit accessory LED Bullet Turn Signal Kit or models with sealed LED rear turn signals. ECE/DOT compliant.

67800643 Smoked Lenses. **\$15.95**
For use with Amber or Red LED Bullet Turn Signal Insert Kit. Fits most models with Original Equipment bullet style turn signals. Does not fit accessory LED Bullet Turn Signal Kit or models with sealed LED rear turn signals. ECE/DOT compliant with Amber insert. DOT compliant with Red insert.

67800644 Clear Lenses. **\$15.95**
For use with Amber or Red LED Bullet Turn Signal Insert Kit. Fits most models with Original Equipment bullet style turn signals. Does not fit accessory LED Bullet Turn Signal Kit or models with sealed LED rear turn signals. ECE/DOT compliant with Amber insert. DOT compliant with Red insert.

67800645 Red Lenses. **\$15.95**
For use with Red LED Bullet Turn Signal Insert Kit. Fits most models with Original Equipment bullet style turn signals or models with sealed LED rear turn signals. Does not fit accessory LED Bullet Turn Signal Kit or models with sealed LED rear turn signals. DOT compliant.



A. LED BULLET TURN SIGNAL INSERT KIT



A. LED BULLET TURN SIGNAL INSERT KIT – AMBER (SHOWN WITH CLEAR LENS)



A. LED BULLET TURN SIGNAL INSERT KIT – RED (SHOWN WITH CLEAR LENS)



B. LENSES FOR LED BULLET TURN SIGNAL INSERTS – AMBER



B. LENSES FOR LED BULLET TURN SIGNAL INSERTS – SMOKED



B. LENSES FOR LED BULLET TURN SIGNAL INSERTS – CLEAR



B. LENSES FOR LED BULLET TURN SIGNAL INSERTS – RED

Model Family Fitment:

- V-ROD
- SPORTSTER
- DYNA
- SOFTAIL
- TOURING

Notice: The prices appearing in this catalog are the manufacturer's suggested retail prices. Actual retail prices may vary.

LIGHTING 617

Turn Signals

C. LED BULLET TURN SIGNAL KIT – BLACK

Grab the attention of the traffic around you. These LED Turn Signals feature a single bright, fast-acting amber or red LED lamp sealed in a waterproof housing. The multi-faceted reflector amplifies the light, and the focused lens spreads the light across the lamp's surface. The complete lamp and housing assembly replaces the stock bullet turn signal housing, and the wiring harness connects to the existing turn signal wiring without splicing. Installation does not require a control box or load equalizer for correct operation. Kit includes 2 pre-wired LED turn signal modules mounted in black bullet housings. Customize the look with your choice of outer lens cover color. Lenses sold separately. Amber Inserts are DOT/ECE compliant. Red Inserts are DOT compliant.

67800977 Front, Amber LED. **\$266.95**
Fits '18-later FLFB, FLFBS, FLFB, FXLR and FXLRS models. Kit includes LED lamps, black housings and black turn signal mounts.

67800982 Rear Light Bar, Amber LED. **\$319.95**
Fits '18-later FLHC and FLHCS models. Kit includes LED lamps, black housings and black light bar.

D. BULLET TURN SIGNAL HOUSINGS – BLACK

Complete the blacked-out look. Kit contains two black bullet-shaped turn signal housings that have been pre-wired for installation. Just add the Original Equipment LED Turn Signal Inserts from the stock chrome housings.

67800980 Rear. **\$107.95**
Fits '18-later FLFB and '20-later FXST models. Kit includes LED lamps and black housings.



C. LED BULLET FRONT TURN SIGNAL KIT – BLACK



C. LED BULLET REAR TURN SIGNAL KITS – BLACK



C. LED BULLET TURN SIGNAL KIT – BLACK – REAR LIGHT BAR



D. BULLET TURN SIGNAL HOUSINGS – BLACK



Model Family Fitment:

- V-ROD
- SPORTSTER
- DYNA
- SOFTAIL
- TOURING

Notice: The prices appearing in this catalog are the manufacturer's suggested retail prices. Actual retail prices may vary.

618 LIGHTING

Turn Signals

A. LED FLAT LENS TURN SIGNALS

Beautiful signature light for models with Flat Lens Turn Signals. These turn signals feature fast-acting, extra bright LEDs set in low-profile die-cast chrome housings. In the front, the lights function as running light and directional indicators. In the rear, the lights function as running light, brake light and directional indicators. The front amber lights are available in your choice of smoked or amber lens and the red rear lights are offered with either smoked or red lens. Installation does not require installation of a "control box" or load equalizer and the turn signals attach directly to existing wiring without cutting or splicing. Featuring pillow-style optics, a horizontal chrome band and a Bar & Shield medallion, these signals are the perfect match for the available LED Tail Lamps. Sold in pairs. Meets DOT requirements.



A. LED FLAT LENS TURN SIGNAL – AMBER



A. LED FLAT LENS TURN SIGNAL – SMOKED



A. LED FLAT LENS TURN SIGNAL – RED



Fits '14-later Touring models equipped with flat lens turn signals.

67800374	Front, Amber Lens.	\$201.95
67800375	Front, Smoked Lens.	\$201.95

Fits '01-'17 FLSTC and '01-'13 Touring models equipped with flat lens turn signals.

68411-10	Front, Amber Lens.	\$201.95
68435-10	Front, Smoked Lens.	\$201.95

Fits '99-'17 FLSTC and '01-later Touring models equipped with flat lens turn signals.

68127-10	Rear, Smoked Lens.	\$201.95
68128-10	Rear, Red Lens.	\$201.95

B. TURN SIGNAL LENS KIT – SMOKED AND CLEAR

Add a unique touch to your bike. These Turn Signal Lens Kits replace the amber lenses for a clean front and rear appearance. Available in clear and smoked versions. Meets DOT requirements.

Fits '86-later models with Flat Turn Signal Lenses. Kit includes 4 lenses and 4 amber bulbs.

69307-02	Clear – Flat Lens.	\$43.95
69308-02	Smoked – Flat Lens.	\$43.95

C. BULLET STYLE TURN SIGNAL KIT

Streamline the styling by replacing the front and rear flat lens turn signal lamps with sleek bullet signals. The bullet-shaped housings attach to the Original Equipment turn signal mounting brackets. The kit includes two front and two rear turn signal assemblies and the necessary hardware for installation.

Fits '96-'17 FLSTC, '93-'96 FLSTN, '94-later FLHR and FLHRC, '94-'13 FLHT, FLHTC and FLHTCU and '98-'03 FLTR models.

69153-03A	Smoked Lens and Amber Bulb, Domestic.	\$149.95
------------------	---------------------------------------	-----------------



B. TURN SIGNAL LENS KIT – FLAT LENS, CLEAR



B. TURN SIGNAL LENS KIT – FLAT LENS, SMOKED



C. BULLET STYLE TURN SIGNAL KIT – FRONT, SMOKED LENS

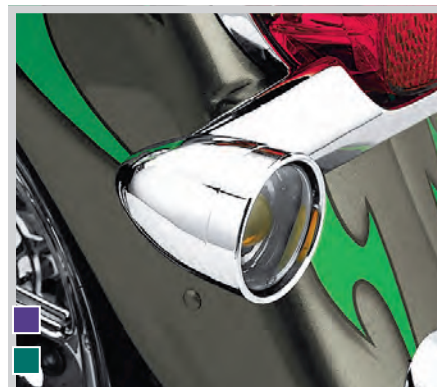

C. BULLET STYLE TURN SIGNAL KIT – REAR, SMOKED LENS



D. FRONT TURN SIGNAL RELOCATION KIT – CHROME, (68517-94A SHOWN)



D. FRONT TURN SIGNAL RELOCATION KIT – GLOSS BLACK, (68643-09 SHOWN)



D. FRONT TURN SIGNAL RELOCATION KIT – XL1200X MODELS



E. FRONT TURN SIGNAL SWIVEL ASSEMBLY KIT – CHROME

LIGHTING 619

Turn Signal Relocation Kits

D. FRONT TURN SIGNAL RELOCATION KIT

This kit includes the required hardware and wiring to move the front directional from the handlebar to the lower triple clamp.

Fits '88-'22 XL (except XL1200CX, XL1200T, XL1200X, XL1200XS and '11-'22 XL883L and XL1200C) and '91-'05 Dyna models (except FXDWG and FXDXT).

68517-94A	Chrome.	\$43.95
68643-09	Gloss Black.	\$38.95

Fits '10-'15 XL1200X models.

67800452	Satin Black.	\$62.95
-----------------	--------------	----------------

E. FRONT TURN SIGNAL SWIVEL ASSEMBLY KIT – CHROME

Add a subtle chrome detail to match your own chrome accessories with this swivel kit, a durable stylish replacement for the stock zinc-plated swivel.

68185-00 Fits '88-'03 XLH883, XLH883 Hugger™, XL1200C and XL1200S, '88-later FXR, FXRS and FXLR, '91-'08 FXDWG, '91-later FXD, FXDL, FXDX and FXDXT, '88-'17 FLS, FLSS, FLSTF, FLSTFB, FLSTFBS, FXST, FXSTB, FXSTC, FXSTD, FXSTS and FXSTSB, '18-later Softail® models (except FLDE, FLHC and FLHCS and FXLRST) and '97-'03 FLSTS models. (Does not fit with Turn Signal Relocation Kits or '03 FXSTDSE or FLHRSE.)

\$28.95

Model Family Fitment:

	V-ROD		SPORTSTER		DYNA
	SOFTAIL		TOURING		

Notice: The prices appearing in this catalog are the manufacturer's suggested retail prices. Actual retail prices may vary.

Notice: The prices appearing in this catalog are the manufacturer's suggested retail prices. Actual retail prices may vary.

620 LIGHTING

Turn Signals

A. NARROW REAR DIRECTIONAL BAR – CHROME

Enhance the rear profile of your Softail® or Touring model with this Narrow Chrome Directional Bar that enhances the visual proportions of the bike. At 10" wide, this die-cast, chrome-plated bar is 3" shorter than the stock bar and features the same great quality.

68611-98 \$58.95
Fits '86-'17 FLST and FLSTC, '93-'96 FLSTN, '09-'13 FLHTC, FLHTCU and FLHTK and '91-'08 Touring models (except '04-later FLHRS and FLTR). (Does not fit with Flat Lens Turn Signal Module P/N 91699-99A.)

B. BULLET REAR TURN SIGNAL BAR KIT – CHROME

Give your bike a new sporting attitude with the Bullet Turn Signal Kit. The chrome-plated bar and bullet turn signal housings provide a custom look and the narrow profile places the signal lamps between the saddlebag and the rear fender for a sleek appearance.

Fits '99-'08 Touring models (except FLHX), '09-'13 FLHRC, FLHTC, FLHTCU, and FLHTK models (Original Equipment on FLTRU). Also fits '99-later FLST and FLSTC models. Will not fit FLSTC models with '00-later Original Equipment Heritage Classic Saddlebags.

68615-04 Domestic. \$173.95
68617-04 International. \$168.95

C. NARROW MOUNTING KIT FOR REAR TURN SIGNALS

Tuck the rear turn signals close to the fender struts. These sleek chrome-plated turn signal mounts move the Original Equipment bullet turn signals 1" closer to the rear fender for a custom narrow profile.

69820-06 \$42.95
Fits '02-'17 FXD, FXD35, FXDB, FXDC, FXDL, FXDX, '07-'08 FXDB, '02-'05 FXDWG, '02-'17 FLSTF, FLSTFB, FLSTFBS, FLSTS and FLSTSC and '02-'05 FXST, FXSTS and FXSTB and '18-later Softail models (except FLDE, FLHC, FLHCS, FLSE, FXDRS and FXLRST). Will not fit with saddlebags or FLD rear light bar.

D. AUXILIARY BRAKE LIGHT/RUNNING LIGHT/TURN SIGNAL CONVERSION KIT*

Turn signal module adds an auxiliary brake light and running light function to your existing turn signals for auxiliary rear lighting. Red lenses glow when the headlamp is on and increase in intensity when brakes or turn signals are activated. Easy to install, the kit simply plugs into your existing wiring harness. Red turn signal lenses are included. Meets DOT requirements.

68000123A Flat Lens. \$79.95
Fits '14-later Touring models equipped with Original Equipment flat lens style turn signals.

69461-06D Flat Lens. \$78.95
Fits '96-'17 Softail® and '97-'08 Touring models (except FLHX) equipped with Original Equipment flat lens style turn signals. Also fits '09-'13 FLHR, FLHRC, FLHTC, FLHTCU and FLHTK models. (Does not fit with Narrow Chrome Directional Bar P/N 68611-98.)

69462-06D Bullet Lens. \$78.95
Fits '02-'03 XL, '02-'17 Dyna® (except FXDXT and '09-'17 FXDB and FXDWG) and '02-'17 Softail (except FXS, FXSB, FXSBSE, FXSTD and FXSTD1) models with stock bullet-style turn signals. (NOTE: Not intended for use on '05-later FLSTN, '04-later FLHRS, FLHTCSE, FLHX and FLTR or models equipped with Bullet Turn Signal Bar Kit P/N 68615-04 or 68617-04. If installed on these models, the system will function properly but will not meet the DOT minimum separation requirements for a red tail light to red turn signal.)

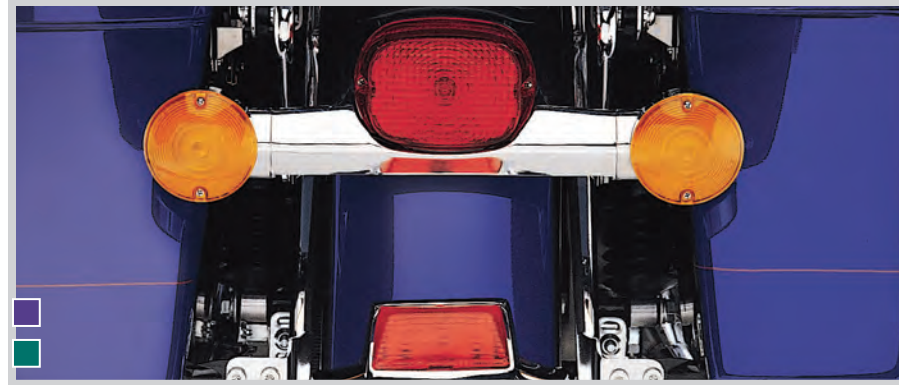

A. NARROW REAR DIRECTIONAL BAR – CHROME

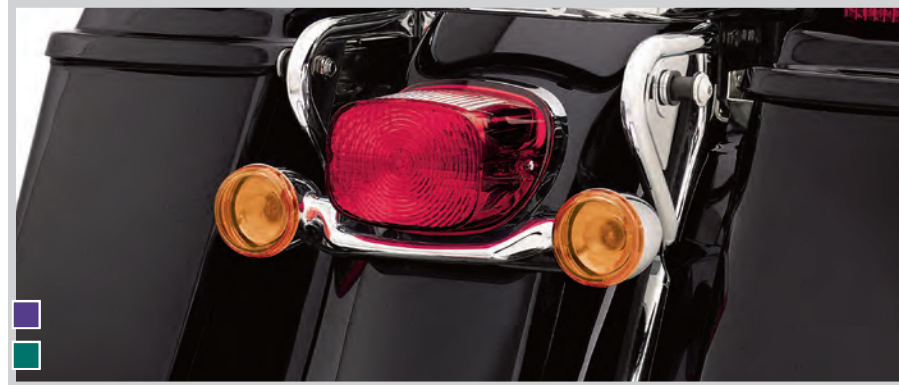

B. BULLET REAR TURN SIGNAL BAR KIT – CHROME



C. NARROW MOUNTING KIT FOR REAR TURN SIGNALS

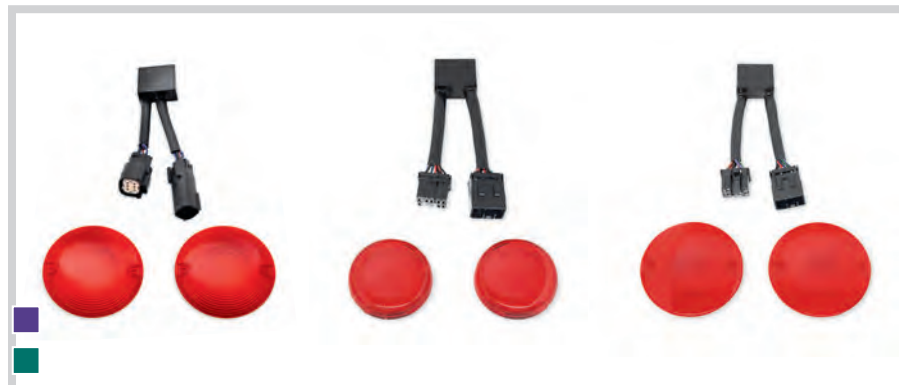

D. AUXILIARY BRAKE LIGHT/RUNNING LIGHT/TURN SIGNAL CONVERSION KIT – FLAT LENS STYLE



E. LIGHT BAR WITH LED BULLET TURN SIGNALS – BLACK WITH SMOKED LENSES



E. LIGHT BAR WITH LED BULLET TURN SIGNALS



F. BULLET REAR LIGHT BAR – GLOSS BLACK

LIGHTING 621

Rear Lighting

E. LIGHT BAR WITH LED BULLET TURN SIGNALS

These Turn Signals feature fast-acting, extra bright LEDs set in compact bullet-shaped die-cast housings. Available with red or smoked lenses, these lamps glow a bright red color when functioning as brake lamps, running lights and directional indicators. The kit includes the Rear Light Bar with integrated down-lighting for the license plate, bullet lamp housings and wiring. Installation does not require installation of a control box or load equalizer and the turn signals attach directly to existing wiring without cutting or splicing. These LED signals are the perfect match for the available LED Front Turn Signals. Meets DOT requirements.

Fits '17-later FLHRXS and '14-later FLHT, FLHX, FLHXS, FLTRX and FLTRXS models with Original Equipment rear bullet stop/turn/tail light bar.

67800493 Black – Red Lens. \$319.95
67800494 Black – Smoked Lens. \$319.95
67800492 Chrome – Smoked Lens. \$319.95

F. BULLET REAR LIGHT BAR – GLOSS BLACK

Complete the blacked-out treatment of your custom Touring bike. This complete kit replaces the Original Equipment chrome bar and lamps with a sinister black edition for a minimalistic look. The kit includes the Rear Light Bar with integrated down-lighting for the license plate, bullet lamp housings and wiring.

Fits '10-later Street Glide®, '10-later Road Glide® and '17-later FLHRXS models with Original Equipment rear bullet turn signal light bar.

67800483 Domestic. \$218.95
67800484 International. \$437.95

Model Family Fitment:

- V-ROD
- SPORTSTER
- DYNA
- SOFTAIL
- TOURING

Notice: The prices appearing in this catalog are the manufacturer's suggested retail prices. Actual retail prices may vary.

WARNING: Disconnecting your DOT-required tail, brake and turn signal lighting could reduce your visibility to others and result in death or serious injury.

Notice: The prices appearing in this catalog are the manufacturer's suggested retail prices. Actual retail prices may vary.

622 LIGHTING

Tour-Pak® & Saddlebag Lighting

SIGNATURE LED REAR LIGHTING

Signature LED Rear Lighting delivers modern style and function that improves rider conspicuity to surrounding traffic. The light pipe around the perimeter diffuses light and is always illuminated as a running light for eye-catching visibility. LED Brake and Turn lights exceed the output of Original Equipment rear lighting. These lamps offer easy plug-and-play installation that requires no wiring splicing.

A. SIGNATURE LED SADDLEBAG RUN/BRAKE/TURN LAMP

Add functional lighting to the rear of your Touring bike with these run/brake/turn lights. Lamps may act as a supplement to the Tour-Pak® luggage carrier mounted rear lighting, and also permit the removal of the Tour-Pak® luggage carrier with a Detachable Mounting Kit.

Fits '14-later Touring models equipped with standard or stretched saddlebags.

67801023	Red Lens.	\$266.95
67801024	Smoked Lens.	\$266.95

B. KEYSTONE LED RUN/BRAKE/TURN LAMP

Nestled in the fender strut opening, these Keystone LED lamps add stylish and practical lighting to the rear of the bike. When the bike is parked, the dark lamps fill the gap between the fender and saddlebags for a clean, uncluttered look. Lamps are mounted in a sealed housing that slips into the opening and are held in place with the saddlebag support hardware and an adhesive pad.

Fits '14-later FLHR, FLHTCU, FLHTCUL, FLHTK, FLHTKL, and FLTRU models.

67801080	Red Lens.	\$319.95
67801082	Smoked Lens.	\$319.95



A. SIGNATURE LED SADDLEBAG RUN/BRAKE/TURN LAMP



B. KEYSTONE LED RUN/BRAKE/TURN LAMP - RED LENS



B. KEYSTONE LED RUN/BRAKE/TURN LAMP



C. SIGNATURE LED KING TOUR-PAK® LUGGAGE CARRIER RUN/BRAKE/TURN LAMP KIT – RED LENS



C. SIGNATURE LED KING TOUR-PAK® LUGGAGE CARRIER RUN/BRAKE/TURN LAMP KIT – SMOKED LENS



D. SIGNATURE LED TOUR-PAK SIDE MARKER LIGHT KIT – RED LENS



D. SIGNATURE LED TOUR-PAK SIDE MARKER LIGHT KIT – SMOKED LENS

LIGHTING 623

Tour-Pak® & Saddlebag Lighting

C. SIGNATURE LED KING TOUR-PAK® LUGGAGE CARRIER RUN/BRAKE/TURN LAMP KIT

Sequential turn signal elements sweep outward from the center to grab the attention of other motorists and make the motorcycle more conspicuous. Offered with Smoked or Red lenses.

Fits '14-later Touring and Trike models equipped with King Tour-Pak® luggage carrier.

67801129	Red Lens.	\$372.95
67801128	Smoked Lens.	\$372.95

D. SIGNATURE LED TOUR-PAK SIDE MARKER LIGHT KIT

Replaces Original Equipment King Tour-Pak side marker lights with brilliant LED elements to complement LED Signature lighting to the rear of the motorcycle. Offered with Smoked or Red lenses.

Fits '14-later Touring and Trike models equipped with King Tour-Pak® luggage carrier.

68000312	Smoked Lens.	\$180.95
68000313	Red Lens.	\$180.95



***WARNING:** Disconnecting your DOT-required tail, brake and turn signal lighting could reduce your visibility to others and result in death or serious injury.



***WARNING:** Disconnecting your DOT-required tail, brake and turn signal lighting could reduce your visibility to others and result in death or serious injury.

Model Family Fitment:

- V-ROD
- SPORTSTER
- DYNA
- SOFTAIL
- TOURING

Notice: The prices appearing in this catalog are the manufacturer's suggested retail prices. Actual retail prices may vary.

Notice: The prices appearing in this catalog are the manufacturer's suggested retail prices. Actual retail prices may vary.

624 LIGHTING

Tail Lamps – LED

A. LAYBACK LED TAIL LAMP

Shaped to mirror the contour of the rear fender, this Layback LED Tail Light combines style and performance in one. Featuring an array of fast acting red LED lamps arranged in a grid pattern, this bright running lamp outshines traditional incandescent lamps. And when you hit the brakes, you'll grab everyone's attention. Available in your choice of red or smoked lenses, this complete tail lamp assembly features an easy plug-in connection to the Original Equipment wiring harness. Lamp meets ECE requirements.

Fits '99-'22 XL (except XL883N, XL1200CX, XL1200N, XL1200NS, XL1200V, XL1200X, XL1200XS and '11-'22 XL1200C), '99-'17 FXDL, '18-later FXLR, FLHC and FLHCS, '03-'17 FXST, FXSTB, FXSTC and FXSTS, '00-'17 FLST, FLSTC, FLSTF, FLSTFB, FLSTFBS and FLSTSB, '09-later FLHRC, FLHTC, FLHTCU, FLHTK and FLTRU and '99-'08 Touring models (except FLHX, '05 FLHTCSE, '07-'08 FLHRSE and models equipped with License Plate Relocation Kit P/N 53702-04). Does not fit models with Bobtail fenders.

67800355 Red Lens with Plate Lamp. **\$183.95**
For U.S. and Canada.

67800356 Smoked Lens with Plate Lamp. **\$183.95**
For U.S. and Canada.

67800614 Red Lens with Plate Lamp. **\$183.95**
For all markets (except U.S. and Canada).

67800615 Smoked Lens with Plate Lamp. **\$183.95**
For all markets (except U.S. and Canada).

Fits '07-'08 FLHRSE, '05 FLHTCSE, '06-'09 FLHX, '09 FLHT, '09-later FLHR (except FLHRXS), and FLTR and models equipped with License Plate Relocation Kit P/N 53702-04.

67800357 Red Lens. **\$183.95**
For U.S. and Canada.

67800358 Smoked Lens. **\$183.95**
For U.S. and Canada.

67800616 Red Lens. **\$183.95**
For all markets (except U.S. and Canada).

67800617 Smoked Lens. **\$183.95**
For all markets (except U.S. and Canada).

B. CHOPPED FENDER EDGE LIGHT

Style and function in one. This center-mount auxiliary running and brake light commands the attention of following vehicles. The bright, fast-acting LED lamp glows red when the ignition is on and intensifies when the brakes are applied. The low-profile lamp is contoured to hug the curve of the chopped rear fender and adds a stylish touch of color, even when the bike is parked.

73416-11 Red Lens. **\$95.95**
Fits '10-'17 FXDWG models.

73420-11 Red Lens. **\$95.95**
Fits '04-'13 XL883N, XL1200N, XL1200V, XL1200X and models equipped with Chopped Rear Fender Kit P/N 60236-09, 60236-10 and side-mount license plate. Will not fit models with center-mount license plates.

68000105 Red Lens. **\$107.95**
Fits '14-'22 XL883N, XL1200NS, XL1200V, XL1200X, XL1200XS and '14-later models equipped with Chopped Rear Fender Kit P/N 60236-09, 60236-10 and side-mount license plate. Will not fit models with center-mount license plates.

C. LED TAIL LAMP

Combine LED technology and contemporary styling for a bright new look. Featuring a full array of 20 fast-acting red LED lamps, this brilliant running and brake lamp will grab everyone's attention. Designed to fit the contour of both Bobtail and full rear fenders, the smoked or red lens Bar & Shield logo-accented tail lamp complements any custom direction. The black or chrome bezel is wrapped in a clear outer housing for a mirror-like finish. Easy plug-in connection to the Original Equipment wiring harness.

67800133 Red Lens/Chrome Bezel. **\$372.95**
Fits '09-later FLHTCUTG and '10-'11 FLHXXX models. Sold in pairs.



A. LAYBACK LED TAIL LAMP – SMOKED



A. LAYBACK LED TAIL LAMP – ON



A. LAYBACK LED TAIL LAMP – RED



A. LAYBACK LED TAIL LAMPS



B. CHOPPED FENDER EDGE LIGHT – DYNA WIDE GLIDE



C. LED TAIL LAMPS



D. ELECTRA GLO STEALTH AUXILIARY LED RUN/BRAKE/TURN LAMP – ON



E. TRI-BAR LIGHT UPGRADE – AUXILIARY RUNNING LIGHT/BRAKE LIGHT



F. REAR FENDER TIP LIGHT – AUXILIARY RUNNING LIGHT/BRAKE LIGHT



G. TRI-BAR LED TAIL LIGHT – ON



H. CUSTOM LED TAIL LAMP – RED LENS

LIGHTING 625

Saddlebag Lighting

D. ELECTRA GLO™ STEALTH AUXILIARY LED RUN/ BRAKE/TURN LAMPS*

Keep a low profile while drawing maximum attention. These covert lamps hug the bottom edge of the saddlebags, and provide a subtle band of red light beneath the bike when the ignition is on. To help grab the attention of following drivers, the fast-acting LED lamps increase in intensity when the brakes or turn signals are applied. Strong adhesive pads secure the water- and shock-proof housings to the bags, and the quick-release wiring harness connects to the bike's wiring without splicing. Kit includes left and right lamp and quick-disconnect wiring harness.

Fits '14-later Touring models with standard hard saddlebags. Does not fit models equipped with Original Equipment or accessory Stretched Saddlebags or with some 4.5" accessory mufflers.

67800554 Red Lens. **\$160.95**
67800555 Smoked Lens. **\$160.95**

E. TRI-BAR LIGHT UPGRADE – AUXILIARY RUNNING LIGHT/BRAKE LIGHT*

Upgrade the Original Equipment Tri-Bar fender light from a single-mode running light to a dual-mode running and brake light. The three smoked light bands glow red in the running mode and increase in intensity when the brakes are applied.

68358-07A **\$107.95**
Fits '06-'09 FLHX models.

67774-10 **\$160.95**
Fits '10-later FLHX and FLTRX models (except HDI models).

F. REAR FENDER TIP LIGHT – AUXILIARY RUNNING LIGHT/BRAKE LIGHT*

Upgrade your Touring model's Original Equipment fender tip light from a single-mode running light to a dual-mode running and brake light. The brilliant lamp glows red in the running mode and increases in intensity when the brakes are applied. The available smoked or red lenses complement any styling direction. Easy plug-in connection to the Original Equipment wiring harness.

Fits '09-'16 FLHTC, FLHTCU, FLHTCUL, FLHTK, FLHTKL and '16 FLTRU models.

59685-10 Red Lens. **\$116.95**

G. TRI-BAR LED TAIL LIGHT

The lamp assembly fills the fender opening for a custom look and the minimalist license plate bracket continues the streamlined appearance. Features easy plug-in connection to the Original Equipment wiring harness. DOT and TUV compliant.

69817-07A Smoked Lens. **\$266.95**
Fits '06-'15 FXST, FXSTB, FXSTC, FXSTS and FLSTSB models. Original Equipment on '07-'08 FXSTSSE models. Will fit with Bobtail Fender Racks P/N 53979-07A and 56452-07 when used with Installation Kit P/N 59320-07A. Does not fit with Bobtail Fender Rack P/N 56452-07, 60161-06 or 53979-07.

H. CUSTOM LED TAIL LAMP

Available with a red or clear outer lens, the installed lens adds a red metallic or chrome finishing touch to the rear fender. Featuring easy plug-in connection to the Original Equipment wiring harness. Meets DOT and TUV requirements.

69366-07 Red Lens with Chrome Reflector. **\$149.95**
Fits '02-'11 VRSC™ models (except VRSCF) and '00-'07 FXSTD models.

Model Family Fitment:

- V-ROD
- SPORTSTER
- DYNA
- SOFTTAIL
- TOURING

Notice: The prices appearing in this catalog are the manufacturer's suggested retail prices. Actual retail prices may vary.

***WARNING:** Disconnecting your DOT-required tail, brake and turn signal lighting could reduce your visibility to others and result in death or serious injury.

Notice: The prices appearing in this catalog are the manufacturer's suggested retail prices. Actual retail prices may vary.

626 LIGHTING

Tail Light Visors

A. TAIL LIGHT VISORS

Mirror-finish chrome visor dresses the tail light in style. Available in your choice of design, this easy-to-install visor adds a finishing touch.

Fits '73-later models (except Revolution® Max, VRSC™, XG, XR, XL883N, XL1200CX, XL1200N, XL1200NS, XL1200SX, XL1200V, XL1200X, FXDF, FXDLS, FXDWG, FXWG, FLS, FLSE, FLSS, FLSTN, FLSTS, FLSTSB, FX Softail®, FXSE, FLHX, FLHTCUTG, FLRT, FLTRX, FLTRXS, FLHXST, FLTRXST and FLTRXSE, '11-'22 XL1200C, '09-'17 FXDB, '14-later FLHXS, FLTRXSE, FLHRSE and FLHTKSE and '09-later FLHR and FLTR models).

68006-83T	Classic Chrome.	\$25.95
68011-91T	Eagle Wing Gold.	\$35.95



A. TAIL LIGHT VISOR – CLASSIC CHROME



A. GOLD TAIL LIGHT VISOR – EAGLE WING

B. TAIL LIGHT COLLAR – CHROME

This chrome-plated ABS tail light collar dramatically changes the appearance of your rear fender. The collar is easy to install and the kit includes all mounting hardware.

68311-01 \$39.95

Fits '73-later models (except Revolution® Max, VRSC™, XG, XR, XL883N, XL1200CX, XL1200N, XL1200NS, XL1200SX, XL1200V, XL1200X, FXDF, FXDLS, FXDWG, FXWG, FLS, FLSE, FLSS, FLSTN, FLSTS, FLSTSB, FX Softail®, FXSE, FLHX, FLHTCUTG, FLRT, FLTRX, FLTRXS, FLHXST, FLTRXST and FLTRXSE, '11-'22 XL1200C, '09-'17 FXDB, '14-later FLHXS, FLTRXSE, FLHRSE and FLHTKSE and '09-later FLHR and FLTR models).

68332-08 \$39.95

Fits '06-'09 FLHX and '09-later FLHR, FLHRC and '06-'09 FLTR and FLHTCUTG models with Original Equipment tail lamp. Also fits Touring models equipped with Bullet Turn Signal and License Plate Relocation Kit P/N 53702-04A.

C. CURVED LICENSE PLATE FRAME – SOFTAIL® DELUXE

Love the look of your bike but hate the appearance of your state-mandated license plate? This stylish Curved License Plate Frame is shaped to hug the contour of the rear fender and layback design reduces the "in-your-face" look of the flat, unfinished plate. Designed to replace the upright license plate mount, the front frame cover hides the plate's holes and raw edges and the solid backing plate conceals the unfinished rear side of the plate. Available in chrome, the complete kit includes all required mounting hardware.

67900007 Chrome. **\$107.95**
Fits '05-'17 FLSTN and '05-'07 FLSTSC models.



B. TAIL LIGHT COLLAR – CHROME



C. CURVED LICENSE PLATE FRAME – SOFTAIL DELUXE, CHROME

D. LAYBACK LICENSE PLATE AND TURN SIGNAL RELOCATION KIT

This kit combines our popular Layback License Plate Mount with an integrated turn signal bar to add a stylish slant to the rear fender. Kit relocates the Original Equipment bullet-style turn signals from the fender strut to the turn signal bar to allow clearance for saddlebags. This kit is a stylish alternative to Turn Signal Relocation Kit P/N 68732-02A and includes all necessary mounting hardware.

60215-06 \$100.95
Fits '04-'22 XL (except XL883N, XL1200C, XL1200CX, XL1200N, XL1200NS, XL1200T, XL1200V, XL1200X and XL1200XS) and '02-'17 Dyna® models (except FLD, FXDF, FXDWG and '09-'17 FXDB). Does not fit models equipped with side-mount license plates.



D. LAYBACK LICENSE PLATE AND TURN SIGNAL RELOCATION KIT



E. CURVED LICENSE PLATE FRAME WITH LED LIGHTING – CHROME



E. CURVED LICENSE PLATE FRAME WITH LED LIGHTING – GLOSS BLACK



F. CURVED LICENSE PLATE FRAME – TOURING, CHROME



F. CURVED LICENSE PLATE FRAME – TOURING, GLOSS BLACK



G. LAYBACK LICENSE PLATE MOUNT – FENDER TOP



G. LAYBACK LICENSE PLATE MOUNT – TOURING

LIGHTING 627

License Plate Frames & Mounts

E. CURVED LICENSE PLATE FRAME WITH LED LIGHTING

Dress up the rear of your Street Glide® or Road Glide® model and add practical auxiliary lighting at the same time. Designed to replace the Original Equipment black license plate bracket, this curved license plate frame is shaped to hug the contours of the rear fender. The mount attaches to the underside of the rear turn signal bar, and the smooth license plate frame with signature Harley-Davidson script appears to float above the fender for a custom look. The frame features two vertical LED halo lights that glow while in the run mode and burn brightly when the brakes are applied. Kit includes all necessary harnesses and connectors to enable complete installation – no drilling or wire splicing is required. Available in your choice of chrome or gloss black finish.

Fits '10-later FLHRXS, FLHX, FLHXS, FLHXST, FLTRX, FLTRXS and FLTRXST models.

67900275	Chrome.	\$170.95
67900273	Gloss Black.	\$170.95

F. CURVED LICENSE PLATE FRAME – TOURING

Love the look of your bike but hate the appearance of your state-mandated license plate? This stylish Curved License Plate Frame is shaped to hug the contour of the rear fender. Designed to replace the Original Equipment black license plate bracket, installation requires no drilling or rewiring. The front frame cover conceals the plate's mounting holes and raw edges and the curved shape hides the unfinished rear side of the plate. Available in chrome or gloss black finish, the complete kit includes all required mounting hardware.

Fits '10-later FLHRXS, FLHX, FLHXS, FLHXST, FLTRX, FLTRXS and FLTRXST models.

67900008	Chrome.	\$100.95
67900058	Gloss Black.	\$100.95

Fits '09, FLHR, FLHT and FLTR and '06-'08 FLHX models.
67900056 Chrome. **\$100.95**

G. LAYBACK LICENSE PLATE MOUNT

Showcase your laid-back attitude by replacing the stand-up license plate mount. Chrome-plated die-cast mount tips the license plate back for a low-profile style. Kit accepts plates measuring to 7.25" x 4.25" (184 x 108mm). Kit includes chrome-plated license mounting hardware, installation hardware and rear fender reflector.

60280-07 Fender Top. **\$54.95**
Fits license plate up to 7-1/4" x 4-1/4". Fits models with a three-hole rear fender mount license plate bracket. (Does not fit VRSC™, XL883N, XL1200CX, XL1200N, XL1200NS, XL1200T, XL1200V, XL1200X, XL1200XS, FLD, FXDS-CONV, FXDXT, FLSTS, FXCW, FXCWC, RA1250, RA1250S, Touring, Trike, models with a Bobtail Rear Fender, '00-'01 FXDX, '11-'22 XL1200C, '09-'17 FXDB, '18-later Softail® and '10-'17 FLS, FLSS, FXDWG, FXS, FXSB and FXSBSE models). (Check for clearance before installing with rear fender rack.)

60277-07 Touring. **\$48.95**
Fits '99-'08 Road King®, Road Glide® and Electra Glide® Standard models with 7.25" x 4.25" license plate.

Model Family Fitment:

■ V-ROD	■ SPORTSTER	■ DYNA
■ SOFTAIL	■ TOURING	

Notice: The prices appearing in this catalog are the manufacturer's suggested retail prices. Actual retail prices may vary.

Notice: The prices appearing in this catalog are the manufacturer's suggested retail prices. Actual retail prices may vary.

628 LIGHTING

License Plate Frames & Mounts

A. HARLEY-DAVIDSON® LICENSE PLATE FRAME

Make your plate shine with this chrome-plated license plate frame, featuring a black paint-filled Harley-Davidson logo. Includes chrome-plated stainless steel mounting hardware.

60051-01 **\$28.95**
Fits 7.25" x 4.25" license plates (except XR, '14-later Touring, '09-later Trike, and models equipped with layback license plate mounting kits or side-mount license plates).

B. HARLEY-DAVIDSON SCRIPT LICENSE PLATE FRAME

If a license plate is required, you might as well make it look good. This decorative, chrome-plated license plate frame has three-dimensional twist contours, a black Harley-Davidson script and a DOT compliant reflector. Stainless steel mounting hardware included.

59141-98 **\$30.95**
Fits 7.25" x 4.25" license plates (except XR, FXDLS, FXSE, '14-later Touring models, '09-later Trike, and models equipped with layback license plate mounting kits or side-mount license plates).

C. LICENSE PLATE FRAME

Fits 7.25" x 4.25" license plates (except XR, XL883N, XL1200CX, XL1200V, XL1200X, FXBB, FLSL, FXFB, FXFBS, FLFB, FLFBS, FXBR, FXBRS, FXDB, FXDF, FXDLS, FXCW, FXCWC, FXSB, FXSE, RH975, Trike and '10 FXDWG models). Black frame includes black mounting hardware.

67900653 Chrome. **\$20.95**
67900645 Black. **\$26.95**

D. SKULL LICENSE PLATE MOUNTING HARDWARE

Leave them looking at your "attitude." This complete license plate hardware kit features chrome-plated skull-shaped bolts with sinister black-filled eyes. The hardware is installed with a special open wrench to reduce the possibility of license plate theft. Kit includes 4 skull bolts, nuts, lock washers and the special wrench.

94546-05 Universal (except FLHTCUTG). **\$31.95**

E. BAR & SHIELD LOGO LICENSE PLATE MOUNTING HARDWARE KIT

Proudly display the Bar & Shield. The Bar & Shield logo shaped bolt heads on this unique chrome-plated stainless steel License Plate Mounting Kit stand out from the pack. The hardware is installed with a custom Bar & Shield logo shaped wrench, reducing the possibility of license plate theft. The kit includes 4 lock nuts, washers, bolts and the special wrench.

94114-02 Universal (except FLHTCUTG). **\$25.95**

F. WILLIE G SKULL COLLECTION LICENSE PLATE HARDWARE KIT

Your bike has an attitude front to back and the final view they see should reflect it. This chrome-plated hardware kit features a skull logo set off by a black background. Sold in sets of 4, includes .25"-20 x .75" fasteners with lock nuts and washers.

41170-03 Universal (except FLHTCUTG). **\$25.95**

G. BAR & SHIELD LOGO LICENSE PLATE HARDWARE KIT

This chrome-plated hardware kit features the Bar & Shield logo set against a gloss black background. Kit includes a set of four .25"-20 x .75" fasteners with matching lock nuts and washers.

41161-01 Universal (except FLHTCUTG). **\$25.95**



A. HARLEY-DAVIDSON LICENSE PLATE FRAME



B. HARLEY-DAVIDSON SCRIPT LICENSE PLATE FRAME

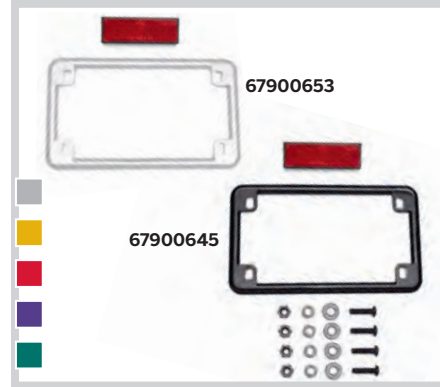

C. LICENSE PLATE FRAME



D. SKULL LICENSE PLATE MOUNTING HARDWARE



E. BAR & SHIELD LOGO LICENSE PLATE MOUNTING HARDWARE KIT



F. WILLIE G SKULL COLLECTION LICENSE PLATE HARDWARE KIT



G. BAR & SHIELD LOGO LICENSE PLATE HARDWARE KIT

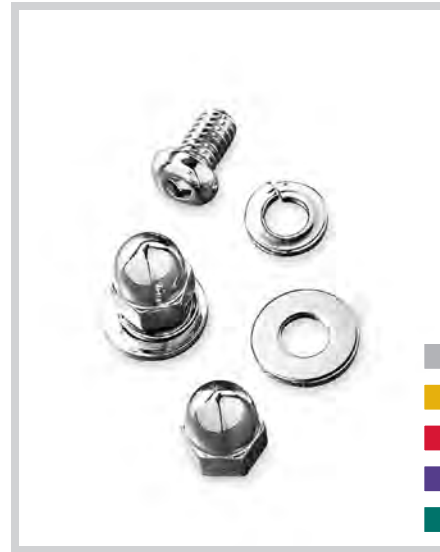

H. LICENSE PLATE MOUNTING KIT WITH BUTTON HEAD SCREWS

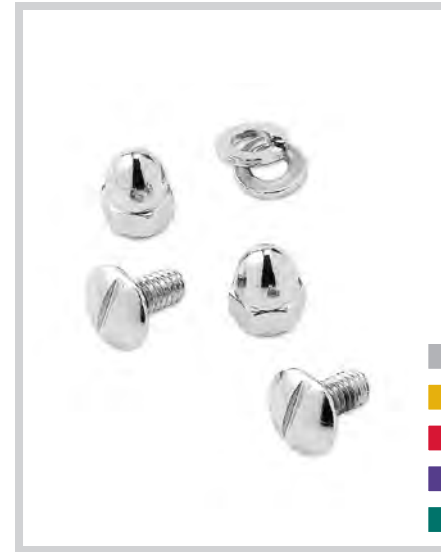

I. LICENSE PLATE MOUNTING KIT



J. LOUD SIDE-MOUNT HORN KIT



K. LOUD HORN KIT - CHROME



K. LOUD HORN KIT - GLOSS BLACK

LIGHTING 629

Horns

H. LICENSE PLATE MOUNTING KIT WITH BUTTON HEAD SCREWS

Kit contains two chrome button head screws, two chrome acorn nuts, two chrome flat washers and two chrome lock washers.

94109-95 Universal fitment. **\$8.95**

I. LICENSE PLATE MOUNTING KIT

Kit contains two chrome .25" acorn nuts, two chrome .25"-20 screws and two chrome .25" lockwashers.

94135-93T Universal fitment. **\$6.95**

J. LOUD SIDE-MOUNT HORN KIT

Get noticed. Ride with increased confidence with a loud horn that will grab everyone's attention. Engineered to be 5dB louder (at 2 meters) than the '13-earlier Original Equipment side-mounted horn. The loud horn is stock on '14-later models equipped with side-mount horns. Designed to be a plug-in replacement that is easy to install. Fits all H-D® side-mount horn covers.

69060-90H **\$54.95**
Fits '91-'17 VRSC™, '91-'22 XL1200C and XL1200V, '91-'17 Dyna® (except '14-'17 FXDL), '91-'17 Softail® (except FLSTS, FLSTSC, FXCW, FXCWC, FXS, FXSB and FXSBSE), '91-later Touring and '09-later Trike models.

K. LOUD HORN KIT

Grab everyone's attention. Engineered to be 3dB louder (at 2 meters) than the Original Equipment front-mounted horn, this Horn Kit is tuned to a frequency that helps cut through the background noise. Designed to be a plug-in replacement for the factory horn, this easy-to-install option is available in your choice of brilliant chrome or gloss black finish. The traditional Bar & Shield logo adds a classic finishing touch.

Fits '96-'22 XL and '08-'13 XR models with front-mount horn.
69000007 Chrome. **\$33.95**
69000009 Gloss Black. **\$33.95**

Model Family Fitment:

- V-ROD
- SPORTSTER
- DYNA
- SOFTAIL
- TOURING

Notice: The prices appearing in this catalog are the manufacturer's suggested retail prices. Actual retail prices may vary.

Notice: The prices appearing in this catalog are the manufacturer's suggested retail prices. Actual retail prices may vary.

630 LIGHTING

Horns

A. HORN COVER – BLACK MACHINE CUT

Add some edgy custom detail and express big attitude with contrasting style. Durable billet aluminum with rich black finish. Deep machine cut grooves expose bright aluminum and add edgy detail. Easy custom detail that hides the horn. Easy to install with included mounting hardware. Complete this custom look with additional edge cut accessories.

61301177 **\$78.95**
Fits '93-later models with side-mounted horn (except VRSC™ and XG models).

B. WILLIE G SKULL COLLECTION HORN COVER – BLACK

As vast and infinite as your style, these Willie G Skull Collection Accessories are drenched in rich obsidian black and let you take the blacked-out look to a whole new level. The menacing dimensional skull and surrounding Harley-Davidson Motorcycles script add just the right touch of attitude to their clean, dark as night backdrops. Styled to complement other Willie G Skull Collection Accessories, this Round Horn Cover features a cast 3-dimensional Willie G Skull with surrounding Harley-Davidson Motorcycles script. This kit re-uses Original Equipment horn and mounting hardware.

61301045 **\$78.95**
Fits '93-later models with side-mounted horn (except VRSC™ and XG models). Not available in India or China markets.

C. DARK CUSTOM LOGO HORN COVER

The famous Harley-Davidson #1 logo with a sinister twist. This horn cover is coated in gloss black and features a machined aluminum Dark Custom logo recessed in the face. The look complements other Dark Custom collection accessories, or is a perfect stand-alone addition to a completely blacked-out ride. The oval horn cover features a deep drawn steel chamber to maintain horn tone and volume. Simple to install, this kit re-uses Original Equipment horn and mounting hardware.

61300621 **\$78.95**
Fits '93-later models with side-mounted horn (except VRSC and XG models).

D. GLOSS BLACK HORN COVER

This Horn Cover Kit is the perfect start in converting your powertrain to a striking blacked-out look. Manufactured from Original Equipment components, this cover is painted alongside our other components to ensure a matching black finish. Simple to install, this kit re-uses Original Equipment horn and mounting hardware.

Fits '93-later models with side-mounted horn (except VRSC and XG models).

61300623 Waterfall Style. **\$58.95**
61300452 Cowbell Style. **\$47.95**

E. WRINKLE BLACK HORN COVER

This powder coated horn cover is the perfect start in converting your powertrain to a striking blacked-out look. Manufactured from Original Equipment components, this cover is painted on the factory production line to ensure a matching wrinkle black finish.

69039-09A **\$47.95**
Fits '93-later models with side-mounted horn (except VRSC and XG).



A. BLACK MACHINE CUT HORN COVER



B. WILLIE G SKULL COLLECTION HORN COVER – BLACK



F. WILLIE G SKULL COLLECTION HORN COVER – CHROME

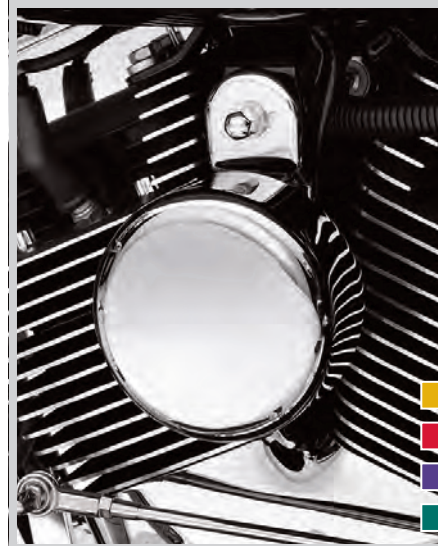

G. SMOOTH HORN COVER



C. DARK CUSTOM LOGO HORN COVER



D. GLOSS BLACK HORN COVER – WATERFALL STYLE



H. BAR & SHIELD LOGO HORN COVER



I. SIDE-MOUNT HORN KIT – CHROME



D. GLOSS BLACK HORN COVER – COWBELL STYLE

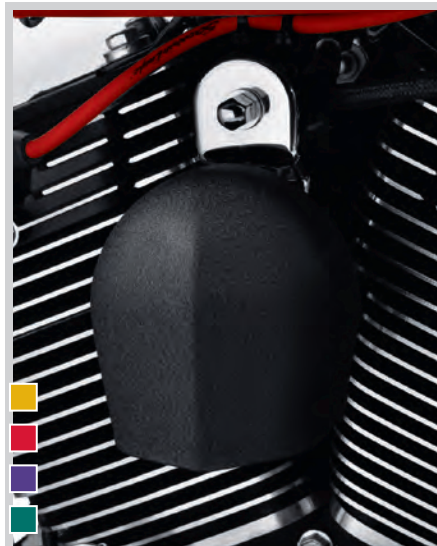

E. WRINKLE BLACK HORN COVER



J. CLASSIC HORN



LIGHTING 631

Horns

F. WILLIE G SKULL COLLECTION HORN COVER – CHROME

Styled to complement the components of the Willie G Skull Collection, this round chrome finished horn cover features a cast 3-dimensional medallion with black-filled detailing. This kit re-uses Original Equipment horn and mounting hardware.

61300622 **\$78.95**
Fits '93-later models with side-mounted horn (except VRSC™ and XG models). Not available in India or China markets.

G. SMOOTH HORN COVER

Add a custom touch to your ride. Styled to complement the Smooth Air Cleaner Cover P/N 29153-07, this compact round horn cover features a mirror chrome finish. Mounts easily to the stock horn cover bracket.

68189-07A **\$44.95**
Fits '93-later models with side-mounted horn (except VRSC™ and XG).

H. BAR & SHIELD LOGO HORN COVER

Complement your engine fins with this chrome-plated horn cover with engraved inserts, which feature a Bar & Shield emblem accented by a black background. Easily mounts to stock horn bracket.

69166-01B **\$53.95**
Fits '93-later models with side-mounted horn (except VRSC and XG).

I. SIDE-MOUNT HORN KIT – CHROME

Convert your stock Sportster® horn to the look of a Big Twin.

69112-95E **\$112.95**
Fits '92-'22 XL883, XL883C, XL883H, XL883L, XL883N, XL833R, XL1200, XL1200CX, XL1200L, XL1200N, XL1200R, XL1200V and XL1200X and '08-'13 XR models.

J. CLASSIC HORN

Early style 12V horn features nostalgic Harley-Davidson Bar & Shield logo on chrome cover. To be used as an auxiliary horn only. Do not disconnect your Original Equipment horn.

69036-88A **\$137.95**
Fits '88-'06 FXSTS models. Includes chrome mounting bracket and acorn nuts.

Model Family Fitment:

V-ROD
 SPORTSTER
 DYNA
 SOFTAIL
 TOURING

Notice: The prices appearing in this catalog are the manufacturer's suggested retail prices. Actual retail prices may vary.

Notice: The prices appearing in this catalog are the manufacturer's suggested retail prices. Actual retail prices may vary.

LIGHTING



Road Glide® Limited - H-D® Prodigy™ Custom Wheel - Gloss Black

HARLEY-DAVIDSON®

WHEELS

Make a definitive style statement. Whether you're going for an old-school or new-school look, this is where you set the tone. You'll ride comfortably knowing that Harley-Davidson wheels meet the highest standards of performance and durability.

634 WHEELS

Combo Cast Laced Wheel Kit

A. COMBO CAST LACED WHEEL KIT- 21" FRONT /18" REAR WHEEL KIT FOR ROAD GLIDE® MODELS

Think big, Road Glide® motorcycle riders. Our new Combo custom wheels feature laced spokes that exit outside the cast aluminum rim for a new look that is both rugged and very exclusive. This 21/18-inch wheel kit is only for Road Glide models and includes internal front suspension components to optimize fork travel and ride quality. You get radical big-wheel style without compromising touring performance and reliability. Contrast Chrome and Gloss Black wheel finish. Laced spokes and cast-aluminum rims. Kit includes 21" front wheel, 18" rear wheel and the internal front suspension components necessary to optimize fork travel and ride quality. Enables TPMS (tire pressure monitoring systems) on a laced wheel. Required installation Kit, 21" fender and brake rotors sold separately. Dealer installation required. See dealer for details.

42400045 Contrast Chrome/Gloss Black. **\$2,364.95**
Fits '17-later FLTRX, FLTRXS and FLTRXST models. Does not fit models equipped with Fairing Lower. Can be installed with Chopped Engine Guard P/N 49000117A. Requires separate purchase of TPMS sensor P/N 42300145, except Japan models require P/N 42300146, and valve cap P/N 42300093 for '20-later FL bikes equipped with TPMS. Requires separate purchase of 21" Front Fender, Front Tire P/N 43100008, Rear Tire P/N 43200045 and model-specific Wheel Installation Kits. May require purchase of brake rotors. Models with ABS brakes require ABS recalibration. Dealer installation required. See dealer for details.

Also available:

COMBO CAST LACED WHEELS

Hit them with this Combo punch for knockout style on a CV0™ Road Glide® model. The radical Combo wheel combines laced spokes that exit outside the cast aluminum rim for a new look that is both rugged and very exclusive. Contrast Chrome and Gloss Black wheel finish. Laced spokes and cast-aluminum rims. Enables TPMS (tire pressure monitoring systems) on a laced wheel.

43300888 21" Front. **\$893.95**
Fits '18-later FLTRXSE models. '18-'20 FLTRXSE models require separate purchase of TPMS Sensor P/N 42300145 (Dom and HDI) or 42300145 (Japan).

40900871 18" Rear. **\$893.95**
Fits '18-later FLTRXSE models. '18-'20 FLTRXSE models require separate purchase of TPMS Sensor P/N 42300145 (Dom and HDI) or 42300145 (Japan).

Also available:

COLOR-MATCHED 21" FRONT FENDER

Fits '17-later FLTRX and FLTRXS models equipped with Knockout Wheel Kit P/N 43300494 or 43300496 or Combo Cast Laced Wheel Kit P/N 42400045.

See the Color Shop section for all of the available color-matched 21" front fenders.



A. COMBO CAST LACED WHEEL KIT

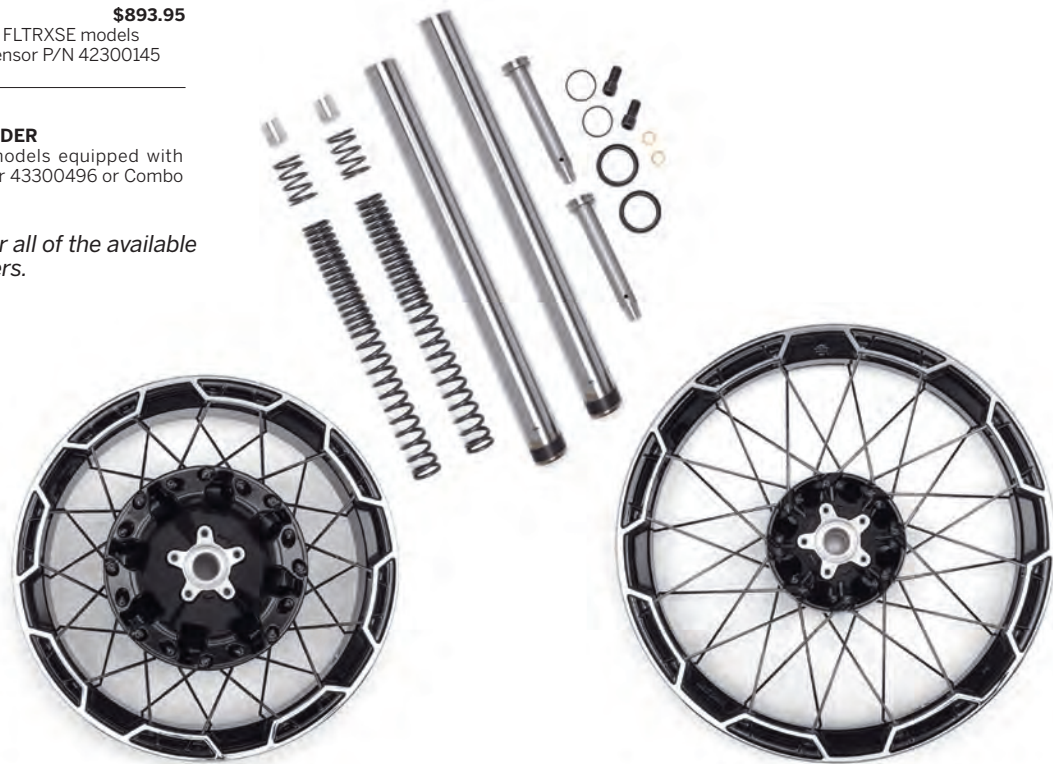

A. COMBO CAST LACED WHEEL KIT - FOR ROAD GLIDE MODELS

*NOTE: Requires separate purchase of model-specific Wheel Installation Kit, Sprocket hardware and Brake Rotor-specific hardware. See I-sheet for details. Installation may require separate purchase of wheel size and model-specific tire.

Notice: The prices appearing in this catalog are the manufacturer's suggested retail prices. Actual retail prices may vary.



B. KNOCKOUT CUSTOM WHEEL - CONTRAST CHROME



B. KNOCKOUT CUSTOM WHEEL - GLOSS BLACK/ANODIZED BLACK



B. KNOCKOUT CUSTOM WHEEL KIT - GLOSS BLACK/ANODIZED BLACK (SHOWN WITH TURBINE FLOATING BRAKE ROTOR AND 21" FRONT FENDER)

WHEELS 635

Knockout™ Custom Wheel Kit

B. KNOCKOUT™ CUSTOM WHEEL KIT

The perfect one-two styling punch for your custom Road Glide® model. Knockout™ 21" front and 18" rear wheels feature a split seven-spoke design that provides an open and airy look, with the spokes blending into the rim to add visual diameter. Kit includes 21" front wheel, 18" rear wheel and the internal front suspension components necessary to optimize fork travel and ride quality. Available in gloss black with black anodizing or contrast chrome finishes, the Knockout wheel kit provides the big wheel look you crave, without compromising touring performance and reliability.

Fits '17-later FLTRX and FLTRXS models. Does not fit models equipped with Fairing Lower, Road Glide Chizeled Handlebars or Road Glide Chizeled Lo Handlebars. Can be installed with Chopped Engine Guard P/N 49000117A. Requires separate purchase of 21" Front Fender, Front Tire P/N 43100008, Rear Tire P/N 44006-09 and model-specific Wheel Installation Kits. May require purchase of brake rotors. Models with ABS brakes require ABS recalibration. Dealer installation required. See dealer for details. '20-later models equipped with TPMS require separate purchase of Sensor P/N 32700096 (Dom and HDI) or 32700097 (Japan) and Valve Cap P/N 42300093 and Digital Tech activation.

43300494A Contrast Chrome. **\$2,415.95**
43300496A Gloss Black/Anodized Black. **\$2,388.95**

Also available:

TURBINE FLOATING BRAKE ROTORS

Complete the custom look with floating brake rotors, styled to complement Original Equipment or custom wheels. Floating rotors feature a steel inner carrier that is shaped to accent the wheel, with a drilled stainless steel outer disc that is precision-riveted in place. Rotors are sold individually and include chrome installation hardware.

Fits '14-'22 XL, '06-'17 Dyna® (except FXDLS), '15-later Softail® (except FXSE), '08-later Touring and '09-later Trike models with Original Equipment or accessory wheel with 3.25" bolt circle rotor mount.

41500147 Gloss Black Inner. **\$288.95**
41500120 Polished. **\$288.95**

Also available:

COLOR-MATCHED 21" FRONT FENDER

Fits '17-later FLTRX and FLTRXS models equipped with Knockout Wheel Kit P/N 43300494 or 43300496 or Combo Cast Laced Wheel Kit P/N 42400045.

See the Color Shop section for all of the available color-matched 21" front fenders.

Model Family Fitment:

V-ROD
 SPORTSTER
 DYNA

 SOFTAIL
 TOURING

Notice: The prices appearing in this catalog are the manufacturer's suggested retail prices. Actual retail prices may vary.

636 WHEELS

Custom Wheels

A. H-D® PRODIGY™ CUSTOM WHEELS*

Turn up the excitement level on your Touring family motorcycle with these performance-minded custom wheels. Inspired by European GT race wheels, they boast a leading-edge design that's sure to stand out, wherever you ride. Whether you're headed across town or across the country, they deliver a fresh, exciting look, guaranteed to turn heads and get you noticed.

19" Front

Fits '14-later Touring models (except CVO™ models unless originally equipped with H-D® Prodigy™ wheels).

43300673	Gloss Black.	\$784.95
43300674	Bronze.	\$814.95

18" Rear

Fits '14-later Touring models (except CVO models unless originally equipped with H-D Prodigy wheels).

40900661	Gloss Black.	\$784.95
40900662	Bronze.	\$814.95

B. FUGITIVE™ WHEELS*

Get the leading-edge style you've been chasing. Featuring a sleek double-spoke design with 14 spokes on each side, the Fugitive™ Wheel delivers a refined profile that pops with eye-catching visual depth and dimension when viewed from an angle. The result is a stunning, one-of-a-kind look. Available in gloss black and contrast chrome finishes, it will give your bike the custom style it needs to stand out from the crowd.

19" Front

Fits '14-later Touring models (except CVO™ models unless originally equipped with Fugitive wheels).

43300668	Gloss Black.	\$784.95
43300672	Contrast Chrome.	\$814.95

18" Rear

Fits '14-later Touring models (except CVO™ models unless originally equipped with Fugitive wheels).

40900650	Gloss Black.	\$762.95
40900660	Contrast Chrome.	\$838.95



Gloss Black

A. H-D PRODIGY CUSTOM WHEELS



Gloss Black

B. FUGITIVE WHEELS



C. TOMAHAWK CUSTOM WHEEL – CONTRAST CHROME – GLOSS BLACK/BLACK ANODIZED



C. TOMAHAWK CUSTOM WHEEL – GLOSS BLACK/BLACK ANODIZED

WHEELS 637

Custom Wheels

C. TOMAHAWK™ CUSTOM WHEELS*

This premium cast aluminum Tomahawk™ Wheel features five-spoke design for an open, airy look. Wheel comes in Contrast Chrome or Gloss Black Anodized with Highlights.

19" Front

Fits '14-later Touring models (except CVO™ models unless originally equipped with Tomahawk wheels). '20-later models equipped with TPMS require separate purchase of Sensor P/N 32700096 (Dom and HDI) or 32700097 (Japan) and Valve Cap P/N 42300093 and Digital Technician™ activation.

43300642A	Gloss Black/Black Anodized.	\$788.95
------------------	-----------------------------	-----------------

19" Front

Fits '19-later FLRT, FLHTCUTG, FLRT and FLHTCUTGSE models. FLRT and FLHTCUTG models require separate purchase of Tower Mount Rotors: (2) P/N 41500094 (polished kit with chrome hardware) or (2) P/N 41500017 Rotors, (10) P/N 41500020 Screws, (10) P/N 41500018 Bushing and (10) P/N 41500019 Spring. FLHTCUTG models (except China) also require separate purchase of Tire P/N 43100045.

40900624A	Gloss Black Highlighted.	\$796.95
------------------	--------------------------	-----------------

18" Rear

Fits '19-later FLRT, FLHTCUTG, FLRT and FLHTCUTGSE models. FLRT and FLHTCUTG models require separate purchase of Tire P/N 43200046.

40900651	Gloss Black Highlighted.	\$823.95
-----------------	--------------------------	-----------------

Fits '14-later Touring models (except CVO™ models unless originally equipped with Tomahawk wheels). '20-later models equipped with TPMS require separate purchase of Sensor P/N 32700096 (Dom and HDI) or 32700097 (Japan) and Valve Cap P/N 42300093 and Digital Technician activation.

40900624A	Gloss Black/Black Anodized.	\$796.95
------------------	-----------------------------	-----------------

*NOTE: Requires separate purchase of model-specific Wheel Installation Kit, Sprocket hardware and Brake Rotor-specific hardware. See I-sheet for details. Installation may require separate purchase of wheel size and model-specific tire.

Notice: The prices appearing in this catalog are the manufacturer's suggested retail prices. Actual retail prices may vary.

*NOTE: Requires separate purchase of model-specific Wheel Installation Kit, Sprocket hardware and Brake Rotor-specific hardware. See I-sheet for details. Installation may require separate purchase of wheel size and model-specific tire.

Model Family Fitment:

- V-ROD
- SPORTSTER
- DYNA
- SOFTAIL
- TOURING

Notice: The prices appearing in this catalog are the manufacturer's suggested retail prices. Actual retail prices may vary.

638 WHEELS

Enforcer & Impeller

A. ENFORCER CUSTOM WHEELS*

Bring on the bling! Add a custom touch without changing the distinctive style of your Touring motorcycle. These 100% polished and mirror chrome plated versions of the split 5-spoke Original Equipment cast aluminum wheels broadcast stunning reflections, even while standing still. These wheels have undergone hundreds of hours of real-world testing to meet the highest standards of performance and durability.

19" Front

43300336 **\$734.95**
Fits '09-later Touring models (except models equipped with TPMS and '12-later CVO™ models). Does not fit Trike models.

43300324 **\$734.95**
Fits '09-later Trike models. Does not fit CVO models.

16" Rear

40900346 **\$734.95**
Fits '09-later Touring models (except '12-later CVO models). Does not fit Trike models.

15" Rear – Trike

40900070 **\$734.95**
Fits '09-later Trike models. Does not fit CVO models.

B. IMPELLER CUSTOM WHEELS*

Shift into a higher gear. Add a custom touch of chrome without changing the distinctive style of your Touring motorcycle. These custom finished versions of the 10-spoke Original Equipment cast aluminum wheels are the perfect marriage of tough and mechanical. Available in a 100% polished brilliant mirror chrome or contrast chrome finishes, these wheels have undergone hundreds of hours of real-world testing to meet the highest standards of performance and durability.

17" Front

43300386 Contrast Chrome. **\$757.95**
Fits '09-later Touring models (except models equipped with TPMS and '12-later CVO™ models). Does not fit Trike models.

16" Rear

40900391 Contrast Chrome. **\$757.95**
Fits '09-later Touring models (except models equipped with TPMS and '12-later CVO models). Does not fit Trike models.



A. ENFORCER CUSTOM WHEELS



C. TURBINE CUSTOM WHEELS – GLOSS BLACK



B. IMPELLER CUSTOM WHEELS – CONTRAST CHROME



D. AGITATOR CUSTOM WHEELS – MIRROR CHROME

WHEELS 639

Turbine

C. TURBINE CUSTOM WHEELS*

Bring the gleam and add some edge. These cast aluminum Turbine-style wheels feature 21 spokes, which extend all the way to the edge of the rim, creating the illusion of a larger wheel diameter. The visually stunning wheels are meticulously polished and painted gloss black or chrome-plated for maximum reflective effect. All Genuine Motor Accessory wheels have been certified by Harley-Davidson to perform to our tough vehicle standards for quality and durability. Available in two unique finishes.

19" Front

43300640 Gloss Black. **\$762.95**
Fits '14-later Touring models (except CVO™ models). Does not fit Trike models. Requires separate purchase of (2) Turbine Floating Brake Rotors P/N 41500120 or 41500147. '20-later models equipped with TPMS require separate purchase of Sensor P/N 32700096 (Dom and HDI) or 32700097 (Japan) and Valve Cap P/N 42300093 and Digital Tech activation.

18" Rear

40900622 Gloss Black. **\$762.95**
Fits '14-later Touring models (except CVO models). Does not fit Trike models. '20-later FL models equipped with TPMS require separate purchase of Sensor P/N 32700096 (Dom and HDI) or 32700097 (Japan) and Valve Cap P/N 42300093 and Digital Technician™ activation.

Shown with:

TURBINE FLOATING BRAKE ROTORS

Complete the custom look with floating brake rotors, styled to complement Original Equipment or custom wheels. Floating rotors feature a steel inner carrier that is shaped to accent the wheel, with a drilled stainless steel outer disc that is precision-riveted in place. Rotors are sold individually and include chrome mounting hardware.

Fits '14-'22 XL, '06-later Dyna® (except FXDLS), '15-later Softail® (except FXSE), '08-later Touring and '09-later Trike models with Original Equipment or accessory wheel with 3.25" bolt circle rotor mount.

41500120 Polished. **\$288.95**

41500147 Gloss Black Inner. **\$288.95**

D. AGITATOR CUSTOM WHEELS*

Get ready to stir things up. The 7 forward-facing spokes of these Agitator Wheels dig deep into the soul for maximum custom impact. Spiraling from the custom hub, the flat profile spokes blend to the edge of the rim, minimizing the profile of the wheel and adding an open look that's easy to see around the matching Floating Brake Rotors. Available in your choice of finish, these wheels will set the stage for your custom direction.

19" Front

Fits '09-later Road King®, Road Glide® and Street Glide® models and '14-later Ultra Classic® and Ultra Limited models (except models equipped with TPMS, '12-later CVO™ models unless originally equipped with Agitator wheels). Does not fit Trike models. Requires separate purchase of Agitator Floating Brake Rotors.

55071-11A Mirror Chrome. **\$809.95**

18" Rear

Fits '09-later Touring models (except models equipped with TPMS, '12-later CVO models unless originally equipped with Agitator wheels). Does not fit Trike models.

47951-10A Mirror Chrome. **\$809.95**

*NOTE: Requires separate purchase of model-specific Wheel Installation Kit, Sprocket hardware and Brake Rotor-specific hardware. See I-sheet for details. Installation may require separate purchase of wheel size and model-specific tire.

Model Family Fitment:

V-ROD
 SPORTSTER
 DYNA

 SOFTAIL
 TOURING

*NOTE: Requires separate purchase of model-specific Wheel Installation Kit, Sprocket hardware and Brake Rotor-specific hardware. See I-sheet for details. Installation may require separate purchase of wheel size and model-specific tire.

Notice: The prices appearing in this catalog are the manufacturer's suggested retail prices. Actual retail prices may vary.

Notice: The prices appearing in this catalog are the manufacturer's suggested retail prices. Actual retail prices may vary.

640 WHEELS

Custom Wheels

A. SEISMIC™ CUSTOM WHEELS*

This 10-spoke cast aluminum design is both aggressive in styling and attitude. Offered in Gloss Black with Machined Highlights or Matte Graphite finishes.

21" Front
Fits '18-later FXBR and FXBRS models.
43300597 Gloss Black with Machined Highlights. **\$664.95**

18" Front
Fits '18-later FLFB and FLFBS models.
43300594 Gloss Black with Machined Highlights. **\$664.95**

18" Rear
Fits '18-later FXBR, FXBRS, FLFB, and FLFBS models..
40900574 Gloss Black with Machined Highlights. **\$664.95**

B. ANNIHILATOR CUSTOM WHEELS*

As you run red light to red light, never settle for second place. The 6-spoke design of the Annihilator Custom Wheel commands attention while slamming through the twists or city streets. The fierce lines on the rim add a custom look that is sure to obliterate the competition. Tested to H-D's rigorous standards for durability and finish, the Annihilator Wheel will give you years of un-rivaled style and trouble-free miles. Requires separate purchase of model-specific Wheel Installation Kit, Sprocket Hardware and Brake Rotor-specific hardware.

19" Front
Fits '18-later FXBB, FXBBS models and '20-later FXST models.
43300593 Gloss Black with Machined Highlights. **\$664.95**

18" Front
Fits '18-later FL5B models.
43300589 Gloss Black with Machined Highlights. **\$664.95**

16" Rear
Fits '18-later FXBB, FXBBS models and '20-later FXST models.
40900571 Gloss Black with Machined Highlights. **\$664.95**

16" Rear
Fits '18-later FXFB, FXFBS, FXLR and FL5B models.
40900572 Gloss Black with Machined Highlights. **\$664.95**



A. SEISMIC CUSTOM WHEEL – GLOSS BLACK WITH MACHINED HIGHLIGHTS



B. ANNIHILATOR CUSTOM WHEEL – GLOSS BLACK WITH MACHINED HIGHLIGHTS

*NOTE: Requires separate purchase of model-specific Wheel Installation Kit, Sprocket hardware and Brake Rotor-specific hardware. See I-sheet for details. Installation may require separate purchase of wheel size and model-specific tire.

Notice: The prices appearing in this catalog are the manufacturer's suggested retail prices. Actual retail prices may vary.

WHEELS 641

Wheel Installation Kits

C. WHEEL INSTALLATION KITS

Once you select your wheel style, select the Wheel Installation Kit designed specifically for your motorcycle. Kit includes the bearings and spacers required for installation.

43848-08A Front, 1.0" axle. **\$95.95**
Fits '02-'07 VRSC™, '04-'07 Dyna® (except '04-'05 FXDWG) and '00-'07 Touring models.

42400034 Front, 25mm axle, ABS. **\$84.95**
Fits '18-later Softail® models with ABS brakes (except FLDE, FLHC, FLHCS, FL5L, FXLR5 and FXLR5T).

42400033 Front, 25mm axle. **\$84.95**
Fits '18-later Softail models without ABS (except FL5L).

43851-11B Front, 25mm axle. **\$84.95**
Fits '18-later FL5L models without ABS brakes, '08-'17 FLD, FXDF and FXDWG without ABS brakes and '07-'17 Softail models without ABS brakes (except FL5TSC, FL5TSB, FXCW, FXCWC, FXSB and FXSE).

41454-08B Front, 25mm axle, ABS. **\$84.95**
Fits '08-'17 VRSC with ABS brakes, '12-'17 FXDB, FXDC and FXDL and '16-'17 FXDLS with ABS brakes, '08-later Touring models with ABS brakes, and '19-later Trike models with ABS brakes.

41455-08C Front, 25mm axle. **\$84.95**
Fits '08-'17 VRSC without ABS brakes, '08-'17 Dyna without ABS brakes (except FLD, FXDF, FXDLS and FXDWG), '16-'17 FXSE and '08-later Touring and Trike models without ABS brakes. Also fits '09-'11 Sidecar.

42400008 Front, 25mm axle. **\$84.95**
Fits '15-'20 XG, (except XG750A), '08-'22 XL without ABS brakes and '13-'17 FXSB models without ABS brakes.

42400009A Front, 25mm axle, ABS. **\$84.95**
Fits '14-'22 XL models with ABS brakes and '13-'17 FXSB and FXSBSE models with ABS brakes.

42400010A Front, 25mm axle, ABS. **\$84.95**
Fits '18-later FL5L, FLDE, FLHC and FLHCS models with ABS brakes, '12-'17 FLD, FXDF and FXDWG with ABS brakes and '11-'17 Softail models with ABS brakes (except FL5TSB and FXCWC, FXCW, FXSB and FXSBSE).

43854-08A Rear, .75" axle. **\$95.95**
Fits '00-'04 XL, '00-'05 Dyna, '00-'07 Softail and '00-'01 Touring models.

43861-08A Rear, 1.0" axle. **\$95.95**
Fits '02-'07 VRSC, '05-'07 XL, '06-'07 Dyna and '02-'07 Touring models.

43878-08B Rear, 25mm axle. **\$84.95**
Fits '08-'19 XL (except XL1200CX), '18-later FL5L, FLDE, FLHC and FLHCS models without ABS brakes, '08-'17 Softail® (except FXCW, FXCWC, FXSB and FXSE) and '08 Touring models without ABS brakes.

41451-08C Rear, 25mm axle. **\$84.95**
Fits '15-'20 XG, '16-'21 XL1200CX, '18-'22 XL1200NS and XL1200XS and '20-'22 XL and '08-'17 Dyna® models without ABS brakes.

41456-08C Rear, 25mm axle. **\$84.95**
Fits '08-'13 VRSC™ without ABS brakes, '08-'13 FXCW, FXCWC and FXSB without ABS brakes and '09-'19 Touring models without ABS brakes.

41453-08C Rear, 25mm axle, ABS. **\$84.95**
Fits '08-'17 VRSC with ABS brakes, '14-'22 XL with ABS brakes (except '16-'19 XL1200CX) and '08-later Touring models with ABS brakes.

42400036 Rear, 25mm, ABS **\$84.95**
Fits '18-later Softail models with ABS.

42400035 Rear 25mm **\$84.95**
Fits '18-later Softail models without ABS.

43077-11A Rear, 25mm axle, ABS. **\$84.95**
Fits '18-later FL5L, FLDE, FLHC and FLHCS models with ABS brakes, '11-'17 Softail models with ABS brakes.

42400003 Rear, 25mm axle, ABS. **\$84.95**
Fits '12-'17 Dyna models with ABS brakes.

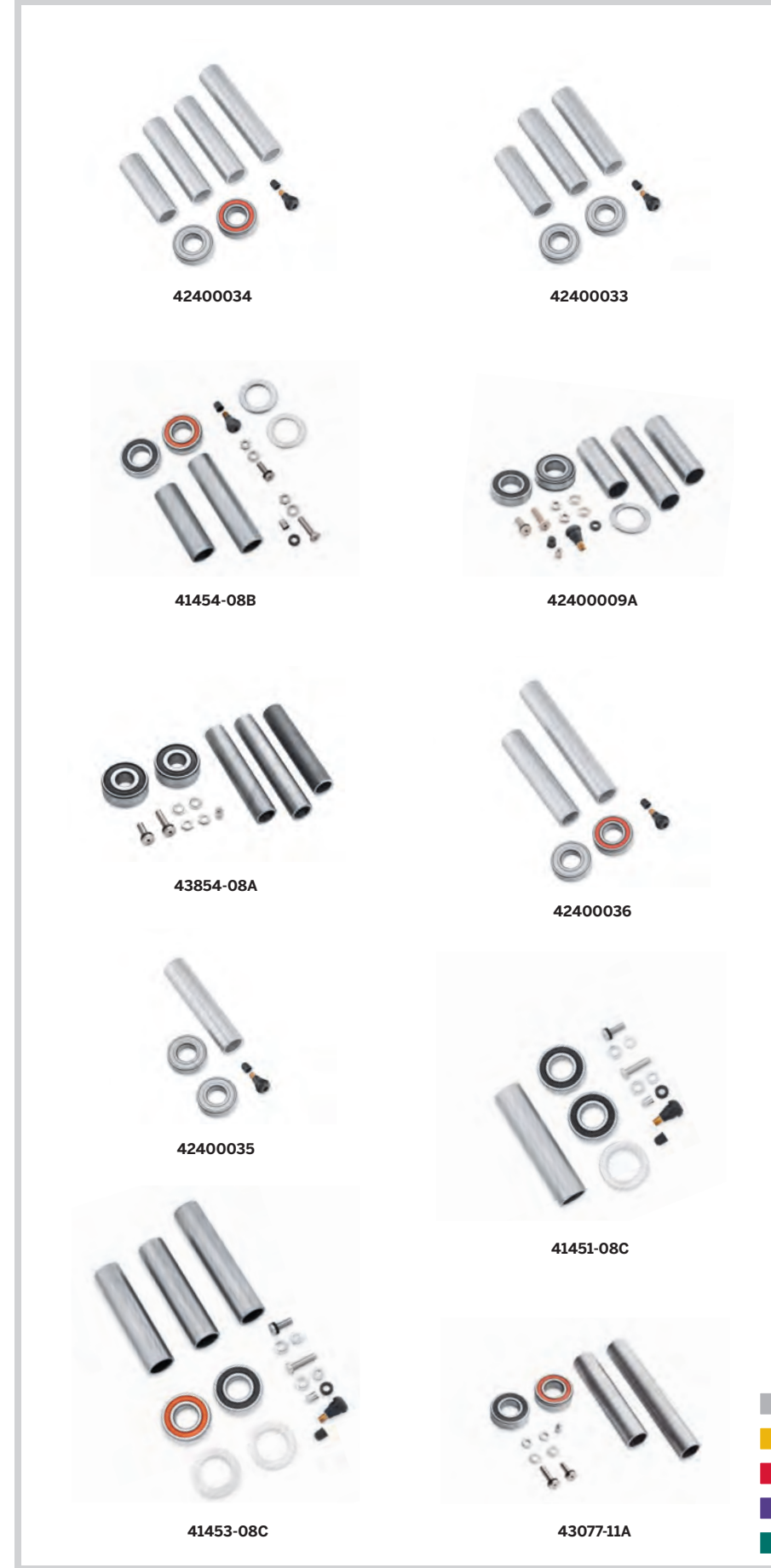

C. WHEEL INSTALLATION KITS

Model Family Fitment:
 V-ROD
 SPORTSTER
 DYNA
 SOFTAIL
 TOURING

Notice: The prices appearing in this catalog are the manufacturer's suggested retail prices. Actual retail prices may vary.

642 WHEELS

Brake Rotors

POLISHED BRAKE ROTORS

A perfect complement to stock or custom wheels. Manufactured to Original Equipment specifications for exact fit, these rotors are meticulously polished to achieve a chrome-like appearance. Rotors are sold individually and include chrome installation hardware.

A. Fits '09-later Touring models (except FLHRC, FLHRSE and FLHTKSE) with H-D Prodigy, Tomahawk, Enforcer or Impeller wheels.

41500094 Front. **\$221.95**

B. Fits '00-'13 XL and XR, '00-'05 Dyna®, '00-'14 Softail® (except Springer™) and '00-'07 Touring models.

41830-05A Front – Left Side. **\$168.95**

41831-05A Front – Right Side. **\$168.95**

C. Fits '17-'20 FLHRXS, '14-later FLHRC and '08-'13 Touring (except '08 FLHRSE, '10-'11 FLHXSE and '09 FLTRSE) and Trike models. Fits selected accessories wheels with standard 5-hole hub-mount brake disc. Consult wheel I-sheet for details.

44950-08 Front – Left Side. **\$168.95**

44959-08 Front – Right Side. **\$168.95**

D. Fits '06-'17 VRSC™ and Dyna models. Also fits '08-later Touring and Trike models. Requires Original Equipment or accessory wheel with 6.7" bolt circle rotor mount. Does not fit Enforcer or Impeller wheels.

41500012A Front. **\$168.95**

E. Fits '00-'10 XL, '00-'17 Dyna and Softail and '00-'07 Touring models. Separate purchase of Brake Rotor Hub Plate P/N 43837-00 is required when installing on FXSTD Original Equipment 17" wheels.

41832-05A Rear. **\$168.95**

F. AGITATOR POLISHED BRAKE ROTORS

Front Left. Fits '09-later Touring models equipped with Agitator Custom Front Wheel (except CVO™ models).

41500007 Chrome Inner. **\$237.95**

41500053 Gloss Black Inner. **\$237.95**

Front Right. Fits '09-later Touring models equipped with Agitator Custom Front Wheel (except CVO models).

41500008 Chrome Inner. **\$237.95**

41500052 Gloss Black Inner. **\$237.95**



A. POLISHED BRAKE ROTOR – FRONT



A. POLISHED BRAKE ROTOR – FRONT



G. SEISMIC BRAKE ROTORS – GRAPHITE



H. ANNIHILATOR BRAKE ROTORS – GLOSS BLACK



B. POLISHED BRAKE ROTOR – FRONT (41831-05A SHOWN)



C. POLISHED BRAKE ROTOR – FRONT (44950-08 SHOWN)



I. POLISHED FLOATING BRAKE ROTORS – SPLIT 7 SPOKE



I. POLISHED FLOATING BRAKE ROTORS – SPLIT 7 SPOKE, BLACK

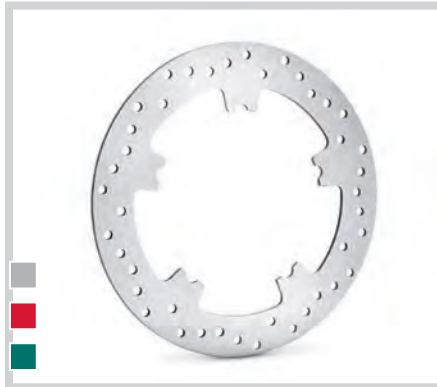

D. POLISHED BRAKE ROTOR – FRONT



E. POLISHED BRAKE ROTOR – REAR



I. POLISHED FLOATING BRAKE ROTORS – CHROME



I. POLISHED FLOATING BRAKE ROTORS – TEARDROP



F. POLISHED AGITATOR POLISHED BRAKE ROTORS – CHROME INNER



F. POLISHED AGITATOR POLISHED BRAKE ROTORS – GLOSS BLACK INNER



I. POLISHED FLOATING BRAKE ROTORS – VIVID BLACK



I. POLISHED FLOATING BRAKE ROTORS – TURBINE (INSET SHOWS GLOSS BLACK)

Model Family Fitment:

- V-ROD
- SPORTSTER
- DYNA
- SOFTAIL
- TOURING

Notice: The prices appearing in this catalog are the manufacturer's suggested retail prices. Actual retail prices may vary.

WHEELS 643

Brake Rotors

G. SEISMIC™ BRAKE ROTOR

A perfect complement to the 10 spoke Seismic™ Custom Wheel or replacement of OE rotor. Offered with a Gloss Black Inner or Matte Graphite Inner. Installation hardware included.

Front
Fits '14-'22 XL, '06-'17 Dyna® (except FXDLS), '15-later Softail® (except FXSE), '08-later Touring and '09-later Trike models with Original equipment or accessory wheel with 3.25" bolt circle rotor mount.

41500154 Gloss Black Inner. **\$213.95**

41500163 Matte Graphite Inner. **\$221.95**

Rear
Fits '00-'10 XL, '00-'17 Dyna® (except FXDLS), '00-later Softail (except FXSE), '00-'07 Touring models. Separate purchase of Brake Rotor Hub Plate P/N 43837-00 is required when installing on FXSTD Original Equipment 17" wheels.

41500156 Gloss Black Inner. **\$213.95**

41500161 Matte Graphite Inner. **\$221.95**

H. ANNIHILATOR BRAKE ROTORS

Add a custom of one look to your 6-spoke Annihilator Custom Wheel with the floating Annihilator Brake Rotor. This brake rotor features a steel inner carrier that is shaped to accent the Annihilator wheel and features a drilled stainless steel outer disc that is precision-riveted in place. Rotors are sold individually and include chrome installation hardware.

Front
Fits '14-'22 XL, '06-'17 Dyna® (except FXDLS), '15-later Softail® (except FXSE), '08-later Touring and '09-later Trike models with Original equipment or accessory wheel with 3.25" bolt circle rotor mount.

41500172 Gloss Black Inner. **\$221.95**

Rear
Fits '00-'10 XL, '00-'17 Dyna (except FXDLS), '00-later Softail (except FXSE) and '00-'07 Touring models. Separate purchase of Brake Rotor Hub Plate P/N 43837-00 is required when installing on FXSTD Original Equipment 17" wheels.

41500174 Gloss Black Inner. **\$221.95**

I. POLISHED FLOATING BRAKE ROTORS

Complete the custom look with floating brake rotors, styled to complement Original Equipment or custom wheels. Floating rotors feature a steel inner carrier that is shaped to accent the wheel, with a polished and drilled stainless steel outer disc that is precision-riveted in place. Rotors are sold individually and include chrome installation hardware.

Front
Fits '14-'22 XL, '06-'17 Dyna® (except FXDLS), '15-later Softail® (except FXSE), '08-later Touring and '09-later Trike models with Original Equipment or accessory wheel with 3.25" bolt circle rotor mount.

41500107 Split 7 Spoke. **\$221.95**

41500108 Split 7 Spoke, Black. **\$209.95**

44944-08A Chrome. **\$173.95**

44942-08A Teardrop – Chrome & Raw. **\$173.95**

44947-08A Vivid Black. **\$173.95**

41500120 Turbine. **\$288.95**

41500147 Turbine – Gloss Black. **\$288.95**

Front
Fits '00-'13 XL and XR, '00-'05 Dyna, '00-'14 Softail (except Springer™) and '00-'07 Touring models.

44360-00A Chrome. **\$173.95**

44367-00A Teardrop. **\$173.95**

44358-00A Vivid Black. **\$173.95**

Rear
Fits '00-'10 XL, '00-'17 Dyna (except FXDLS), '00-later Softail (except FXSE), and '00-'07 Touring models. Separate purchase of Brake Rotor Hub Plate P/N 43837-00 is required when installing on FXSTD original equipment 17" wheels.

41500109 Split 7 Spoke. **\$221.95**

41500110 Split 7 Spoke, Black. **\$209.95**

44359-00A Chrome. **\$173.95**

44368-00A Teardrop. **\$173.95**

44357-00A Vivid Black. **\$173.95**

41500069 Turbine. **\$314.95**

Notice: The prices appearing in this catalog are the manufacturer's suggested retail prices. Actual retail prices may vary.

644 WHEELS

Billet Sprockets & Accessories

A. TURBINE BILLET SPROCKET

Designed to complement the wheel's styling, these custom sprockets are manufactured from 6061-T6 forged billet aircraft aluminum and precision machined to exacting Original Equipment standards. Harley-Davidson® custom sprockets are finished with a proprietary process that combines the decorative chrome with a wear-resistant surface applied to the teeth.

42200007 **\$487.95**
Fits '18-later Softail® models, '07-'17 FLS, FLSS, FLSTC, FLSTN, FLSTSC, FXCW, FXCWC, FXS, FXSB and FXSTD, '12-'17 FLSTF, FLSTFB, FLSTFBS, FLSTNSE, FLSTSE, FXSBSE and FXST, and '16-'17 FXSE models. Does not fit '07-'15 Japan models. Requires separate purchase of model-specific sprocket mounting hardware.

B. MAGNUM 5 SPROCKET COVER - CHROME

Styled to match the distinctive Magnum 5 Custom Wheel. Available in mirror chrome, this Sprocket Cover gives the appearance of having a custom sprocket at a fraction of the cost. Cover is easy to install with Original Equipment hardware or add the Chrome Hardware Kit P/N 94773-07 (sold separately) for a finished look.

40120-09 **\$69.95**
Fits '07-'17 Dyna® models (except FLD).

C. CHROME SPROCKET COVER

This Sprocket Cover gives the appearance of having a chrome sprocket at a fraction of the cost. It matches the styling of the Original Equipment sprocket and bolts on using the stock hardware.

37757-07 **\$64.95**
Fits '07-'17 Softail (except FLSTNSE, FXCW, FXCWC, FXSB, FXSBSE and FXSE).

91347-00 **\$64.95**
Fits '00-'06 Softail models.

D. REAR SPROCKET BOLT COVER KIT

These chrome-plated covers with internal spring clips hide the Original Equipment sprocket bolts for a clean, custom look. Set of 5 covers.

43876-04 **\$46.95**
Fits '04-'22 XL, '93-'17 Softail, '99-later Touring models with Original Equipment 7/16" hex head sprocket mounting bolts (5/8" hex across the flats).



A. TURBINE BILLET SPROCKET



B. MAGNUM 5 SPROCKET COVER - CHROME



C. SPROCKET COVER - CHROME



D. REAR SPROCKET BOLT COVER KIT



E. DECORATIVE WHEEL WEIGHTS - BAR & SHIELD



F. BRAKE ROTOR HARDWARE KIT - CHROME (91800029 SHOWN)



F. BRAKE ROTOR HARDWARE KIT - CHROME (41500095 SHOWN)



F. BRAKE ROTOR HARDWARE KIT - CHROME (46646-05 SHOWN)



G. SPROCKET HARDWARE - CHROME HEX HEAD



H. CHROME-PLATED ABS VALVE STEM CAPS



I. CHROME-PLATED BRASS VALVE STEM CAPS

WHEELS 645

Wheel Accessories

E. DECORATIVE WHEEL WEIGHTS - BAR & SHIELD

Calibrate your wheel balance with a touch of class with these uniquely designed wheel weights. Adhesive backing for easy installation.

95615-04 .5 oz. **\$3.95**
Fits Original Equipment and accessory wheel rims.

F. BRAKE ROTOR HARDWARE KIT - CHROME

It's the details, like this chrome hardware kit, that really get your bike noticed. This hardware adds a unique chrome-plated finish to the Original Equipment or accessory floating brake rotors. Kit includes 5 chrome-plated bolts manufactured to factory specifications to ensure fit and performance.

91800029 Shoulder Bolt - Front. **\$40.95**
Fits '02-later models equipped with Open Brake Rotor P/N 44343-01, 44553-06A, 41500012A, 41500040 or 41500042.

41500095 Button Head - Front. **\$47.95**
Fits '09-later Touring models equipped with Enforcer or Impeller Wheels.

46646-05 Button Head - Front. **\$19.95**
Fits '90-later models (except VRSC™, FXSB, FXSE, '14-later Touring and Trike and models equipped with Open Brake Rotor P/N 44343-01, 44553-06A, 41500012, 41500040 or 41500042). Does not fit RA1250 and RA1250S models.

46647-05 Button Head - Rear. **\$19.95**
Fits '92-later models (except Trike). Does not fit RA1250 and RA1250S.

G. SPROCKET HARDWARE - CHROME HEX HEAD

This kit includes highly polished, chrome-plated, grade 8 hex-head screws with chrome-plated washers, providing an extra custom accent. The perfect addition to the chrome sprocket. Made from the same Original Equipment bolts to ensure product integrity. Also works with chrome belt sprocket covers and Original Equipment sprockets.

94773-07 **\$36.95**
Fits '07-'17 Dyna® and Softail® models.

94773-00A **\$36.95**
Fits '00-'05 Dyna and '00-'06 Softail models.

94708-98 **\$36.95**
Fits '91-'22 XL and '93-'99 Dyna and Softail models.

H. CHROME-PLATED ABS VALVE STEM CAPS

A special chrome touch with special graphics. Will not seize on valve stems and includes O-rings for reliable seal. Sold in pairs.

Universal fitment. Also fits suspension air valves.

1. 41144-97 Color Bar & Shield Logo. **\$11.95**

2. 41145-97 Bar & Shield Outline on Black. **\$11.95**

3. 41171-03 White Skull Logo on Black. **\$11.95**

I. CHROME-PLATED BRASS VALVE STEM CAPS

The beauty of chrome with the durability of machined brass, featuring a laser-etched Bar & Shield logo painted black. Available with a traditional, unique fluted or rugged acorn-shaped cylinder. Will not seize on valve stems and includes O-rings for reliable seal. Sold in pairs.

Universal fitment. Also fits suspension air valves.

1. 41148-98 **\$18.95**

Acorn Nut with Bar & Shield Logo.

2. 41150-98 **\$18.95**

Acorn Nut with Grooved Cylinder with Bar & Shield Logo.

Model Family Fitment:

V-ROD
 SPORTSTER
 DYNA
 SOFTAIL
 TOURING

Notice: The prices appearing in this catalog are the manufacturer's suggested retail prices. Actual retail prices may vary.

Notice: The prices appearing in this catalog are the manufacturer's suggested retail prices. Actual retail prices may vary.



Softail® Standard - Overwatch Dry Backpack

HARLEY-DAVIDSON®

LUGGAGE

Sometimes a little added storage capacity is just what you need to make your ride more enjoyable. Rain gear, extra clothing and basic supplies are easy to take along when you add luggage to your bike.

ONYX™ PREMIUM LUGGAGE COLLECTION

Designed by riders for riders, the Onyx™ Premium Luggage Collection is constructed from heavy-weight, UV-stable ballistic nylon that will protect your belongings from the elements while maintaining their shape and color so they look as good off the bike as on.

UV-RESISTANT FINISH

Solution-dyed during fabric production for long-life UV-resistance even when exposed to the sun's harshest rays.

REFLECTIVE TRIM

Reflective trim adds an extra touch of visibility to other motorists.

DURABLE BALLISTIC NYLON

1680 denier ballistic polyester material maintains its sturdy shape and protects your belongings for the long haul.

SECURE MOLLE MOUNTING SYSTEM

The versatile MOLLE (Modular Lightweight Load-Carrying Equipment) mounting system allows for modular pouch attachment. Slip-resistant bottom keeps the bag in place on your bike.

**2-YEAR
HARLEY-DAVIDSON™
WARRANTY**

LOCKING QUICK-RELEASE MOUNTING STRAPS

Convenient straps simplify installation and removal and provide a secure no-shift fit.



ORANGE INTERIOR

Orange interior fabric makes it easy to see bag contents in almost any light.



OVERSIZE HANDLES

Soft-touch ergonomic handle is shaped for effortless transport to and from the bike.



GLOVE-FRIENDLY ZIPPER PULLS

Ergonomically contoured rubberized zipper pulls are large and glove-friendly for on-the-go bag access.



INTEGRATED RAIN COVER

Features elastic bungee cord with a barrel lock tensioner to keep cover securely fastened over the luggage. Cover features a reflective Bar & Shield logo for enhanced visibility.



Touring Bags

ONYX™ PREMIUM LUGGAGE COLLECTION

Designed by riders for riders, the Onyx™ Premium Luggage Collection provides everything you need in motorcycle luggage and nothing you don't. Made of premium 1680 denier, UV-stable ballistic polyester material, these bags will stand up to the toughest road and weather conditions and won't fade through years of use. All bags in the collection feature water-resistant zippers with rubber Harley-Davidson® branded, glove-friendly zipper pulls for easy open and close, a burnt orange interior that allows you to see the bag's contents in almost any light, a plethora of internal and external pockets to make organization easy, MOLLE-style webbing for easy modular pouch attachment and reflective piping to provide visibility to other motorists. Abrasion-resistant non-slip material on the bottom of each bag ensures your bag stays put, and each bag includes a rain cover featuring an elastic hem and barrel lock mechanism so the cover can be cinched tight ensuring it stays in place at highway speeds. All Onyx Collection Premium Luggage features a limited two-year warranty. See Dealer for details.



A. ONYX PREMIUM LUGGAGE COLLECTION TOURING BAG

A. ONYX PREMIUM LUGGAGE COLLECTION TOURING BAG

The Onyx Collection Touring Bag is perfect for long-haul trips. This bag features a separate top compartment to keep your shoes separate from your clothes, a main compartment that can store enough jeans and T-shirts for a two-week trip and the main compartment lid features removable lid straps that keep the top compartment from falling forward or back when loading the main compartment. The large front pocket holds keys, pens, documents and small electronics. The two outer pockets at the top of the bag are perfect for eyewear storage, while the two large lower exterior pockets are perfect for storing rain gear. Dimensions: 19.2" W x 12.7" D x 20.5" T Capacity: 3,500 cubic inches

93300103 \$305.95
Installation requires a sissy bar upright and backrest pad. Luggage rack required if not mounting on passenger pillion. Does not fit XR1200, XR1200X, FXDRS, and XG models.



B. ONYX PREMIUM LUGGAGE COLLECTION WEEKENDER BAG

B. ONYX PREMIUM LUGGAGE COLLECTION WEEKENDER BAG

The Onyx Collection Weekender Bag is ideal for around town use or a weekend getaway. This backpack-style bag has a cavernous main compartment that is large enough for a pair of boots or shoes, a change of clothes, an extra jacket or sweatshirt and extra gloves and hats. It also features a padded laptop compartment and two additional padded pockets for small electronics. The bag also features two outer top pockets, one that is felt lined for eyewear storage, a draw-bridge style front compartment for storing pens and documents and four additional side pockets that are great for storing phone chargers, keys and other small items. The bag's rigid structure ensures its shape is maintained, even when the bag is empty, and the attached mounting straps conveniently tuck away into a built-in storage pouch for a clean look. This bag also features padded backpack straps and raised back padding to make carrying the bag to and from your bike a comfortable proposition. Dimensions: 18" W x 11.5" D x 18" T Capacity: 1,800 cubic inches

93300105 \$263.95
Installation requires a sissy bar upright and backrest pad. Luggage rack required if not mounting on passenger pillion. Does not fit XR1200, XR1200X, FXDRS, and XG models.



C. ONYX PREMIUM LUGGAGE COLLECTION DAY BAG

C. ONYX PREMIUM LUGGAGE COLLECTION DAY BAG

This compact Day Bag is perfect for your daily work commute or a short day trip. The main compartment is great for storing a sweatshirt, a pair of shoes, a rain suit, gloves or caps. Interior mesh zip pocket holds keys or small electronics. The rigid structure of the bag ensures it keeps its shape, even when empty and the detachable, padded shoulder strap makes the bag easy to carry. Dimensions: 16.75" W x 9" D x 9" T. Capacity: 1,000 cubic inches

93300104 \$143.95
Fits models equipped with Luggage Racks, with or without a Sissy Bar Upright, and Tour-Pak Luggage Racks (except Mini Rack P/N 53100-95). Does not fit XG750A models. Installation requires a sissy bar upright and backrest pad. Luggage rack required if not mounting on passenger pillion.

Model Family Fitment:

- V-ROD
- SPORTSTER
- DYNA
- SOFTAIL
- TOURING

Notice: The prices appearing in this catalog are the manufacturer's suggested retail prices. Actual retail prices may vary.

650 LUGGAGE

Onyx™ Premium Luggage Collection

A. ONYX™ PREMIUM LUGGAGE COLLECTION TOUR-PAK® RACK BAG

The Tour-Pak® Rack Bag is designed to fit atop most Tour-Pak Luggage Racks, this bag provides the additional storage you need for long trips. The main compartment features three mesh pockets for easy organization while also providing enough space to stow clothes for a short trip. Outside the bag, the top zip pocket is fleece lined for protective eyewear storage while the front, back and side pockets are great for storing gloves and organizing keys, cords and your phone charger. Dual side-carry handles, a stowable rubber top carry handle and a detachable shoulder strap make off bike transport easy. Rigid construction insures the bag keeps its shape, even when empty. Dimensions: 24" W x 14" D x 10.4" T. Capacity: 2,600 cubic inches

93300123 **\$263.95**
Fits models equipped with Tour-Pak Luggage Racks (except FLRT and FLHXXX or Mini Rack P/N 53100-96).



A. ONYX PREMIUM LUGGAGE COLLECTION TOUR-PAK RACK BAG



B. ONYX PREMIUM LUGGAGE COLLECTION COLLAPSIBLE TOUR-PAK RACK BAG



C. ONYX PREMIUM LUGGAGE COLLECTION TAIL BAG



D. ONYX PREMIUM LUGGAGE COLLECTION RIDER BACKREST BAG



E. ONYX PREMIUM LUGGAGE COLLECTION TANK BAG



F. ONYX PREMIUM LUGGAGE COLLECTION BACKSEAT ROLLER BAG



F. ONYX PREMIUM LUGGAGE COLLECTION BACKSEAT ROLLER BAG

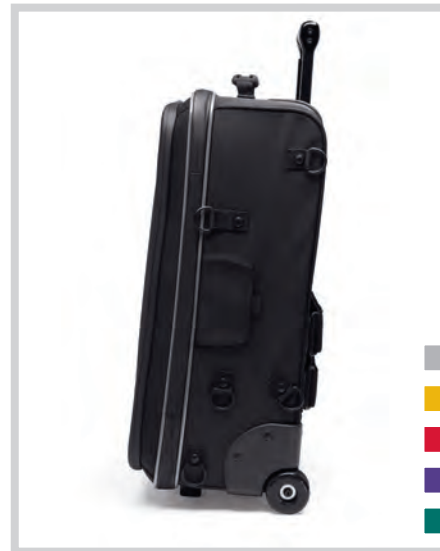

G. ONYX PREMIUM LUGGAGE COLLECTION FLY AND RIDE BAG



F. ONYX PREMIUM LUGGAGE COLLECTION BACKSEAT ROLLER BAG

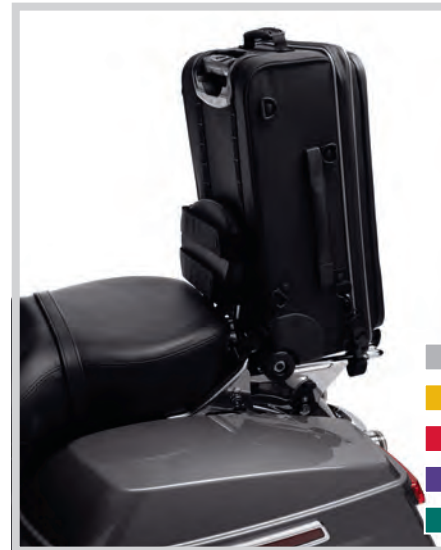

G. ONYX PREMIUM LUGGAGE COLLECTION FLY AND RIDE BAG



G. ONYX PREMIUM LUGGAGE COLLECTION FLY AND RIDE BAG

LUGGAGE 651

Onyx Premium Luggage Collection

F. ONYX™ PREMIUM LUGGAGE COLLECTION BACKSEAT ROLLER BAG

This Backseat Roller Bag has everything a solo rider needs to rule the road. Unmatched durability, effortless transport and immense storage space. With its locking push-button handle that extends to 20.5" and smooth-rolling skateboard wheels, moving gear from bike to bunk has never been easier. The massive main compartment can carry weeks of clothes for your grand tour and features a large elastic pouch and zippered mesh pocket to organize the rest of your riding essentials. Two outer stash pockets store sunglasses, rain gear and electronics with ease, and the external bungee keeps coats and bedrolls secured. Compatible with the Onyx™ Premium Luggage Collection Rider Backrest Pad for long-haul comfort and support. Dimensions: 16" W x 13" D x 18" T. Capacity: 3,200 cubic inches

93300126 **\$316.95**
Fits '14-later Touring and Tri Glide® models equipped with a King Tour-Pak® Carrier. Tour-Pak luggage carrier must be equipped with luggage rack on top for proper installation.

G. ONYX PREMIUM LUGGAGE COLLECTION FLY AND RIDE BAG

Designed by riders for riders, the Onyx™ Premium Luggage Collection is the best luggage Harley-Davidson has to offer and provides everything you need in motorcycle luggage and nothing you don't. The Fly and Ride Bag will breeze through airport security and is designed to be an ideal carry-on bag for the rider flying to meet their bike, or taking off on any adventure.

Locking-push button handle that extends by 16" to a height of 38.25" and smooth-rolling skateboard wheels make this bag easy to handle in the airport. Designed to fit in most commercial aircraft overhead bins for easy travel. Fold-out TSA-approved padded sleeve accommodates 15" laptop plus a separate tablet sleeve. Rollers designed not to scuff seat when mounted to sissy bar. Water-resistant zippers with rubber Harley-Davidson branded, glove-friendly pulls for easy open and close. High-contrast orange interior makes it easy to see bag contents in almost any light and a plethora of internal and external pockets and an adjustable shelf make organization easy. MOLLE-style webbing for easy modular pouch attachment. Abrasion-resistant, non-slip bottom keeps the bag in place. Dimensions: (approximate): 14" W x 9" D x 22" H. Capacity (approximate): 2450 CI

93300158 **\$302.95**
Installation requires a sissy bar upright and backrest pad. Luggage rack required if not mounting on passenger pillion. Does not fit XR1200, XR1200X, FXDRS, and XG models.

Model Family Fitment:

- V-ROD
- SPORTSTER
- DYNA
- SOFTAIL
- TOURING

Notice: The prices appearing in this catalog are the manufacturer's suggested retail prices. Actual retail prices may vary.

Notice: The prices appearing in this catalog are the manufacturer's suggested retail prices. Actual retail prices may vary.

652 LUGGAGE

Overwatch Luggage

A. OVERWATCH DRY BACKPACK

Designed specifically for motorcycle travel, the versatile and rugged Overwatch Dry Backpack will protect your gear in the harshest conditions, on and off the motorcycle. Roll-top closure and waterproof liner protect main compartment. Water-resistant 1280 denier PVC-backed nylon shell and water-resistant zippers make for the ultimate in weather protection. Features mounting straps that can be quickly reconfigured and used as backpack straps. A chest strap, breathable back pad, and removable waist straps allow for a full conversion to a comfortable backpack. Includes 4 removable mounting straps and multiple mounting loops for easy and secure mounting to sissy bar or luggage rack. 3 outer pockets and an internal 15 inch laptop sleeve add versatility. High-contrast orange waterproof liner in main compartment makes it easy to view contents. 32L capacity.

93300168 **\$299.95**

Installation requires a sissy bar upright and backrest pad. Luggage rack required if not mounting on passenger pillion. Does not fit XG luggage racks. Does not fit with '18-later short Softail® passenger uprights.

B. OVERWATCH DRY BAG

Keep your gear dry with the Overwatch Dry Bag. This water-resistant bag has a large main compartment that features a roll top design with easy-to-use quick-release buckle closures and abrasion-resistant non-slip material on the bottom. Two outer zip pockets are great for storing smaller items. MOLLE-style attachment system on the bag's top make it easy to attach small pouches to this bag and the convenient centered handle make for easy transport to and from your bike. Dimensions: 11.5" D x 19" T. Luggage capacity: 2,000 cubic inches.

93300119 **\$164.95**

Installation requires a sissy bar upright and backrest pad. Luggage rack required if not mounting on passenger pillion. Does not fit XG luggage racks. Does not fit with '18-later short Softail® passenger uprights.

C. OVERWATCH LARGE SISSY BAR BAG

This Sissy Bar Bag features a cavernous main compartment large enough to accommodate enough clothes for a long weekend trip and a hook and loop closure that rolls and clips to keep water out. Sunglasses and other small items fit conveniently in the small front pocket while the draw-bridge style outer pocket features two removeable tool pouches (tools not included) which can also be used to organize cords and keys. An elasticized side pouch fits a large water bottle. Back and side handles make for easy transport once the bag is detached from the bike. Dimensions: 14" W x 7" D x 20" T. Luggage capacity: 2,000 cubic inches.

93300120 **\$252.95**

Installation requires a sissy bar upright and backrest pad. Luggage rack required if not mounting on passenger pillion. Does not fit XG luggage racks. Does not fit with '18-later short Softail passenger uprights.

D. OVERWATCH LARGE HANDLEBAR BAG

The roomy Overwatch Large Handlebar Bag is the ultimate in style and practicality. This bag features a removable top compartment with a clear plastic touchscreen pouch that is perfect for holding your phone or GPS. The top pouch also has a zippered compartment that is perfect for storing your wallet and keys. The larger main compartment features one zip and one mesh pocket for organization. Adjustable quick-release buckles and MOLLE-style mounting system with hook and loop straps make for easy attachment. Six multi-fit hook-and-loop mounting straps are included. Dimensions: 4.5" W x 9.5" D x 7" T. Luggage capacity: 250 cubic inches.

93300122 **\$143.95**

Fits Original Equipment and Accessory risers that are 2" or taller. Does not fit XL models if equipped with triple clamp-integrated risers and 4" diameter riser-mounted speedometers. Does not fit with windshields.

E. OVERWATCH SMALL HANDLEBAR BAG

The Overwatch Small Handlebar Bag is perfect for packing essential items. This bag features one main interior pocket that is the perfect place to put your phone, wallet and keys while riding your motorcycle. MOLLE-style web system with hook and loop straps allow for versatile bag attachment. Six hook-and-loop mounting straps are included. Dimensions: 6" W x 8" D x 2.5" T. Luggage capacity: 100 cubic inches.

93300121 **\$98.95**

Fits Original Equipment and Accessory risers that are 2" or taller. Does not fit XL models if equipped with triple clamp-integrated risers and 4" diameter riser-mounted speedometers. Fits with some windshields.



A. OVERWATCH DRY BACKPACK



B. OVERWATCH DRY BAG



C. OVERWATCH SISSY BAR BAG



D. OVERWATCH LARGE HANDLEBAR BAG



E. OVERWATCH SMALL HANDLEBAR BAG



F. WAXED CANVAS BACK PACK



G. WAXED CANVAS MESSENGER BAG



H. HDMC MESSENGER BAG – BLACK/SILVER



I. PREMIUM TRAVEL-PAK – KING TOUR-PAK



I. PREMIUM TRAVEL-PAK – SADDLEBAGS



J. TRAVEL-PAKS – SADDLEBAGS (93300107 SHOWN)



J. TRAVEL-PAK – KING TOUR-PAK (53605-97 SHOWN)



J. TRAVEL-PAK – HARD SADDLEBAGS (91885-97A SHOWN)

LUGGAGE 653

Travel-Paks

F. WAXED CANVAS BACKPACK

The thick, solution-dyed, waxed canvas construction and the heavy-gauge leather on the bottom give it a unique look and character. It features an interior padded laptop sleeve, to securely stow your laptop computer (up to 15"). The roll-top design has simple, easy-to-use buckles for secure closure. A water-resistant, high-contrast orange liner makes it easy to find things inside, while the wide, comfortable backpack straps (with sternum strap) provide all-day comfort.

93300117 **\$207.95**

Installation on bike requires a sissy bar upright and backrest pad or luggage rack.

G. WAXED CANVAS MESSENGER BAG

The thick, solution-dyed, waxed canvas construction and the heavy-gauge leather on the bottom give it a unique look and character. It features an interior padded laptop sleeve, to securely stow your laptop computer (up to 15"). The roll-top design has simple, easy-to-use buckles for secure closure. A water-resistant, high-contrast orange liner makes it easy to find things inside, while the comfortable, messenger-style shoulder strap and stabilizer strap provide long-lasting comfort and style.

93300116 **\$175.95**

Installation on bike requires a sissy bar upright and backrest pad or luggage rack.

H. HDMC™ MESSENGER BAG

The soft and flexible sling bag features a padded shoulder strap with a cross-chest stabilizer strap that securely holds the bag in place across your back. Or you can secure the bag to the sissy bar with the wide adjustable hook-and-loop flap and quick release tabs. The exterior of the bag features a newspaper pocket, a side pocket and bold stenciled HDMC™ graphics. Behind the wide flap, the water-resistant inner cavity features a 10" x 15" padded laptop compartment, a padded tablet pocket and separate pockets to store cell phones, pens, glasses and more. Dimensions: 19.0" W x 3.5" D x 13.5" T.

93300099 Black/Silver. **\$196.95**

Installation requires a sissy bar upright, backrest pad and luggage rack (if not mounting on passenger pillion).

I. PREMIUM TRAVEL-PAKS

This collection of fitted luggage provides convenient storage for your next long ride. The bags are manufactured of water-resistant ballistic nylon that matches the premium luggage collection. The exterior features comfortable carrying handles, heavy-duty glove-friendly zippers, a zippered pocket and D-rings for optional carrying straps. The padded interior features a variety of convenient storage pockets and plenty of open storage. Saddlebag right-hand bag features an internal padded laptop pocket and plenty of smart storage spaces.

93300072 King Tour-Pak® Carrier. **\$110.95**

Fits '93-later Touring and Trike models equipped with King Tour-Pak luggage.

93300070 Hard Saddlebags. **\$143.95**

Fits '93-later Touring models equipped with hard saddlebags. Sold in pairs.

J. SADDLEBAG TRAVEL-PAKS

The Travel-Pak bags feature two-way zippers for easy access, and embossed Bar & Shield patches for style.

93300107 Saddlebags. **\$66.95**

Fits '18-later FLHC and FLHCS models with Original Equipment saddlebags. Also fits FLDE models equipped with Softail® Deluxe Rigid Mount Saddl ebags P/N 90201558.

93300110 Saddlebags. **\$71.95**

Fits '18-'21 FLSB and '22-later FXLRST models.

53605-97 King Tour-Pak. **\$71.95**

Fits '93-later Touring and Trike models equipped with King and Ultra Tour-Pak luggage.

91885-97A Hard Saddlebags. **\$76.95**

Fits '93-later Touring models equipped with Color-Matched Hard Saddlebags and '09-'17 VRSCF models equipped with Rigid Saddlebags P/N 91172-09. Sold in pairs.

91887-98 Leather Saddlebags. (not shown) **\$71.95**

Fits '98-'19 FLHRC and FLHRS models. Sold in pairs.

Model Family Fitment:

- V-ROD
- SPORTSTER
- DYNA
- SOFTAIL
- TOURING

Notice: The prices appearing in this catalog are the manufacturer's suggested retail prices. Actual retail prices may vary.

Notice: The prices appearing in this catalog are the manufacturer's suggested retail prices. Actual retail prices may vary.

654 LUGGAGE

Small Bags

BLACK STANDARD LINE BAGS

Made of ultra-durable leather-like synthetic featuring a debossed H-D #1 logo, the Black Standard Line Sissy Bar and Tool Bags have a simple, black on black style that complements many styling directions and budgets. An internal reinforcement system maintains the bag's shape over time. The "MOLLE-style" system of mounting loops accommodate hook and loop straps and allow for multiple mounting locations and orientations. The bags feature either matte black enamel buckles with hidden quick-detach buckles underneath or a hook and loop flap closure.

A. BLACK STANDARD LINE HANDLEBAR BAG

Made of ultra-durable leather-like synthetic, this Handlebar Bag is great for holding eyeglasses, toll passes and other small items you need within an arm's reach. Straight and 90 degree mounting loops make for versatile mounting to your bike. Internal capacity: 125Cl. Carrying capacity: 2.5 lbs.

93300112 **\$76.95**

Fits risers/handlebars without riser-mounted gauges. Does not fit 100th Anniversary logo windshields or Road Tech™ Riser Mount Radio.

B. BLACK STANDARD LINE SISSY BAR/SOLO BAG

This Sissy Bar Bag features quick-release buckles to get you in and out of the bag fast. Great for storing a light jacket, sunscreen, gloves and glasses. Bag measures 8" x 10.5" x 3.25". Internal capacity: 260Cl. Carrying capacity: 5 lbs.

93300114 **\$110.95**

C. BLACK STANDARD LINE TOOL BAG

This Tool Bag features decorative, black enamel buckles under which are quick-release buckles for easy access and can be mounted to various parts of the bike including the sissybar or a luggage rack. This Tool Bag is constructed to handle the weight of tools. The bag measures: 5.25" in diameter x 11" long. Internal capacity: 165Cl. Carrying capacity: 5 lbs.

93300113 **\$76.95**

D. WINDSHIELD BAGS

Ideal for storing cell phones, sunglasses and other small items, these easy-to-install bags are available in a wide variety of styles to suit your customizing direction.

Fits King-Size and Compact windshields (except FXSTD, Flame and Skull with Wings). Does not fit 100th Anniversary logo windshields, models equipped with handlebar mount gauges or Road Tech Riser Mount Radio. Also fits '15-later FLRT windshields.

1. FAT BOY® WINDSHIELD BAG WITH CONCHO

56626-99 **\$117.95**

2. WINDSHIELD BAG FOR SOFTAIL® DELUXE MODELS

57207-05A **\$127.95**

3. LEATHER WITH BAR & SHIELD LOGO

58298-87 **\$117.95**

4. EMBOSSED BAR & SHIELD LOGO LEATHER

58308-95 **\$110.95**

5. ROAD KING® CLASSIC LEATHER WINDSHIELD BAG

58189-98 **\$127.95**



A. BLACK STANDARD LINE HANDLEBAR BAG



B. BLACK STANDARD LINE SISSY BAR/SOLO BAG



C. BLACK STANDARD LINE TOOL BAG



D. WINDSHIELD BAGS



E. THREE-POCKET WINDSHIELD POUCH



F. TWO-POCKET WINDSHIELD POUCH



G. HANDLEBAR/FORK BAGS



H. SOFT LEATHER HANDLEBAR/FORK BAG

LUGGAGE 655

Windshield Bags

E. THREE-POCKET WINDSHIELD POUCH

Add convenient storage space up front where you need it. This easy-to-install windshield pouch features three easily accessible storage pockets sized for cell phones, glasses and other small items. The center pouch is accented with an embossed Harley-Davidson script for a finishing touch.

58904-03 **\$136.95**

Fits King-Size (except Heritage Springer™ and Rigid-Mount King Size) and Road King® windshields (except Wind Deflector and Adjustable Height).

F. TWO-POCKET WINDSHIELD POUCH

Add convenient storage space up front where you need it. This easy-to-install windshield pouch features two easily accessible storage pockets sized for cell phones, glasses and other small items. Hook-and-loop closures allow easy one-handed opening. Both pouches are accented with an embossed Harley-Davidson logo for a finishing touch.

57203-07 **\$122.95**

Fits King-Size or Compact windshields. Does not fit FXDWG, FLSTSB or FXSTD models. Does not fit Rigid-Mount, Super Sport, Nostalgic or Flamed windshields.

G. HANDLEBAR/FORK BAGS

Constructed of durable synthetic leather with embossed H-D Eagle Wing logo. Looks great on sissy bar uprights, handlebars and front forks.

If used in front fork application, fits '93-'17 FXDWG and '84-'17 FLSTC models. Also fits '82-'89 FXR with additional purchase of Directional Relocation Kit P/N 90504-82A.

91743-87T 11-inch length. **\$45.95**

91744-87T 8-inch length. **\$39.95**

H. SOFT LEATHER HANDLEBAR/FORK BAG

Features include embroidered logos, full-length hook-and-loop closure over zipper and plush nylon pile inside lining. Features silver Harley-Davidson logo.

91773-85 **\$87.95**

If used in front fork application, fits '93-'17 FXDWG and '84-'17 FLSTC models. Also fits '82-'89 FXR with additional purchase of Directional Relocation Kit P/N 90504-82A.

Model Family Fitment:

- V-ROD
- SPORTSTER
- DYNA
- SOFTAIL
- TOURING

Notice: The prices appearing in this catalog are the manufacturer's suggested retail prices. Actual retail prices may vary.

Notice: The prices appearing in this catalog are the manufacturer's suggested retail prices. Actual retail prices may vary.

656 LUGGAGE

Storage

A. RIDER CUP HOLDER

Shaped to blend with the contours of your Harley-Davidson® motorcycle, this unique cup holder is easy to reach without cluttering the handlebar. The attractive chrome mount securely attaches to the frame downtube and sweeps rearward to support the cup holder. The soft-touch insulated holder flexes to grip the beverage and features a perforated bottom to drain away rain water. Kit includes model-specific clamp, support rod, cup holder and all required mounting hardware.

50700001 \$66.95

Fits '09-later Touring and Trike models. Does not fit '14-later models equipped with Fairing Lower.



A. RIDER CUP HOLDER



B. BUNGEE CORD SOFT-HOOK EXTENSIONS



C. BLACK CARGO NETS

These versatile nets feature vinyl-coated attaching hooks to hold your cargo securely. For helmets, small packages, etc. Works great with chrome bungee nuts.

97008-07 12.0" x 12.0" – 4 hook. \$13.95

98170-88T 15.0" x 15.0" – 6 hook. \$14.95

98169-88T 18.0" x 18.0" – 6 hook. \$15.95

D. BLACK BUNGEE CORDS

98196-85T 18.0" length. \$3.95

98197-85T 24.0" length. \$3.95

98198-85T 30.0" length. \$3.95

98199-85T 24.0" length – 4 hook. \$5.95

E. CHROME BUNGEE NUTS

98185-90T .375" – 16 thread. (pair) \$12.95



C. BLACK CARGO NET

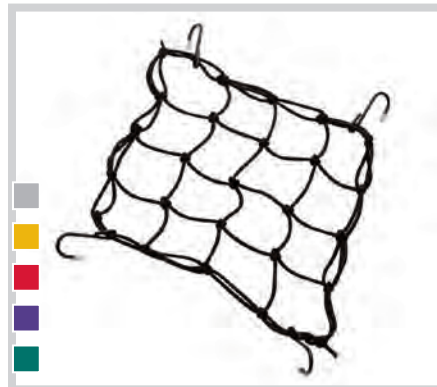

D. BLACK BUNGEE CORDS



E. CHROME BUNGEE NUTS



F. MUSIC PLAYER TANK POUCH



F. MUSIC PLAYER TANK POUCH

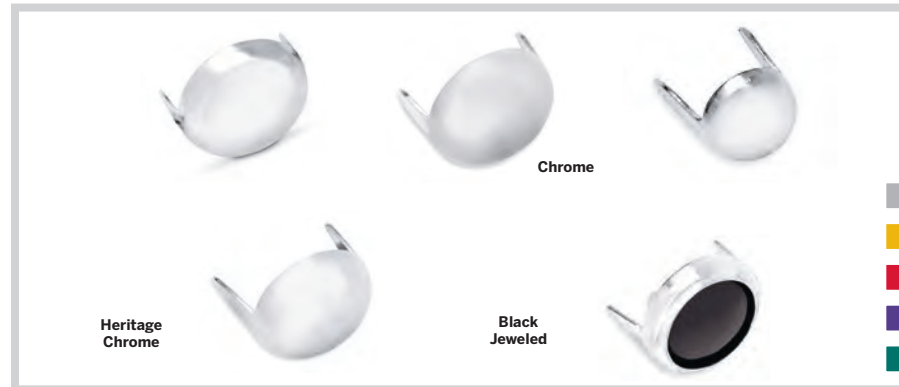

G. DECORATIVE SPOTS



H. HARLEY-DAVIDSON/U.S.A. CUSTOM CONCHO AND LEATHER ROSETTE AND LACING STRAP

LUGGAGE 657

Luggage Accessories

F. MUSIC PLAYER TANK POUCH

This portable music system pouch is designed for motorcycle use. The neoprene jacket offers hardcore protection for your portable music device, while the built-in magnets hold the pouch securely to the fuel tank. The clear play-through window permits touchscreen control and the anti-skid interior allows the pouch to accommodate players of various sizes. The clamshell design makes inserting your player into the pouch quick and easy and the double zipper allows for headphone and output cables to exit the pouch at any point on top, bottom or one side of the pouch. Simply plug in your headphones or connect your in-dash Advanced Audio Radio with an auxiliary cable or iPod® Interface and enjoy your music collection. Works well with many MP3 and other personal music players, but should not be used with hard-disk memory players. Window measurement: 2.25" W x 4.0" H.

76000193 \$50.95

Fits models with steel fuel tanks or airbox covers.

G. DECORATIVE SPOTS

Make your own personal styling statement by identifying your leather jacket, cap, saddlebags, sissy bar bag, etc., with Decorative Spots that are made of rustproof, nickel-plated solid brass. Package quantity 1.

Decorative Chrome Spots

93024-88 Round .50". \$0.25

Decorative Road King® Black Jeweled Spot

93036-95 Matches FLHR models. \$2.95

Decorative Heritage Chrome Spot

93037-09 Matches FLSTC models. \$2.95

H. HARLEY-DAVIDSON®/U.S.A. CUSTOM CONCHO

Conchos are polished, nickel-plated and identified with a recessed Harley-Davidson Motorcycles – U.S.A. logo in contrasting black. Attaches securely with a tie wrap. Rosette & Lacing Strap sold separately.

91857-91 Package quantity 1. \$6.95

Shown with:

LEATHER ROSETTE AND LACING STRAP FOR HARLEY-DAVIDSON/U.S.A. CUSTOM CONCHO

Available in black, these leather accents can be used when attaching H-D® custom conchos.

91722-04 Package quantity 1. \$17.95

Model Family Fitment:

- V-ROD
- SPORTSTER
- DYNA
- SOFTAIL
- TOURING

Notice: The prices appearing in this catalog are the manufacturer's suggested retail prices. Actual retail prices may vary.

Notice: The prices appearing in this catalog are the manufacturer's suggested retail prices. Actual retail prices may vary.

658 LUGGAGE

Flags

A. PREMIUM AMERICAN FLAG KIT

Proudly display Old Glory with this Premium Flag and Mast Kit. The redesigned chrome-plated clamp was engineered to provide a secure mount to your luggage rack. This 14.0" x 11.0" nylon flag is sewn with pillow case stitching for added durability, and the mast features a rich bullet-shaped finial tip. Kit includes American flag, mounting clamp, flag mast and all necessary hardware. (Flags are designed for parade use only and will not withstand highspeed use.)

Fits Air Wing Tour-Pak® Luggage Rack P/N 79179-08, 53000063 or 50300097, Premium Tour-Pak Luggage Rack P/N 53665-87, Contoured Tour-Pak Luggage Rack P/N 79148-06A and all luggage racks with .5" diameter round outer bar.
61400617 \$69.95

B. AMERICAN FLAG KIT

Whether showing your patriotism or your love of Harley® motorcycles, showing your colors is easier than ever with quality flag and mast kits. Flags are made with high-quality nylon for durability. Available in sissy bar mount or Tour-Pak® Luggage Carrier/Saddlebag mount. (Flags are designed for parade use only and will not withstand high-speed use.)

94616-98 Sissy bar. **\$38.95**
 Fits Sissy Bars (except Mini and Short Uprights with Backrest Pads).

61400206 Tour-Pak Mount. **\$43.95**
 Mounts to '14-later Touring and Tri Glide® models with Color-Matched Tour-Pak Luggage Carriers. Does not fit Leather Tour-Pak Luggage.

94626-98 Tour-Pak/Saddlebag Mount. **\$38.95**
 Mounts to '14-later Touring models with Color-Matched Hard Saddlebags, without Tour-Pak Luggage. Does not fit with Electra Glo™ Saddlebag Run/Brake/Turn Lights. Also mounts to '14-later Touring models with Color-Matched Tour-Paks. Does not fit with LED King Tour-Pak Brake/Turn/Tail Lamp Kit P/N 67800368. Also mounts to '93-'13 Touring and Trike models equipped with Color-Matched Tour-Pak luggage carriers or Hard Saddlebags. Does not fit Leather Tour-Pak luggage. Also fits many car and truck roll-down windows.

94625-98 Replacement flag only. **\$23.95**



A. PREMIUM AMERICAN FLAG KIT



B. AMERICAN FLAG KIT



C. 120TH ANNIVERSARY FLAG KIT



D. WOUNDED WARRIOR PROJECT FLAG KIT



E. POW/MIA FLAG KIT

LUGGAGE 659

Flags

C. 120TH ANNIVERSARY FLAG KIT

Celebrate 120 years of riding tradition. Commemorative 120th Anniversary Flags are made with high-quality polyester knit fabric for richer color and sewn with "pillowcase" stitching for added durability.

61400721 Sissy Bar. **\$34.95**
 Mounts to Sissy Bars (except Mini and Short Uprights with Backrest Pads).

61400722 Tour-Pak Mount. **\$39.95**
 Mounts to '14-later Touring and Tri Glide® models with Color-Matched Tour-Pak® Luggage carriers. Does not fit Leather Tour-Pak luggage carrier.

61400723 Tour-Pak/Saddlebag Mount. **\$39.95**
 Mounts to '14-later Touring models with Color-Matched Hard Saddlebags, without Tour-Pak Luggage. Does not fit with Electra Glo™ Saddlebag Run/Brake/Turn Lights. Also mounts to '14-later Touring models with Color-Matched Tour-Pak. Does not fit with LED King Tour-Pak Brake/Turn/Tail Lamp Kit P/N 67800368. Also mounts to '93-'13 Touring and Trike models equipped with Color-Matched Tour-Pak luggage carriers or Hard Saddlebags. Does not fit Leather Tour-Pak luggage. Also fits many car and truck roll-down windows.

D. WOUNDED WARRIOR PROJECT® FLAG KIT

Raise the flag and salute our returning veterans who incurred service-connected injuries or illness. Complete flag and mast kit is easy to install, and features a flag manufactured with high-quality nylon for durability. Available in sissy bar mount or Tour-Pak® Luggage Carrier/Saddlebag mount versions. (Flags are designed for parade use only and will not withstand high-speed use.)

61400374 Sissy Bar. **\$38.95**
 Fits Sissy Bars (except Mini and Short Uprights with Backrest Pads).

61400375 Tour-Pak Mount. **\$43.95**
 Mounts to '14-later Touring and Tri Glide® models with Color-Matched Tour-Pak Luggage Carriers. Does not fit Leather Tour-Pak Luggage.

61400377 Tour-Pak/Saddlebag Mount. **\$38.95**
 Mounts to '14-later Touring models with Color-Matched Hard Saddlebags and mounts to '93-'13 Touring and Trike models equipped with Color-Matched Tour-Pak Luggage carriers or Hard Saddlebags. Does not fit Leather Tour-Pak luggage. Also fits many car and truck roll-down windows.

NOTE: The Wounded Warrior Project (WWP) name and logo are trademarks of Wounded Warrior Project Inc., a tax-exempt 501 (C)(3) nonprofit organization, and are used here with its permission.

E. POW/MIA FLAG KIT

Show support for the American POW and MIA military forces with this flag and mast kit. Flags are made with high-quality nylon for durability. (Flags are designed for parade use only and will not withstand high-speed use).

61400205 Tour-Pak Mount. **\$43.95**
 Mounts to '14-later Touring and Tri Glide models with Color-Matched Tour-Pak Luggage Carriers. Does not fit Leather Tour-Pak Luggage.

94901-03 Tour-Pak/Saddlebag Mount. **\$38.95**
 Mounts to '14-later Touring models with Color-Matched Hard Saddlebags and mounts to '93-'13 Touring and Trike models equipped with Color-Matched Tour-Pak luggage carriers or Hard Saddlebags. Does not fit Leather Tour-Pak luggage. Also fits many car and truck roll-down windows.

94902-03 Replacement POW/MIA flag only. **\$23.95**

Model Family Fitment:

- V-ROD
- SPORTSTER
- DYNA
- SOFTAIL
- TOURING

Notice: The prices appearing in this catalog are the manufacturer's suggested retail prices. Actual retail prices may vary.

Notice: The prices appearing in this catalog are the manufacturer's suggested retail prices. Actual retail prices may vary.



Road Glide® Special in Baja Orange with Color-Matched Accessories

HARLEY-DAVIDSON®

COLOR-SHOP

The bike is a blank canvas, a surface ready to express your personality with design, color and texture. Harley-Davidson color-matched components set the tone for the rest of the accessories and set your bike apart from the crowd.

COLOR-MATCHED BODYWORK

Wish you could splash more of your factory color over your bike's profile? Consider Color Shop's Accessory Bodywork. This collection of primed and color-matched components endows your Harley® motorcycle with a personality of its own. Tour-Pak® luggage, stretched saddlebags, inner fairings, spoilers and more are available in factory-matched colors for most late model Harley motorcycles.



COLOR-MATCHED SLIPSTREAM VENT TRIM AND ROAD GLIDE® HEADLAMP TRIM COVERS

COLOR-MATCHED SPLITSTREAM VENT TRIM – BATWING FAIRING

The batwing fairing is a key visual and functional element of your Touring bike, and the Splitstream vent sits front and center for all to see. Shaped to replace the Original Equipment satin black soft trim, this one-piece rigid component blends into the sweep of the outer fairing and dresses the vent in style. Available in your choice of finishes, this vent trim is the perfect complement to available windshield trim kits.

Fits '14-later Electra Glide®, Street Glide®, Ultra Limited and Tri Glide® models with batwing fairing.

*NOTE: This product is a Paint to Order accessory. Please allow for an average of 5 weeks' delivery for this item.

COLOR-MATCHED ROAD GLIDE® HEADLAMP TRIM

This sleek one-piece headlamp surround adds a clean custom look to the nose of the Road Glide® model. The easy-to-install Headlamp Trim hugs the dual headlamps and covers the matte black factory bezel for a menacing aerodynamic appearance. The swept back look and the knife-edge side strakes emphasize the streamlined shape of the fairing without impeding airflow to the vents or obstructing headlamp light patterns. Available in your choice of finish, the self-adhesive Headlamp Trim can be installed without removing the headlamp or fairing.

Fits '15-later Road Glide models.



Solid Color

	P/N	P/N
Atlas Silver Metallic	61300461EWZ	61400412EWZ
Baja Orange	61300461ESS	61400412ESS
Barracuda Silver	61300461EKR	61400412EKR
Barracuda Silver Denim	61300461ENR	—
Billiard Blue	—	61400412EKP
Billiard Burgundy	61300461ENZ	—
Billiard Gray	61300461EXU	61400412EXU
Billiard Red	61300461ENX	61400412ENX
Billiard Teal	—	61400412ESK
Black Jack Metallic	61300461ESC	—
Blue Max	—	61400412ELE
Bonneville Salt Denim	61300461EFW	—
Bright Billiard Blue	61300461EXB	61400412EXB
Chrome	61300505	61400411
Deadwood Green	61300461ESU	—
Gauntlet Gray Metallic	61300461ESH	61400412ESH
Gray Haze	61300461EWX	61400412EWX
Gunship Gray	61300461EGZ	61400412EGZ
Heirloom Black	—	61400412EWK
Heirloom Red	61300461EWI	61400412EWI
Industrial Gray Denim	61300461EFC	—
Industrial Yellow	61300461EXE	61400412EXE
Midnight Blue	61300461EKA	61400412EKA
Midnight Crimson	61300461ESN	61400412ESN
Mineral Green Metallic	—	61400412EVG
Prospect Gold	61300461EXF	61400412EXF
Redline Red	61300461EUZ	61400412EUZ
Reef Blue	—	61400412EVA
River Rock Gray	61300461ENT	61400412ENT
Scorched Orange	61300461ELG	61400412ELG
Silver Fortune	61300461EFP	61400412EFP
Silver Pine	61300461EOR	61400412EOR
Snake Venom	61300461ETF	61400412ETF
Spruce	—	61400412EOG
Tahitian Teal (CPP)	61300461EOX	—
Twisted Cherry	61300461EFH	—
Vivid Black	61300461DH	61400412DH
White Sand Pearl	61300461EVD	61400412EVD
Wicked Red	61300461EFF	61400412EFF
Zephyr Blue (CPP)	—	61400412EPB

Note: Check your local dealership for more information

COLOR-MATCHED CUSTOM WRAPPED FRONT FENDER

Give your bike a big hug. This all-steel fender is shaped to show off the full profile of your 19" front wheel. The apron-less fender wraps almost 180 degrees around the front tire for a clean, custom appearance, and the low-profile cutaway design exposes the wheel from hub to rim for maximum visual impact. Designed for mistake-proof installation, the fender is pre-drilled to fit Original Equipment fender mounting bosses, and does not require additional fender spacers or install kits. Available in Color-Matched, Vivid Black or primed and ready-to-paint finish.

Fits '14-later Touring models equipped with 17", 18" or 19" wheel and tire combination. Does not fit with Fender Tip Assembly P/N 59600003 or 59600006. Does not fit Trike or FLTRXSE models.



WRAPPED FRONT FENDER

COLOR-MATCHED 21" FRONT FENDER

Required for use with the Knockout™ Custom Wheel Kit.

Fits '17-later FLTRX and FLTRXS models equipped with Knockout Wheel Kit P/N 43300494 or 43300496.



21" FRONT FENDER

COLOR-MATCHED CUSTOM CHOPPED FRONT FENDER

This all-steel Chopped Front Fender is a key element of West Coast style for Touring models. The trimmed profile gives the front end a tough pro-touring look and exposes the wheel from hub to rim for maximum visual impact. Designed for mistake-proof installation. Pre-drilled to fit Original Equipment fender mounting bosses, and does not require additional fender spacers or install kits.

Fits '14-later Touring models equipped with 17", 18" or 19" wheel and tire combination. Does not fit with Fender Tip Assembly P/N 59600003 or 59600006. Does not fit Trike models.



CHOPPED FRONT FENDER

COLOR-MATCHED CUSTOM WRAPPED FENDERS

Color	Custom Wrapped Front Fender	21" Front Fender	Chopped Front Fender
	P/N	P/N	P/N
Atlas Silver Metallic	58900196EWZ	58900336EWZ	58900591EWZ
Baja Orange	58900196ESS	58900336ESS	58900591ESS
Billiard Blue	58900196EKP	58900336EKP	—
Billiard Red	58900196ENX	—	—
Billiard Red/Vivid Black	58900527EOU	58900529EOU	—
Billiard Teal	58900196ESK	58900336ESK	—
Black Denim	—	58900336BYM	58900591BYM
Black Jack Metallic	58900196ESC	—	—
Bright Billiard Blue	58900196EXB	—	58900591EXB
Bright Billiard Blue / Billard Gray	58900527EXK	58900529EXK	58900594EXK
Deadwood Green	58900196ESU	—	—
Deadwood Green Denim	58900196ESW	—	—
Gauntlet Gray Metallic	58900196ESH	58900336ESH	—
Gauntlet Gray Metallic/Vivid Black	58900527ESZ	58900529ESZ	—
Gray Haze	58900196EWX	58900336EWX	58900591EWX
Gunship Gray	58900196EGZ	58900336EGZ	58900591EGZ
Heirloom Red Fade	58900360EWJ	58900631EWJ	58900598EWJ
Industrial Gray	58900196EEZ	—	—
Industrial Gray Denim	58900196EFC	—	—
Industrial Yellow	58900196EXE	—	58900591EXE
Industrial Yellow / Vivid Black	58900527EXN	58900529EXN	58900594EXN
Legend Blue/Vivid Black	58900196EEM	—	—
Midnight Crimson	58900196ESN	58900336ESN	58900591ESN
Midnight Crimson/Vivid Black	58900527EVO	—	58900594EVO
Mineral Green Denim	58900196EVI	—	58900591EVI
Mineral Green Metallic	58900196EVG	—	—
Primed	58900196BEO	58900319	58900590
Prospect Gold	58900196EXF	58900336EXF	58900591EXF
Redline Red	58900196EUZ	58900336EUZ	58900591EUZ
Reef Blue	58900196EVA	58900336EVA	58900591EVA
Reef Blue/Vivid Black	58900527EVR	58900529EVR	58900594EVR
River Rock Gray	58900196ENT	58900336ENT	—
Scorched Orange/Silver Flux (CPP)	—	58900400EOY	—
Snake Venom	58900196ETF	58900336ETF	—
Vivid Black	58900196DH	58900336DH	58900591DH
White Sand Pearl	58900196EVD	58900336EVD	58900591EVD
Wicked Red	58900196EFF	—	—

CVO™ Model Color	P/N	P/N	P/N
Great White Pearl & Black Hole	58900360ERP	—	—
Sunset Orange Fade & Sunset Black	58900360ERL	—	—
Blue Steel	58900196EUB	—	58900591EUB
Bronze Armor	58900196ERI	—	—
Envious Fade	58900360EUK	—	58900596EUK
Gunship Gray	58900196EGZ	—	—
Hightail Yellow Pearl	58900360EUE	—	58900598EUE

Note: Check your local dealership for more information

COLOR-MATCHED ROAD GLIDE® FAIRING SPOILER AND CHIN SPOILER

COLOR-MATCHED ROAD GLIDE® FAIRING SPOILER

Add a custom touch to your motorcycle with a Color-Matched Road Glide® Fairing Spoiler. Designed to replace the Original Equipment Road Glide Fairing Spoiler.

Fits '17-later FLTRX and FLTRXS models. '17-'20 FLTRXS and '17-later FLTRX models require separate purchase of Chopped Engine Guard P/N 49000117A. Does not fit with Heavy Breather Extreme Air Cleaners P/N's 29400388 or 29400387.

COLOR-MATCHED CHIN SPOILER

The Touring Chin Spoiler Kit gives a touch of factory color and style to the front of your Touring motorcycle. Kit includes all the required mounting hardware. Best of all, it's Genuine Harley-Davidson for the perfect fit and unmatched custom style.

Fits '17-later Road King®, Street Glide®, Road Glide® (except FLTRXSE models), and Electra Glide® Standard models.



ROAD GLIDE FAIRING SPOILER



	Road Glide® Fairing Spoiler	FL Chin Spoiler
Atlas Silver Metallic	57001042EWZ	57200261EWZ
Baja Orange	57001042ESS	57200261ESS
Barracuda Silver	—	57200261EKR
Billiard Blue	57001042EKP	—
Billiard Gray	57001042EXU	57200261EXU
Billiard Red	57001042ENX	57200261ENX
Billiard Teal	57001042ESK	57200261ESK
Black Denim	—	57200261BYM
Black Jack Metallic	—	57200261ESC
Bright Billiard Blue	—	57200261EXB
Deadwood Green	—	57200261ESU
Gauntlet Gray Metallic	57001042ESH	57200261ESH
Gray Haze	57001042EWX	57200261EWX
Gunship Gray	57001042EGZ	57200261EGZ
Heirloom Red	57001042EWI	57200261EWI
Industrial Gray Denim	57001042EFC	—
Industrial Yellow	—	57200261EXE
Midnight Crimson	57001042ESN	57200261ESN
Mineral Green Denim	—	57200261EVI
Prospect Gold	57001042EXF	57200261EXF
Raw	57001234	—
Redline Red	57001042EUZ	57200261EUZ
Reef Blue	57001042EVA	57200261EVA
River Rock Gray	57001042ENT	—
River Rock Gray Denim	57001042ENV	57200261ENV
Scorched Orange	57001042ELG	57200261ELG
Silver Pine	—	57200261EOR
Snake Venom	57001042ETF	57200261ETF
Vivid Black	57001042DH	57200261DH
White Sand Pearl	57001042EVD	57200261EVD
Wicked Red	57001042EFF	—
Wicked Red Denim	57001042EKG	—
Zephyr Blue	57001042EPB	57200261EPB

Note: Check your local dealership for more information

COLOR-MATCHED CUSTOM STRETCHED SIDE COVERS AND VENTED FAIRING LOWERS

COLOR-MATCHED VENTED FAIRING LOWER KIT*

These Fairing Lower Kits feature a venting system that allows you to adjust the amount of air that circulates across the engine. The ratcheting friction lock pivot allows you to easily set the position. NOTE: Fairing Lower Kits are painted in a single color and do not feature pinstriping.

Fits '14-later Air-Cooled Touring (except '18-later FLTRXSE models) and Trike models. Does not fit models with Twin-Cooled™ engines. Freewheeler® models require separate purchase of Engine Guard P/N 49184-09A or 49050-09A and Bracket P/N 45700054. Does not fit with Mustache Engine Guards, Chopped Engine Guards or Knockout Wheel Kit P/N 43300494 or 43300496.

FAIRING LOWER SPEAKER BOXES – Available to fit:

Fits '14-later Touring (except Road King and CVO™) models equipped with vented fairing lowers and Boom!™ Audio Fairing Lower Speaker Kit P/N 76000487 or 76000353. Does not fit models with Twin-Cooled™ engines.



Boom! Fairing Lower Speaker Box
Fits '14-later models

	Vented Fairing Lower Kit	Boom! Fairing Lower Speaker Box
Solid Color	P/N	P/N
Primed/Paintable	57100258	57100233
Atlas Silver Metallic	57100257EWZ	76000497EWZ
Baja Orange	57100257ESS	76000497ESS
Barracuda Silver	—	76000497EKR
Barracuda Silver Denim	—	76000497ENR
Billiard Blue	57100257EKP	76000497EKP
Billiard Burgundy	57100257ENZ	76000497ENZ
Billiard Gray	57100257EXU	76000497EXU
Billiard Red	57100257ENX	76000497ENX
Billiard Teal	57100257ESK	76000497ESK
Black Jack Metallic	57100257ESC	76000497ESC
Blue Max	57100257ELE	76000497ELE
Bright Billiard Blue	57100257EXB	76000497EXB
Deadwood Green Denim	57100257ESW	76000497ESW
Gauntlet Gray Metallic	57100257ESH	76000497ESH
Gray Haze	57100257EWX	76000497EWX
Gunship Gray	57100257EGZ	76000497EGZ
Heirloom Red	57100257EWI	76000497EWI
Industrial Gray	—	76000497EEZ
Industrial Gray Denim	57100257EFC	—
Industrial Yellow	57100257EXE	76000497EXE
Kinetic Green	—	76000497ELD
Midnight Blue	—	76000497EKA
Midnight Crimson	57100257ESN	76000497ESN
Mineral Green Denim	57100257EVI	—
Prospect Gold	57100257EXF	76000497EXF
Redline Red	57100257EUZ	76000497EUZ
Reef Blue	57100257EVA	76000497EVA
River Rock Gray	57100257ENT	76000497ENT
River Rock Gray Denim	57100257ENV	76000497ENV
Scorched Orange	57100257ELG	76000497ELG
Silver Flux	—	76000497ELI
Snake Venom	57100257ETF	76000497ETF
Spruce	—	76000497EOG
Stiletto Red (CPP)	57100257EOW	76000497EOW
Stone Washed White Pearl	57100257EOB	—
Superior Blue	57100257DWC	76000497DWC
Tahitian Teal (CPP)	—	76000497EOX
Twisted Cherry	57100257EFH	—
Velocity Red Sunglo	57100257DZT	—
Vivid Black	57100257DH	76000497DH
White Sand Pearl	57100257EVD	76000497EVD
Wicked Red	57100257EFF	76000497EFF
Wicked Red Denim	57100257EKG	76000497EKG
Zephyr Blue (CPP)	57100257EPB	—

Note: Check your local dealership for more information

*NOTE: This product is a Paint to Order accessory. Please allow for an average of 5 weeks' delivery for this item.

COLOR-MATCHED STRETCHED SADDLEBAG BOTTOMS

COLOR-MATCHED STRETCHED SADDLEBAG BOTTOMS*

Add the long, low “slammed” look to your Touring bike without compromising the suspension travel and ride height. These Stretched Saddlebag Bottoms wrap around the exhaust to add visual length to the bike and hide the muffler bracket and hanger from view. Stretched Bottoms are predrilled to accept your existing saddlebag lids and latches. Simply attach the extended saddlebag bottom to your saddlebag lids with the included hardware and install on the bike like the original bags.

Available to fit:
Fits '14-later Touring models (except FLTRXSE) with Color-Matched Hard Saddlebags.

*NOTE: This product is a Paint to Order accessory. Please allow for an average of 5 weeks' delivery for this item.



Solid Color	Inner/Outer Pinstripe	Stretched Saddlebag Bottoms Fits '14-later models
		P/N
Primed/Paintable	—	90201107
Blue Max	—	90201953ELE
Kinetic Green	—	90201953ELD
Spruce	—	90201078EOG
Tahitian Teal	—	90202005EOX
Vivid Black	—	90201078DH
CVO™ Model Colors	Panel Inner/Outer Pinstripe	
Auburn Sunglo	Black Hole/Rich Bourbon	90201905EHT
Magnetic Gray	Red Pepper/Wineberry	90201905EHX

Note: Check your local dealership for more information

SADDLEBAG SPEAKER LIDS

SPEAKER LIDS

Custom Color-Matched covers are shaped to accommodate Saddlebag Lid Speakers. Speaker openings are formed to angle the speakers and direct the sound forward toward the rider and passenger. Installation reuses Original Equipment hinges, locks and mounting hardware.

SADDLEBAG LID SPEAKERS – Available to fit:

Fits '14-later Touring (except Road King) models equipped Harley-Davidson® Audio powered by Rockford Fosgate® or Boom!™ Audio Saddlebag Speakers.

Solid Color	Boom! Saddlebag Lid–Left Fits '14-later models	Boom! Saddlebag Lid–Right Fits '14-later models
	P/N	P/N
Primed/Paintable	90201109	90201108
Atlas Silver Metallic	90200827EWZ	90200826EWZ
Baja Orange	90200827ESS	90200826ESS
Barracuda Silver Denim	90200827ENR	90200826ENR
Billiard Blue	90200827EKP	90200826EKP
Billiard Burgundy	90200827ENZ	90200826ENZ
Billiard Red	90200827ENX	90200826ENX
Billiard Teal	90200827ESK	90200826ESK
Black Denim	90200827BYM	90200826BYM
Black Jack Metallic	90200827ESC	90200826ESC
Black Tempest	90200827EEV	90200826EEV
Black with Royal Black	90200827ERG	90200826ERG
Blue Max	90200827ELE	90200826ELE
Bonneville Salt Pearl	90200827EFU	90200826EFU
Bright Billiard Blue	90200827EXB	90200826EXB
Bronze Armor	90200827ERI	90200826ERI
Charcoal Denim	90200827DZN	90200826DZN
Deadwood Green	90200827ESU	90200826ESU
Electric Blue	90200827EFM	90200826EFM
Gauntlet Gray Metallic	90200827ESH	90200826ESH
Gray Haze	90200827EWX	90200826EWX
Gunship Gray	90200827EGZ	90200826EGZ
Heirloom Black	90200827EWK	90200826EWK
Heirloom Red	90200827EWI	90200826EWI
Industrial Gray Denim	90200827EFC	90200826EFC
Industrial Yellow	90200827EXE	90200826EXE
Kinetic Green	90200827ELD	90200826ELD
Legend Blue	90200827EEN	90200826EEN
Midnight Blue	90200827EKA	—
Midnight Crimson	90200827ESN	90200826ESN
Mineral Green Metallic	90200827EVG	90200826EVG
Performance Orange	90200827EOE	90200826EOE
Prospect Gold	90200827EXF	90200826EXF
Redline Red	90200827EUZ	90200826EUZ
Reef Blue	90200827EVA	90200826EVA
River Rock Gray	90200827ENT	90200826ENT
River Rock Gray Denim	90200827ENV	90200826ENV
Scorched Orange	90200827ELG	90200826ELG
Silver Pine	90200827EOR	90200826EOR
Snake Venom	90200827ETF	90200826ETF
Spruce	90200827EOG	90200826EOG
Stiletto Red	90200827EOW	90200826EOW
Stone Washed White Pearl	90200827EOB	90200826EOB
Superior Blue	90200827DWC	90200826DWC
Twisted Cherry	90200827EFH	90200826EFH
Velocity Red Sunglo	90200827DZT	90200826DZT
Vivid Black	90200827DH	90200826DH
White Sand Pearl	90200827EVD	90200826EVD
Wicked Red	90200827EFF	90200826EFF
Wicked Red Denim	90200827EKG	90200826EKG
Zephyr Blue	90200827EPB	90200826EPB
CVO™ Model Primary Color		
Auburn Sunglo with Black Hole/Rich Bourbon	90201906EHT	90201907EHT
Charcoal Slate	90200827BYZ	90200826BYZ
Dantes Black (CVO)	90200827EWC	90200826EWC
Hightail Yellow Pearl (CVO)	90200827ETY	90200826ETY
Magnetic Gray with Wineberry/Red Pepper	90201906EHX	90201907EHX
Moonlight Blue	90200827EMA	90200826EMA
Wicked Orange Pearl (CVO)	90200827ETX	90200826ETX

Note: Check your local dealership for more information

*NOTE: This product is a Paint to Order accessory. Please allow for an average of 5 weeks' delivery for this item.

COLOR-MATCHED INNER FAIRING KIT – BATWING

COLOR-MATCHED INNER FAIRING KIT*

Add a custom touch to your motorcycle with a Color-Matched Inner Fairing and Fairing Cap. Designed to replace the Original Equipment matte black inner fairing, the color-matched finish offers a brilliant contrast to the gauge faces and accessory chrome instrument bezels.

COLOR-MATCHED BATWING INNER FAIRING – Available to fit:

Fits '14-later Electra Glide®, Street Glide® and Ultra Limited models with handlebar mounted mirrors. Kit includes inner fairing, fairing cap, and media door. Does not fit Tri Glide® models.

Fits '14-later Street Glide models with fairing mounted mirrors. Kit includes inner fairing, fairing cap, and media door. Does not fit Tri Glide models.

COLOR-MATCHED TRIKE INNER FAIRING – Available to fit:

Fits '14-later Tri Glide models. Kit includes inner fairing, fairing cap, and media door.



*NOTE: This product is a Paint to Order accessory. Please allow for an average of 5 weeks' delivery for this item.

Solid Color	BatwingInnerFairing Fits'14-laterElectraGlide® StreetGlide®andUltraLimitedmodelswith handlebarmountedmirrors	BatwingInnerFairing Fits'14-laterStreetGlide®modelswith airmountedmirrors	BatwingInnerFairing Fits'14-laterTriGlide®models
	P/N	P/N	P/N
Atlas Silver Metallic	—	57000389EWZ	—
Baja Orange	—	57000389ESS	—
Barracuda Silver	—	57000389EKR	—
Barracuda Silver Denim	57000387ENR	—	—
Billiard Blue	—	57000389EKP	—
Billiard Burgundy	—	57000389ENZ	—
Billiard Gray	57000387EXU	—	—
Billiard Red	57000387ENX	57000389ENX	57000388ENX
Black Jack Metallic	57000387ESC	57000389ESC	—
Black Tempest	57000387EEV	—	—
Bright Billiard Blue	—	57000389EXB	—
Deadwood Green	57000387ESU	57000389ESW	57000388ESU
Deadwood Green Denim	—	57000389ESW	—
Gauntlet Gray Metallic	57000387ESH	57000389ESH	57000388ESH
Gray Haze	57000387EWX	57000389EWX	—
Gunship Gray	57000387EGZ	57000389EGZ	—
Heirloom Red	57000387EWI	57000389EWI	—
Industrial Yellow	—	57000389EXE	—
Kinetic Green	—	57000389ELD	57000388ELD
Legend Blue	—	—	57000388EEN
Midnight Blue	—	57000389EKA	57000388EKA
Midnight Crimson	57000387ESN	57000389ESN	—
Performance Orange	—	57000389EOE	—
Prospect Gold	—	57000389EXF	—
Redline Red	57000387EUZ	57000389EUZ	—
River Rock Gray	—	57000389ENT	—
River Rock Gray Denim	57000387ENV	—	—
Scorched Orange	57000387ELG	57000389ELG	57000388ELG
Silver Flux	57000387ELI	57000389ELI	—
Silver Fortune	57000387EFP	57000389EFP	57000388EFP
Silver Pine	57000387EOR	—	—
Snake Venom	57000387ETF	57000389ETF	57000388ETF
Stiletto Red	57000387EOW	57000389EOW	—
Spruce	—	—	57000388EOG
Tahitian Teal	—	57000389EOX	—
Vivid Black	57000387DH	57000389DH	57000388DH
White Sand Pearl	57000387EVD	57000389EVD	—
Wicked Red	57000387EFF	57000389EFF	57000388EFF
Wicked Red Denim	—	57000389EKG	—
Zephyr Blue	57000387EPB	57000389EPB	57000388EPB

Note: Check your local dealership for more information

COLOR-MATCHED INNER FAIRING KIT – ROAD GLIDE®

COLOR-MATCHED INNER FAIRING KIT*

Add a custom touch to your motorcycle with a Color-Matched Inner Fairing and Fairing Cap. Designed to replace the Original Equipment matte black inner fairing, the color-matched finish offers a brilliant contrast to the gauge faces and accessory chrome instrument bezels.

COLOR-MATCHED ROAD GLIDE® INNER FAIRING – Available to fit:

Fits '15-later Road Glide® models. Kit includes Color-Matched instrument housing. Color-Matched Inner Fairing Air Duct sold separately.

COLOR-MATCHED ROAD GLIDE AIR DUCT – Available to fit:

Fits '15-later Road Glide models. Color-Matched Inner Fairing sold separately. Kit includes air duct baffle and actuator assembly.



*NOTE: This product is a Paint to Order accessory. Please allow for an average of 5 weeks' delivery for this item.

Solid Color	Road Glide Inner Fairing Fits '15-later models	Road Glide Fairing Air Duct Fits '15-later models
	P/N	P/N
Atlas Silver Metallic	57000482EWZ	29200102EWZ
Baja Orange	57000482ESS	29200102ESS
Billiard Blue	57000482EKP	29200102EKP
Billiard Gray	57000482EXU	29200102EXU
Billiard Teal	57000482ESK	29200102ESK
Blue Max	57000482ELE	29200102ELE
Bright Billiard Blue	57000482EXB	29200102EXB
Gauntlet Gray Metallic	57000482ESH	29200102ESH
Gray Haze	57000482EWX	29200102EWX
Gunship Gray	57000482EGZ	29200102EGZ
Heirloom Red	57000482EWI	29200102EWI
Industrial Yellow	57000482EXE	29200102EXE
Midnight Blue	57000482EKA	29200102EKA
Midnight Crimson	57000482ESN	29200102ESN
Mineral Green Metallic	57000482EVG	29200102EVG
Prospect Gold	57000482EXF	29200102EXF
Redline Red	57000482EUZ	29200102EUZ
Reef Blue	57000482EVA	29200102EVA
River Rock Gray	57000482ENT	29200102ENT
River Rock Gray Denim	57000482ENV	29200102ENV
Scorched Orange	57000482ELG	29200102ELG
Silver Fortune	57000482EFP	29200102EFP
Silver Pine	57000482EOR	29200102EOR
Snake Venom	57000482ETF	29200102ETF
Spruce	57000482EOG	29200102EOG
Vivid Black	57000482DH	29200102DH
White Sand Pearl	57000482EVD	29200102EVD
Wicked Red	57000482EFF	29200102EFF

Note: Check your local dealership for more information

KING TOUR-PAK® LUGGAGE – '14-LATER MODELS



Available to fit:
Fits '14-later Road King®, Road Glide®, Street Glide®, Electra Glide® Standard, and select CVO™ models. Separate purchase of H-D® Detachables™ Two-Up or Solo Tour-Pak® Mounting Rack and applicable Docking Hardware is required. Separate purchase of Tour-Pak Lock Kit P/N 90300030 is required.

CHOPPED TOUR-PAK LUGGAGE – '14-LATER MODELS



Available to fit:
Fits '14-later Road King, Road Glide, Street Glide, Electra Glide Standard, and select CVO models. Does not fit FLRT models. Separate purchase of H-D Detachables Two-Up or Solo Tour-Pak Mounting Rack and applicable Docking Hardware is required. Separate purchase of Tour-Pak Lock Kit P/N 90300030 is required.

Solid Color	King Tour-Pak® Luggage	Chopped Tour-Pak Luggage
	P/N	P/N
Primed/Paintable	53000404	53000405
Atlas Silver Metallic (Black Hardware)	53000775EWZ	53000776EWZ
Atlas Silver Metallic (Chrome Hardware)	53000399EWZ	53000402EWZ
Baja Orange (Chrome Hardware)	53000399ESS	53000402ESS
Billiard Blue	53000399EKP	53000402EKP
Billiard Burgundy (Black Hardware)	53000775ENZ	—
Billiard Red (Black Hardware)	53000775ENX	53000776ENX
Billiard Red (Chrome Hardware)	53000399ENX	53000402ENX
Billiard Teal (Chrome Hardware)	53000399ESK	53000402ESK
Black Denim	53000399BYM	53000402BYM
Black Jack Metallic (Black Hardware only)	53000775ESC	53000776ESC
Blue Max	53000736ELE	53000731ELE
Bonneville Salt Pearl	53000399EFU	53000402EFU
Bright Billiard Blue (Black Hardware)	53000775EXB	53000776EXB
Charcoal Denim	53000399DZN	—
Deadwood Green (Black Hardware)	53000775ESU	53000776ESU
Deadwood Green Denim (Chrome Hardware)	53000775ESW	53000776ESW
Gauntlet Gray Metallic (Black Hardware)	53000775ESH	53000776ESH
Gauntlet Gray Metallic (Chrome Hardware)	53000399ESH	53000402ESH
Gray Haze (Chrome Hardware)	53000399EWX	53000402EWX
Gunship Gray (Black Hardware)	53000775EGZ	53000776EGZ
Gunship Gray (Chrome Hardware)	53000399EGZ	53000402EGZ
Heirloom Red Fade (Black Hardware)	53000983EWJ	53000985EWJ
Hot Rod Red Flake-Solid (HCC)	—	53000402ECN
Industrial Gray Denim	53000399EFC	53000402EFC
Industrial Yellow (Black Hardware)	53000775EXE	53000776EXE
Kinetic Green	—	53000731ELD
Laguna Orange	53000574ECL	—
Midnight Blue	53000399EKA	—
Midnight Crimson (Black Hardware)	53000775ESN	53000776ESN
Midnight Crimson (Chrome Hardware)	53000399ESN	53000402ESN
Mineral Green Denim (Black Hardware)	53000775EVI	53000776EVI
Olive Gold	53000399DZW	—
Performance Orange (Black Hardware)	53000775EOE	53000776EOE
Prospect Gold (Black Hardware)	53000775EXF	53000776EXF
Redline Red (Chrome Hardware)	53000399EUZ	53000402EUZ
Redline Red (Black Hardware)	53000775EUZ	53000776EUZ
Reef Blue (Chrome Hardware)	53000399EVA	53000402EVA
River Rock Gray (Chrome Hardware)	53000399ENT	53000402ENT
Snake Venom (Black Hardware)	53000775ETF	53000776ETF
Snake Venom (Chrome Hardware)	53000399ETF	53000402ETF
White Sand Pearl (Black Hardware)	53000775EVD	53000776EVD
White Sand Pearl (Chrome Hardware)	53000399EVD	53000402EVD

Note: Color-Matched Tour-Pak® luggage carriers do not include backrest pads. Check your local dealership for more information

KING TOUR-PAK® & CHOPPED TOUR-PAK LUGGAGE (continued)

Solid Color	King Tour-Pak® Luggage	Chopped Tour-Pak Luggage
	P/N	P/N
Reef Blue (Chrome Hardware)	53000399EVA	53000402EVA
River Rock Gray (Black Hardware)	53000775ENT	53000776ENT
River Rock Gray (Chrome Hardware)	53000399ENT	53000402ENT
River Rock Gray Denim (Black Hardware)	53000775ENV	53000776ENV
River Rock Gray Denim (Chrome Hardware)	53000399ENV	53000402ENV
Silver Fortune	53000399EFP	53000402EFP
Snake Venom (Black Hardware)	53000775ETF	53000776ETF
Snake Venom (Chrome Hardware)	53000399ETF	53000402ETF
Spruce (Chrome Hardware)	—	53000402EOG
Stiletto Red (Chrome Hardware)	53000779EOW	—
Stone Washed White Pearl (Black Hardware)	53000775EOB	53000776EOB
Sumatra Brown	53000399EFD	—
Superior Blue	53000399DWC	53000402DWC
Tahitian Teal (Chrome Hardware)	53000779EOX	53000780EOX
Twisted Cherry	53000399EFH	53000402EFH
Vivid Black	53000399DH	53000402DH
Vivid Black (Black Hardware)	53000775DH	53000776DH
White Sand Pearl (Black Hardware)	53000775EVD	53000776EVD
White Sand Pearl (Chrome Hardware)	53000399EVD	53000402EVD
Wicked Red	53000399EFF	53000402EFF
Wicked Red Denim	53000399EKG	53000402EKG

Two Tone Solid Color/Panel	Inner/Outer Pinstripe	King Tour-Pak® Luggage	Chopped Tour-Pak Luggage
		P/N	P/N
Billiard Red/ Vivid Black (Black Hardware)		53000866EOU	53000867EOU
Billiard Red/Vivid Black (Chrome Hardware)		53000901EOU	53000900EOU
Bright Billiard Blue/Billiard Gray (Black Hardware)		53000866EXK	53000867EXK
Bright Billiard Blue/Billiard Gray (Chrome Hardware)		53000901EXK	53000900EXK
Electric Blue/Silver Fortune	Blue/Warm Silver	—	53000375EGA
Gauntlet Gray Metallic / Vivid Black (Black Hardware)		53000866ESZ	53000867ESZ
Gauntlet Gray Metallic / Vivid Black (Chrome Hardware)		53000901ESZ	53000900ESZ
Industrial Yellow/Vivid Black (Black Hardware)		53000866EXN	53000867EXN
Legend Blue/Vivid Black	Blue/Medium Silver/Blue	53000643EEM	—
Midnight Crimson/Vivid Black (Black Hardware)		53000866EVO	53000867EVO
Midnight Crimson/Vivid Black (Chrome Hardware)		53000901EVO	53000900EVO
Reef Blue/Vivid Black (Black Hardware)		53000866EVR	53000867EVR
Reef Blue/Vivid Black (Chrome Hardware)		53000901EVR	53000900EVR
Scorched Orange/Black Denim	Black	53000662ELF	—
Scorched Orange/Silver Flux (Black Hardware)	Black	53000777EOY	53000778EOY
Silver Flux/Black Fuse	Black	53000662ELH	53000660ELH
Silver Pine/Spruce (Chrome Hardware)	Black/Sage Green	—	53000375EOO
Zephyr Blue/Black Sunglo (Black Hardware)	Light Cobalt	53000777EPA	53000778EPA

KING TOUR-PAK® LUGGAGE – '09-'13 MODELS



Available to fit:
Fits '09-'13 Electra Glide® Standard, Road King®, Road Glide®, Street Glide®, Street Glide Trike and select CVO™ models. Separate purchase of detachable Two-Up or Solo Tour-Pak® Mounting Rack and applicable Docking Hardware is required. Separate purchase of Tour-Pak Lock Kit P/N 53194-07 is required. FLHXXX models require addition of Tour-Pak Installation Kit P/N 54144-10 and Spacer Kit P/N 83294-10.

53963-10DH Vivid Black. **\$1,066.95**

Fits '06-'08 Electra Glide Standard, Road King, Road Glide and Street Glide models. Separate purchase of detachable Two-Up or Solo Tour-Pak Mounting Rack and applicable Docking Hardware is required. Separate purchase of Tour-Pak Lock Kit P/N 53194-07 is required.

53270-06DH Vivid Black. **\$1,066.95**

NOTE: Color-Matched Tour-Paks do not include backrest pads.

674 COLOR SHOP

Color-Matched Accessories

CVO™ KING & CHOPPED TOUR-PAK® LUGGAGE

KING TOUR-PAK®

Available to fit:

Fits '14-later Road King®, Road Glide®, Street Glide®, Electra Glide® Standard, and select CVO™ models. Separate purchase of H-D® Detachables™ Two-Up or Solo Tour-Pak® Mounting Rack and applicable Docking Hardware is required. Separate purchase of Tour-Pak Lock Kit P/N 90300030 is required.

CHOPPED TOUR-PAK

Available to fit:

Fits '14-later Road King, Road Glide, Street Glide, Electra Glide Standard, and select CVO models. Does not fit FLRT models. Separate purchase of H-D Detachables Two-Up or Solo Tour-Pak Mounting Rack and applicable Docking Hardware is required. Separate purchase of Tour-Pak Lock Kit P/N 90300030 is required.

CVO™ Model Primary Color	King Tour-Pak® Luggage P/N	Chopped Tour-Pak Luggage P/N
Black Earth with Vivid Black	53000654EHA	53000651EHA
Black Forest	53000652EJD	53000649EJD
Black Forest with Wineberry	53000654EJC	53000651EJC
Black Hole with Graphics (Road Glide)	53000833ERS	53000830ERS
Black Stardust	53000833ELZ	53000830ELZ
Blue Steel	53000955EUI	53000946EUI
Bronze Armor with Graphics (Road Glide/Street Glide)	53000833ERT	53000830ERT
Charred Steel with Lightning Silver	53000663EJB	53000651EJB
Envious Fade	53000960EUL	53000963EUL
Great White Pearl & Black Hole with Wicked Red (Street Glide)	53000653ERP	53000650ERP
Gunship Gray	53000652EGZ	53000649EGZ
Hightail Yellow Pearl	53000653EUF	53000835EUF
Lightning Silver and Charcoal Steel with Black Hole	53000700EJE	53000699EJE
Mako Shark	53000652EJH	53000649EJH
Red Pepper and Magnetic Gray with Black Hole	53000716EJF	53000699EJF
Sand Dune	53000833ELV	53000830ELV
Smoky Gray & Black Hole	53000836EML	53000835EML
Sunset Orange Fade & Sunset Black with Lightning Silver (Road Glide/Street Glide)	53000836ERL	53000835ERL
Wicked Orange Pearl	53000653EUD	53000835EUD

Note: Check your local dealership for more information



'22 CVO BLUE STEEL KING TOUR-PAK



'22 CVO WICKED ORANGE PEARL KING TOUR-PAK



'22 CVO HIGHTAIL YELLOW PEARL KING TOUR-PAK



'22 CVO BLUE STEEL CHOPPED TOUR-PAK



'22 CVO WICKED ORANGE PEARL CHOPPED TOUR-PAK



'22 CVO HIGHTAIL YELLOW PEARL CHOPPED TOUR-PAK

COLOR SHOP 675

Color-Matched Accessories

A. SOFTAIL® QUARTER FAIRING

This street performance-inspired Quarter Fairing is designed to reduce drag while providing a sleek, custom look. With a Dark Smoke windscreen featuring a Harley-Davidson script on the lower leading edge, it provides the wind protection you need to go all day while looking sinister in the process.

Fits '18-later FXBB and FXLR, '20-later FXLRS, FXST and '21-later FXBBS models. Requires separate purchase of model specific Fairing Bracket Kit. FXBB models require separate purchase of Turn Signal Brackets P/N 12700164 and 67800630 and Hardware P/Ns 67015-02 (qty 2), 7155 (qty 1) and 7331 (qty 1). Does not fit FXBB or FXLR models equipped with Moto Bar P/Ns 55800856 or 55800858 when using Original Equipment handlebar risers. FXLR models equipped with Moto Bar P/Ns 55800856 or 55800858 and Tall Risers P/N 55800852 or 55800854 require separate purchase of Turn Signal Brackets P/N 12700164 and 67800630.

57001627	Raw.	\$336.95
57001615DH	Vivid Black.	\$532.95
57001615EKP	Billiard Blue.	\$560.95
57001615EKR	Barracuda Silver.	\$560.95
57001615EXE	Industrial Yellow.	\$509.95
57001615EVD	White Sand Pearl.	\$509.95
57001615ENR	Barracuda Silver Denim.	\$560.95
57001615EVC	Fastback Blue.	\$560.95
57001615EGZ	Gunship Gray.	\$560.95
57001615EUZ	Redline Red.	\$560.95
57001615ENT	River Rock Gray.	\$560.95
57001615ENX	Billiard Red.	\$560.95
57001615EOB	Stone Washed White Pearl.	\$560.95
57001615EOG	Spruce.	\$560.95

B. SOFTAIL QUARTER FAIRING BRACKET KIT

This matte black bracket kit is required for mounting the Quarter Fairing to your motorcycle.

57001249 **\$114.95**
Fits '18-later FXBB, FXLR and FXST. FXBB and FXST installation requires separate purchase of Turn Signal Brackets P/Ns, 12700164 and 67800630 and Hardware P/Ns 67015-02 (qty 2), 7155 (qty 1) and 7331 (qty 1). FXLR models with Tall Risers/Moto Bars require separate purchase of Turn Signal Brackets P/Ns 12700164 and 67800630 and Hardware P/N 67015-02 (qty 2).

57001250 **\$114.95**
Fits '20-later FXLRS models. Does not fit FXLRS models with Tall Risers and Moto Bars. Also compatible with 5.75" Headlight Bucket P/N 67700380, Trim Ring, Screw and Lock Nut P/N 67700375, 3383 and 7606.



A. SOFTAIL QUARTER FAIRING



B. SOFTAIL QUARTER FAIRING BRACKET KITS

Notice: The prices appearing in this catalog are the manufacturer's suggested retail prices. Actual retail prices may vary.

676 COLOR SHOP

Paints

A. PAINTS

Touch-up paint is available in handy 1/2-oz. applicator bottles for all late model Harley-Davidson® motorcycles including CVO™ models. Aerosol and quart containers are also available. See your Authorized Harley-Davidson® Dealer for a complete listing of paint.

NOTE: Quart containers of Harley-Davidson® Acrylic Urethane paint and urethane activator material are designed for application only by professional, trained personnel using proper equipment under controlled conditions and they are not intended for sale to the general public.

Black Texture

For use with '95-later Engine and Transmission.

98605BF*	Touch-Up Pen.	\$14.95
98600BF*	Touch-Up Bottle.	\$14.95
98606BF	Aerosol.	\$27.95

Silver Bead Blast

For use with '98-later Engine and Transmission.

98600BY*	Touch-Up Bottle.	\$14.95
98606BY	Aerosol.	\$27.95

Clear Coat

Used to fill in clear coating over chips and surface scratches.

98600EK*	Touch-Up Bottle.	\$14.95
98606EK	Aerosol.	\$27.95
98628EK	Quart. Two-Part Urethane.	\$93.95
99825-02	Urethane Activator.	\$61.95

Black Leather Touch-Up Pens

A convenient way to fix scratches, scuffed and worn pouches, saddlebags, seats and other leather products. Just touch-up the damaged area, wipe off excess, let dry and then buff with a soft cloth to blend color.

98605AX*		\$14.95
-----------------	--	----------------

Black Frame Paint Touch-up Pen

Dispensed from an easy-to-use paint pen, this paint is an easy way to touch-up minor nicks and scratches.

93936*		\$6.95
---------------	--	---------------

*NOTE: Price shown is price per each bottle or pen. There are two bottles or pens per package.



A. PAINTS

Notice: The prices appearing in this catalog are the manufacturer's suggested retail prices. Actual retail prices may vary.

COLOR SHOP 677

Medallions & Handlebar Gauges

B. FUEL CAP MEDALLIONS

Top off your Original Equipment fuel cap. Adhesive backing for easy installation.

Fits '83-later models (except VRSC™, XG, XL1200V, FXD, FXDX, FXR with plastic fuel cap, FLSTNSE, FXS, FXSB, FXSBSE, FXST-Aus, '18-later FXBB, FXBBS, FXDRS, FXFB, FXFBS, Electra Glide®, Road Glide®, Tour Glide™, Tri Glide®, '15-later XL883N, '04-'10 XL1200L and XL1200C, '08-later XR, '05-'06 FXDC and all fuel caps with gauges or locks).

14101220	Ride Free.	\$31.95
99688-10	Dark Custom.	\$23.95
99670-04	Willie G Skull.	\$23.95
99539-97	H-D Motor Co.	\$20.95
99020-90T	Live to Ride.	\$30.95
99669-04	Willie G Skull.	\$23.95

Fits '04-'10 XL883C, XL1200C and XL1200L models.

C HANDLEBAR MOUNT CLAMP

Position your Handlebar Clock or Temperature Gauge for quick and comfortable viewing. Custom hinged clamp firmly grips the handlebar and locks the clock or temperature gauge into position. Easy to install at your choice of location along the bar, this clamp provides an alternative mounting position if the handlebar control clamp bracket is occupied by other accessories like zūmo® GPS Navigator, Boom!™ Audio Cruiser Amp & Speaker Kit, Gear Indicators or Auxiliary Switch Housings.

Fits all models with 1" handlebars.

10800057	1.0" Black.	\$25.95
-----------------	-------------	----------------

Fits all models with 1.25" handlebars.

10800056	1.25" Chrome.	\$27.95
10800058	1.25" Black.	\$27.95



B. FUEL CAP MEDALLION – RIDE FREE



B. FUEL CAP MEDALLION – DARK CUSTOM LOGO



B. FUEL CAP MEDALLIONS – WILLIE G SKULL



B. FUEL CAP MEDALLION – H-D MOTOR CO.



B. FUEL CAP MEDALLION – GOLD LIVE TO RIDE



C. HANDLEBAR MOUNT CLAMP – CHROME

Model Family Fitment:

■ V-ROD	■ SPORTSTER	■ DYNA
■ SOFTAIL	■ TOURING	

Notice: The prices appearing in this catalog are the manufacturer's suggested retail prices. Actual retail prices may vary.

COLOR SHOP

678 COLOR SHOP

Medallions & Decals

A. FUEL TANK NAMEPLATE AND ADAPTER KITS

For those of you with nostalgia in mind, our popular fuel tank trims fit a wide selection of early models. In addition, we now offer adapter kits for later models. The adapter kits come with all necessary hardware for installation of fuel tank trim on later models. Adapter Kit Brackets are self-adhesive to accommodate most universal applications. Due to fuel tank shape variability, test fit relevant adapter plate to desired fuel tank to ensure full surface contact before adhering to tank. All trim and adapter kits are sold in pairs.

1. 61769-47T Fits all '47-'50 models. **\$47.95**

Adapter Kit for P/N 61769-47T

61783-92T **\$27.95**
Fits '84-'17 Fat Bob® fuel tanks (except '08-later Touring and Trike models).

2. 61776-61T Fits '61-'62 FL models. **\$53.95**

Adapter Kit for P/N 61776-61T

61740-90T **\$27.95**
Fits Fat Bob fuel tanks (except '08-later Touring and Trike models).

3. 61775-59T Fits '59-'60 FL models. **\$47.95**

Adapter Kit for P/N 61775-59T

61742-93T **\$27.95**
Fits '84-'17 Fat Bob® fuel tanks (except '08-later Touring and Trike models).

4. 61769-40T Fits '36-'46 Big Twin models. **\$47.95**

Adapter Kit for P/N 61769-40T

61785-92T **\$27.95**
Fits '84-'17 Fat Bob® fuel tanks (except '08-later Touring and Trike models).

5. 61774-51T **\$47.95**
Fits '51-'54 Big Twin and '52-'54 K models.

Adapter Kit for P/N 61774-51T

61784-92T **\$27.95**
Fits '84-'17 Fat Bob® fuel tanks (except '08-later Touring and Trike models).

6. 61814-55T Chrome. **\$47.95**
Fits '55-'56 FL models.

Adapter Kit for P/N 61814-55T

61840-94T **\$27.95**
Fits Fat Bob fuel tanks (except '08-later Touring and Trike models).

B. DECORATIVE MEDALLIONS

1. 14101831 Willie G. Skull. **\$36.95**

2. 14101832 Bar & Shield. **\$31.95**

3. 14101833 #1 Logo. **\$31.95**

4. 14101834 Harley-Davidson. **\$31.95**

5. 14101835 Gold. **\$31.95**
Winged Bar & Shield Medallion

6. 14101836 Chrome. **\$36.95**
Winged Bar & Shield Medallion



A. FUEL TANK NAMEPLATE AND ADAPTER KITS

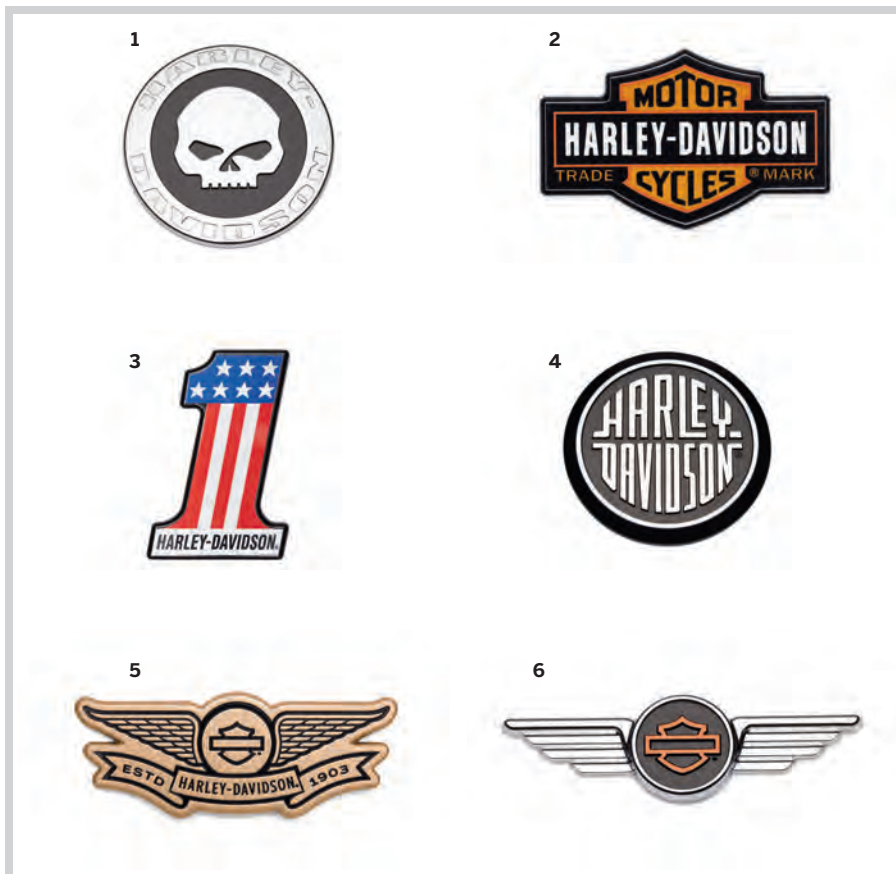

B. DECORATIVE MEDALLIONS



C. DECORATIVE MEDALLIONS



D. SELF-ADHESIVE MEDALLIONS AND SISSY BAR UPRIGHT INSERTS



E. LIVE TO RIDE LOGO MEDALLIONS - CHROME AND GOLD



F. METAL ADHESIVE-BACKED LOGO



G. RIDE FREE MEDALLION - LARGE



G. RIDE FREE MEDALLION - SMALL

COLOR SHOP 679

Medallions & Decals

C. DECORATIVE MEDALLIONS

Display a touch of attitude. Ideal for use on plate-style sissy bar uprights and battery covers, the adhesive backing on these high-quality cast medallions allows easy installation on most flat surfaces. The medallions are available in black accented chrome or antique nickel finishes. The Oval Bar & Shield logo and the Bar & Shield with Wings medallions look great with Chrome Backrest Mount P/N 52527-01 and 52531-01.

1. Skull - Chrome
91718-02 3-5/8" x 3". **\$31.95**

2. Skull with Wings - Chrome
91723-02 5" x 1-1/2". **\$31.95**

3. Bar & Shield Logo with Wings - Chrome
91745-02 4" x 1-1/2". **\$23.95**

D. SELF-ADHESIVE MEDALLIONS AND SISSY BAR UPRIGHT INSERTS

Works great on derby covers, timer covers, medallion plate-style sissy bar uprights and chrome battery covers.

Made In U.S.A. Eagle

1. 99000-77 Large Medallion. **\$29.95**

Bar & Shield Logo
2. 91815-85 Large Medallion. **\$31.95**

Eagle with Bar & Shield Logo
3. 91811-85 Large Medallion. **\$31.95**

E. LIVE TO RIDE LOGO MEDALLIONS

These self-adhesive medallions are made of durable ABS plastic, and look great on sissy bars, battery covers, Tour-Pak® luggage carriers, saddlebags, etc.

99027-90T 3.5" - Gold. **\$29.95**

F. METAL ADHESIVE-BACKED LOGO

All you do is choose the style you like, select a Timer or Derby Cover and affix the medallion to the cover. Works great on medallion, plate-style sissy bar uprights and chrome battery covers.

99352-82Z Bar & Shield Logo. Universal. **\$14.95**

G. RIDE FREE™ COLLECTION MEDALLION

This collection celebrates our liberty to enjoy the freedom of the open road, and calls us all to explore, discover and unite with our love of motorcycling. Inspired by Willie G. Davidson's famous phrase, this collection continues in this tradition. These self-adhesive medallions make it easy to add some finishing touches to your motorcycle. Celebrating the freedom of the open road, the easy-to-apply medallions are drenched in wrinkle black and accented by brilliant chrome for a modern twist on classic style.

Universal Fitment.

14101218 Large. **\$38.95**

14101219 Small. **\$28.95**



Indoor/Outdoor Motorcycle Cover

HARLEY-DAVIDSON®

GARAGE

The exceptional deserves to be treated exceptionally. Show your ride some TLC with cleaning and service supplies created by the only people who know and love your motorcycle as much as you — the experts at Harley-Davidson.

BODYGUARD IN A BOTTLE

Oil is the lifeblood of your engine. It not only lubricates the moving parts, but also cools, cleans and flushes away all the byproducts of combustion. It lives in an environment filled with heat, friction and toxins that are determined to break it down and shorten its useful life. And it keeps the heart of your motorcycle beating at idle or at full throttle. Harley-Davidson's complete line of lubricants are formulated specifically to keep your motorcycle running strong, mile after mile.



ENGINE OIL FAQ

What's in a bottle of oil?

- The Base Stock makes up 75-80% of a bottle of oil. Generally, if it comes from the ground, it is a Mineral Oil. And if it is made in a lab or a reactor, it is Synthetic Oil.
- The Additive Pack makes up the remaining 20-25%. These are the ingredients that make oil smarter and tailored to its application. The additives include:
 - Viscosity Modifiers – lets oil flow like 20 weight oil at start-up and 50 weight oil at operating temperatures
 - Detergents – cleans inside your engine
 - Dispersants – suspends contaminants in the oil so they can be carried to the filter
 - Buffers – neutralizes acids that form in your engine
 - Anti-oxidants – prevents sludge and oil thickening oxidation
 - Corrosion inhibitors – protects internal components from corroding
 - Anti-wear additives – provides protection against internal wear

How often should I change my motorcycle engine oil?

You should change your motorcycle engine oil and engine oil filter at the first 1,000-mile service interval and at every 5,000-mile service interval thereafter. If you ride your motorcycle hard, under dusty conditions or in cold weather, the engine oil and filter should be changed more often. You should always change your engine oil and filter prior to winter storage (or any extended storage) so that your engine oil is clean and free of contaminants during this time period.

What viscosity grade should I use in my Harley® Motorcycle?

The recommended viscosity grade for all temperature conditions is SAE 20W50 Harley-Davidson® Motor Oil. The SAE 50 H-D® Motorcycle Oil is satisfactory in ambient temperatures of 60-80°F, and the SAE 60 H-D® Motorcycle Oil in ambient temperatures above 80°F. SAE 20W50 covers the broadest range of operating temperatures.

What's the difference between synthetic and petroleum-based lubricants?

Group I, II and III petroleum-based lubricants are derived from oil pumped from the ground. Group IV and V synthetic lubricants are chemically produced in a lab. Petroleum-based lubricants inherit physical components (including contaminants) of the source crude oil in the refining process, while synthetic lubricants are custom-formulated to have desired properties for specific purposes, meaning that engineers have complete control of the lubricant from start to finish – at the molecular level.

What's better in my bike – Petroleum or Synthetic?

Petroleum lubricants have been around for a long time, and are effective at lubricating in most conditions, but mineral oil can't compete with the purity of synthetic lubricants – especially in extreme conditions. Synthetic oil does a better job reducing wear and resisting breakdown under a wider range of operating temperatures.

What does SYN3® full Synthetic Motorcycle Lubricant do for my drivetrain?

SYN3® Full Synthetic Motorcycle Lubricant offers all the benefits of Genuine Harley-Davidson® Motorcycle Oil, and:

- Offers superior wear protection at higher temperatures
- Keeps engines, transmissions and primary chaincases cleaner
- Meets the anti-wear lubricity requirements of all transmission gears
- Lubricates all primary chaincase components
- Delivers smooth, sure clutch operation
- Provides long-term protection of all internal components
- Improves seal and gasket performance
- Offers superior performance in high-output engines

What makes Harley® SYN3 better than other Synthetics for my Harley motorcycle?

- SYN3 is pure, genuine, full synthetic lubricant.
- SYN3 base stocks are synthesized materials – including Poly Alfa Olefin (PAO) and Esther, which are the most pure, highest quality synthetic base stocks available
- SYN3 has the smartest, most robust additive package developed specifically to provide maximum performance and protection in H-D® powertrains

Beware, not all synthetics are created equal.

- Due to a legal loophole, other brands are selling Highly Refined Group III mineral oil as synthetic oil
 - Head to head, SYN3 outperforms these oils
- SYN3 is a product you can trust, from a brand you can trust. Oil is the lifeblood to your Harley-Davidson; don't take chances with anything else.

Why should I use H-D™ oil in my Harley?

- No one tests as much as we do – we test on the road, on dynos and in the laboratory
 - We accumulate millions of testing miles on our engines and drive trains, using only H-D Oil
 - We test in the harshest environments – testing is performed in the extreme heat of the desert
 - We test under the most rigorous duty cycles – accelerated durability testing helps explore the limits of our designs, in less time. This is a worst case scenario for oil
 - We run thousands of hours on dynos
 - We test in the laboratory – sampling and analyzing oil to determine its life and effectiveness during use
- H-D's additive package is the best available, it's the most robust, it was created exclusively for H-D powertrains and we are the only ones who have it.

A. SCREAMIN' EAGLE® SYN3® FULL SYNTHETIC MOTORCYCLE LUBRICANT

TESTED-CERTIFIED for use in Harley-Davidson® engine, primary chaincase and transmission applications, Screamin' Eagle® SYN3® Full Synthetic Lubricant makes changing and topping off fluids a simple, one-product process. Developed with a proprietary three synthetic basestock formula, Screamin' Eagle SYN3 Lubricant is formulated to provide for long-term protection and engine cleanliness requirements, and to provide superior high-temperature protection for high-output engines. SYN3 Lubricant is formulated to maintain the coefficient of friction for proper clutch operation and to provide the proper lubrication to the primary chain drive. In addition, SYN3 Lubricant is designed to provide the correct lubricity for the anti-wear requirements of transmission gears and for improved seal protection. This formula is approved by Harley-Davidson for use in all stages of engine life and is not detrimental to the break-in stage of engines.

Formulated for use in Harley-Davidson® Engines, Transmissions and the following Primary Chaincase applications: '71-later XL, '83-'84 XR1000, '08-'13 XR, and '84-later FX, FXR, Dyna®, Softail®, Revolution® Max equipped models, Touring and Trike models.

United States

62600005	SAE 20W50 – 1 Quart.	\$16.49
62600031A	SAE 20W50 – 1 Gallon.	\$64.95

Canada

62600011	SAE 20W50 – 1 Liter.	\$16.49
62600030A	SAE 20W50 – 4 Liter.	\$64.95

Europe/Latin America

62600015	SAE 20W50 – 1 Liter.	\$16.49
-----------------	----------------------	----------------

Asia/Pacific

62600021	SAE 20W50 – 1 Quart.	\$16.49
-----------------	----------------------	----------------



A. SCREAMIN' EAGLE SYN3 FULL SYNTHETIC MOTORCYCLE LUBRICANT

B. H-D® GENUINE SYN BLEND MOTORCYCLE OIL

Genuine SYN Blend Motorcycle Oil is a formulation engineered by Harley-Davidson® and factory tested for optimal performance. This oil blends premium base stocks with premium Harley-Davidson® proprietary additives for: Optimized durability. Minimal friction loss. Wide ambient operating temperature. Superior durability for engine components over a wide operating range and temperature. Supports tighter engine tolerances in colder temperatures. Formulated for optimal clutch, engine, and transmission performance. Facilitates long life of emission components, including exhaust catalysts.

Fits '21-later Revolution Max equipped models

62600099	Quart, US.	\$13.95
62600102	Quart, Asia Pacific.	\$13.95
62600101	Litre, Europe/South America.	\$13.95
62600100	Litre, Canada.	\$13.95



B. H-D® GENUINE SYN BLEND MOTORCYCLE OIL

Notice: The prices appearing in this catalog are the manufacturer's suggested retail prices. Actual retail prices may vary.

684 GARAGE

Oil & Lube

A. HARLEY-DAVIDSON GENUINE MOTORCYCLE OIL

Harley-Davidson® Genuine Motorcycle Oil is developed and tested for use in Harley-Davidson® motorcycles. Our unique additive package helps prevent engine wear and helps keep your engine cooler, cleaner and free of sludge, varnish and corrosion.

Harley-Davidson air-cooled V-Twin motorcycles operate at higher temperatures than water-cooled engines, thus a specific high temperature additive package is necessary to protect the engine. Be assured, H-D Genuine Motorcycle Oil can be trusted in a Harley-Davidson® engine.

Available in SAE 20W50, SAE 50, and SAE 60. Refer to your Harley-Davidson owner's manual for the proper SAE grade recommendation based on the climate and temperature range you ride in.

United States

62600007	SAE 20W50 – 1 Quart.	\$10.49
62600038A	SAE 20W50 – 1 Gallon.	\$41.95
62600008	SAE 50 – 1 Quart.	\$10.49
62600009	SAE 60 – 1 Quart.	\$10.49

Canada

62600013	SAE 20W50 – 1 Liter.	\$10.49
62600041A	SAE 20W50 – 4 Liter.	\$41.95
62600014	SAE 50 – 1 Liter.	\$10.49

Europe/Latin America

62600017	SAE 20W50 – 1 Liter.	\$10.49
62600042A	SAE 20W50 – 4 Liter.	\$41.95
62600018	SAE 50 – 1 Liter.	\$10.49

Asia/Pacific

62600023	SAE 20W50 – 1 Quart.	\$10.49
62600043A	SAE 20W50 – 1 Gallon.	\$41.95
62600024	SAE 50 – 1 Quart.	\$10.49
62600060	SAE 60 – 1 Quart.	\$10.49



A. HARLEY-DAVIDSON GENUINE MOTORCYCLE OIL

B. OIL CHANGE KITS

Everything you need for a complete engine oil and filter change. Select Harley-Davidson approved Screamin' Eagle® SYN3® Synthetic Lubricant or H-D Genuine Motorcycle Oil 20W50 and choose a black or chrome SuperPremium 5-micron oil filter. Package includes Oil, Oil Filter and replacement O-Ring.

SYN3 – SAE 20W50

Fits '99-later Twin Cam and Sportster® Evolution® models (except '08-'13 XR) and can be used as an upgrade for any models that requires Oil Filter P/N 63796-77A, 63805-80A, 63812-90 or 63813-90.

62600082	4 Quarts + Chrome Oil Filter.	\$91.95
62600083	4 Quarts + Black Oil Filter.	\$89.95

Fits '17-later Milwaukee-Eight® engine equipped models.

62600085A	5 Quarts + Chrome Oil Filter.	\$108.95
62600084A	5 Quarts + Black Oil Filter.	\$105.95

Fits '21-later Revolution Max models.

62600112	4 Quarts + Black Oil Filter.	\$87.95
-----------------	------------------------------	----------------

HARLEY-DAVIDSON® GENUINE SYN BLEND MOTORCYCLE OIL – 4 QUART OIL CHANGE KIT

Genuine SYN Blend Motorcycle Oil is a formulation engineered by Harley-Davidson® and factory tested for optimal performance. This oil blends premium base stocks with premium Harley-Davidson® proprietary additives.

Fits '21-later Revolution® Max equipped models.

62600111	4 Quarts + Black Oil Filter.	\$76.95
-----------------	------------------------------	----------------

H-D GENUINE MOTORCYCLE OIL SAE 20W50

Fits '99-later Twin Cam and Sportster Evolution models (except '08-'13 XR) and can be used as an upgrade for any models that requires Oil Filter P/N 63796-77A, 63805-80A, 63812-90 or 63813-90.

62600087	4 Quarts + Chrome Oil Filter.	\$66.95
62600088	4 Quarts + Black Oil Filter.	\$64.95

Fits '17-later Milwaukee-Eight engine equipped models.

62600089A	5 Quarts + Chrome Oil Filter.	\$77.95
62600090A	5 Quarts + Black Oil Filter.	\$74.95



B. OIL CHANGE KITS – SYN3 – SAE 20W50 CHROME



B. OIL CHANGE KITS – SYN3 – SAE 20W50 BLACK



B. OIL CHANGE KITS – H-D GENUINE - SAE 20W50 – CHROME



B. OIL CHANGE KITS - H-D GENUINE - SAE 20W50 - BLACK

GARAGE 685

Oil & Lube

C. HEAVY SYNTHETIC GEAR OIL

TESTED-CERTIFIED for use in Harley-Davidson® transmission and primary chaincase applications. Exclusively engineered for Harley-Davidson® motorcycles, this Heavy Synthetic Gear Oil is intended for use in extreme temperature environments (desert heat or cold weather), frequent two-up riding and heavy load riding applications. This dual viscosity (SAE 80W-140), heavy weight gear and primary oil was developed with proprietary additives and pure synthetic base stock so it flows better at cold start-up than in high temperatures viscosity behaves like a 140 weight oil to provide maximum protection. Formulated to maintain the proper coefficient of friction for clutch operation and to provide superior lubrication for the primary chain drive. This Gear Oil was formulated to provide specialized lubricity for the anti-wear requirements of transmission gears across a wider temperature range than mineral based oil. This Heavy Synthetic Gear Oil is approved by Harley-Davidson for use in all stages of transmission and primary chaincase life. This is not for use in the crankcase as a motor oil.

Formulated for use in all H-D® Transmissions and the following primary chaincase applications: '71-later XL, '83-'84 XR1000, '08-'13 XR, and '84-later Big Twin models with wet-type diaphragm spring clutch. Not for use in '02-'17 VRSC™ or '15-later XG models.

62600091	For U.S. markets.	\$21.95
62600092	For Canada.	\$21.95
62600093	For Europe and Latin America markets.	\$21.95
62600094	For Asia/Pacific markets.	\$21.95

D. FORMULA+ TRANSMISSION AND PRIMARY CHAINCASE LUBRICANT

Developed with a proprietary mineral basestock formula and TESTED-CERTIFIED by Harley-Davidson Motor Company, Formula+ is blended to provide lubricity for the anti-wear requirements of transmission gears. Formulated to maintain the coefficient of friction for proper clutch operation and provide adequate lubrication to the primary chain, this lubricant is approved for use in all stages of transmission and primary chaincase life. Not for use in the crankcase as a motor oil.

TESTED-CERTIFIED Extended Service intervals:

Primary Chaincase

'84-later Big Twin models with wet-type diaphragm spring clutch. Every 10,000 miles, or prior to winter or extended storage periods.

Transmission

All Big Twin models. Every 20,000 miles, or prior to winter or extended storage periods.

Primary/Transmission

'71-later XL and '83-'84 XR1000 models. Every 10,000 miles, or prior to winter or extended storage periods.

Formulated for use in Harley-Davidson Transmissions and the following Primary Chaincase applications: '71-later XL, '83-'84 XR1000, '08-'13 XR, and '84-later FX, FXR, Dyna®, Softail®, Touring and Trike models with wet type diaphragm spring clutch. Not for use in '02-later VRSC™ or '15-later XG models.

62600004	1 Quart – U.S.	\$11.95
62600010	1 Liter – Canada.	\$11.95
62600019	1 Liter – Europe.	\$11.95
62600033	1 Quart – Asia/Pacific.	\$11.95



C. HEAVY SYNTHETIC GEAR OIL



D. FORMULA+ TRANSMISSION AND PRIMARY CHAINCASE LUBRICANT

Notice: The prices appearing in this catalog are the manufacturer's suggested retail prices. Actual retail prices may vary.

Notice: The prices appearing in this catalog are the manufacturer's suggested retail prices. Actual retail prices may vary.

686 GARAGE

Tune Up Kits

HARLEY-DAVIDSON® TUNE UP KITS

Do it yourself and do it right with a Harley-Davidson® Tune Up Kit for Sportster®, Twin Cam or Milwaukee-Eight® engines. Each box is packed with Genuine Motor Parts, including spark plugs, oil filter, oil and primary lube and required gaskets. Easy to buy. Easy to store on the garage shelf. A tune up was never so easy.

A. MILWAUKEE-EIGHT® SYN3™ TUNE UP KIT

Do it right with Genuine Motor Parts. Each Tune Up Kit packs everything you need for a DIY service interval in a single box that's easy to buy and easy to store.

Kit contains:

- 5 quarts Genuine SYN3® oil
- SuperPremium 5-micron oil filter
- 2 quarts Harley-Davidson® Heavy Synthetic Gear Oil
- Service gasket kit
- 4 spark plugs

Fits '17-later Milwaukee-Eight engine-equipped models.

62600123	BlackFilter.	\$176.95
62600128	Chrome Filter.	\$179.95



A. MILWAUKEE-EIGHT – SYN3™ TUNE UP KIT BLACK



A. MILWAUKEE-EIGHT – SYN3™ TUNE UP KIT CHROME



D. TWIN CAM SYN3 TUNE UP KIT – BLACK



D. TWIN CAM SYN3 TUNE UP KIT – CHROME

B. MILWAUKEE-EIGHT® 20W50/FORMULA+ TUNE UP KIT

Do it right with Genuine Motor Parts. Each Tune Up Kit packs everything you need for a DIY service interval in a single box that's easy to buy and easy to store.

Kit contains:

- 5 quarts H-D Genuine Motorcycle oil 20W50
- SuperPremium 5-micron oil filter
- 2 quarts Formula+ Transmission and Primary Chaincase Lubricant
- Service gasket kit
- 4 spark plugs

Fits '17-later Milwaukee-Eight engine-equipped models.

62600131	BlackFilter.	\$126.95
62600132	Chrome Filter.	\$129.95



B. MILWAUKEE-EIGHT – 20W50/FORMULA+ TUNE UP KIT – BLACK



B. MILWAUKEE-EIGHT – 20W50/FORMULA+ TUNE UP KIT – CHROME

C. TWIN CAM 20W50/FORMULA+ TUNE UP KIT

Do it right with Genuine Motor Parts. Each Tune Up Kit packs everything you need for a DIY service interval in a single box that's easy to buy and easy to store.

Kit contains:

- 5 quarts H-D Genuine Motorcycle oil 20W50
- SuperPremium 5-micron oil filter
- 2 quarts Formula+ Transmission and Primary Chaincase Lubricant
- Service gasket kit
- 2 spark plugs

Fits '99-'18 Twin Cam models.

62600141	BlackFilter.	\$117.95
62600140	Chrome Filter.	\$120.95



C. TWIN CAM™ 20W50/FORMULA+ TUNE UP KIT – BLACK



C. TWIN CAM™ 20W50/FORMULA+ TUNE UP KIT – CHROME



E. XL SYN3 TUNE UP KIT – BLACK



E. XL SYN3 TUNE UP KIT – CHROME



F. XL 20W50/FORMULA+ TUNE UP KIT – BLACK



F. XL 20W50/FORMULA+ TUNE UP KIT – CHROME

GARAGE 687

Tune Up Kits

D. TWIN CAM SYN3™ TUNE UP KIT

Do it right with Genuine Motor Parts. Each Tune Up Kit packs everything you need for a DIY service interval in a single box that's easy to buy and easy to store.

Kit contains:

- 5 quarts Genuine SYN3® oil
- SuperPremium 5-micron oil filter
- 2 quarts Harley-Davidson® Heavy Synthetic Gear Oil
- Service gasket kit
- 2 spark plugs

Fits '99-'18 Twin Cam models.

62600139	BlackFilter.	\$167.95
62600138	Chrome Filter.	\$170.95

E. XL SYN3 TUNE UP KIT

Do it right with Genuine Motor Parts. Each Tune Up Kit packs everything you need for a DIY service interval in a single box that's easy to buy and easy to store.

Kit contains:

- 3 quarts Genuine SYN3® oil
- SuperPremium 5-micron oil filter
- 1 quart Harley-Davidson® Heavy Synthetic Gear Oil
- Required gasket and O ring
- 2 spark plugs

Fits '04-'22 Sportster models.

62600136	BlackFilter.	\$106.95
62600137	Chrome Filter.	\$107.95

F. XL 20W50/FORMULA+ TUNE UP KIT

Do it right with Genuine Motor Parts. Each Tune Up Kit packs everything you need for a DIY service interval in a single box that's easy to buy and easy to store.

Kit contains:

- 3 quarts Harley-Davidson Genuine Motorcycle oil
- SuperPremium 5-micron oil filter
- 1 quart Formula+ Transmission and Primary Chaincase Lubricant
- Required gasket and O ring
- 2 spark plugs

Fits '04-'22 Sportster models.

62600135	BlackFilter.	\$78.95
62600134	Chrome Filter.	\$79.95

Notice: The prices appearing in this catalog are the manufacturer's suggested retail prices. Actual retail prices may vary.

Notice: The prices appearing in this catalog are the manufacturer's suggested retail prices. Actual retail prices may vary.

688 GARAGE

Oil Filters

A. SUPERPREMIUM5™ OIL FILTERS – 5 MICRON

Utilizing advances in synthetic media technology, the SuperPremium5™ Oil Filters are Tested-Certified to provide filtration to retain dust, soot and other solid matter with low internal pressure drop. Filter also includes internal pressure relief and anti-drain back valves.

Fits '17-later Milwaukee-Eight® equipped models only.

62700297	Chrome.	\$18.95
62700296	Black.	\$15.95

Fits '99-'17 Twin Cam and '99-later Evolution® equipped models (except '08-'13 XR) and can be used as an upgrade for any motorcycle that requires Oil Filter P/N 63796-77A, 63805-80A, 63812-90 or 63813-90.

63798-99A	Chrome.	\$18.95
63731-99A	Black.	\$15.95

SuperPremium10 Oil Filter – 10 Micron (not shown)

Fits '02-'17 VRSC™ models.

63793-01K	Black.	\$12.95
------------------	--------	----------------

B. GENUINE HARLEY-DAVIDSON® OIL FILTERS

Filter features cured resin impregnated paper, which removes harmful foreign particles from the oil. End caps and thermal setting adhesive provide positive seals, preventing bypassing of contaminant-laden oil.

Fits all XB and Buell™ models.

63806-00Y	Black.	\$12.95
------------------	--------	----------------

Fits '15-later XG models.

62700045		\$12.95
-----------------	--	----------------

Fits '91-98 Dyna® models.

63813-90	Chrome, Extra Long.	\$15.95
-----------------	---------------------	----------------

Fits late '82-'84 FLH-80 Classics, '82-'86 FXWG, FXSB, FXEF and '79-early '84 XL models.

63810-80A	Black, Short.	\$12.95
------------------	---------------	----------------

Fits '84-later XL, '08-'13 XR, '82-'94 FXR, '84-'98 Softail® and '80-'98 FLHR, FLHT and FLT models.

63796-77A	Chrome, Long.	\$13.95
------------------	---------------	----------------

63805-80A	Black, Long.	\$12.95
------------------	--------------	----------------

CLASSIC MOTOR PARTS OIL FILTERS (not shown)

Quality filters at a great price. Replaces P/N 63840-53 or 63835-87T with a cartridge type filter and spring.

62700055	In Tank Oil Filter.	\$13.95
-----------------	---------------------	----------------

C. LOW PROFILE OIL DRAIN PAN

Reduce the mess and cleanup required when changing the fluids on your motorcycle. This reusable Drain Pan is designed specifically for use with Harley-Davidson® motorcycles. The low-profile design fits easily under standard height and lowered motorcycles, and slips beneath the bike even when on the side stand. The 10-quart capacity pan will capture 2 engine oil changes, or the complete drain fluids (engine oil, primary and transmission) from any H-D® Powertrain, including Milwaukee-Eight and Twin Cam motorcycle. The Drain Pan is large enough to catch the oil from the entire length of the primary, and is sized to hold and drain an inverted primary cover. The Drain Pan features a raised hardware corral, a filter drain surface and a pressure vent hole to prevent messy oil burping. The drained waste oil is sealed safely inside the pan with high-quality gasketed caps and plugs. Convenient carrying handle simplifies transport to an approved waste oil facility.

63795-10	10-Quart Capacity.	\$34.95
-----------------	--------------------	----------------



A. SUPERPREMIUM5 OIL FILTERS



B. GENUINE HARLEY-DAVIDSON OIL FILTERS



C. LOW PROFILE OIL DRAIN PAN



D. OIL FILTER WRENCH – END CAP STYLE



F. OIL CATCHER DRAIN OIL FUNNEL



H. ROAD FUNNEL



E. OIL FILTER REMOVAL WRENCH



G. PRIMARY OIL FILL FUNNEL



I. TRANSMISSION/CRANKCASE FILL FUNNEL

GARAGE 689

Oil Change Accessories

D. OIL FILTER WRENCH – END CAP STYLE

Simplify oil filter removal and installation with this convenient End Cap Style Filter Wrench. The wrench grips the filter without crushing the canister, and allows the spin-on filter to be turned with a 3/8 drive socket wrench.

14900138		\$16.95
-----------------	--	----------------

Fits '21-later Revolution® Max equipped models.

94863-10		\$13.95
-----------------	--	----------------

For use with H-D® spin-on oil filters (except '15-later XG, '21-later RA1250 and RA1250S models).

14900091		\$17.95
-----------------	--	----------------

For use with H-D spin-on oil filters for '15-later XG models.

E. OIL FILTER REMOVAL WRENCH

This slip-resistant wrench, featuring a stainless steel band, is designed to make the removal of your oil filter much easier.

94866-00		\$13.95
-----------------	--	----------------

For use with H-D® spin-on oil filters (except '15-later XG, '21-later RA1250 and RA1250S models).

F. OIL CATCHER DRAIN FUNNEL

Reduce oil drips when removing the oil filter. The Oil Catcher Funnel slips below the filter, and provides access to spin the filter off its mount. Oil is captured in the funnel, and is siphoned into a bottle or catch basin through the drain tube. Smooth orange plastic surface is easy to clean after use.

63794-10		\$23.95
-----------------	--	----------------

Fits '04-later XL, '08-'13 XR, '99-'17 Dyna®, '99-'16 Touring and '09-'16 Trike models.

62700199		\$26.95
-----------------	--	----------------

Fits '17-later Milwaukee-Eight® engine equipped models.

G. PRIMARY OIL FILL FUNNEL

This reusable funnel makes it easy to add oil to your primary cavity. The funnel simply snaps into the derby cover opening to permit hands-free filling on the specified models. The convenient tab allows you to place the funnel in position with one hand, and the flat cone shape makes it easy to fill a tight area with no mess or spills. Smooth orange plastic surface is easy to clean after use.

62700239		\$13.95
-----------------	--	----------------

Fits '18-later FL5B and '19-later Softail® models.

63797-10		\$13.95
-----------------	--	----------------

Fits '06-'17 Dyna®, '07-'18 Softail (except '18 FL5B), and '07-later Touring and Trike models.

62700015		\$12.95
-----------------	--	----------------

Fits '84-'00 Evolution® 1340-equipped models, '99-'05 Dyna, '00-'06 Softail and '99-'06 Touring Twin Cam-equipped models.

H. ROAD FUNNEL

This disposable folding funnel can be taken on the road and used for those times you need to replenish your bike's fluids. The funnel fits easily into your luggage, does not take up valuable storage space and can be thrown away after use. Convenient tear-off 3-pack means you will always be prepared.

97410-10		\$2.95
-----------------	--	---------------

I. TRANSMISSION/CRANKCASE FILL FUNNEL

Fill your transmission and crankcase without the mess. This funnel is shaped to fit into tight spaces, and is designed to reach even the toughest access points. The anti-burp design ensures smooth oil flow, and the smooth orange plastic surface is easy to clean after use.

63799-10A		\$6.95
------------------	--	---------------

Notice: The prices appearing in this catalog are the manufacturer's suggested retail prices. Actual retail prices may vary.

Notice: The prices appearing in this catalog are the manufacturer's suggested retail prices. Actual retail prices may vary.

690 GARAGE

Oil & Lube

A. H-D® FORK OIL

Refer to Owner's Manual for required type.

62600025	Type B. 16 fl oz (473 ml) Bottle.	\$8.95
62600098	Type D. 16 fl oz (473 ml) Bottle.	\$21.95
62600026	Type E. 16 fl oz (473 ml) Bottle.	\$8.95

B. SCREAMIN' EAGLE® PERFORMANCE FORK OIL

A heavier blended oil that provides extra damping in performance applications.

62600027	16 fl oz (473 ml) Bottle.	\$8.95
-----------------	---------------------------	---------------

Also available:

H-D FORK SEAL GREASE (not shown)

Required for service of fork seals.

11300005	1 oz (28 g) Tube.	\$14.95
-----------------	-------------------	----------------

C. H-D GENUINE EXTENDED LIFE ANTIFREEZE AND COOLANT

Antifreeze is pre-diluted with deionized water to eliminate cooling system contamination. Formulated to use at full strength (do not add water), this coolant provides exceptional heat transfer properties. Protects the entire cooling system against corrosion. Formula is silicate-free, phosphate-free, nitrate-free and borate-free.

For use in VRSC, XG, and models equipped with Twin-Cooled™ engines.

26800191	1 Quart US.	\$22.95
26800188	1 Liter International.	\$22.95

D. H-D DOT 5 BRAKE FLUID

For use in all models (except '06-later VRSC™, '07-later XL, '08-later XR, '06-later Dyna® and Softail® and '05-later Touring and Trike models).

41800220	12 fl oz (355 ml) Bottle.	\$15.95
-----------------	---------------------------	----------------

E. PLATINUM LABEL DOT 4 BRAKE FLUID

For use in '20-later EV '06-'17 VRSC, '15-later XG, '07-later XL, '08-later XR, '06-'17 Dyna and '06-later Softail, and '05-later Touring and Trike models.

41800770	Platinum Label Dot 4 (English, Spanish)	\$8.95
41800771	Platinum Label Dot 4 CAN (English, French Canadian)	\$8.95
41800772	Platinum Label Dot 4 APC (English, Japanese, Simplified Chinese, Thai, Bahasa, Burmese, French, Malay, Vietnamese, Korean, Traditional Chinese)	\$8.95
41800773	Platinum Label Dot 4 Central EU (English, German, Czech, Slovak, Hungarian, Romanian, Polish, Slovenian, Croatian)	\$8.95
41800774	Platinum Label Dot 4 (English, Russian)	\$8.95
41800822	Platinum Label Dot 4 North EU (English, Dutch, Swedish, Norwegian, Finnish, Danish, Estonian, Lithuanian)	\$8.95
41800823	Platinum Label Dot 4 EMEA, LA (English, Italian, French, Arabic, Spanish, Portuguese, Greek, Turkish, Hebrew, Bulgarian)	\$8.95



A. H-D FORK OIL



B. SCREAMIN' EAGLE PERFORMANCE FORK OIL



C. H-D GENUINE EXTENDED LIFE ANTIFREEZE AND COOLANT



D. H-D DOT 5 BRAKE FLUID



E. PLATINUM LABEL DOT 4 BRAKE FLUID



F. H-D ETHANOL GUARD FUEL STABILIZER



H. HARLEY LUBE



J. H-D WHEEL BEARING GREASE



G. SCREAMIN' EAGLE ASSEMBLY LUBE



I. H-D SPECIAL PURPOSE GREASE



K. H-D HIGH-PERFORMANCE SEALANT – GRAY

GARAGE 691

Oil & Lube

F. H-D® ETHANOL GUARD FUEL STABILIZER

Blended with corrosion inhibitors, this Fuel Stabilizer is formulated to protect fuel tanks, fuel lines, carburetors and injectors from long-term exposure to the adverse affects of ethanol-blended fuel. It fights deposits that can accumulate as a result of ethanol-produced solvents, and acts as a demulsifier to eliminate condensation in your fuel system. 4 ounces treats 10 gallons of fuel.

91600001	4 fl oz (118 ml) Bottle.	\$6.95
-----------------	--------------------------	---------------

G. SCREAMIN' EAGLE® ASSEMBLY LUBE

Screamin' Eagle® Assembly Lube provides superior protection during installation or servicing of internal engine components. Formulated with a high tackifier, this lubricant clings to parts and provides excellent start-up and break-in protection. It provides excellent corrosion resistance, and it won't drip off like common oil when you set coated parts aside to work on the rest of the engine. Recommended applications: cams, gears, crankpins, piston wrist pins, oil pumps, valve guides, rocker arm and push rod tips and roller tappet wheels.

11300002	4 fl oz (118 ml) Tube.	\$13.95
-----------------	------------------------	----------------

H. HARLEY LUBE

Harley Lube is a Harley-Davidson approved general lubricant.

94968-09	.25 fl oz (7.5 ml) Tube.	\$6.95
-----------------	--------------------------	---------------

I. H-D SPECIAL PURPOSE GREASE

Factory approved steering head bearing lubricant for '02-later VRSC, '15-later XG, '05-later XL and XR and '97-later Dyna®, Softail® (except Springer™), Touring and Trike models. Do not use on wheel bearings.

99857-97A	14 oz (409 g) Grease Gun Cartridge.	\$14.95
------------------	-------------------------------------	----------------

J. H-D WHEEL BEARING GREASE

Recommended for wheel bearings and rear swingarm bearings.

99856-92	14 oz (409 g) Grease Gun Cartridge.	\$11.95
-----------------	-------------------------------------	----------------

K. H-D HIGH-PERFORMANCE SEALANT – GRAY

High-performance, room temperature vulcanized (RTV) silicone type liquid gasket is a low-odor, non-corrosive and non-conductive sensor-safe formula. Sealant allows high elongation when cured to absorb thermal and dynamic movement of the mating surfaces and is resistant to most chemicals and solvents. Temperature Range -76°F to 482°F (-60°C to 250°C).

99650-02	1.9 oz (54 g) Tube.	\$17.95
-----------------	---------------------	----------------

Approved for use as crankcase sealant on all Harley-Davidson powertrains.

Notice: The prices appearing in this catalog are the manufacturer's suggested retail prices. Actual retail prices may vary.

Notice: The prices appearing in this catalog are the manufacturer's suggested retail prices. Actual retail prices may vary.

SURFACE CARE PRODUCT MAP

CLEAN

GENERAL



93600056 US
Harley® Bike Wash Kit



94844-10 GLOBAL
Cleaning Brush Kit



93600110 GLOBAL
Bug Eater Sponge



93600133
Harley® Bike Wash Bucket
GLOBAL



94651-09 N.AMERICA
HOG® Blaster Motorcycle Dryer



93600141 INT
93600129 US
Sunwash® Bike Soap

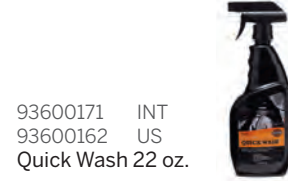

93600171 INT
93600162 US
Quick Wash 22 oz.



93600132 GLOBAL
H-D Microfiber Soft Drying Towel



93600140 INT
93600122 US
Bug Remover



93600130
Wash Mitt
GLOBAL

GLASS

93600169 INT
93600166 US
Harley-Davidson Graphene Clear Coat, 8oz



93600084 INT
93600029 US
Spray Cleaner & Polish



PAINT

93600127 INT
93600124 US
Denim Paint Cleaner



93600084 INT
93600029 US
Spray Cleaner & Polish



LEATHER, VINYL & TRIM

93600170 INT
93600167 US
Seat, Saddlebag & Trim Cleaner, 8oz. Bottle



METAL: CHROME, ALUMINUM & ENGINE

93600082 INT
93600031 US
Chrome Clean & Shine



93600084 INT
93600029 US
Spray Cleaner & Polish



WHEEL & TIRE

93600126 INT
93600121 US
Wheel & Tire Cleaner



43078-99 GLOBAL
Wheel & Spoke Brush



DETAIL

93600057A US
Harley® Detail & Protect Kit



93600125 INT
93600123 US
Gloss Detailer



93600125 INT
93600123 US
Gloss Detailer



93600156 INT
93600155 US
Scratch & Swirl Repair 8 oz.



93600081 INT
93600033 US
Black Leather Rejuvenator



93600068 INT
93600002 US
Engine Brightener



93600083 INT
93600028 US
Bare Metal Polish
(For use on bare aluminum surfaces only)



93600136 GLOBAL
Microfiber Detailing Cloth 3 pack



93600168 GLOBAL
Microfiber Applicator 4 pack



93600084 INT
93600029 US
Spray Cleaner & Polish



PROTECT

93600169 INT
93600166 US
Harley-Davidson Graphene Clear Coat, 8oz



93600169 INT
93600166 US
Harley-Davidson Graphene Clear Coat, 8oz



93600080 INT
93600034 US
Leather Protectant



93600169 INT
93600166 US
Harley-Davidson Graphene Clear Coat, 8oz
(Not for engine)



694 GARAGE

Surface Care

A. H-D™ QUICK WASH CLEANER

Fast and easy to use, Quick Wash is tough on dirt, oil and bugs, but gentle on other surfaces. Just spray it on and hose it off. Quick Wash gets into hard-to-reach spaces and cleans without scrubbing. Safe for use on all motorcycle surfaces. Does not strip wax, corrode fasteners or spokes or stain leather and vinyl seats and saddlebags. Sheeting action rinses clean and prevents spotting. Simply spray on, wait one minute and hose it off. Available in easy-to-handle trigger pump bottles and convenient refill containers.

22 fl oz Bottle.

93600162	U.S.	\$14.95
93600171	International.	\$16.95

B. SUNWASH® BIKE SOAP

This revolutionary cleaner lets riders wash their bikes where they want to – in the sun. Most bike wash products can be used only on cool days or in the shade. Has a unique formulated sheeting action that minimizes hard water spots and rinses clean even on hot days in the sun. Safe for use on all vehicle surfaces including denim paint. Biodegradable.

8 fl oz (236 ml) Bottle.

93600129	U.S.	\$16.95
93600141	International.	\$18.95

C. SPRAY CLEANER & POLISH

Keep your bike clean, even when you are away from home. Aerosol waterless quick cleaner/detailer is the perfect choice when the motorcycle is too clean to wash but too dirty to ride. Safe for use on metal, painted, plastic and windshield surfaces, this cleaning spray dissolves road grime and bugs for quick and easy cleaning and detailing. The spray floats dirt off the motorcycle, reduces static attraction to dust and leaves the surface with a great shine and UV protection.

11 oz (311 g) Aerosol Can.

93600029	U.S.	\$8.95
93600084	International.	\$9.95

D. BUG REMOVER

Remove bugs with little effort. Bugs have natural acids in their systems that can prove to be very damaging to motorcycle finishes if not removed. Melts away bugs and is safe for use on metal, painted and plastic surfaces, including Harley-Davidson® windshields. Biodegradable.

16 fl oz (473 ml) Spray Bottle.

93600122	U.S.	\$15.95
93600140	International.	\$17.95

E. WHEEL & TIRE CLEANER

The road provides plenty of nasty elements that can be potentially damaging to the finish of motorcycle wheels. Wheel & Tire Cleaner safely removes brake dust and road grime from wheels, tires and whitewalls in seconds. Also recommended for cleaning Harley-Davidson® black-coated exhaust pipes and mufflers. Biodegradable.

22 fl oz Spray Bottle.

93600121	U.S.	\$15.95
93600126	International.	\$17.95



A. QUICK WASH



F. DENIM PAINT CLEANER



G. SEAT, SADDLEBAG & TRIM CLEANER



B. SUNWASH BIKE SOAP



C. SPRAY CLEANER & POLISH



H. CHROME CLEAN & SHINE



I. GLOSS DETAILER



D. BUG REMOVER



E. WHEEL & TIRE CLEANER



J. SCRATCH & SWIRL REPAIR



K. ENGINE BRIGHTENER

GARAGE 695

Surface Care

F. DENIM PAINT CLEANER

Specially formulated for denim paint, this handy quick detailer cleans and protects the silky matte finish. Cleaner won't streak or leave residue. Just spray and gently wipe away oils, fingerprints and dust. Compatible with all surfaces on Harley-Davidson® motorcycles, this formula cleans without buffing, so you can avoid polishing the denim surface. Heavily soiled surfaces should be washed with Sunwash® Bike Soap and water before application.

16 fl oz (473 ml) Spray Bottle.

93600124	U.S.	\$14.95
93600127	International.	\$16.95

G. SEAT, SADDLEBAG, AND TRIM CLEANER

The ideal quick detailer for vinyl, leather and plastic surfaces, this one-step treatment cleans and refreshes without leaving a greasy residue. Use a microfiber applicator to apply gel directly onto the surface. Buff away the accumulated dust and grime that dulls the finish with a microfiber cloth. Ideal for use on inner fairings, dash panels, seats and saddlebags. Dries to a satin shine and contains no waxes or other solvents that can dull the surface of vinyl and plastic.

8 fl oz (236 ml) Bottle.

93600167	U.S.	\$11.95
93600170	International.	\$13.95

H. CHROME CLEAN & SHINE

Professional strength nonabrasive cleaner is formulated to ensure maximum shine on chrome-plated surfaces. The detergent-resistant formula is easy to apply and can be buffed to a bright, long-lasting finish. Can also be used to clean decorative brushed aluminum, brass and stainless steel surfaces.

4 oz (113 g) Container.

93600031	U.S.	\$10.95
93600082	International.	\$11.95

I. GLOSS DETAILER

This easy-to-apply mist produces the highest possible gloss finish in the shortest amount of time. Formulated to enhance luster and provide UV protection between waxes, this nonabrasive quick detailer can be applied to paint, clear coat, chrome, powder coat, windshields, vinyl and plastic. Gloss Detailer contains no waxes, silicones, oils or hydrocarbon solvents and will not remove Glaze™ Poly Sealant. Biodegradable.

16 fl oz (473 ml) Spray Bottle.

93600123	U.S.	\$16.95
93600125	International.	\$18.95

J. SCRATCH & SWIRL REPAIR

Formulated to remove fine scratches and swirl marks from gloss paint, this unique compound contains nonrigid abrasives that provide good initial leveling action on clear coat and become less aggressive while being buffed. This staging of grit size provides the benefits of a several-step process in one convenient bottle and leaves your clear coat with a new bike shine. Biodegradable.

8 fl oz (236 ml) Bottle.

93600155	U.S.	\$11.95
93600156	International.	\$11.95

K. ENGINE BRIGHTENER

Make your engine look new again. Engine Brightener refreshes and rejuvenates tired wrinkle black finishes on engine cases, cylinder fins, covers or anywhere else the color has faded or lost its luster. Formulated with high-temperature silicon polymer, this detergent-resistant finish restorer cleans deep into the wrinkle black surface and moisturizes the finish to return the original satin sheen. Just spray it on, let it soak in and wipe away for a fresh look.

11 oz (311 g) Aerosol Can.

93600002	U.S.	\$18.95
93600068	International.	\$18.95

Notice: The prices appearing in this catalog are the manufacturer's suggested retail prices. Actual retail prices may vary.

Notice: The prices appearing in this catalog are the manufacturer's suggested retail prices. Actual retail prices may vary.

696 GARAGE

Surface Care

A. H-D™ GRAPHENE SPRAY COATING

Give your motorcycle finish a new level of protection with H-D™ Graphene Spray Coating. Contains a graphene oxide component that provides a high level of long-lasting protection, reduces hard-water spotting, and keeps water from clinging to the surface. Enhances the gloss and clarity of painted and plated finishes and is easy to apply. Great for use on paint, chrome, and wheels. Not for use on brakes, tires, denim, semi-gloss or wrinkle finish surfaces. On paint creates a hard layer of scratch protection. Repels brake dust from wheels. Preserves and protects plastic surfaces. Lowers surface temperature to reduce hard water spotting embedded in clear coat. Prevents water from clinging on treated surfaces. May be applied in direct sunlight. May be applied over existing wax or polish coating.

8 fl oz (236 ml) Bottle.

93600166 U.S. **\$19.95**

93600169 International. **\$21.95**

B. BLACK INNER FAIRING REJUVENATOR

Great for sun-rich environments, this Inner Fairing Rejuvenator brings back the deep black color on faded Original Equipment satin-black inner fairing surfaces. Just wipe on and buff off. An occasional application restores the luxurious matte finish and provides added UV protection. Can also be used on rubber and other black plastic components.

93600115 8 fl oz (236 ml) Bottle. **\$18.95**

C. BLACK LEATHER REJUVENATOR

Black Leather Rejuvenator puts new life back into faded black leather seats and saddlebags. To re-color and condition weathered leather, just clean the surface and apply the treatment with a Disposable Detailing Soft Cloth. Wipe off the excess, buff the leather surfaces to the desired shine, and your leather looks like new. For lasting weather protection, follow the application with H-D® Leather Protectant.

4 oz (113 g) Container.

93600033 U.S. **\$8.95**

93600081 International. **\$9.95**

D. LEATHER PROTECTANT

Leather Protectant offers the most effective weatherproofing and preservative action for leather saddlebags, tank panels, gear and apparel. Specially formulated for smooth, oil-tanned leather.

6 oz (170 g) Container.

93600034 U.S. **\$8.95**

93600080 International. **\$9.95**

E. BARE METAL POLISH

Professional strength micro-abrasive polish is formulated to remove oxidation and refurbish metal motorcycle parts that have lost their original finish. Recommended for use on polished aluminum or polished stainless steel surfaces that are not clear coated. Can also be used to polish Brass Collection components to a bright finish. Not for use on painted, chromed or plated surfaces or decorative brushed aluminum or stainless steel finishes.

4 oz (113 g) Container.

93600028 U.S. **\$10.95**

93600083 International. **\$10.95**

F. TIRE LETTERING PEN

Enhance your tire sidewall lettering by applying White paint. Acrylic ester resin paint provides excellent water resistance with improved color and gloss retention. Pump action paint dispensing pen allows either outlining or filling the lettering. Tip can be shaped or trimmed to allow for customized paint flow.

98625 1/3 fl oz – White. **\$10.95**



A. H-D GRAPHENE SPRAY COATING



B. BLACK INNER FAIRING REJUVENATOR



C. BLACK LEATHER REJUVENATOR



D. LEATHER PROTECTANT



E. BARE METAL POLISH



F. TIRE LETTERING PEN



G. BIKE WASH BUCKET



H. FIREMAN-STYLE HOSE NOZZLE



I. MICROFIBER WASH MITT – ORANGE



J. WHEEL AND SPOKE BRUSH

GARAGE 697

Surface Care

G. BIKE WASH BUCKET

The perfect way to keep your bike clean, this bike wash bucket holds the key to lustrous shine. 5.0-gallon cleaning bucket features a removable Grit Guard® insert that keeps sponges and wash mitts away from the dirt particles that settle to the bottom. Use it to store cleaning products between washes.

Sturdy handle and screw-on, water-tight lid make transportation and storage a breeze.

93600133 **\$46.95**

H. FIREMAN-STYLE HOSE NOZZLE

Wash your bike in style. The unique Fireman-Style hose nozzle features a large overhand lever for convenient operation. Just adjust the lever and the nozzle maintains the pressure flow – hands free. The spray head adjusts from a steady stream to a wide fan pattern and the soft rubber nose cone protects your bike's surfaces from accidental contact. The durable metal body won't rust or corrode and the soft-touch ergonomic grip is insulated for cold-water comfort. Standard-size garden hose fitting includes gasket.

93600016 **\$23.95**

I. MICROFIBER WASH MITT – ORANGE

Premium quality microfiber mitt lifts away dirt particles from motorcycle surfaces to help prevent scratches to the finish during washing. Microfiber draws dirt from surfaces as you wash the bike. Machine washable. Custom designed to be used with either hand.

93600130 **\$17.95**

J. WHEEL AND SPOKE BRUSH

The perfect partner for Wheel & Tire Cleaner, this brush features soft, durable fibers attached to a base coated with polypropylene to prevent scratching. With a Bar & Shield logo branded into the handle, the brush has a cone shape for efficient cleaning and durable design that won't melt on hot surfaces.

43078-99 **\$19.95**

Notice: The prices appearing in this catalog are the manufacturer's suggested retail prices. Actual retail prices may vary.

Notice: The prices appearing in this catalog are the manufacturer's suggested retail prices. Actual retail prices may vary.

698 GARAGE

Surface Care

A. CLEANING BRUSH KIT

Make every corner of your bike shine. This set of 3 wood-handled cleaning brushes helps you reach into the tightest places. The chamois brush gently scrubs in between engine fins or can be used after rinse to soak up hard-to-reach water. The reverse spiral brush is perfect for cleaning tire sidewalls or those hard-to-reach spaces elsewhere on your bike, and the soft mop brush will leave your chrome streak free. All brushes have vinyl-coated wires to prevent scratching.

94844-10 **\$33.95**

B. BUG EATER SPONGE

Tough on bugs but gentle on other surfaces. This easy-to-grip pad features a strong, flexible core laminated with double-sided cleaning surfaces. When paired with water and Bug Remover or Wheel & Tire Cleaner sprays, the textured orange surface helps break down and dissolve baked-on bugs and road grime without scratching the surface below.

93600110 **\$8.95**

C. MICROFIBER APPLICATOR

Get pro detailing results faster. The flat surface of this microfiber applicator block covers more area for faster application. For use on the application of most wax, coating, sealant, and dressing products. Short pile terry microfiber fabric absorbs minimal product while applying the product evenly and smoothly. Medium-firm sponge core gently conforms to contoured motorcycle surfaces. The inside sewn edges ensure that only microfiber fabric comes in contact with paint. Pad fits right in the palm of your hand - is easy to hold and maneuver. Measures 5 x 3 x 0.75. Sold as pack of 4 applicators

93600168 4-pack. **\$14.95**

D. MICROFIBER DETAILING CLOTH

This premium microfiber synthetic cloth is the multi-purpose choice for washing, cleaning or buffing. Highly absorbent fibers make it the best microfiber material for use on your motorcycle. Designed to help prevent scratching and allow detailing into tight corners, spaces and gaps. Edges designed not to fray after many uses. Now available in a convenient three-pack

93600136 **\$25.95**

E. MICROFIBER SOFT DRYING TOWEL

Ditch that old dishrag. This microfiber drying towel can absorb much more water than a cotton towel, enough to make short work of drying even Touring motorcycles. Washable and reusable. Provides a lint- and streak-free drying action for a professional result. Softer than cotton, this plush towel is ideal for use on any surface. Compact size is ideal for packing for morning wipe-downs on road trips

93600132 **\$17.95**

F. DETAILING SWABS

Detail those hard-to-reach places. Plush cotton swabs are perfect for removing polish and wax residue from cracks and crevices, and the strong but flexible 8 shaft allows you to clean in hard to reach areas around your engine, pipes and more. Package contains 50 swabs.

93600107 **\$9.95**



A. CLEANING BRUSH KIT



B. BUG EATER SPONGE



D. MICROFIBER DETAILING CLOTH



C. MICROFIBER APPLICATOR



E. MICROFIBER SOFT DRYING TOWEL

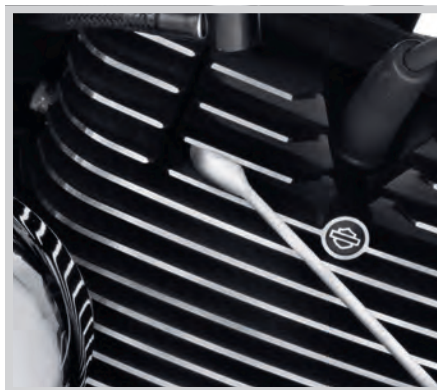

F. DETAILING SWABS



G. HARLEY BIKE WASH KIT



H. HARLEY DETAIL & PROTECT KIT

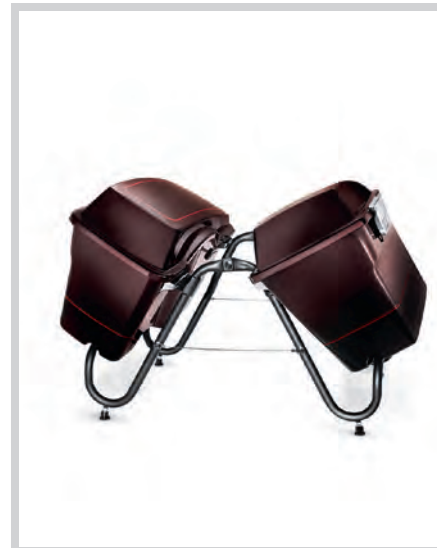

I. SADDLEBAG STORAGE STAND



J. HOG BLASTER MOTORCYCLE DRYER



GARAGE 699

Surface Care

G. HARLEY® BIKE WASH KIT

Bike Wash Kit includes the essentials required to clean your bike.

- Sunwash® Bike Soap
- Bug Remover
- Wash Mitt
- Bug Eater Sponge
- Synthetic Drying Chamois
- Microfiber Detailing Cloth

93600056 **\$52.95**

H. HARLEY DETAIL & PROTECT KIT

Detail & Protect Kit includes the essentials to make your bike shine.

- Glaze™ Poly Sealant
- Gloss Detailer
- Chrome Clean & Shine
- Scratch & Swirl Repair
- Disposable Detailing Soft Cloths
- Microfiber Detailing Cloth
- Detailing Swabs

93600057A **\$59.95**

I. SADDLEBAG STORAGE STAND

Never set your saddlebags on the ground again. This convenient folding rack holds Touring hard saddlebags while you wash or work on your bike and utilizes the bag's quarter-turn quick-disconnect fasteners to securely lock them in place. The strong, lightweight rack features 4 adjustable feet to level the stand and keep the bags off the ground. You can wash, dry, detail and re-install the bags with minimal handling. Stand accommodates both standard and extended hard saddlebags.

94778-10 **\$107.95**

Fits '95-'16 Touring models equipped with standard and extended-length saddlebags.

J. HOG® BLASTER MOTORCYCLE DRYER

Dry your bike in minutes with the HOG® Blaster. This powerful dryer blows a stream of warm, dry, filtered air at 18,000 feet/minute, allowing you to cut your drying time up to 75%. The HOG Blaster reduces streaks and water spots because water can't hide in hard-to-reach places. No more annoying drips and runs when you move your bike. With an ergonomically friendly design for comfortable handling, the HOG Blaster features a durable all-steel outer shell, a 1.3 hp motor and a grounded electrical cord. Kit includes blower unit, flexible hose and 2 diffuser attachments. One-year manufacturer's warranty on blower unit.

94651-09 120V, Grounded 3-prong Plug. **\$134.95**
United States, Canada and Mexico.

HARLEY-DAVIDSON® MOTORCYCLE COVERS

Welcome to the best-dressed list. Unlike a tarp and bungee cords, Harley-Davidson® Motorcycle Covers fight the effects of the elements and protect your bike's paint and finishes from the rough world around us. Whether your bike spends its time in a heated garage or on the driveway, we've got you covered.

ANTENNA ACCESS
Touring and Trike covers feature hook-and-loop opening at the rear to accommodate antennas.

WATER-RESISTANT SEAMS
Heavy-duty Indoor/Outdoor covers feature taped overlapping seams for water resistance.

MOISTURE REDUCTION
Weather-shielded vents or breathable materials promote air circulation and minimize corrosion during short or long term storage.

HEAT-RESISTANT PANELS
Indoor/Outdoor and Premium Indoor Covers feature heat-resistant panels that protect the cover from warm exhaust.

REFLECTIVE TRIM
High-visibility reflective trim makes a parked and covered bike more obvious.

BELLY STRAPS
Quick-release adjustable straps cinch the cover under the frame to reduce ballooning in the wind.

INTEGRATED STORAGE POUCH
After use, just fold the cover into the convenient integrated storage pouch.



CORSET-STYLE BACKBONE
Medium and large covers feature a cinching system that customizes the cover for best fit. Just pull the cord and cover adjusts to the bike's contours.

ADJUSTABLE HEM
Drawstring hem allows custom-tailored fit around the bike and eliminates the one-size-fits-some elastic cord.

LOCK ACCESS
Sewn-in grommets near the front wheel simplify the use of a cable lock or security chain (cable/lock not included).

COVER ALARM POCKET
Hidden pocket accepts optional battery-powered alarm. If the cover is disturbed, the 130-dB alarm is triggered.

	COMPACT TRAVEL	INDOOR	PREMIUM INDOOR	INDOOR/OUTDOOR	
MATERIAL	2x Polyurethane Coated Polyester	Polyester	Luxuriously Soft Microfiber	Heavy-Duty UV Resistant Diamond Pattern Polyester	
WATER-RESISTANT	✓	—	—	✓	
HEAT PANEL	—	—	✓	✓	
ANTENNA ACCESS	✓	—	✓	✓	
SECURITY FEATURES	—	Sewn-in grommets for use of front wheel chain lock & hidden internal alarm pocket			
ADJUSTABILITY	—	Corset-Style Backbone & Adjustable Hem			
REFLECTIVE TRIM	✓	✓	✓	✓	✓
INTEGRATED STORAGE POUCH	✓	✓	✓	✓	✓
BELLY STRAP	—	✓	✓	✓	✓
H-D LOGO	✓	✓	✓	✓	—
ADVENTURE TOURING	Large 93100073 \$94.95	—	—	ADV 93100070 \$186.95	—
STREET™ & SPORTSTER®	Medium 93100074 \$83.95	Small 93100043 \$107.95	—	Small 93100040 \$160.95	Small – Solid Black 93100041 \$149.95
V-ROD®, DYNA® & SOFTAIL®	Medium 93100074 \$83.95	Large 93100018 \$107.95	Medium 93100019 \$160.95	Medium 93100022 \$160.95	Medium – Solid Black 93100025 \$149.95
TOURING	Large 93100073 \$94.95	Large 93100018 \$107.95	Large 93100020 \$170.95	Large 93100023 \$170.95	Large – Solid Black 93100026 \$160.95
TRIKE	—	Large 93100018 \$107.95	Extra-Large 93100021 \$201.95	Extra-Large 93100024 \$201.95	Extra-Large – Solid Back 93100027 \$191.95

✓ Standard Feature

*NOTE: H-D® motorcycle covers are not designed to be used while trailering. Using an H-D motorcycle cover while trailering may cause the cover to tear, possibly causing damage to the cover and motorcycle.

Notice: The prices appearing in this catalog are the manufacturer's suggested retail prices. Actual retail prices may vary.

702 GARAGE

Motorcycle Covers

A. COMPACT TRAVEL COVERS

Travel with protection. This lightweight, water-resistant Compact Travel Cover is easy to pack and covers the main motorcycle touch points from the windshield to the rear seating area. Compact and lightweight cover stores in its own pouch and requires over 40% less luggage space than a full-size motorcycle cover, so it's easy to pack along just in case. When compacted in pouch, travel cover takes up less space than a 64Oz aluminum drink container. Multiple attachment options to adjust the fit based on motorcycle model and luggage option so cover can be used on different bikes. Minimize motorcycle wipe-down after dew or light rain. Discourages tampering with the covered motorcycle for an added layer of security. Reflective logos highlight the front, rear, and sides of vehicle for added visibility when the motorcycle is parked at night offer peace of mind. Made from polyester with a water-resistant polyurethane coating.

93100073 Large. **\$94.95**
Fits '21-later Pan America® and '14-later Touring and Tri-Glide® models. Recommended for any model with Tour-Pak® luggage installed.

93100074 Medium. **\$83.95**
Fits '21-later RH1250S, '12-later XG, '04-later XL models, and '18-later Softail models. Not recommended for any model with Tour-Pak® luggage installed.

B. INDOOR/OUTDOOR MOTORCYCLE COVER*

Weather-shielded vents in the top of the cover promote air circulation to reduce moisture build-up and minimize corrosion. Internal heat-resistant panels protect the cover from warm exhaust and an integrated storage pouch permits convenient packing. The cover skirt features front and rear adjustable drawstrings to cinch the cover and a belly strap. Cover features a convenient opening near the front wheel for a security chain or cable and internal pockets that accept the optional Cover Alarm (P/N 69000038). The cover features reflective piping for added visibility. Fits any .875 to 1.25 diameter tubing.

Medium. Fits VRSC™, Dyna® and Softail® models.

93100022 H-D Orange/Black. **\$160.95**

93100025 Black. **\$149.95**

Large. Fits Touring and Freewheeler® models. Does not fit FLHXXX, FLTRT or FLHTCUTG models.

93100023 H-D Orange/Black. **\$170.95**

93100026 Black. **\$160.95**

Extra Large. Fits Trike models.

93100024 H-D Orange/Black. **\$201.95**

93100027 Black. **\$191.95**

C. PREMIUM INDOOR MOTORCYCLE COVER*

Promotes air circulation to reduce moisture build-up and minimize corrosion. The cover's skirt features front and rear adjustable drawstrings to cinch the cover and a belly strap. The cover features heat-resistant panels that protect the material from warm exhaust. Cover features a convenient opening near the front wheel for a security chain or cable and internal pockets that accept the optional Cover Alarm (P/N 69000038).

Small. Fits XG, XL and XR models.

93100042 H-D Orange/Black. **\$160.95**

Medium. Fits VRSC, Dyna and Softail models.

93100019 H-D Orange/Black. **\$160.95**

Large. Fits Touring and Freewheeler models. Does not fit FLHXXX, FLTRT or FLHTCUTG models.

93100020 H-D Orange/Black. **\$170.95**

Extra large. Fits Trike models.

93100021 H-D Orange/Black. **\$201.95**

D. INDOOR MOTORCYCLE COVER*

This breathable polyester cover promotes air circulation to reduce moisture build-up and minimize corrosion. The cover's skirt features front and rear adjustable drawstrings to cinch the cover around the bike and a convenient belly strap. The cover features a convenient opening near the front wheel for a security chain or cable and internal pockets that accept the optional Cover Alarm (P/N 69000038).

Small. Fits XG, XL and XR models.

93100043 H-D Orange/Black. **\$107.95**

Large. Fits Touring, Freewheeler and RH models.

93100018 H-D Orange/Black. **\$107.95**

Notice: The prices appearing in this catalog are the manufacturer's suggested retail prices. Actual retail prices may vary.



*NOTE: H-D® motorcycle covers are not designed to be used while trailering. Using an H-D motorcycle cover while trailering may cause the cover to tear, possibly causing damage to the cover and motorcycle.



***WARNING:** Do not use while riding; could result in death or serious injury.

MOTORCYCLE COVERS



E. OASIS DAY COVER



F. MOTORCYCLE COVER ALARM



G. RAIN COVER – SOLO SEAT



H. SERVICE COVER



H. SERVICE COVER

GARAGE 703

Motorcycle Covers & Storage Accessories

E. OASIS DAY COVER*

Keep your seat dry when you stop for the night. Lightweight and compact for travel, this easy-to-store cover rolls into the built-in bag. Made from soft micro-fiber, the black and orange water repellent fabric dries quickly for a quick getaway. Hook-and-loop closures in the rear let you slip the cover over your antennas and the elastic bottom hem and footboard stirrups ensure a snug fit. The Harley-Davidson script and Bar & Shield logos prominently stand out on the fabric.

93100028 H-D Orange/Black. **\$118.95**
Fits Touring and Trike models equipped with Tour-Pak® luggage.

F. MOTORCYCLE COVER ALARM

Protect your covered motorcycle from tampering. Self-contained alarm fits into the pocket on select H-D® Motorcycle Covers. The snap swivel clips to spokes, rotors or other fixed parts and the cord leads back to the alarm pin. If the cover is pulled off the bike, the pin is pulled, triggering the 130-dB alarm. Weatherproof alarm is powered by a replaceable 9V battery (not included).

69000038 **\$33.95**
Fits select H-D Motorcycle Covers with alarm pocket.

G. RAIN COVERS*

Featuring a handy storage sack, this black nylon, water-resistant, Cordura® cover packs easily and shelters your seat from the storm.

51638-97 Solo Seat. **\$33.95**
Fits H-D® solo seats (except XR and FLSTS).

51639-97 Two-Up Seat. **\$35.95**
Fits VRSC™, XG, XL, Dyna® and Softail® models with Two-Up Seats. Does not fit Touring and Trike models. Does not fit with Rider Backrests.

52952-97 Seat with Rider Backrest. **\$43.95**
Fits H-D Touring and Trike seats. Fits with accessory rider backrest. Includes rain cover for Tour-Pak® mounted passenger backrest.

H. SERVICE COVERS*

Protect the finish on your tank and fenders while performing routine service on your motorcycle. These custom shaped covers feature an easy-to-clean black vinyl outer surface and a soft non-abrasive fleece inner liner. Fuel tank covers feature built-in magnets to prevent the cover from sliding, convenient mesh pockets to keep small parts from rolling away and a clear paperwork window for notes and instruction sheets. Fender covers feature soft elastic bands to keep the covers firmly in place. To complete the look, the cover features a nostalgic Harley-Davidson logo that will look great in any garage.

94640-08 Large Fuel Tank. **\$36.95**
Fits Dyna®, Softail®, Touring and Trike models.

94641-08 Large Front Fender. **\$35.95**
Fits '12-'16 FLD, '86-'17 FL Softail (except FLS and FLSS), '18-later FLDE, FLHC and FLHCS, and most Touring and Trike models.

*NOTE: H-D® motorcycle covers are not designed to be used while trailering. Using an H-D motorcycle cover while trailering may cause the cover to tear, possibly causing damage to the cover and motorcycle.



***WARNING:** Do not use while riding; could result in death or serious injury.

Notice: The prices appearing in this catalog are the manufacturer's suggested retail prices. Actual retail prices may vary.

704 GARAGE

H-D® Detachables™ Storage

A. REMOTE CONTROL GARAGE DOOR OPENER KIT

Operate your automatic garage door opener without leaving your motorcycle seat or fumbling in your pocket for the remote control. Compatible with most brands of automatic openers, this kit allows you to operate your door by cycling the bike's high-beam switch. The hidden transmitter splices into your bike's wiring harness and is powered by your vehicle battery, so there are no transmitter batteries to replace. When your key is switched off the transmitter is disabled, providing added garage security if you park your bike outside. The signal is sent to the in-garage receiver that plugs into a standard 110-volt outlet and is wired to the automatic opener. The receiver's rolling code technology provides additional security. Kit includes one transmitter and one receiver. Individual components are available to equip additional motorcycles and garages.

91558-01B Complete Kit. **\$158.95**
Fits '02-'17 VRSC™, '15-'20 XG, '94-later XL, '08-'13 XR, '96-'17 Dyna, '96-later Softail®, and '94-later Touring and Trike models. '14-later XL, '12-'17 Dyna® and '11-'17 Softail models require separate purchase of Electrical Connection Kit P/N 72673-11. '14-'16 Touring and Trike models require separate purchase of Electrical Connection Kit P/N 69200722. '18-later Softail and '17-later Touring and Trike models require separate purchase of Electrical Connection Kit P/N 69201599A. '15-'20 XG models require separate purchase of P/N 72136-94GY, 72156-94 and Qty. 4 72195-94. Not compatible with Chamberlain®/Liftmaster® MyQ® or Sears® Craftsman AssureLink™ garage door openers.

1. Remote Control Garage Door Opener Transmitter

This kit allows owners of the Remote Garage Door Opener P/N 91558-01B to equip each of their Harley-Davidson® motorcycles with a remote transmitter.

91561-01B **\$79.95**
For use with Remote Control Garage Door Opener Kit P/N 91558-01B. '15-'20 XG models require separate purchase of P/N 72136-94GY, 72156-94 and 4x 72195-94. '14-later XL, '12-'17 Dyna and '11-'17 later Softail models require separate purchase of Electrical Connection Kit P/N 72673-11. '14-'16 Touring and Trike models require separate purchase of Electrical Connection Kit P/N 69200722. '18-later Softail and '17-later Touring and Trike models require separate purchase of Electrical Connection Kit P/N 69201599A.

2. Remote Control Garage Door Opener Receiver

This additional receiver permits the owner of the Remote Garage Door Opener P/N 91558-01B to operate more than one garage door opener from a single transmitter.

91562-01 **\$79.95**
For use with Remote Control Garage Door Opener Kit P/N 91558-01B. Not compatible with Chamberlain/Liftmaster MyQ or Sears Craftsman AssureLink garage door openers.

B. DETACH DEPOT WALL RACK

This heavy-duty Detach Depot Wall Rack can be mounted to any wall, and the 16 on-center design lets you mount it securely to the studs. The rack features 5 coated rods that can be positioned in a wide variety of adjustable mounting slots. Adjustable rods can accommodate almost any combination of accessories. Kit includes black-finished side panels, 5 coated rods, decorative end caps and all necessary mounting hardware.

93100005 **\$213.95**
For use with Harley-Davidson® Detachables and HoldFast™ products including Tour-Pak Mounting Racks, Sissy Bars, Luggage Racks, Rider Backrests and H-D Detachables-style Windshields. Quick-Release style Windshields and Rider Backrests require separate purchase of auxiliary mount kits.

C. DETACH DEPOT QUICK-RELEASE WINDSHIELD MOUNTS

93100015 **\$28.95**
For use with Harley-Davidson® Quick-Release Windshields (except XG) and Detach Depot Wall Rack P/N 93100005.

D. DETACH DEPOT RIDER BACKREST MOUNT

93100016 **\$28.95**
For use with Harley-Davidson® Touring and Trike Rider Backrest and Adjustable Rider Backrest Kits and Detach Depot Wall Rack P/N 93100005.



A. REMOTE CONTROL GARAGE DOOR OPENER KIT



B. DETACH DEPOT WALL RACK



C. DETACH DEPOT QUICK-RELEASE WINDSHIELD MOUNTS



D. DETACH DEPOT RIDER BACKREST MOUNT



E. CRUISER CRADLE WHEEL CHOCK

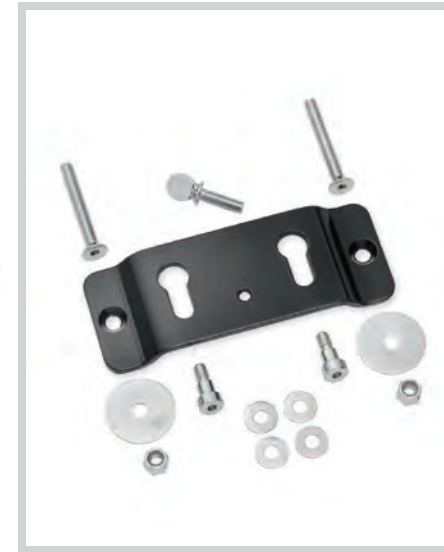

F. CRUISER CRADLE TRAILER ADAPTER KIT



G. CRUISER CRADLE WHEEL CHOCK - TRAILER ONLY VERSION



H. CRUISER CRADLE UNIVERSAL E-TRACK ADAPTER KIT (SHOWN WITH WHEEL CHOCK)



I. MOTORCYCLE SERVICE LIFT

GARAGE 705

Motorcycle Cradles & Tie-Downs

E. CRUISER CRADLE WHEEL CHOCK

This sturdy aluminum wheel chock will hold your bike securely on the ground, on a trailer or in the back of a pickup truck. Sized to fit most motorcycles, this wheel chock will keep your bike upright while you are storing, transporting or working on your bike. The lightweight, folding wheel chock is easy to transport. Use it on the driveway when you are washing your bike or, when equipped with the optional Trailer Adapter, the versatile wheel chock can be easily moved to a trailer or the back of a pickup truck. Just two tie-down straps are required to hold the bike in place. And because you don't need to over-tighten the straps, you won't damage sensitive suspension parts and handlebar bushings.

92900001 **\$304.95**
For use with models with vehicle weight up to 3000 lb (1360 kg) and front or rear wheel size of 14 to 22 (355-560mm) rim diameter and 3.15 to 8.66 (80mm-220mm) nominal wheel width. Not for use with Custom Wrapped Front Fenders.

F. CRUISER CRADLE TRAILER ADAPTER KIT

Engineered to simplify installation of Cruiser Cradle Wheel Chock on many trailers. Simply mount the low-profile kit to the floor of your trailer and the Cruiser Cradle can be attached in seconds, without tools.

92900002 **\$38.95**
For use with Cruiser Cradle Wheel Chock P/N 92900001 on trailer applications.

G. CRUISER CRADLE WHEEL CHOCK - TRAILER ONLY VERSION

Sized to fit most motorcycles, this wheel chock will keep your bike upright while you are transporting or working on your bike. Just two tie-down straps are required to hold the bike in place. The Trailer-Only chock can be removed from the trailer in seconds with four wing nuts or the optional E-Track Adapter and can be folded down when not in use. Includes all brackets and hardware to mount a trailer or lift table.

92900042 **\$232.95**
For use with models with vehicle weight up to 3000 lbs (1360 kg) and front or rear wheel size of 14 to 22 (355-560mm) rim diameter and 3.15 to 8.66 (80mm-220mm) nominal wheel width.

H. CRUISER CRADLE UNIVERSAL E-TRACK ADAPTER KIT

You can adjust the position of the chock anywhere along the E-Track for maximum flexibility in positioning a motorcycle and the chock can be adjusted side-to-side between 27 and 43 wide. The Universal E-Track Adapter Kit includes all the necessary hardware and including a Boomerang Bar for added Wheel Chock stability. Ratchet tie-downs are required for transporting the motorcycle.

92900043 **\$164.95**
For use with Cruiser Cradle Wheel Chock P/N 92900001 or 92900042 on trailer applications.

I. MOTORCYCLE SERVICE LIFT

The 1,100 lb capacity lift can raise any 2-wheel Harley® model 16.9 from the floor. The lift features 2 fixed and 2 swivel heavy duty wheels and a removable T-handle for easy maneuverability. Kit includes lift and 2 tie-down straps. Not available for sale in Europe, Middle East and Africa.

92900004 **\$327.95**
Fits Harley-Davidson® V-Twin models (except Trike and models equipped with a Sidecar). Softail® models require Frame Protector Kit P/N 94675-99. Twin Cam-equipped Dyna® models require Adapter Kit P/N 98965-99, both sold separately.

706 GARAGE

Motorcycle Tie-Downs

A. HARLEY-DAVIDSON® 1.5 GRADUAL RELEASE RATCHET TIE-DOWN STRAPS

600 lbs Working Load – 1.5 x 66

These heavy-duty ratchet straps provide maximum tensioning power and a higher working load capacity with the added benefit of being able to release the tension one click at a time. The ratchet is built with a comfortable molded grip handle and a dual-direction reversing drive that permits the spindle to rotate backward releasing tension until it reaches 60 lbs. This option helps eliminate the snap back release common with most standard ratchet designs under heavy load and also permits the even tensioning of straps without having to release all of the webbing and start over. The strap also features heavy-duty 6,000 lb abrasion-resistant Nylon webbing, a built in Soft Hook with vinyl coated full-size S hook on the fixed end and a large closed end carabiner hook on the adjustable end to keep it hooked securely during the tie-down process. Sold in pairs.

94706-10 **\$54.95**
Ratchet Straps with Integrated Soft Hook.



A. 1.5 GRADUAL RELEASE RATCHET TIE-DOWN STRAPS

B. HARLEY-DAVIDSON 1.25 RATCHET TIE-DOWN STRAPS

400 lbs Working Load – 1.25 x 78

These 1.25 Harley-Davidson® Tie-Downs have a 1,200 lb capacity and feature Harley-Davidson scripted webbing with a loop handle for easy pulling. Vinyl-coated hooks feature spring loaded one-way wire loop gates that hold the hook in position, simplifying initial tie-down setup. Harley-Davidson Ratchet Tie-Down Straps feature lever-action ratchets for use when greater tensioning power is needed. Straps are also available with integrated soft hooks that are designed to keep the coated hard hooks away from delicate surfaces. Sold in pairs.

94704-10 **\$54.95**
Ratchet Straps with Integrated Soft Hook.



C. HARLEY-DAVIDSON FLEECE SOFT HOOKS

C. HARLEY-DAVIDSON FLEECE SOFT HOOKS

400 lbs Working Load – 1.25 x 18

These 18 Soft Hooks are designed to keep ratchets, hooks and buckles away from delicate surfaces. The soft synthetic sheepskin cover cushions the surface and protects handlebars, triple trees and other tie-down points from scratches and abrasion. Each soft hook has a capacity of 2,400 lbs. Sold in pairs.

93100017 **\$22.95**

D. HARLEY-DAVIDSON SOFT HOOKS

400 lbs Working Load – 1.25 x 18

These Harley-Davidson 18 Soft Hooks keep ratchets and buckles away from delicate surfaces. Each soft hook has a capacity of 2,400 lbs. Sold in pairs.

94705-10 **\$14.95**

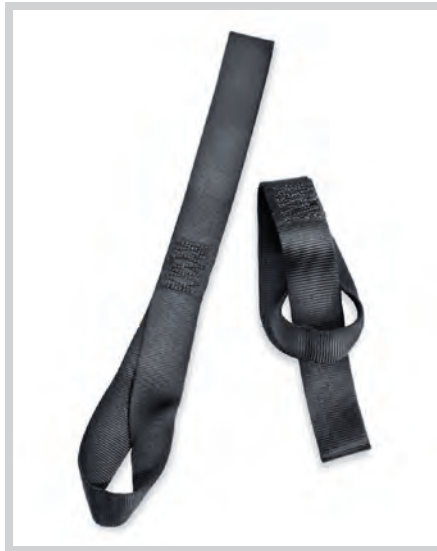

E. HOG TIES® SOFT HOOKS

600 lbs Working Load – 1.5 x 18

Wider and stronger, Hog Ties® Soft Hooks are designed to be used in conjunction with standard Hog Ties Straps to keep hooks from direct contact with handlebars, fairings, brake lines, wiring and painted surfaces. Secure to bike then secure tie-down hook to opposite end. Made with 6,000 lb Nylon webbing. Sold in pairs.

94650-98 **\$13.95**

F. ANCRA® RAT-PACK RATCHET STYLE TIE-DOWN STRAPS

400 lbs Working Load – 1 x 66

The original ratchet tie-down for motorcycles locks secure and provides the added tension needed to secure bikes and ATVs for longer hauls. Straps feature a wider grip ratchet handle, 4,500 lb abrasion-resistant nylon webbing, full-size vinyl coated S hooks on fixed ends and non-coated steel S hooks on the adjustable ends. Sold in pairs.

98187-90T **\$42.95**

E. HOG TIES SOFT HOOKS

Notice: The prices appearing in this catalog are the manufacturer's suggested retail prices. Actual retail prices may vary.



B. HARLEY-DAVIDSON 1.25 RATCHET TIE-DOWN STRAPS



D. HARLEY-DAVIDSON SOFT HOOKS

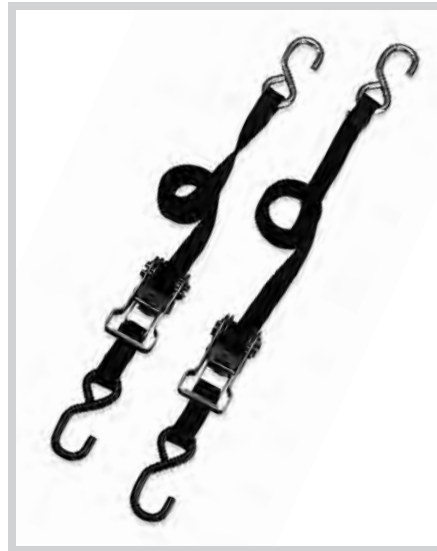

F. ANCRA RAT-PACK RATCHET STYLE TIE-DOWN STRAPS



G. SECURITY ANCHOR

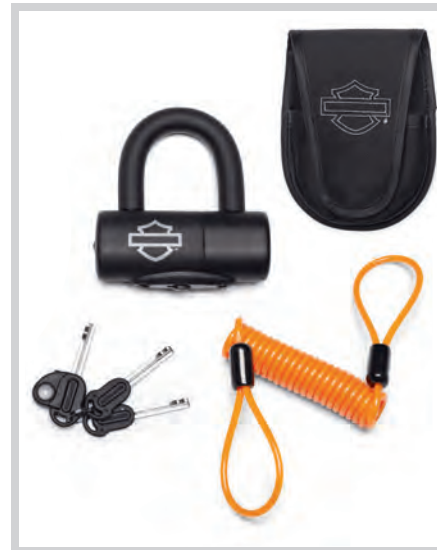

H. DISC BRAKE & ROTOR LOCK*

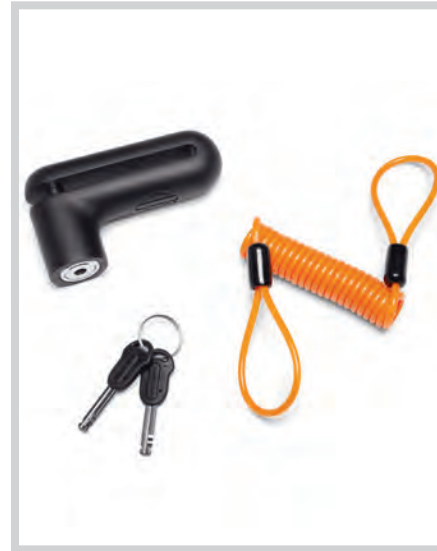

J. DISC BRAKE LOCK*



G. SECURITY ANCHOR INSTALLATION KIT



I. SIREN DISC BRAKE LOCK



K. LOOP CHAIN AND DISC BRAKE & ROTOR LOCK*

GARAGE 707

Motorcycle Locks

G. SECURITY ANCHOR

Lock down that motorcycle. This rugged Security Anchor is designed to create a permanent anchor point for use with security chains and locks. Secure it to your truck or trailer bed or to a garage floor. Includes masonry drill bit and bolts necessary to install into concrete. Corrosion resistant. Recommended to be used with Harley-Davidson® chains and locks, such as Loop Chain and Disc Brake & Rotor Lock (P/N 94869-10A). Recommended to be used with Harley-Davidson Security Anchor Installation Kit (P/N 12600354) for use on trailers or truck beds.

92800013 **\$83.95**

Also available:

SECURITY ANCHOR INSTALLATION KIT

Required for installation of the Harley-Davidson Security Anchor (P/N 92800013) to a trailer or truck bed. For security use only, not to be used as a tie-down point

12600354 **\$22.95**

H. DISC BRAKE & ROTOR LOCK*

Secure your brake disc or sprocket. This lock features a fully removable 14mm lock with a large inside diameter to simplify the capture of chain links and cable loops. High-security double deadbolt design and tough-defeat lock cylinder. Soft vinyl coating on the lock protects your bike's finish. Corrosion resistant. Includes two standard keys, one lighted key, high visibility reminder cord, and a compact ballistic nylon storage pouch with belt clip. Limited lifetime manufacturer warranty*.

94868-10A Black. **\$63.95**

Also available:

LOCK REMINDER CORD¹

Remember to remove your Disc or Fork Lock before beginning your ride with this high-visibility Reminder Cord. Flexible, coiled, bright orange cord loops from external lock to handlebar, acting as a visual indication that your lock is still engaged.

46318-04 **\$5.95**

I. SIREN DISC BRAKE LOCK

Designed to discourage roll-away theft, this rugged lock easily attaches to your disc brake and sounds a piercing alarm if the motorcycle is moved. Physical movement triggers a piercing 120dB audible alarm that acts as an additional theft deterrent. Audible alarm can be deactivated by key if only mechanical security is desired. 0.23 in (6 mm) diameter hardened-steel locking pin. Corrosion resistant. Includes two keys, high visibility reminder cord, and Lithium (CR2) battery. Limited lifetime manufacturer warranty; 2-year battery warranty *

92800012 **\$68.95**

J. DISC BRAKE LOCK*

Designed to discourage roll-away theft, this lock easily attaches to your disc brake. Compact and lightweight so it's easy to carry along in luggage or backpack. Easy to install on the front brake disc. Hardened drop-forged steel lock features a dual-reinforced high-security disc-style cylinder. Corrosion resistant. Includes two keys and high-visibility reminder cord.

94873-10A Black. **\$53.95**

K. LOOP CHAIN AND DISC BRAKE & ROTOR LOCK*

Maximum protection for your motorcycle. This high-security Loop Chain features a 12mm triple heat treated boron manganese 6-sided link steel chain with cinch ring for securing your bike to stationary objects. Loop chain length: 4.25 ft (129 cm). Fully removable Disc Brake & Rotor Lock has a high-security double deadbolt design and tough-defeat lock cylinder, with a soft vinyl coating on the lock to protect your bike's finish. Corrosion resistant. Includes a fully removable 14mm lock, a double deadbolt design for added security, a high-security lock cylinder with anti-float discs and nylon molded dust cover, and a lighted key for nighttime locking. Limited lifetime manufacturer warranty*.

94869-10A Black. **\$132.95**

! WARNING: Remove lock before operating motorcycle. Failure to remove lock could result in death or serious injury.

*KEY SAFE registration and replacement service is provided by the lock manufacturer. Information is included in the product packaging.

708 GARAGE

Motorcycle Locks

A. DOUBLE LOOPED SECURITY CABLE*

For use with a lock, this vinyl-covered multi-purpose cable can be used to secure your personal items to your motorcycle or solid object. Loop it through the sleeve of your jacket and the strap of your helmet, lock it to the bike, and feel free to walk away unencumbered. 7 ft (213 cm) length x 0.4 in (10mm) thick. Corrosion resistant vinyl coating makes cable easy to handle. Hook-and-loop strap lets you secure the coiled cable for convenient storage. Recommend to be used with a Harley-Davidson® Disc Brake & Rotor Lock (P/N 94868-10A)

94871-10A **\$15.95**

B. ARMORED CABLE LOCK

This tempered steel cable lock features a smooth vinyl cover to protect the frame and wheel from scratches. The braided cable offers improved cut resistance, and the integrated lock features a snap-shut cylinder with quarter-turn key movement. Kit includes 2 blade-style keys. Cable length: 6 ft (183cm). Cable is encased by hardened steel links to provide increased security. Corrosion resistant. Limited lifetime manufacturer warranty*

46089-98B **\$68.95**

C. UNIVERSAL MOUNT HELMET LOCK

Lock your lid. This Universal Helmet Lock secures your helmet through its D-Rings directly to the motorcycle so the helmet can't be dropped or stolen. Easy to use – clicks into the locked position without fumbling with the key while holding the helmet. Mounts to tubes from .875 to 1.25 in diameter, including most handlebars, engine guards or bag guards, so you can select the most-convenient location on your bike. Includes tamper-proof and standard mounting screws so the lock may be permanently or temporarily attached to the motorcycle. Scratch resistant backing won't mar up the motorcycle finish.

.875 to 1.25 diameter tubing.

92800019 Chrome. **\$37.95**

92800020 Black. **\$37.95**

D. RETRACTABLE CABLE LOCK*

This multi-purpose retractable cable easily secures your personal items to your motorcycle or solid object, and is small enough to carry in a pocket or backpack. Slip it through a jacket sleeve or a helmet loop and secure to your bike or a fixed object. 3 ft (90 cm) cable length is long enough to secure many different personal items. Compact, lightweight, and easy to use so you never need to leave it at home. 4-digit resettable combination can be personalized so it's easier to remember. Universal fit

92800018 **\$22.95**

E. HARLEY-DAVIDSON HELMET/JACKET SECURITY CABLE²

This handy cable is a great complement to the Harley-Davidson® Helmet Lock. Slide one end through your jacket sleeve or luggage, hook the loops at the end of the cable onto the Helmet Lock and attach it to your bike. And, if your helmet does not have D-rings, you can pass the cable through your helmet's chin piece, loop the ends through your Helmet Lock and lock it to your bike. Now your jacket, luggage and helmet are locked to your bike. When you're finished, it will recoil back to its original length and will slip easily into your pocket. The cable is made from 3mm thick nickel plated steel cable, is only 4.5 inches (11cm) long when coiled, stretches up to 6ft (180 cm) and has a load capacity of 200 lbs (100 kg).

52200004 **\$15.95**



A. DOUBLE LOOPED SECURITY CABLE*



B. ARMORED CABLE LOCK

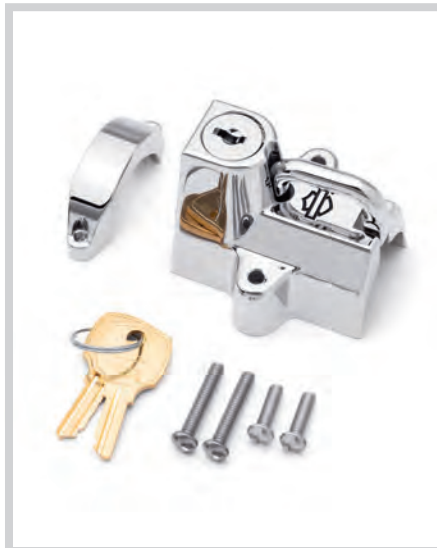

C. UNIVERSAL MOUNT HELMET LOCK – CHROME

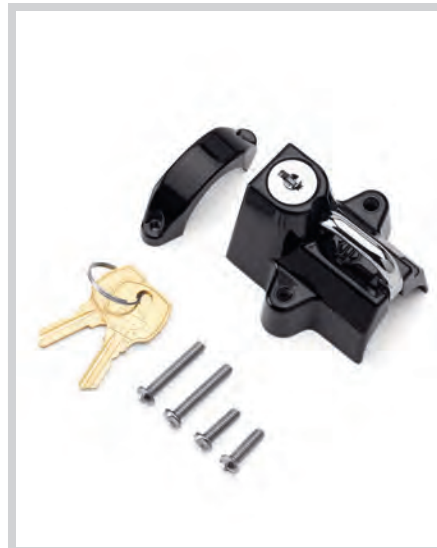

C. UNIVERSAL MOUNT HELMET LOCK – BLACK



D. RETRACTABLE CABLE LOCK*



E. HARLEY-DAVIDSON HELMET/JACKET SECURITY CABLE



F. LOCKING H-D DETACHABLES LATCH KIT – BLACK

KEY SAFE AVAILABLE



G. HOLDFAST LOCKING LATCH – CHROME

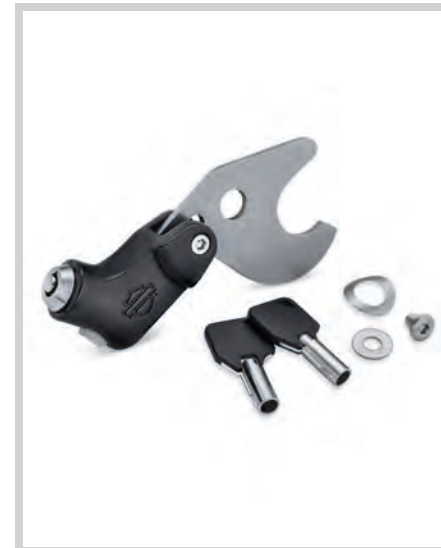

G. HOLDFAST LOCKING LATCH – BLACK



H. UNIVERSAL SADDLEBAG LOCK KIT

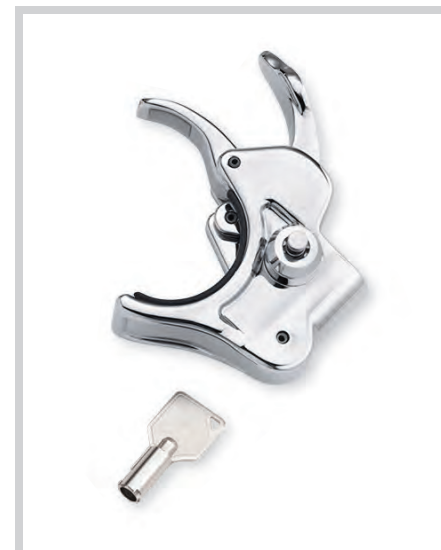

I. LOCKING QUICK-RELEASE WINDSHIELD CLAMP

GARAGE 709

Motorcycle Locks

F. LOCKING H-D® DETACHABLES™ LATCH KIT

This unique lock replaces the cam-lock on your Harley-Davidson® Detachables™ accessories, providing additional security and peace of mind when parking your vehicle. Kit includes two extended-reach barrel-style keys for easy access to the lock. Key registration and replacement service is available. Sold in pairs.

Fits all models equipped with detachable Sideplates, Racks and Tour-Pak® Luggage Carriers (except '18-later Softail® models with HoldFast™ racks and uprights or '09-later Touring models equipped with detachable Solo Tour-Pak Rack).

92800008 Black. **\$78.95**

G. HOLDFAST™ LOCKING LATCH

Secure your valuables. This locking system allows you to protect your HoldFast™ Sissy Bar, Luggage Rack or Tour-Pak Mounting Rack from theft, providing security and peace of mind when parking your vehicle. The kit includes (2) keys and (1) locking mechanism

Fits '18-later Softail models equipped with HoldFast detachable Sissy Bar, Luggage Rack or Solo Tour-Pak Mounting Rack.

52300513 Chrome. **\$59.95**

52300514 Black. **\$59.95**

Fits '18-later FLHC, FLHCS and FLDE models equipped with HoldFast detachable Two-Up Tour-Pak Mounting Rack.

52300518 Chrome. **\$59.95**

52300519 Black. **\$59.95**

H. UNIVERSAL SADDLEBAG LOCK KIT

Keep the contents of your existing soft-sided saddlebags safe from the grab-and-go thief. This unique kit features two extra-small barrel locks that can replace existing saddlebag snaps to perform double duty as locks or as snaps when you don't need to lock your bags. Can be keyed to match your barrel-style ignition key. Sold in pairs.

Fits most soft-sided leather and vinyl saddlebags. Does not fit FLHRC and FLHRS.

90300003 Keyed To Match. **\$64.95**

90300017 Random Key Code. **\$59.95**

I. LOCKING QUICK-RELEASE WINDSHIELD CLAMP

Protect your investment. This Locking Quick-Release Windshield Clamp secures your windshield from grab-and-run theft, giving you peace of mind when you have to leave your bike unattended. The chrome-plated Locking Clamp replaces one of the Original Equipment windshield clamps, and features a push-button lock with a mini barrel-style key for easy removal. Kit includes one locking clamp and two matching keys.

57400536 39mm. **\$82.95**

Fits '88-later XL (except '16-later XL1200CX and XL1200X) and '91-'05 Dyna® models (except FXDWG) equipped with Quick-Release style windshields.



***WARNING:** Chain or cable is to be used as a theft deterrent only. Use for towing, lifting or any other purpose could result in death or serious injury.

***KEY SAFE** registration and replacement service is provided by the lock manufacturer. Information is included in the product packaging.

Notice: The prices appearing in this catalog are the manufacturer's suggested retail prices. Actual retail prices may vary.

Notice: The prices appearing in this catalog are the manufacturer's suggested retail prices. Actual retail prices may vary.

710 GARAGE

Security Systems

A. H-D® SMART SECURITY SYSTEM – '07-LATER MODELS

The H-D® Smart Security System offers automatic self-arming and hands-free disarming for vehicle electronic security functions for your '07-later Harley® motorcycle. The Hands-Free Fob communicates directly on its own unique and individualized frequency with the Hands-Free Security Module and Antenna. Attach the Hands-Free Fob to your vehicle ignition key ring. As you upright your vehicle or switch the ignition on, the Hands-Free Fob will communicate the Security System disarm command allowing you to start your vehicle. After riding your vehicle, park and switch the ignition off with your key. Within 5 seconds the Security System will automatically self-arm, disabling your vehicle starter, ignition and electronic fuel injection (EFI). The Smart Security System includes Hands-Free Security Module (Integrated Security Sensor and Turn Signal Module or Body Control Module), 2 Hands-Free Fobs, Antenna Module, Antenna Harness and Antenna Mount (Dyna® models).

Also available:
H-D SMART SECURITY SYSTEM HANDS-FREE FOB
 Replacement/Additional Hands-Free Fob.

68926-07 \$75.95
 Fits '07-'16 models (except '16 CVO™) equipped with H-D Smart Security System. Requires activation. See your Harley-Davidson® dealer.

90300111 \$76.95
 Fits '17-later XL, Dyna®, Softail®, Touring and Trike models equipped with H-D Smart Security System. Does not fit Japan models. Dealer installation required.

90300117 \$55.95
 Fits '17-'20 XG models equipped with H-D Smart Security System. Requires activation. See your Harley-Davidson dealer.



A. H-D SMART SECURITY SYSTEM – '07-LATER MODELS

B. H-D FACTORY SECURITY SYSTEM – '06-EARLIER MODELS

Equip your '06-earlier Harley-Davidson® VRSC™, Sportster®, Dyna, Softail or Touring model with the security system designed and approved by The Harley-Davidson Motor Company.

When armed, the Security System disables the starter and ignition while monitoring the electrical system and vehicle motion with adjustable sensitivity. Minor disturbances trigger a momentary warning; major ones, an unbroken thirty-second alarm, after which the Security System returns to monitoring. A distinctive four-way flasher pattern is the alarm signal. An optional self-powered Smart Siren Kit adds a piercing scream that sounds even if the battery cable is cut.

The Security System is armed and disarmed with a remote control waterproof key fob utilizing state-of-the-art rolling code technology. If the key fob is not available, the rider may arm or disarm the system by keying a previously entered personal code on the turn signal switches. Kit includes 1 Key Fob.

Also available:
REPLACEMENT/ADDITIONAL REMOTE CONTROL WATERPROOF KEY FOB

68926-00 \$54.95
 Fits '00-'06 models equipped with H-D Factory Security System, North America. Requires activation. See your Harley-Davidson dealer.

68927-00 \$54.95
 Fits '00-'06 models equipped with H-D Factory Security System, International (except Japan). Requires activation. See your Harley-Davidson dealer.

Also available:
LITHIUM REPLACEMENT BATTERY – 3 VOLT

Long-lasting, replaceable lithium coin-type battery for use in LED Temperature Dipsticks with Lighted LED Readout, Digital Touring Suspension Air Pump P/N 54000033 and Security Hands-Free Key Fob.

66000107 \$4.95
 CR2032 3V Lithium Replacement Battery.



A. H-D SMART SECURITY SYSTEM – '07-LATER MODELS (41000021G & 41000087F SHOWN)



A. H-D SMART SECURITY SYSTEM – '07-LATER MODELS (68200-07A, 68207-07A & 91684-08A SHOWN)



B. H-D FACTORY SECURITY SYSTEM – '06-EARLIER MODELS (68200-00D & 68207-00D SHOWN)

GARAGE 711

Security Systems

C. H-D® SECURITY SYSTEM SMART SIREN II

If your bike is equipped with an Original Equipment or accessory H-D® Smart Security System, this Smart Siren provides added security and convenience in one. The Harley-Davidson® Smart Siren II combines the functionality of the smart siren and pager transmitter into one easy-to-install unit. Featuring a built-in back-up power supply, the siren and transmitter functions will continue to operate even if the wires are cut or the vehicle battery is disconnected. When combined with the Pager Receiver II (sold separately), the integrated FM transmitter can warn of tampering up to 1/2 mile away. Smart Siren II features an enhanced sound chamber, a redesigned internal battery access cover and ultra-low power consumption during the standby mode. When activated, the Security System Fob arm and disarm commands are confirmed with a blink feature and '07-later models can be programmed to emit a chirp. Smart Siren II is certified for use in North America.

Also available:
SMART SIREN BATTERY REPLACEMENT KIT (not shown)
 Replacement Battery Kit for Harley-Davidson Factory Security System Smart Siren includes replacement nickel metal hydride battery and instructions.

69309-10 \$54.95



C. H-D SECURITY SYSTEM SMART SIREN II

Notice: The prices appearing in this catalog are the manufacturer's suggested retail prices. Actual retail prices may vary.

H-D SECURITY SYSTEMS, NORTH AMERICA

Model Family	Model Year	Security System		Smart Siren II Kit**	
VRSC™ (except VRSCF)	2007-2017	68207-07A	\$362.95	68328-06A	\$100.95
VRSCF	2009-2017	91684-08A	\$362.95	68328-06A	\$100.95
VRSC (except VRSCR)	2002-2006	68200-00D	\$302.95	68328-06A	\$100.95
VRSCR	2006	68207-00D	\$302.95	68328-06A	\$100.95
Trike	2009-2013	68200-07A	\$362.95	68328-06A	\$100.95
Touring and Trike	2014-later	41000087F	\$382.95	68328-06A	\$100.95
Touring	2007-2013	68200-07A*	\$362.95	68328-06A	\$100.95
Touring	2002-2006	68200-00D*	\$302.95	68328-06A	\$100.95
Touring	2000-2001	68200-00D*	\$302.95	68317-06A	\$141.95
Dyna®	2012-2017	41000087F	\$382.95	68328-06A	\$100.95
Dyna	2007-2011	68207-07A	\$362.95	68328-06A	\$100.95
Dyna	2004-2006	68207-00D	\$302.95	68328-06A	\$100.95
Dyna	2000-2003	68200-00D	\$302.95	—	—
Softail®	2011-later	41000021G	\$382.95	68328-06A	\$100.95
Softail (except FXCW/C)	2007-2010	68207-07A	\$362.95	68328-06A	\$100.95
Softail FXCW/C	2008-2010	91684-08A	\$362.95	68328-06A	\$100.95
Softail	2003-2006	68207-00D	\$302.95	68328-06A	\$100.95
Softail	2001-2002	68207-00D	\$302.95	—	—
XL	2014-later	41000087F	\$382.95	68328-06A	\$100.95
XL/XR	2007-2013	68200-07A	\$362.95	68328-06A	\$100.95
XL	2004-2006	68200-00D	\$302.95	68328-06A	\$100.95

*P/N 88115-03 Bank Angle Switch Kit (sold separately) or Security System P/N 68200-00D or 68200-07A are required for use on 2000-2013 FL Touring models equipped with a TLE/Ultra Sidecar.

**Pager function requires Remote Pager Receiver II P/N 91660-06 or 91672-07 (sold separately).

***'17-later XG models require separate purchase of siren mounting bracket P/N 69201473.

Notice: The prices appearing in this catalog are the manufacturer's suggested retail prices. Actual retail prices may vary.

712 GARAGE

Security & Keys

A. INTEGRATED SECURITY & LOCKING FLIP FOB

This hands-free fob automatically arms and disarms its electronic security functions as you approach and walk away from the bike. Keyed to match all your bike's locks, the combination fob with fold-away retractable barrel key lets you save room on your key ring and let one device do all the work.

90300118 **\$178.95**

Fits '17 Dyna® and Softail®, and '17-later Touring and Trike models equipped with H-D® Smart Security System. Does not fit Japan models. Key code required when ordering. Dealer installation required.



A. INTEGRATED SECURITY & LOCKING FLIP FOB

B. KEYED-TO-MATCH INDIVIDUAL REPLACEMENT LOCK PROGRAM

In the past, replacing a lock required the time and expense of re-keying a new lock or replacing all of the locks on your bike. Our Keyed-to-Match Program eliminates that hassle and allows you to order an exact replacement based on your lock's key code, right down to the quality you would expect from a stock Harley-Davidson® lock. Just ask your Dealer to refer to Bulletin Number 658B and they'll take care of your needs – lock, stock and barrel.

C. KEYED-TO-MATCH CUSTOM KEYS

Custom keys make a statement. Keys can be ordered through your Harley-Davidson® Dealer and will be keyed to match your ignition and fork lock and they are delivered in a leatherette gift box.

1. Commemorative CVO™ Model Ignition Key

Hand-polished brass key features a prismatic Bar & Shield logo set in a black field surrounded by Custom Vehicle Operations script. Available to CVO™ vehicle owners only.

71031-04 Barrel Style. **\$95.95**

Fits '91-later models with barrel-style key.

2. Skull Ignition Keys

Key features the Harley-Davidson Skull logo in bright nickel with black accents.

71040-04 Barrel Style. **\$83.95**

Fits '91-later models with barrel-style key.



A. INTEGRATED SECURITY & LOCKING FLIP FOB



B. KEYED-TO-MATCH INDIVIDUAL REPLACEMENT LOCK

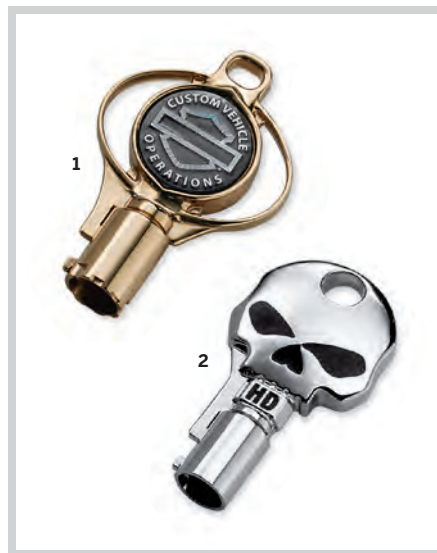

C. KEYED-TO-MATCH CUSTOM KEYS



D. HARLEY-DAVIDSON SECURITY SYSTEM PAGER RECEIVER II – BATTERY POWERED



E. HARLEY-DAVIDSON SECURITY SYSTEM PAGER RECEIVER II – RECHARGEABLE



F. COTTON WINDSHIELD STORAGE BAG



G. HELMET HANGER – J-HOOK



H. JIFFY STAND COASTER

GARAGE 713

Security

HARLEY-DAVIDSON® SECURITY SYSTEM PAGER RECEIVER II

Designed to complement the Smart Siren II, this Pager Receiver can be linked to the vehicle with no additional installation. The Pager Receiver II monitors the Security System operation, and features multi-color LED indicators to display unique codes for arming, disarming and trigger modes. The Range Confirmation Signal (RCS) confirms and displays the signal reception. High-efficiency FM circuitry provides excellent reception, even in buildings and parking garages. Maximum effective range is up to 1/2 mile. The Pager Receiver II features selectable vibration or audible modes. The silent paging mode feature allows selectable programming trigger modes to avoid activating the siren.

D. PAGER RECEIVER II – BATTERY POWERED

The convenient built-in ultra-bright white LED flashlight helps light the way. The compact, lightweight receiver can be carried in your pocket, or the receiver holster can be clipped to a belt up to 1-3/4 wide. Kit includes receiver, holster and one 3V lithium battery. Operates in conjunction with the Security System Fob and Smart Siren II.

91660-06 **\$79.95**

Fits all models equipped with the Harley-Davidson® Security System Smart Siren II. Certified for use in North America.

E. PAGER RECEIVER II – RECHARGEABLE

The compact, lightweight receiver can be carried in your pocket or clipped to a belt. Kit includes receiver and UL-listed battery charger (AC-DC with output of DC 4.5V 50mA for North America). Operates in conjunction with the Security System Fob and Smart Siren II.

91672-07 **\$95.95**

Fits all models equipped with the Harley-Davidson Security System Smart Siren II. Certified for use in North America.

F. COTTON WINDSHIELD STORAGE BAG

This bag is constructed of breathable cotton material and is designed for a scratch-free storage area. The outside of the bag features an embroidered Bar & Shield logo to match the cotton cycle covers.

95982-98B **\$74.95**

Fits all Harley-Davidson® windshields.

G. HELMET HANGER

Proudly display your collection of helmets. Harley-Davidson® Helmet Hangers keep your expensive helmet safe and out of the way. Designed to accommodate all types of helmets, these Helmet Hangers allow air to circulate inside to keep the liner fresh and dry. The rigid steel hooks feature a durable e-coated surface and soft rubber edges to protect the finish of the helmet. The wall-mount J-Hook design can be secured to a trailer wall, garage wall or most any flat surface. The universal S-Hook design hangs on doors, cubicle walls and closet rods.

93100034 J-Hook. **\$33.95**

H. JIFFY STAND COASTER

Designed for use beneath the jiffy stand, this polypropylene coaster prevents the stand from sinking into soft surfaces such as dirt, asphalt and grass.

94647-98 **\$6.95**

Fits motorcycles equipped with a sidestand.

Notice: The prices appearing in this catalog are the manufacturer's suggested retail prices. Actual retail prices may vary.

Notice: The prices appearing in this catalog are the manufacturer's suggested retail prices. Actual retail prices may vary.

H-D® BATTERY CHARGERS

These new H-D® chargers are designed to do more than just charge your H-D® motorcycle battery. These chargers will effortlessly charge multiple battery voltages (6 and 12 volt) with chemistries such as flooded, gel, AGM and Lithium. You can also charge different types of batteries such as deep-cycle, marine, powersport and more. The chargers are completely automatic. You can leave these chargers plugged in 24/7 with no worries of overcharging. Best of all there is no technical knowledge required. Chargers are designed for use in any climate, altering each charge based on the ambient temperature and providing a more accurate recharge.

Additional Features

SMART INDICATORS

H-D Chargers have smart indicators and diagnostics to quickly detect when the battery charger is connected in reverse polarity, connected to an incompatible battery, or if the battery is failing. These Chargers provide simple troubleshooting using advanced diagnostics









- Battery Failure
- Reverse Polarity
- High Voltage
- Standby

ERROR CONDITIONS PROVIDED

- Battery Below Start Voltage
- Reverse Polarity
- Battery Will Not Hold Charge
- Bulk Charge Timeout
- Battery Above Protection Voltage
- Charger Internal Temperature Too High
- Charger Ambient Temperature Too Cold

BRING BATTERIES BACK TO LIFE

- Auto Desulfation mode
- Auto Detection mode
- Auto Repair mode

	SMART INDICATORS	ERROR CONDITIONS PROVIDED	BRING BATTERIES BACK TO LIFE
1AH DUAL-MODE			
2AH DUAL-MODE			
5AH DUAL-MODE			



A. 1 AMP DUAL-MODE BATTERY CHARGER



B. 2.0 AMP DUAL-MODE BATTERY CHARGING STATION



C. 5.0 AMP DUAL-MODE BATTERY CHARGER

A. 1 AMP DUAL-MODE BATTERY CHARGER

This fully-automatic Harley-Davidson® Dual-Mode Battery Charger is ideal for short- or long-term motorcycle battery charging needs. Selectable charge options provide optimal charging for Harley-Davidson™ Lithium LiFe or AGM Lead-Acid batteries. Can be used to charge 12 volt and 6 volt batteries. Can be used with existing Harley-Davidson™ battery charging cords - no additional charging cords needed. Maximum charge rate of 1 amp. Harley-Davidson tested and validated. Backed by a 5-year limited warranty.

- 66000304** \$54.95
For use within the United States, Canada, Mexico and South America
- 66000308** \$54.95
For use within Europe, Middle East and Asia
- 66000305** \$54.95
For use within the United Kingdom
- 66000307** \$54.95
For use within Australia
- 66000306** \$54.95
For use within Japan

B. 2.0 AMP DUAL-MODE BATTERY CHARGING STATION

Keep all your bikes fully charged and ready to ride. This fully-automatic 4-bank Harley-Davidson® Dual-Mode Battery Charger is perfect for short- or long-term motorcycle battery charging needs. 4-bank charging station can charge and maintain up to 4 batteries at once. Selectable charge options provide optimal charging for Harley-Davidson™ Lithium LiFe or AGM Lead-Acid batteries. Can be used to charge 12 volt and 6 volt batteries. Can be used with existing Harley-Davidson™ battery charging cords - no additional charging cords needed. Maximum charge rate of 2 amp. Harley-Davidson tested and validated. Backed by a 5-year limited warranty.

- 66000319** \$270.95

C. 5.0 AMP DUAL-MODE BATTERY CHARGER

This fully-automatic Harley-Davidson® Dual-Mode Battery Charger is perfect for short- or long-term motorcycle battery charging needs. Selectable charge options provide optimal charging for Harley-Davidson™ Lithium LiFe or AGM Lead-Acid batteries. Can be used to charge 12 volt and 6 volt batteries. Can be used with existing Harley-Davidson™ battery charging cords - no additional charging cords needed. Features repair mode for AGM batteries. Maximum charge rate of 5.0 amp. Harley-Davidson tested and validated. Backed by a 5-year limited warranty.

- 66000309** \$113.95
For use within the United States, Canada, Mexico and South America
- 66000313** \$113.95
For use within Europe, Middle East and Asia
- 66000310** \$113.95
For use within the United Kingdom
- 66000312** \$113.95
For use within Australia

Notice: The prices appearing in this catalog are the manufacturer's suggested retail prices. Actual retail prices may vary.

716 GARAGE

Charging Accessories

A. HOG® BOOSTER PORTABLE BATTERY PACK

Think of it as a kick start for your weak battery. This lightweight, compact lithium powered battery pack is ready and waiting to jolt your battery back to life. Small enough to fit in your saddlebag or backpack, this 1000 amp portable battery pack will restart your motorcycle in seconds. The HOG® Booster easily connects to your motorcycle battery with high-quality alligator clips, and the sparkproof and reverse polarity protected connections help protect your bike's electrical system.

The HOG Booster's internal lithium battery can be recharged anywhere—from a wall outlet using your cell phone charging block, from your computer's USB port or from a 12V power outlet (with the included adaptor). A fully charged HOG Blaster will start up to 20 dead batteries. HOG Booster can also power and charge USB devices like cell phones and cameras to keep you in touch while on the road. The HOG Blaster also features a built-in 100 lumen flashlight with high, low and strobing SOS modes so you have a light source when you need it.

Complete kit includes HOG Booster unit, high-quality alligator clips and cables, 12V/cigarette lighter adaptor, handy storage bag and easy-to-read instruction manual.



A. HOG BOOSTER PORTABLE BATTERY PACK



Technical Data:

Internal Battery = Lithium Ion

Peak Current Rating = 1000A

Joules = 7000J

Micro USB (Input) = 5V, 2.1A

USB (output) = 5V, 2.1A

Weight = 2.4 lbs.

Flashlight Lumens = 100

USB Charger Rating = .5A–12 hrs; 1A–6 hrs; 2A–3 hrs.

66000130	For US and Canada markets.	\$139.95
66000147	For Europe, Middle East, Africa, Asia Pacific markets.	\$139.95

B. BATTERY BOOSTER TRAVEL CASE

This durable and rugged case will make it easy to transport and protect your Harley-Davidson Booster Portable Battery Pack (high-quality alligator clips and cables, 12V/Cigarette lighter adaptor and USB cable) wherever your travels will take you.

Designed for Booster Portable Battery Pack P/N 66000130 or 66000147 (sold separately).

66000347	\$21.95
-----------------	----------------



B. BATTERY BOOSTER TRAVEL CASE



C. BATTERY CHARGING HARNESS WITH LED CHARGE INDICATOR

C. BATTERY CHARGING HARNESS WITH LED CHARGE INDICATOR

This Battery Charging Harness features an integrated LED indicator light that illuminates when your battery voltage drops to a level that requires charging. Just attach the ring terminals to your battery and route the harness for easy access to the plug connector. When the LED glows, it's time to connect the bike to a Harley-Davidson® Battery Charger. Compatible with all Harley-Davidson Battery Chargers, the harness features in-line 7.5 amp fuse protection, and the plug connector is protected with a weather-shield cap when not in use.

66000005	\$17.95
For use with Harley-Davidson 12-volt batteries.	

D. BATTERY CHARGING HARNESS

Heavy-duty Battery Charging Harness with ring terminals and in-line 7.5 amp fuse protection for attachment to a Harley-Davidson 12-volt battery. The wiring harness utilizes a plug connector that is compatible with all Harley-Davidson Battery Chargers equipped with black connectors. The ring terminals are attached to the battery with the harness routed to allow access for the plug connector attachment to a H-D® Battery Charger. The harness plug connector is protected with an attached weather-shield cap when not in use.

94624-97B	\$9.95
For use with Harley-Davidson 12-volt batteries.	



D. BATTERY CHARGING HARNESS



E. BATTERY CHARGING EXTENSION LEAD

E. BATTERY CHARGING EXTENSION LEAD

Low-loss leads feature the same quick-disconnect 2-prong plugs as found on the charger unit and the available charging harnesses.

For use with most Harley-Davidson Battery Chargers.

99821-09	12.5'	\$18.95
99828-09	25'	\$23.95

GARAGE 717

Batteries

F. LITHIUM LIFE BATTERIES

Power up with lithium Life battery technology, offering unequalled cranking power and a significant weight reduction over an AGM lead acid battery. Quality and performance backed by a 5-year limited warranty. A drop-in replacement for the Original Equipment battery with no fit adaptor or foam blocks required. Up to twice the life span of AGM lead acid battery*. When disconnected from the motorcycle a lithium battery will maintain its charge without maintenance for up to 12 months. The internal solid-state Battery Management System automatically detects over/under charging for more-reliable starting performance and protects the battery from deep discharge, over voltage and over temperature. For optimal charging, use a Harley-Davidson® Dual Mode Battery Charger (sold separately).

*Follow storage instructions for optimal service life

Note: Lithium batteries are not for everyone as they differ from AGM in terms of powering certain accessories or bikes that have been heavily modified from stock configurations. Be sure to ask your H-D® dealer if a Lithium battery is right for your application and use.

66000301	4AH	\$181.95
Fits '15-later XG, '04-later XL and '08-'13 XR models.		
66000302	7AH	\$269.95
Fits '07-'17 VRSC™ (except '07 VRSCR), '97-'03 XL, '97-'17 Dyna®, '97-later Softail® models.		
66000303	8AH	\$299.95
Fits '04-later Touring and '09-later Trike models		

G. H-D® AGM BATTERIES

Fits '07-'17 VRSC (except '07 VRSCR), '97-'03 XL, and '97-'17 Dyna and '97-later Softail models. Also fits Buell™ S1, S3/T, M2, and X1 models.

65989-97E	Dual (Top and Side) Terminal Design.	\$145.95
66000207A	International.	

Fits '97-later Touring and '09-later Trike models.

66010-97E	Dual (Top and Side) Terminal Design.	\$185.95
66000212A	International.	

Fits '15-later XG, '04-later XL and '08-'12 XR models. Also fits Buell 1125R/CR models.

65958-04C	Dual (Top and Side) Terminal Design.	\$125.95
66000208A	International.	

Fits '02-'06 VRSC and '07 VRSCR models. Also fits Buell XB and Blast models.

65948-00C		\$121.95
66000206A	International.	

Fits '77-'78 XLCR, '79-'96 XL, '73-'94 electric start FX and FXR, '99-'00 FXR and '84-'90 Softail models. Replaces P/Ns 65991-82A and 65991-75C. Also fits Buell S2/T Thunderbolt™ models.

65991-82B		\$141.95
66000209	International.	

Fits '80-'96 FLHR, FLHT and FLT Touring models.

66010-82B		\$156.95
66000210	International.	

Fits '91-'96 Dyna and Softail models

65989-90B		\$141.95
66000211	International.	

NOTE: Battery dimensions of Harley-Davidson AGM Batteries P/N 65989-97C, 65989-90B and 65991-82B may not allow use of accessory side covers on XL and Dyna models.

CONVENTIONAL BATTERIES* (not shown)

66006-29F	6V.	\$89.95
Fits '64-earlier FL and '63-earlier GE models.		

Also available:

H-D® ELECTRICAL CONTACT LUBRICANT (not shown) Ideal for use on multi-pin connectors, bulb bases and battery terminals, this specially formulated Electrical Contact Lubricant offers excellent film strength that is resistant to water (including salt water). Safe for use on tin, nickel, copper, brass, gold and silver contacts, and the formula is compatible with electrical connector plastics and elastomers.

11300004	1 oz (28 g) Tube.	\$15.95
-----------------	-------------------	----------------



F. LITHIUM LIFE BATTERIES



G. H-D AGM BATTERIES

Motorcycle batteries built and rigorously tested to Harley-Davidson's exacting requirements. H-D® AGM battery ratings are determined by the strict regulations and testing of the Battery Council International.

! WARNING: Battery posts, terminals and related accessories contain lead compounds, chemicals known to the State of California to cause cancer and birth defects.

Notice: The prices appearing in this catalog are the manufacturer's suggested retail prices. Actual retail prices may vary.

Notice: The prices appearing in this catalog are the manufacturer's suggested retail prices. Actual retail prices may vary.

718 GARAGE

Tools

A. ALL-IN-ONE FOLDING TOOL

This kit is the ideal traveling companion. This compact folding tool is equipped to perform the basic on-the-road service functions on most late-model Harley-Davidson® motorcycles. Large comfortable handle with a soft grip adds leverage, and holds the foldaway tools. Tool selection: Torx® bits – T27, T40; Hex Bits – 3/32, 1/4, 3/8; Screwdriver Bits – Phillips, slotted; Open end wrenches (2) – 9/16, 1/2, 10mm. Kit includes nylon pouch with hook-and-loop closure and Bar & Shield logo.

94435-10 **\$48.95**
Fits '02-later models (except VRSC™, XG RA1250 and RA1250S models).

B. 8-IN-1 SCREWDRIVER

Ideal tool for most of the screws on H-D® products. The unique 8-in-1 design conveniently stores all fittings within handle. Included are #40, 30, 27 and 25 Torx, #2 and 3 Phillips and 2 slotted driver bits. Quality engineered by Snap-On® with lifetime guarantee against breakage.

94669-00 **\$24.95**

C. COMBINATION AXLE WRENCH

Individual combination front and rear axle wrenches available for your model.

94697-08 .9375 & 36mm. **\$20.95**
Fits '08-'17 Dyna®, '08-later Softail® and Touring models.

D. SHOCK ADJUSTMENT SPANNER

The Universal Spanner is small enough to carry in a H-D Tool Kit, and is designed to adjust the spring load on all mechanically adjustable H-D rear shock absorbers.

94448-82B **\$15.95**
For use on models with mechanically adjustable H-D rear shock absorbers. Does not fit XG500, XG750, XR, '16-later XL, XL models equipped with Premium Emulsion Shocks P/N 54000076, 54000077 or Dyna models with Premium Emulsion Shocks P/N 54000066.

E. BELT TENSION TESTER TOOL

Use to check tension on secondary belt.

40006-85 **\$38.95**

F. STAINLESS STEEL TRAYS WITH MAGNETIC BASE

Convenient storage tray with a magnetic base secures small metallic parts during maintenance. Use it horizontally, vertically or upside down. The magnetic base is covered with a protective coating to prevent damage to surface finishes.

94793-01 6 Diameter. **\$14.95**



A. ALL-IN-ONE FOLDING TOOL



B. 8-IN-1 SCREWDRIVER



C. COMBINATION AXLE WRENCH



D. SHOCK ADJUSTMENT SPANNER



E. BELT TENSION TESTER TOOL



F. STAINLESS STEEL TRAYS WITH MAGNETIC BASE

GARAGE 719

Tools

G. HARLEY-DAVIDSON® PREMIUM TOOL KIT

This Premium Harley-Davidson® branded Tool Kit features all the tools you need for common maintenance on your motorcycle. The heavy-duty tools are conveniently secured in a hinged carrying case, and lock in place for simple organization. Tools feature large, easy-to-read size indicators, and are stamped with the classic Harley-Davidson script. Lifetime warranty.

64-Piece Kit includes:

- 1 – Quick-Release Ratchet (3/8 Drive)
- 1 – 3 Extension (3/8 Drive)
- 1 – 6 Extension (3/8 Drive)
- 1 – Universal Joint (3/8 Drive)
- 11 – SAE Deep Sockets 3/8 – 1 (3/8 Drive)
- 8 – Metric Deep Sockets 10mm – 17mm (3/8 Drive)
- 1 – Spark Plug Socket 5/8 (3/8 Drive)
- 6 – Hex Sockets 1/8 – 3/8 (3/8 Drive)
- 6 – Torx® Sockets T25-T50 (3/8 Drive)
- 2 – Spinner Handle (1/4 Drive) with Adaptor
- 6 – Bits (Slotted, Phillips, Torx)
- 9 – SAE Combination Wrenches 1/4 – 3/4
- 8 – Metric Combination Wrenches 8mm – 17mm
- 1 – Diagonal Pliers – 7
- 1 – Slip Joint Pliers – 8
- 1 – Needle Nose Pliers – 8

14900033 **\$292.95**

H. HARLEY-DAVIDSON/SNAP-ON® TOOL KITS

These tool kits were developed specifically for Harley-Davidson by Snap-On® to perform the most functions with the least amount of tools and weight. Provides all the right tools, without compromising quality or damaging your motorcycle's hardware. Lifetime warranty.

H-D®/Snap-On Compact Tool Kit

Designed to provide the most tools in the least amount of space, this tool kit rolls into a compact pouch for easy transport.

94684-00A **\$235.95**
For use with '00-later models (except VRSC™, XG and FXR4).

I. HARLEY-DAVIDSON TOOL KIT

This is the ideal carry-along tool kit for your Harley-Davidson motorcycle. The kit was developed to perform most service functions and weigh as little as possible to keep your load light.

94819-02 **\$90.95**
For use with '86-later XL, '08-'13 XR, '99-'17 Dyna®, and '99-later Softail, Touring, and Trike models.

J. TOOL KIT FOR PAN AMERICA® MODELS

Provides tools necessary for external service and maintenance of your vehicle.

14900127 **\$160.95**
For use with '21-later Revolution® Max equipped models.



G. HARLEY-DAVIDSON PREMIUM TOOL KIT



H. H-D/SNAP-ON COMPACT TOOL KIT ('00-LATER MODELS SHOWN)



I. HARLEY-DAVIDSON TOOL KIT



J. TOOL KIT FOR PAN AMERICA MODELS

Notice: The prices appearing in this catalog are the manufacturer's suggested retail prices. Actual retail prices may vary.

Notice: The prices appearing in this catalog are the manufacturer's suggested retail prices. Actual retail prices may vary.

720 GARAGE

Air Filters

A. HARLEY-DAVIDSON® ORIGINAL EQUIPMENT AIR FILTER ELEMENTS

Late-model pleated paper type elements with aluminum back plates.

29400078 **\$29.95**

Fits '15-'20 XG models (except XG750A).

29331-04 **\$36.95**

Fits '04-'13 XL models with oval air cleaner assembly.

29400015 **\$30.95**

Fits '14-later XL models with round air cleaner cover.

29377-08 Fits '08-'12 XR models. **\$30.95**

29437-01A Fits '02-'17 VRSC™ models. **\$48.95**

29400042 **\$30.95**

Fits '99-'06 carbureted Twin Cam equipped models, '01-'15

EFI Softail® (except '08-'11 FLSTSB, '11-later FXS, '12-later

FLS and '13-later FXDB) and '02-'07 EFI Touring and Dyna®

models.

29633-08 Fits '08-'13 Touring and Trike models. **\$30.95**

29400267 **\$47.95**

Fits '18-later FLFBS, FLHCS, FXBRS and FXFBS and '17-later

CVO™ Touring models with Milwaukee-Eight® engine and

ventilator air cleaner.

29400248 **\$23.95**

Fits '18-later Softail® models (except FLFBS, FLHCS, FXBBS,

FXBRS, FXFBS and FXLRS).

29400045 **\$22.95**

Fits '16-'17 Softail (except FLSTFBS) and '14-'16 Touring and

Trike models.

29400212 **\$23.95**

Fits '17-later Touring and Trike models with Milwaukee-Eight

engine and wedge-shaped air cleaner.

29191-08 **\$30.95**

Fits '08-'15 Dyna models with teardrop air cleaner.

29314-08 **\$31.95**

Fits '13-later FXDB, '12-'15 FLS, '08-'11 FLSTSB and '11-'13

FXS models.

29509-06 Fits '06-'10 FLHTCUSE models. **\$31.95**

29462-99 **\$31.95**

Fits '99-'01 EFI Twin Cam models (except '01 Softail).

29291-95 **\$31.95**

Fits '95-'99 Evolution® 1340 equipped models with electronic

fuel injection (EFI).

29259-91A **\$30.95**

Fits '91-'95 Evolution 1340-equipped Dyna, FXR, Softail, and

Touring models.

29331-96 **\$31.95**

Fits '88-'03 Evolution XL models.

29325-95A **\$30.95**

Fits '95-'03 Evolution XL and 1340 models. (International

models only. See your Dealer.)

B. SCREAMIN' EAGLE® AIR FILTERS

1. SCREAMIN' EAGLE HIGH-FLOW AIR FILTER – ROUND

This washable and reusable filter is a direct replacement for the original equipment filter and provides the same air flow performance as the original equipment.

29400428 **\$83.95**

Fits '21-later RA1250, RA1250S and RH1250S models.

2. SCREAMIN' EAGLE HIGH-FLOW AIR FILTER – HOMEPLATE

This washable and reusable filter provides 5 percent more air flow to the engine compared to the original equipment filter.

29400426 **\$84.95**

Fits '21-later RA1250, RA1250S and RH1250S models.

3. SCREAMIN' EAGLE EXTREME-FLOW AIR FILTER – PAN AMERICA®

This washable and reusable filter is specifically designed for off-road environments with off-road specific filter media. Provides 9 percent more air flow to the engine compared to the original equipment filter to allow the engine to breathe in all types of riding conditions. Clean, dry, and re-oil to reuse

29400427 **\$127.95**

Fits '21-later RA1250 and RA1250S models.



A. HARLEY-DAVIDSON ORIGINAL EQUIPMENT AIR FILTER ELEMENTS



A. XR1200 AIR FILTER ELEMENT



A. VRSC AIR FILTER ELEMENT



B. SCREAMIN' EAGLE AIR FILTERS



B. SCREAMIN' EAGLE HIGH-FLO K&N AIR FILTER ELEMENT



B. SCREAMIN' EAGLE HIGH-FLO K&N AIR FILTER ELEMENT – HEAVY BREATHER



B. SCREAMIN' EAGLE HIGH-FLO K&N AIR FILTER ELEMENT – HEAVY BREATHER

GARAGE 721

Air Filters

B. SCREAMIN' EAGLE® HIGH-FLO K&N® AIR FILTER ELEMENT

K&N® replacement air filters are engineered to improve airflow for increased horsepower and quicker acceleration. K&N filters provide excellent filtration, and because they are washable and reusable, you can clean the filter whenever conditions demand. Designed as direct replacements for specified fitments.

NOTE: These washable and rechargeable filters use a special coating to help filter fine particles from the incoming air. With time, the oil in the filter will dissipate and the element will begin to turn gray. Clean the surface and renew the original red color with an application of K&N Air Filter Care products.

1. 29400020 High-Flow–Multi-fit. **\$83.95**
Fits '07-later XL, '99-'07 Dyna®, '00-'15 Softail® and '99-'07 Touring models equipped with High-Flow Air Cleaner Kits. Replacement for P/N 29442-99E.

1. 29400358 High-Flow – Multi-fit. **\$66.95**
Fits '18-later Softail and '17-later Touring and Trike models equipped with round High-Flow Air Cleaner P/N 29400355 or 29400356.

2. 29400021 High-Flow–Dyna. **\$68.95**
Fits '08-'17 Dyna models equipped with High-Flow Air Cleaner Kit. Replacement for P/N 29385-08.

3. 29400019 High-Flow–Touring. **\$73.95**
Fits '16-'17 Softail and '08-'16 Touring and Trike models equipped with High-Flow Air Cleaner Kit. Replacement for P/N 29244-08.

4. 29400247 High-Flow – Wedge. **\$89.95**
Fits '17-later Touring and Trike models equipped with Wedge High-Flow Air Cleaner Kit P/N 29400245 or 29400246.

5. 29400065 Extreme Billet. **\$104.95**
Fits '15-later XG, '16-'17 Softail® and '08-'16 Touring and Trike models equipped with Extreme Billet Agitator and Chisel Air Cleaner Kits.

5. 29400118 Extreme Billet & Rail. **\$104.95**
Fits '07-later XL, '08-'17 Dyna and '08-'15 Softail and models equipped with Extreme Billet Chisel and Agitator or Rail Collection Air Cleaner Kits.

5. 29400359 Extreme. **\$94.95**
Fits '18-later Softail and '17-later Touring and Trike models equipped with round High-Flow Air Cleaner P/N 29400357.

6. 29400109 Burst Collection. **\$66.95**
Fits '08-'17 Dyna and Softail models, '08-'16 Touring and Trike models equipped with Burst Collection Air Cleaner Kits.

7. 2940022A Ventilator–Multi-fit. **\$83.95**
Fits models equipped with Twin-Cam Ventilator and Extreme Billet Ventilator Performance Air Cleaner Kits. Replacement for P/N 29670-09.

8. 29400293 Ventilator. **\$68.95**
Fits '18-later Softail, '17-later Touring and Trike models equipped with Ventilator Air Cleaner P/N 29400298 or 29400299.

9. 29424-05B Heavy Breather–Multi-fit, Chrome. **\$99.95**
Fits models equipped with Heavy Breather Kit P/N 29098-09, 29299-08, 29080-09 or 29264-08.

9. 29702-08B Heavy Breather–Touring, Chrome. **\$99.95**
Fits models equipped with Heavy Breather Kit P/N 29006-09B, 29253-08B, 29000065 or 29400105.

9. 29400297 Heavy Breather–Touring, Black. **\$131.95**
Fits '16-'17 FXDLS and models equipped with Heavy Breather Kit P/N 29006-09B, 29253-08B, 29000065 or 29400105.

10. 28714-10 Heavy Breather–Compact, Chrome. **\$95.95**
Fits '08-'16 Touring and Trike models equipped with Compact Heavy Breather Kit P/N 28716-10A.

11. 29400141 Heavy Breather Elite, Chrome. **\$121.95**
Fits models equipped with Screamin' Eagle® Heavy Breather Elite Performance Air Cleaner Kit P/N 29400172 and 29400173.

11. 27300139 Heavy Breather Elite, Black. **\$132.95**
Fits Replacement air filter for models equipped with Screamin' Eagle Heavy Breather Elite Performance Air Cleaner Kit P/N 29400285.

12. 29400276 Heavy Breather, Black. **\$129.95**
Fits '18-later Softail, '17-later Touring and Trike models equipped with Heavy Breather Air Cleaner P/N 29400263 or 29400264.

13. 29400275 Heavy Breather, Chrome. **\$129.95**
Fits '18-later Softail, '17-later Touring and Trike models equipped with Heavy Breather Air Cleaner P/N 29400263 or 29400264.

Notice: The prices appearing in this catalog are the manufacturer's suggested retail prices. Actual retail prices may vary.

Notice: The prices appearing in this catalog are the manufacturer's suggested retail prices. Actual retail prices may vary.

722 GARAGE

Spark Plugs

A. SCREAMIN' EAGLE® PERFORMANCE SPARK PLUGS

SPARK PLUGS
Screamin' Eagle® Spark Plugs feature double platinum coating for superior erosion resistance and extended life. The V trimmed ground electrode reduces shrouding of the flame front to promote flame propagation, and the fine wire center electrode enhances startups and ignitability. Screamin' Eagle Plugs feature Ribbed Core Technology (RCT) that provides resistance to fouling, and are designed with Original Equipment-style noise suppression to prevent electrical interference with radios and CB communication equipment. Works great in racing applications where rich air/fuel conditions are required. Unique style with Screamin' Eagle logo. Sold in pairs.

Standard Compression Applications

Designed for modified engines including performance carburetors, high-flow air cleaners, camshafts, exhaust systems and ignition systems in conjunction with stock compression ratios.

31600106 Standard Compression Applications. **\$23.95**
Fits '99-'17 Twin Cam-equipped models, and '86-later Evolution® Sportster® 883, 1100 and 1200 models.

31600085 Standard Compression Applications. **\$23.95**
Fits '15-'20 XG models and '17-later Milwaukee-Eight® engine equipped models.

High Compression Applications

These plugs are designed for high-performance applications involving modifications in high-flow air cleaners, camshafts, exhaust, performance heads, ignition components, higher compression ratios above Original Equipment configurations or engines specific for racing applications.

31600105 High Compression Applications. **\$23.95**
Fits '99-'17 Twin Cam-equipped models. '86-later XL and XR and Evolution® 1340 models equipped with Screamin' Eagle Performance Cylinder Heads.

B. HARLEY-DAVIDSON® GOLD SPARK PLUGS

A special thread and shell coating ensures quick and easy removal from aluminum heads and resists corrosion. A gold palladium insert extends life and improves resistance to corrosion. The tapered tip provides better spark exposure to air/fuel mixture and allows the mixture to flow more easily through gap area for maximum combustibility. Fouling resistance is improved with smaller diameter center electrode wire and insulator tip. Plus, a copper-cored ground electrode runs cooler for extended life.

32365-04 (6R12G) **\$7.95 each**
Fits '86-later XL and '99-'17 Twin Cam-equipped models or use in place of No. 6R12.

32367-04 (5R6AG) **\$7.95 each**
Fits later '78-'84 Shovelhead and '84-'99 Evolution 1340-equipped models or use in place of Nos. 5R6A and 5RL.

27794-08 (10R12X) **\$6.95 each**
Fits '08-'12 XR models.

C. HARLEY-DAVIDSON® ORIGINAL EQUIPMENT SPARK PLUGS

32335-04 (10R12A) **\$5.95 each**
Fits '02-'17 VRSC™ models.

31600012 (6R10) **\$5.95 each**
Fits '15-'20 XG models and '17-later Milwaukee-Eight engine equipped models.

32342-04 (5R6A) **\$4.95 each**
Fits later '78-'84 Shovelhead and '84-'99 Evolution 1340-equipped models.

32362-04A (6R12) **\$5.95 each**
Fits '86-later Evolution-equipped XL models and '99-'17 Twin Cam-equipped models.

32338-04 (4R5) Fits '71-'85 Sportster. **\$5.95 each**

32336-04 (4R) **\$4.95 each**
Fits '54-'56 KH, '57-'70 XL-900, '71-'85 Iron Sportster and '48-'74 FX and FLH models.

32337-04 (3-4) Fits '48-'74 FLH/FX. **\$5.95 each**

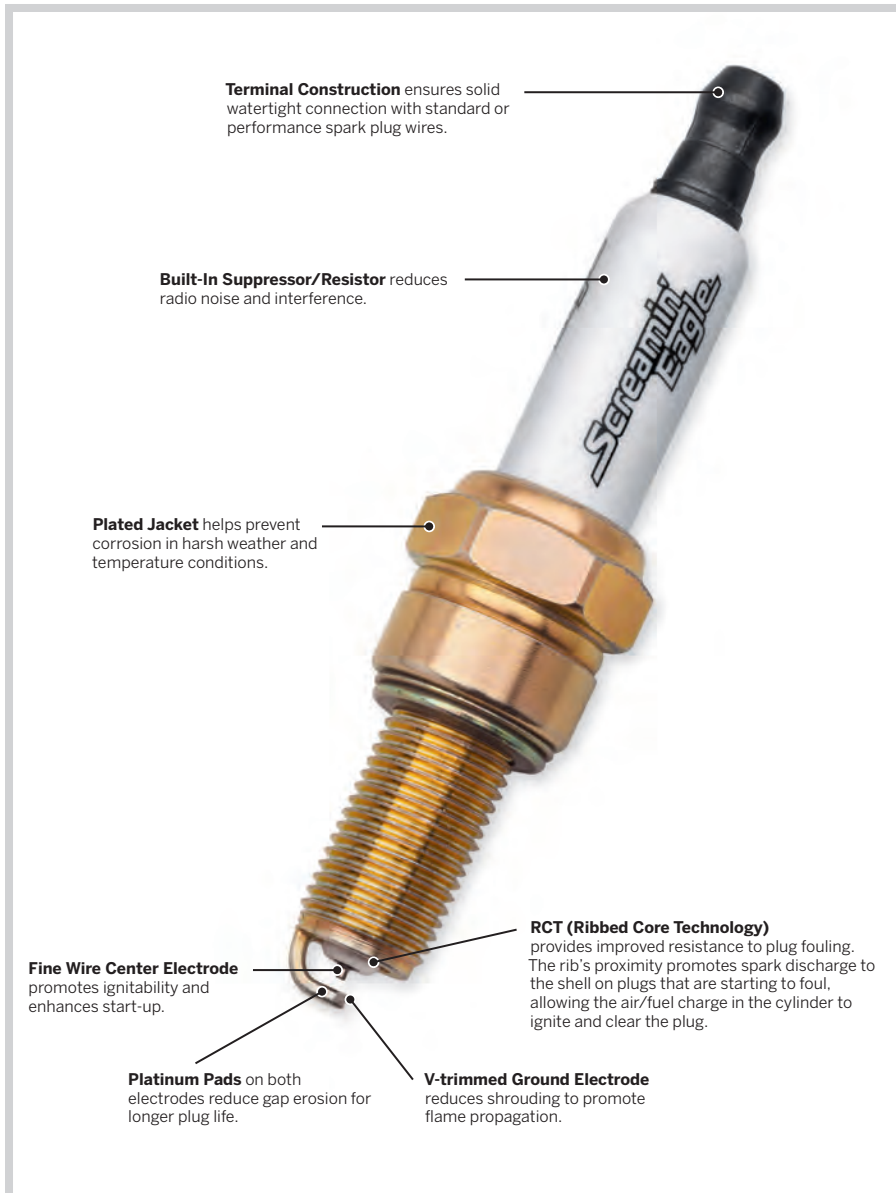

A. SCREAMIN' EAGLE PERFORMANCE SPARK PLUG



B. HARLEY-DAVIDSON GOLD SPARK PLUGS



C. HARLEY-DAVIDSON ORIGINAL EQUIPMENT SPARK PLUGS

Notice: The prices appearing in this catalog are the manufacturer's suggested retail prices. Actual retail prices may vary.

GARAGE 723

Brake Pads

D. H-D® ORIGINAL EQUIPMENT BRAKE PADS

Front		
41300169	Front.	\$49.95
Fits '16-'20 XG models (Left Side on XG750A).		
41300196	Front.	\$55.95
Fits '17-'20 XG750A models (Right Side).		
42897-08	Front.	\$54.95
Fits '08-'17 VRSC™ models.		
42897-06A	Front.	\$54.95
Fits '06-'07 VRSC models.		
41300004	Front.	\$65.95
Fits '14-later XL models.		
42831-04A	Front.	\$53.95
Fits '04-'13 XL models.		
42739-08	Front.	\$56.95
Fits '08-'13 XR models.		
46363-11	Front.	\$61.95
Fits '12-'17 Dyna® and '11-'14 Softail® (except Springer™) models.		
41300102	Front.	\$65.95
Fits '15-later Softail models.		
44082-08	Front.	\$49.95
Fits '08-'11 Dyna and '08-'10 Softail (except Springer) models.		
41854-08	Front.	\$56.95
Fits '08-later Touring and '08-'13 and '19-later Trike (includes '20-later FLHTCUTGSE) models.		
44063-83D	Front.	\$58.95
Fits '84-'99 XL, '84-'86 FX, '84-'99 FXR, '91-'99 Dyna, '00-later Springer, '84-'99 Softail and '84-'99 FLHR, FLHT and FLT models.		
41300027	Front.	\$59.95
Fits '14-'18 Trike models.		

Front & Rear		
41300072	Front/Rear.	\$44.95
Fits '15 XG models		
44082-00E	Front/Rear.	\$58.95
Fits front and rear brakes on '00-'05 VRSC, '00-'03 XL and '00-'07 Dyna, Softail and Touring models (except front brakes on FXSTS and FLSTS Springer). Does not fit '06-'07 rear brakes on FLSTFSE, FXST, FXSTB and FXSTS models.		

Rear		
41300161	Rear.	\$49.95
Fits '16-'20 XG models.		
42850-06B	Rear.	\$50.95
Fits '06-'17 VRSC models.		
41300053	Rear.	\$59.95
Fits '14-later XL models.		
42029-07	Rear.	\$46.95
Fits '07-'13 XL models.		
42836-04A	Rear.	\$46.95
Fits '04-'06 XL models.		
42310-08	Rear.	\$46.95
Fits '08-'13 XR models.		
41300197	Rear.	\$60.95
Fits '18-later Softail models.		
42298-08	Rear.	\$58.95
Fits '08-'17 Dyna and Softail models.		
44209-87D	Rear.	\$70.95
Fits later '87-'99 XL, FXR, Softail and '91-'99 Dyna models.		
41852-08B	Rear.	\$62.95
Fits '08-later Touring models. Does not fit Trike models.		
43957-86F	Rear.	\$69.95
Fits '86-'99 FLHR, FLHS, FLHT and FLT models.		
41300033	Rear.	\$101.95
Fits '14-'18 Trike models.		
83911-09B	Rear.	\$98.95
Fits '09-'13 Trike models.		
41300214	Rear.	\$137.95
Fits '19-later Trike models.		



D. H-D ORIGINAL EQUIPMENT BRAKE PADS

Notice: The prices appearing in this catalog are the manufacturer's suggested retail prices. Actual retail prices may vary.

724 GARAGE

Tire Accessories

A. MOTORCYCLE TIRE PRESSURE MONITORING SYSTEM

Proper tire pressure is critical to the operation of your motorcycle. The Harley-Davidson® Tire Pressure Monitoring System (TPMS) takes the hassle out of monitoring your vehicle's front and rear tire pressure manually. The TPMS alerts the rider to low tire pressure as soon as the vehicle is started. While riding, receive low-pressure alerts via your H-D™ Speedo/Tach or via the H-D Connect™ mobile app.

42300124A **\$213.95**
Fits '20-later Touring models (except Japan) equipped with Original Equipment or Accessory wheels that accept a TPMS sensor.

B. TIRE PRESSURE GAUGE AND FILL VALVE

Simplify checking the air pressure level and filling the tires on your motorcycle. This Tire Pressure Gauge features an 18 flexible hose and 2-way air chuck with both a 45° fill port and a unique side fill port that provides easy straight-in access to hard-to-reach motorcycle valve stems. The dual-range instant-read gauge measures pressures from 0-60 psi and 0-400 kPa, and is protected from impact and abrasion by a thick rubber collar. Designed to fit an air compressor with a standard 1/4 quick-disconnect coupler, this gauge allows you to check the pressure and fill the tire without removing the chuck from the tire. Just apply the chuck to the valve stem, read the pressure and add air by depressing the comfortable trigger lever. And for checking tire pressure on the road, you can use this tool like any standard tire gauge.

12700096A **\$84.95**

C. COMPACT AIR COMPRESSOR WITH LIGHT

Correct tire pressure is crucial to safe operation and long tire life, but checking the pressure, finding a gas station with a working air pump and filling the tire is a chore that many of us ignore. The Compact Air Compressor is designed to simplify this necessary procedure. The compact, lightweight 12V pump is designed for life on the road. The all-in-one pump plugs into your bike's battery charging harness, and features a built-in 0-160 psi pressure gauge and bright LED work light. The 11 air hose and 6' fuse-protected power cord easily reach the front and rear wheels, and are stored in convenient compartments when not in use. The lightweight pump features durable, impact-resistant construction, and is small enough to fit easily in a saddlebag or strap-on luggage. Kit includes pump, valve stem extension and nylon carrying bag.

12700020 **\$47.95**



A. MOTORCYCLE TIRE PRESSURE MONITORING SYSTEM



B. TIRE PRESSURE GAUGE AND FILL VALVE



C. COMPACT AIR COMPRESSOR WITH LIGHT



D. VALVE STEM EXTENSION



E. COMPACT TIRE GAUGE AND TREAD DEPTH INDICATOR



E. COMPACT TIRE GAUGE AND TREAD DEPTH INDICATOR WITH STAINLESS STEEL LEAD



F. DIGITAL TIRE PRESSURE GAUGE



G. TIRE GAUGE AND TREAD DEPTH INDICATOR WITH EMBOSSED LEATHER POUCH

GARAGE 725

Tire Accessories

D. VALVE STEM EXTENSION

Sometimes there's just not enough space around the tire's valve stem for the gas station air chuck and hose to reach. Brake rotors, sprockets and saddlebags get in the way and keep the air chuck from making an airtight seal. When that happens, this Valve Stem Extension provides easy access. Simply screw the extension in place on the stem, fill the tire to the proper pressure, remove the extension and replace the valve stem cap. Then toss the extension in your saddlebag or tool roll for the next time.

42300009 **\$12.95**

E. COMPACT TIRE GAUGE AND TREAD DEPTH INDICATOR

Combination dial air pressure and tread depth gauge provides easy access to the valve stem. A durable internal diaphragm provides accurate air pressure readings with a dual range indicator for 0-60 psi and 0-400 kPa readings. The pressure relief valve is activated by a push button to eliminate inner gauge air pressure after use. The integrated tire tread depth gauge features a dual-range color-coded indicator, calibrated in 1/32 (0-14/32) and millimeters (0-11mm), for monitoring tread wear. A protective rubber boot covers the housing to protect the gauge from impact and abrasion.

75008-02A Compact. **\$38.95**

75137-98B **\$45.95**

Compact with braided stainless steel lead.

F. DIGITAL TIRE PRESSURE GAUGE

Back-lit Digital Tire Pressure Gauge is easy to read at any time of day. Providing accurate pressure readings in 0.50 psi increments up to 60 psi. Scale can be changed to read psi, bar, Kg or kPa pressure with the touch of a button. This versatile gauge features a 12 braided line and 90 degree angle chuck for easy access to valve stems, and a tough rubber jacket to protect the gauge from damage. Batteries are included.

75158-10 **\$45.95**

G. TIRE GAUGE AND TREAD DEPTH INDICATOR WITH EMBOSSED LEATHER POUCH

Chrome-plated steel gauge housing with Harley-Davidson script and 90 degree air chuck. Dual range indicator for air pressure and tire tread depth readings. Calibrated for 10-50 psi and 0-32/32 tread depth readings. Rotate the indicator shaft 90 degrees in the housing for 70-345 kPa and 0-30mm tread depth readings. Complete with a Bar & Shield logo embossed leather pouch.

75110-98B **\$23.95**

DUNLOP® HARLEY-DAVIDSON®

Since 1984, Dunlop® Tires has provided Original Equipment and service replacement tires for Harley-Davidson® motorcycles. Dunlop is recognized as the world-leader in motorcycle tire design, engineering and manufacturing excellence.

DUNLOP HARLEY-DAVIDSON TIRE SERIES

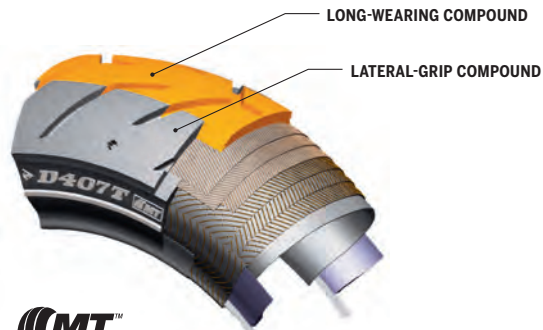

MT MULTI-TREAD
Dunlop D407T and D401T tires feature MT Multi-Tread™ technology that pairs a long-wearing center compound with a high-grip side compound for improved ride, handling and tread life.

Refer to H-D.com/shop for tire fitments or see your Dealer.

DUNLOP HARLEY-DAVIDSON D408F TOURING TIRE



DUNLOP® HARLEY-DAVIDSON® TIRES

D407/D407T/D408 TOURING

The D407/D408 tire is constructed for '09-later FL Touring, select Softail® and specific Custom Vehicle Operations™ (CVO™) models and is available exclusively through Harley-Davidson® Dealers. The FL Touring rear tires feature Dunlop's advanced MT Multi-Tread™ technology.

- Tire features bold Harley-Davidson script on the sidewall.
- MT Multi-Tread rear tire incorporates a tough tread compound in the center that runs cooler to provide stability, excellent traction under braking and long life and to each side is a section of lateral-grip compound that enhances traction at higher lean angles for great grip while cornering.
- Reinforced multi-layer tire carcass gives the tire strength for long life and provides stability at highway speeds and maximum lean angles.
- Bold, angled lateral grooves in the tread pattern evacuate water from the contact patch on wet roads.
- The D407/D408 is available in blackwall, slim white and wide white sidewall styles.
- The D407T is only available in blackwall style.



Blackwall

Slim Whitewall



Blackwall

Slim Whitewall

Wide Whitewall

Engraved Wide Whitewall

D402 TOURING

Built with a three-ply polyester casing with two fiberglass belts, the D402 offers greater load-carrying capacity and stability.

- Computer-optimized tread profile with offset center groove improves rider confidence over rain grooves and steel-grated bridges, while reducing cupping for even wear.
- The D402 is available in blackwall, slim whitewall, wide whitewall and engraved wide whitewall styles.



Blackwall

Wide Whitewall

Blackwall

Blackwall

D401/D401T CRUISER

An advanced tread pattern and specifically formulated compound deliver outstanding grip in wet or dry weather and provide long tire life.

- D401 tires use bias or bias-belted construction and incorporate a computer-optimized tread profile to reduce cupping for even wear.

GT502 PERFORMANCE

GT502 Performance Tires feature an optimized profile, contact patch and compound for superior grip in dry conditions, with solid grip during wet weather riding conditions.

SIGNATURE SERIES

Signature Series Tires are packed with features for responsive handling and confident cornering to tighten the connection between you and the road.

MICHELIN® TIRES

Since 1889, Michelin® has been a leader in the tire industry. From introducing the world's first radial tire in 1946, to being the first to use radial motorcycle tires in race competition, Michelin has demonstrated its dedication to producing some of the world's most innovative tire products. A leader in racing technology, Michelin researches, tests and develops tire solutions in the most demanding form of racing competition. Harley-Davidson® motorcycle riders benefit from that technology, as Michelin transfers track technology into Harley-Davidson motorcycle riding confidence and performance.



MICHELIN SCORCHER® 31 BLACKWALL

Refer to H-D.com/shop for tire fitments or see your Dealer.



MICHELIN® · HARLEY-DAVIDSON® TIRES

MICHELIN® SCORCHER® TIRES

Made exclusively for Harley-Davidson

The Scorchers is the first Michelin®-Harley-Davidson® co-branded tire, with a bold Harley-Davidson script on the sidewall. Featuring an exceptional combination of durability, comfort and handling. The Scorchers 11 and Scorchers 31 are factory-installed on many models, and can be installed as a replacement tire on other specified models.

- **Rear Tire Architecture:**
Provides stability, great handling, plus comfort.
- **3 Polyester Carcass Plies:**
Strong and supple casing for comfort on long rides.
- **2 Aramid Belt Plies:**
Maintains consistent contact patch for a long and even wear life.

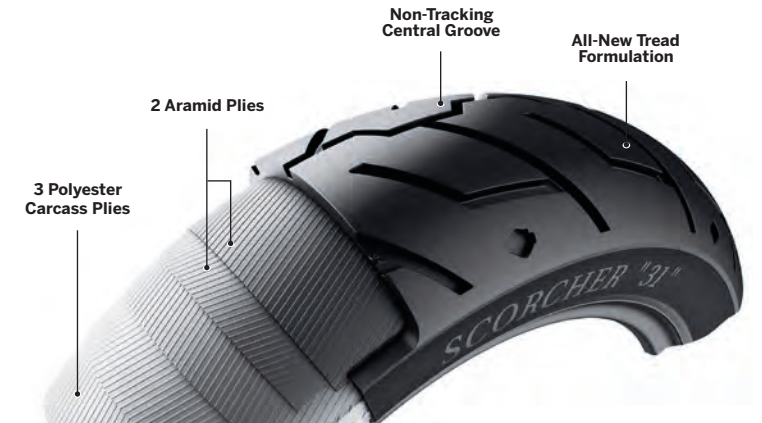

MICHELIN Scorchers 31

- **Remarkable Grip:**
Innovative rubber compounds, incorporating know-how derived from Michelin's decades of road-racing experience, provide remarkable grip on both wet and dry roads.
- **Exceptional Comfort and Handling:**
The supple casing design and profile of MICHELIN® Scorchers® 31 tires promote rock-solid handling on winding roads.
- **Long Mileage:**
Michelin carbon black-enriched rubber compounds promote excellent durability without compromising performance.

MICHELIN Scorchers 11

- **Outstanding Grip:**
Semi-slick tread pattern maximizes the contact patch for excellent adhesion on dry roads. Optimized tread groove design efficiently evacuates water for dependable wet grip.
- **Excellent Tread Life:**
Derived from Michelin's championship-winning racing tires, newly developed rubber compounds combine durability and high performance.
- **Precise Handling:**
The latest generation of Michelin radial technology allows for easy maneuverability and impressive agility.



MODEL FITMENT	STOCK OR OPTIONAL FITMENT	TREAD	SIZE	RIM SIZE IN INCHES	SIDEWALL STYLE	PART NUMBER	PRICE
---------------	---------------------------	-------	------	--------------------	----------------	-------------	-------

SPORTSTER® - FRONT

DUNLOP® HARLEY-DAVIDSON® PERFORMANCE TIRES

'96-'03 XL1200 Sport	Stock						
'04-'22 XL (except XL Custom, XL1200X, XL1200CX, XL1200V, XR1200/X, XL1200T, XL1200XS, or '11-'22 XL883L)	Optional	GT502F	100/90-19	2.15 x 19	BW	40554-04A	\$179.95
Requires installation of matching GT502 Rear Tire P/N 40555-04A							
'16-'22 XL1200CX	Stock	GT502F	120/70R19	3.00 x 19	BW	43100026	\$224.95
'99-'09 XL883C	Optional	GT502F	80/90-21	2.15 x 21	BW	43117-09	\$179.95
'96-'10 XL1200C	Optional						

DUNLOP HARLEY-DAVIDSON TIRE SERIES

'10-'22 XL1200X	Stock '10	D402F	MT90B16	3.00 x 16	BW	43022-91A	\$204.95
'04-'22 XL (except XL Custom, XL1200X, XL1200CX, XL1200V, XR1200/X, XL1200T, XL1200XS, XL1200NS or '11-'22 XL883L)	(BW) Stock '04-'10	D401F	100/90-19	2.15 x 19	WWW	55193-10	\$218.95
'91-'09 XL883, XL883R, XL883 Hugger™ (except XL Custom)					BW	43100063	\$179.95
'88-'03 XL1200 (except XL Custom, XL Sport)	Stock	D401F	100/90-19	2.15 x 19	BW	43100063	\$179.95
'83-'84 XR1000							
'96-'10 XL883C, XL1200C							
'12-'16 XL1200V							
		D402F	MH90-21	2.15 x 21	BW	43104-93A	\$174.95
		D402F	MH90-21	2.15 x 21	MWW	43100004	\$204.95

MICHELIN® HARLEY-DAVIDSON TIRE SERIES

'11-'22 XL1200C	Stock '11-later	SCORCHER 31	130/90B16	3.00 x 16	BW	55035-11A	\$299.95
'18-'22 XL1200XS							
'10-'22 XL1200X	Stock	SCORCHER 11F	120/70ZR18	3.50 x 18	BW	40879-11A	\$299.95
'11-'22 XL883L							
'08-'13 XR1200/X	Stock '12-'13						
'14-'22 XL1200T	Stock	SCORCHER 11T	120/70ZR18	3.50 x 18	BW	43100021A	\$309.95
'04-'22 XL (except XL Custom, XL1200XS, XL1200X, XL1200CX, XL1200V, XR1200/X, XL1200T or '11-'22 XL883L)	Stock '11-later	SCORCHER 31	100/90B19	2.15 x 19	BW	43258-07B	\$249.95
'12-'16 XL1200V	Optional	SCORCHER 31	80/90-21	2.15 x 21	BW	41036-12	\$209.95
'04-'10 XL 883C							
'04-'10 XL 1200C							

SPORTSTER® - REAR

DUNLOP HARLEY-DAVIDSON PERFORMANCE TIRES

'04-'22 XL (except XL1200XS, XL1200NS XL1200X, XL1200CX, XL1200V, XR1200/X, XL1200T '11-'22 XL883L or '11-'22 XL1200C). Installation on models with 19 front wheel requires installation of matching GT502F Front Tire P/N 40554-04A	Optional	GT502	150/80B16	3.00 x 16	BW	40555-04A	\$259.95
'96-'03 XL1200 Sport	Stock	GT502	130/90B16	3.00 x 16	BW	40556-06A	\$259.95
'16-'22 XL1200CX	Stock	GT502	150/70R18	4.25 x 18	BW	43200030	\$294.95

DUNLOP HARLEY-DAVIDSON TIRE SERIES

'04-'22 XL (except XL1200XS, XL1200NS, XL1200CX, XR1200/X, XL1200V, XL1200T, '11-'22 XL883L or '11-'22 XL1200C)	Stock '04-'10	D401	150/80B16	3.00 x 16	BW	43200063	\$248.95
'04-'22 XL (except XL1200XS, XL1200NS, XL1200CX, XL1200X, XL1200V, XR1200/X, XL1200T, '11-'22 XL883L or '11-'22 XL1200C)	Optional	D401	150/80B16	3.00 x 16	WWW	55192-10	\$294.95
'12-'16 XL1200V	Stock	D401	150/80B16	3.00 x 16	MWW	43200007	\$274.95
'81-'03 XL (except XL1200 Sport)	Stock	D401	130/90B16	3.00 x 16	BW	40565-91B	\$209.95
'08-'13 XR1200/X	Stock '08-'11	D209HD	180/55ZR17	5.50 x 17	BW	43231-08	\$324.95

Sidewall Style Key:
BW – Blackwall
SWW – Slim Whitewall

MWW – Medium Whitewall
WWW – Wide Whitewall
EWVV – Engraved Wide Whitewall



WARNING: Use only Harley-Davidson approved tires. Using non-approved tires or mixing approved tires from different manufacturers on the same motorcycle, can adversely affect stability, which could result in death or serious injury.

MODEL FITMENT	STOCK OR OPTIONAL FITMENT	TREAD	SIZE	RIM SIZE IN INCHES	SIDEWALL STYLE	PART NUMBER	PRICE
---------------	---------------------------	-------	------	--------------------	----------------	-------------	-------

SPORTSTER® - REAR CONTINUED

MICHELIN® HARLEY-DAVIDSON® TIRE SERIES

'04-'22 XL (except XL1200CX, XR1200/X, XL1200T or '11-'22 XL883L)	Stock '11-later (except XL1200V)	SCORCHER 31	150/80B16	3.00 x 16	BW	40878-11	\$309.95
'11-'22 XL883L	Stock	SCORCHER 11	150/60ZR17	4.50 x 17	BW	43216-11	\$289.95
'14-'22 XL1200T	Stock	Scorcher 11T	150/70ZR17	4.50 x 17	BW	43200026A	\$299.95
'08-'13 XR1200/X	Stock '12-'13	SCORCHER 11	180/55ZR17	5.50 x 17	BW	43200011	\$424.95

DYNA® – FRONT

DUNLOP® HARLEY-DAVIDSON PERFORMANCE TIRES

02-'17 Dyna® (except FLD, FXDF, FXDFSE, FXDSE and FXDWG models)	Optional	GT502F	100/90-19	2.15 x 19	BW	40554-04A	\$179.95
'00-'01 FXDX	Stock						
'93-'17 FXDWG	Stock '10-'11	GT502F	80/90-21	2.15 x 21	BW	43117-09	\$179.95

DUNLOP HARLEY-DAVIDSON TIRE SERIES

'08-'17 FXDF	Stock	D427F	130/90B16	3.00 x 16	BW	43218-08	\$229.95
'09-'10 FXDFSE							
'12-'16 FLD	Stock	D402F	130/70B18	3.50 x 18	BW	43371-07A	\$249.95
'91-'17 Dyna models (except FLD, FXDF, FXDFSE, FXDSE and FXDWG models)	Stock '91-'09	D401F	100/90-19	2.15 x 19	BW	43100063	\$179.95
'84-'94 FXR (except FXLR, FXR2)							
'83-'92 FXRT	Stock						
'06-'17 Dyna models (except FLD, FXDF, FXDFSE, FXDSE and '10-'17 FXDWG)	Optional	D401F	100/90-19	2.15 x 19	WWW	55193-10	\$218.95
'06-'08 FXDWG	Optional	D402F	MH90-21	2.15 x 21	MWW	43100004	\$204.95
'93-'08 FXDWG	Stock	D402F	MH90-21	2.15 x 21	BW	43104-93A	\$174.95
'81-'86 FXWG							
'87-'94 FXLR							
'99 FXR2							
'07-'08 FXDSE							

MICHELIN HARLEY-DAVIDSON TIRE SERIES

'02-'17 Dyna (except FLD, FXDF, FXDFSE, FXDSE and FXDWG models)	Stock '10-'17	SCORCHER 31	100/90B19	2.15 x 19	BW	43258-07B	\$249.95
'10-'17 FXDWG	Stock '12-'17	SCORCHER 31	80/90-21	2.15 x 21	BW	41036-12	\$209.95

DYNA – REAR

DUNLOP HARLEY-DAVIDSON PERFORMANCE TIRES

'00-'01 FXDX	Stock						
'02-'05 Dyna	Optional	GT502	150/80B16	3.00 x 16	BW	40555-04A	\$259.95
'10-'17 FXDWG	Stock '10-'11	GT502	180/60B17	4.50 x 17	BW	43197-04B	\$354.95
Replacement Tire for Harley-Davidson® Wide Tire Kits P/N 44075-04, 43705-06, 43768-06	Optional						

DUNLOP HARLEY-DAVIDSON TIRE SERIES

'82-'00 FXR	Stock	D401	130/90B16	3.00 x 16	BW	40565-91B	\$209.95
'82-'92 FXRT							
'91-'01 Dyna (except '00-'01 FXDX)							
'02-'05 Dyna							
'08-'17 FXDF							
'09-'10 FXDFSE	D427	180/70B16	5.00 x 16	BW	43228-08	\$344.95	
'07-'08 FXDSE	D407	170/60R17	4.50 x 17	BW	41998-07	\$299.95	
06-'17 Dyna (except FLD, FXDF, FXDFSE, FXDSE and '10-later FXDWG)	Stock '06-'09	K591	160/70B17	4.50 x 17	BW	43169-00A	\$289.95
'12-'16 FLD	Stock	D401	160/70B17	4.50 x 17	BW	43200015	\$322.95

MICHELIN HARLEY-DAVIDSON TIRE SERIES

'06-'17 Dyna (except FLD, FXDF, FXDFSE, FXDSE and '10-'17 FXDWG)	Stock '10-'17	SCORCHER 31	160/70B17	4.50 x 17	BW	43250-07B	\$359.95
'10-'17 FXDWG	Stock '12-'17	SCORCHER 31	180/60B17	4.50 x 17	BW	43200005	\$369.95

MODEL FITMENT	STOCK OR OPTIONAL FITMENT	TREAD	SIZE	RIM SIZE IN INCHES	SIDEWALL STYLE	PART NUMBER	PRICE
SOFTAIL® – FRONT							
DUNLOP® HARLEY-DAVIDSON® PERFORMANCE TIRES							
'84-'07 FXST	Optional	GT502F	80/90-21	2.15 x 21	BW	43117-09	\$179.95
'99-'07 FXSTB							
'86-'07 FXSTC							
'00-'07 FXSTD							
'88-'06 FXSTS							
DUNLOP HARLEY-DAVIDSON TIRE SERIES							
'18-later FLDE	WWW Stock	D402F D401F	MT90B16 130/90B16	3.00 x 16	WWW BW	43118-92A 43100029	\$249.95 \$209.95
'18-later FLHC/S	BW Stock						
'18-later FLSL	BW Stock	D401F	110/90-19	2.50 x 19	BW	43100063	\$179.95
'18-'20 FXBB							
'21-later FXBBS							
'20-later FXST							
'18-later FXFB/S	Stock						
'18-later FXBR/S	Optional	D408F	130/60B21	3.50 x 21	BW	43100008	\$209.95
'18-later FLSC	Optional						
'18-later FLSC	Optional	D408F	130/70B18	3.50 x 18	BW	44026-09A	\$249.95
'19-later FXDRS	Optional						
'19-later FXDRS	Optional	GT502F	120/70R19	3.00 x 19	BW	43100026	\$224.95
'86-'10 FLST	BW Stock						
'87-'17 FLSTC	BW Stock '87-'17 WWW Stock '09-'17	D402F	MT90B16	3.00 x 16	WWW SWW BW	43118-92A 43115-91A 43022-91A	\$249.95 \$239.95 \$204.95
'90-'06 FLSTF	BW Stock						
'93-'17 FLSTN	WWW Stock						
'97-'03 FLSTS	WWW Stock						
'05-'07 FLSTSC	BW Stock						
'08-'11 FLSTSB	BW Stock	D402F	MT90B16	3.00 x 16	WWW	43118-92A	\$249.95
'14-'15 FLSTNSE	Stock						
'05 FLSTFSE	Stock	D402F	MT90B16	3.00 x 16	BW	43022-91A	\$204.95
'12-'17 FLS							
'16-'17 FLSS							
'07-'17 FLSTF	Stock	D408F	140/75R17	3.50 x 17	BW	41474-06B	\$259.95
'10-'16 FLSTFB							
'16-'17 FLSTFBS							
'06 FLSTFSE	Stock	D408F	130/70R18	3.50 x 18	BW	41999-07B	\$299.95
'10-'12 FLSTSE							
'08-'09 FXSTSSE	Stock	D408F	90/90-19	2.15 x 19	BW	41566-08B	\$174.95
'08-'09 FXCW							
'08-'11 FXCWC	Stock	D408F	130/60B19	3.50 x 19	BW	43100045	\$261.95
'16-'17 FXSE							
'84-'07 FXST	Stock	D402F	MH90-21	2.15 x 21	BW	43104-93A	\$174.95
'99-'07 FXSTB							
'86-'07 FXSTC							
'00-'07 FXSTD							
'03-'04 FXSTDSE							
'88-'06 FXSTS							
'07 FXSTSSE							
'11-'13 FXS							
'08-'15 FXST							
'08-'09 FXSTB							
'08-'10 FXSTC							
'13-'17 FXSB, FXSBSE	Stock	D408F	130/60B21	3.50 x 21	BW	43100008	\$209.95

Sidewall Style Key:
BW – Blackwall
SWW – Slim Whitewall

MWW – Medium Whitewall
WWW – Wide Whitewall
EWVW – Engraved Wide Whitewall



WARNING: Use only Harley-Davidson approved tires. Using non-approved tires or mixing approved tires from different manufacturers on the same motorcycle, can adversely affect stability, which could result in death or serious injury.

MODEL FITMENT	STOCK OR OPTIONAL FITMENT	TREAD	SIZE	RIM SIZE IN INCHES	SIDEWALL STYLE	PART NUMBER	PRICE	
SOFTAIL® – FRONT CONTINUED								
MICHELIN® HARLEY-DAVIDSON® TIRE SERIES								
'18-later FLFB/S	Stock	SCORCHER 11	160/60R18	4.50 x 18	BW	43100037	\$349.95	
'18-later FXBR/S	Stock	SCORCHER 11	130/60B21	3.50 x 21	BW	43100035	\$299.95	
'18-later FXLR	Stock	SCORCHER 31	110/90B19	2.50 x 19	BW	43100038B	\$324.33	
'20-later FXLRS								
'22 FXRST								
'22-later FXLRST	Optional	SCORCHER 31	130/90B16	3.00 x 16	BW	55035-11A	\$299.95	
'18-later FLDE								
'18-later FLHC/S								
'18-later FLSL	Optional	SCORCHER 31	100/90B19	2.15 x 19	BW	43258-07B	\$249.95	
'18-'20 FXBB								
'21-later FXBBS	Stock	SCORCHER 31	130/70B18	3.50 x 18	BW	43100015A	\$309.95	
'18-later FXLSB	Stock	SCORCHER 11	120/70ZR19	3.00 x 19	BW	43213-11	\$309.95	
'19-later FXDRS	Optional	SCORCHER 11	140/75R17	3.50 x 17	BW	43100016	\$319.95	
'07-'17 FLSTF								
'10-'16 FLSTFB								
'16-'17 FLSTFBS								
SOFTAIL® – REAR								
DUNLOP® HARLEY-DAVIDSON PERFORMANCE TIRES								
'03-'05 Softail® (except FXSTD, FLSTS)	Optional	GT502	150/80B16	3.00 x 16	BW	40555-04A	\$259.95	
Replacement tire for Harley-Davidson Wide Tire Kits P/N 43684-99A, 43685-00A, 44490-00A								
'04 FXSTDSE	Stock	GT502	180/60B17	4.50 x 17	BW	43197-04B	\$354.95	
DUNLOP HARLEY-DAVIDSON TIRE SERIES								
'18-later FLDE	WWW Stock	D402 D401T	MU85B16 150/80B16	3.00 x 16	WWW BW	43353-03 43200063	\$299.95 \$248.95	
'18-later FLHC/S	BW Stock							
'18-later FLSL	BW Stock	D401T	150/80B16	3.00 x 16	BW	43200063	\$248.95	
'20-later FXBBS								
'18-'20 FXBB								
'20-later FXST								
'18-later FXFB/S	Stock							
'18-later FXBR/S	Optional	D407	240/40R18	8.00 x 18	BW	41688-08A	\$359.95	
'18-later FLSC	Optional							
'19-later FXDRS	Optional	D407	240/40R18	8.00 x 18	BW	41688-08A	\$359.95	
'87-'02 FLSTC	BW Stock							
'90-'02 FLSTF	BW Stock	D402	MT90B16	3.00 x 16	WWW SWW BW	43119-92A 43114-91B 43102-91B	\$289.95 \$279.95 \$244.95	
'97-'02 FLSTS	WWW Stock							
'93-'96 FLSTN	WWW Stock							
'86-'90 FLST	BW Stock							
'99-'02 FXST	BW Stock							
'95-'97 FXSTSB	BW Stock							
'95-'99 FXSTC	BW Stock							
'95-'02 FXSTS	BW Stock							
'99-'02 FXSTB	Stock							
'14-'15 FLSTNSE	Stock							
'05-'17 FLSTN	WWW Stock	D402	MU85B16	3.00 x 16	WWW SWW BW	43353-03 43332-04 43200001	\$299.95 \$284.95 \$249.95	
'03 FLSTS	WWW Stock							
'11-'13 FXS	BW Stock							

Sidewall Style Key:
BW – Blackwall
SWW – Slim Whitewall

MWW – Medium Whitewall
WWW – Wide Whitewall
EWVW – Engraved Wide Whitewall



WARNING: Use only Harley-Davidson approved tires. Using non-approved tires or mixing approved tires from different manufacturers on the same motorcycle, can adversely affect stability, which could result in death or serious injury.

MODEL FITMENT	STOCK OR OPTIONAL FITMENT	TREAD	SIZE	RIM SIZE IN INCHES	SIDEWALL STYLE	PART NUMBER	PRICE
SOFTAIL® – REAR CONTINUED							
DUNLOP® HARLEY-DAVIDSON® TIRE SERIES							
'12-'17 FLS	Stock	D402	MU85B16	3.00 x 16	BW	43200001	\$249.95
'16-'17 FLSS							
'84-'90 FXST							
'84-'94 FXSTC	Stock	D401	130/90B16	3.00 x 16	BW	40565-91B	\$209.95
'84-'94 FXSTS							
'03-'17 FLSTC	(BW) Stock (WWW) Stock '09-later (SWW) Option	D401 D402 D402	150/80B16 MU85B16 MU85B16	3.00 x 16	BW WWW SWW	43200063 43353-03 43332-04	\$248.95 \$299.95 \$284.95
'03-'05 Softail® (except FXSTD, FLSTS)							
'03-'06 FLSTF							
'05 FLSTFSE	Stock	D401	150/80B16	3.00 x 16	BW	43200063	\$248.95
'05-'07 FLSTSC							
'06-'10 FLST							
'07-'17 FLSTF							
'10-'16 FLSTFB							
'16-'17 FLSTFBS							
'06 FLSTFSE							
'06-'15 FXST	Stock	D407	200/55R17	6.00 x 17	BW	43242-06B	\$299.95
'06-'09 FXSTB							
'06-'10 FXSTC							
'06 FXSTS							
'07-'08 FXSTSSE							
08-'11 FLSTSB	Stock	D401	200/55R17	6.00 x 17	BW	43970-08	\$279.95
'00-'07 FXSTD (except '04 FXSTDSE)	Stock	K591	160/70B17	4.50 x 17	BW	43169-00A	\$289.95
'03 FXSTDSE							
'16-'17 FXSE							
'08-'09 FXCW							
'08-'11 FXCWC	Stock	D407	240/40R18	8.00 x 18	BW	41688-08A	\$359.95
'13-'17 FXSB, FXSBSE							
'09 FXSTSSE							
MICHELIN® HARLEY-DAVIDSON TIRE SERIES							
'18-later FLFB/S	Stock	SCORCHER 11	240/40R18	8.00 x 18	BW	43189-11	\$399.95
'18-later FXBR/S							
'19-later FXDRS							
'18-later FXLR and FLSE							
'20-later FXLRS	Stock	SCORCHER 31	180/70B16	5.00 x 16	BW	43200038A	\$399.95
'22 FXRST							
'22-later FXLRST							
'18-later FLDE							
'18-later FLHC/S							
'18-later FLSL	Optional	SCORCHER 31	150/80B16	3.00 x 16	BW	40878-11	\$309.95
'20-later FXST							
'21-later FXBBS							
'18-'20 FXBB							
'07-'17 FLSTF							
'10-'16 FLSTFB	Optional	SCORCHER 11	200/55R17	6.00 x 17	BW	43200022	\$349.95
'16-'17 FLSTFBS							

MODEL FITMENT	STOCK OR OPTIONAL FITMENT	TREAD	SIZE	RIM SIZE IN INCHES	SIDEWALL STYLE	PART NUMBER	PRICE
TOURING – FRONT							
DUNLOP® HARLEY-DAVIDSON® TIRE SERIES							
'18-later FLTRXSE	Stock	D408F	130/60B21	3.50 x 21	BW	43100008	\$209.95
'21 FLH	Stock	D402F	MT90B16	3.00 x 16	WWW	43118-92A	\$249.95
14-'19 FLHRC							
'05 FLHTCSE2	Stock	D402F	MT90B16	3.00 x 16	BW	43022-91A	\$204.95
'06-'08 FLHTCUSE	Stock						
'09-'13 FLHRC and FLHRC/TLE Sidecar	Stock	D408F	130/90B16	3.00 x 16	WWW	43211-09A	\$269.95
'04-'08 TLE/Ultra Sidecar	Optional						
'98-'08 FLTR	SWW '98-'02, BW '03-'08						
'98-'08 FLHRC	WWW Stock						
'94-'08 FLHR (except '07-'08 FLHRSE)	SWW Stock						
'84-'08 FLHX	BW Stock	D402F	MT90B16	3.00 x 16	WWW	43118-92A	\$249.95
'84-'93 FLHS	Optional				SWW	43115-91A	\$239.95
'83-'08 FLHTC/U	SWW Stock				BW	43022-91A	\$204.95
'83-'08 FLHT	SWW '83-'02, BW '03-'08						
'81-'96 FLT, FLTC, FLTCU	SWW Stock						
'81-'84 FLH, FLH C	Optional						
'16-later FLTRU	Stock						
'15-'16 FLTRUSE	Stock						
'14-'19 FLHR	Stock						
'14-'19 FLHTCU	Stock	D408F	130/80B17	3.00 x 17	BW	43109-09A	\$259.95
'14-'19 FLHTK/FLHTKSE	Stock						
'19-later FLHT	Stock						
'14-later FLHP	Stock						
'14-later FLHTP	Stock						
'09-'13 FLHP/E FLHTP	Stock	D408F	130/80B17	3.00 x 17	BW	43109-09A	\$259.95
'09-'13 FLHR	SWW Stock						
'09-'10 FLHT	BW Stock						
'09-'13 FLHTC/U	SWW Stock						
'09-'13 FLHTCUSE	BW Stock	D408F	130/80B17	3.00 x 17	BW	43109-09A	\$259.95
'10-'13 FLHTK	SWW Stock				SWW	43115-09A	\$269.95
'09 FLHX, FLTR	BW Stock						
'11-'13 FLTRU	BW Stock						
'09-'13 TLE Sidecar (except FLHRC/TLE)	Optional						
'04-'08 FL Touring models equipped with 18 accessory Front Wheel (except '07-'08 FLHRSE)	Optional	D402F	130/70-18	3.50 x 18	BW	43371-07A	\$249.95
'19 FLHTKSE	Stock	D408F	130/60B19	3.50 x 19	BW	43100045	\$261.95
'07-'08 FLHRSE	Optional	D408F	130/70R18	3.50 x 18	BW	41999-07B	\$299.95
'10-'13 FLHX and FLTRX	Stock						
'10 FLHXSE	Stock						
'09 FLTRSE	Stock	D408F	130/70B18	3.50 x 18	BW	44026-09A	\$249.95
'11 FLTRUSE	Stock						
'09-later Touring models equipped with 18 accessory wheels	Optional						
'20-later FLHR, FLHTK and FLTRK	Stock						
'17-later FLHRXS	Stock						
'15-later FLTRX, FLTRXS	Stock						
'14-later FLHX, FLHXS	Stock						
'13-'14 FLHRSE	Stock						
'12-'13 and FLTRXSE	Stock	D408F	130/60B19	3.50 x 19	BW	43100045	\$261.95
'11-later FLHXSE	Stock						
'20-later FLHTKSE	Stock						
22 FLTRKSE, FLHXST, FLTRXST	Stock						
'09-later Touring models equipped with 19 accessory wheels	Optional						

Sidewall Style Key:
BW – Blackwall
SWW – Slim Whitewall

MWW – Medium Whitewall
WWW – Wide Whitewall
EWWW – Engraved Wide Whitewall



WARNING: Use only Harley-Davidson approved tires. Using non-approved tires or mixing approved tires from different manufacturers on the same motorcycle, can adversely affect stability, which could result in death or serious injury.

MODEL FITMENT	STOCK OR OPTIONAL FITMENT	TREAD	SIZE	RIM SIZE IN INCHES	SIDEWALL STYLE	PART NUMBER	
TOURING – FRONT CONTINUED							
MICHELIN® HARLEY-DAVIDSON® TIRE SERIES							
'09-'19 FLHR, FLHTCU, FLHTCUTC, FLHTCUL, FLHTCULTC, FLTRU, FLHTK, FLHTKL, FLHTKSE	Optional	SCORCHER 31	130/80B17	3.00 x 17	BW	43100014	\$319.95
'09-'13 FLHT, FLHTC, FLTR, FLHTCUSE							
'09 FLHX							
'20-later FLHT	Optional	SCORCHER 31	130/70B18	3.50 x 18	BW	43100015A	\$309.95
'09-later FLHP/E, FLHTP							
'10-'13 FLHX and FLTRX							
09-later Touring models equipped with 18 accessory wheels and 16 Rear Michelin	Optional	SCORCHER 31	130/60B19	3.50 x 19	BW	43100023	\$239.95
'15-'19 FLTRX							
'15-'17 FLTRXS							
'14-'19 FLHX							
'14-'17 FLHXS							
'09-later Touring models equipped with 19 accessory wheels and 16 Rear Michelin							

MODEL FITMENT	STOCK OR OPTIONAL FITMENT	TREAD	SIZE	RIM SIZE IN INCHES	SIDEWALL STYLE	PART NUMBER	PRICE
TOURING – REAR							
DUNLOP® HARLEY-DAVIDSON TIRE SERIES							
'14-'19 Touring (except FLHRC, FLHRXS, FLHRSE, FLHXSE)	Stock	D407T	180/65B16	5.00 x 16	BW	43200027	\$339.95
'14-'17 FLHXS							
'20-later FLHP, FLHTP and FLHT							
'15-'17 FLTRXS	Stock	D407T	180/65B16	5.00 x 16	WWW	43200054	\$359.95
'14-'19 FLHRC							
'21 FLH							
'09-'13 FLHP/E, FLHTP	Stock	D407T	180/65B16	5.00 x 16	BW	43200027	\$339.95
'09-'13 FLHRC							
'09-'13 FLHTC							
'09-'13 FLHTCU	SWW Stock	D407T	180/65B16	5.00 x 16	BW	43200027	\$339.95
'09-'13 FLHR							
'09-'10 FLHT							
'09-'13 FLHTCUSE	SWW Stock	D407	180/65B16	5.00 x 16	SWW	43332-09	\$339.95
'10-'19 FLHTK							
'09-'13 FLHX							
'09-'13 FLTR/U	BW Stock	D402	MU85B16	3.00 x 16	BW	43200001	\$249.95
'10-'13 FLTRX							
'04-'05 FLHTCSE							
'06-'08 FLHTCUSE	Stock	D402	MU85B16	3.00 x 16	BW	43200001	\$249.95
'04-'08 FLHX							
Optional							
'04-'08 FLHR (except '07-'08 FLHRSE)	SWW Stock	D402	MU85B16	3.00 x 16	WWW	43353-03	\$299.95
'04-'08 FLHRC							
'04-'08 FLHT							
'04-'08 FLHTC	SWW Stock	D402	MU85B16	3.00 x 16	SWW	43332-04	\$284.95
'04-'08 FLHTCU							
'04-'08 FLTR							

Sidewall Style Key:
BW – Blackwall
SWW – Slim Whitewall

MWW – Medium Whitewall
WWW – Wide Whitewall
EWWW – Engraved Wide Whitewall



WARNING: Use only Harley-Davidson approved tires. Using non-approved tires or mixing approved tires from different manufacturers on the same motorcycle, can adversely affect stability, which could result in death or serious injury.

TOURING – REAR CONTINUED														
DUNLOP® HARLEY-DAVIDSON® TIRE SERIES														
'81-'84 FLH	D402	MT90B16	3.00 x 16	WWW SWW BW	43119-92A 43114-91B 43102-91B		\$289.95 \$279.95 \$244.95							
'94-'03 FLHR														
'98-'03 FLHRC														
'81-'93 FLHS														
'83-'03 FLHT														
'83-'03 FLHTC/U														
'81-'85 FLT														
'98-'03 FLTR														
'81-'03 CLE, RLE, TLE/Ultra Sidecar														
'07-'08 FLHRSE								D407	170/60R17	4.50 x 17	BW	41998-07		\$299.95
'17-later FLHRXS														
'18-later FLHXS														
'18-later FLTRXS														
'13-'14 FLHRSE														
'12-'13 and '18-later FLTRXSE														
'11 FLTRUSE	D407	180/55B18	5.00 x 18	BW	43200045		\$349.95							
'10-later FLHXSE														
'19-later FLHTKSE														
'22 FLTRKSE, FLHXST, FLTRXST														
'20-later FLHR, FLHX, FLTRX, FLHTK and FLTRK														
'09 FLTRSE														
DUNLOP HARLEY-DAVIDSON TIRE SERIES														
'09-'19 Touring (except FLHRSE, FLHXSE, FLTRSE, FLTRXSE, FLTRUSE)								Optional	SCORCHER 31	180/65B16	5.00 x 16	BW	43200021	\$399.95
'14-'17 FLHXS														
'15-'17 FLTRXS														
'20-'22 FLHT														

Sidewall Style Key:
BW – Blackwall
SWW – Slim Whitewall

MWW – Medium Whitewall
WWW – Wide Whitewall
EWWW – Engraved Wide Whitewall



WARNING: Use only Harley-Davidson approved tires. Using non-approved tires or mixing approved tires from different manufacturers on the same motorcycle, can adversely affect stability, which could result in death or serious injury.

ORIGINAL EQUIPMENT AND RECOMMENDED REPLACEMENT TIRES

MODEL FITMENT	STOCK OR OPTIONAL FITMENT	TREAD	SIZE	RIM SIZE IN INCHES	SIDEWALL STYLE	PART NUMBER	PRICE
TRIKE – FRONT							
DUNLOP® HARLEY-DAVIDSON® TIRE SERIES							
'20-later FLHTCUTGSE '23 FLTRT	Stock	D408F	130/60B19	3.50 x 19	BW	43100045	\$261.95
'21 - Later FLHTCUTG (China only)							
'20-later FLRT							
'15-'19 FLRT	Stock	D408F	130/60B19	3.50 x 19	BW	43100045	\$261.95
'09-later FLHTCUTG (except China)	(BW) Stock	D402F	MT90B16	3.00 x 16	WWW	43118-92A	\$249.95
'10-'11 FLHXXX					BW	43022-91A	\$204.95

TRIKE – REAR

MODEL FITMENT	STOCK OR OPTIONAL FITMENT	TREAD	SIZE	RIM SIZE IN INCHES	SIDEWALL STYLE	PART NUMBER	PRICE
DUNLOP HARLEY-DAVIDSON TIRE SERIES							
'20-later FLHTCUTGSE '23 FLTRT	Stock	TK100	P215/45R18	7.00x18	BW	43200046	\$237.95
'23 FLRT							
'21-later FLHTCUTG (China only)							
'15-'22 FLRT	Stock	SIGNATURE	P205/65R15	5.50 x 15	BW	83324-09B	\$179.95
'09-later FLHTCUTG							
'10-'11 FLHXXX							

LIVEWIRE® TIRE FITMENT GUIDE

ORIGINAL EQUIPMENT AND RECOMMENDED REPLACEMENT TIRES

MODEL FITMENT	STOCK OR OPTIONAL FITMENT	TREAD	SIZE	RIM SIZE IN INCHES	SIDEWALL STYLE	PART NUMBER	PRICE
LIVEWIRE - FRONT							
MICHELIN® HARLEY-DAVIDSON TIRE SERIES							
'20 ELW	Stock	SCORCHER SPORT	120/70R17	3.5x17	BW	43100041	\$249.95
'21-later LW1	Stock	SCORCHER SPORT	120/70R17	3.5x17	BW	43100041	\$249.95

LIVEWIRE - REAR

MODEL FITMENT	STOCK OR OPTIONAL FITMENT	TREAD	SIZE	RIM SIZE IN INCHES	SIDEWALL STYLE	PART NUMBER	PRICE
MICHELIN HARLEY-DAVIDSON TIRE SERIES							
'20 ELW	Stock	SCORCHER SPORT	180/55R17	5.5x17	BW	43200041	\$324.95
'21-later LW1	Stock	SCORCHER SPORT	180/55R17	5.5x17	BW	43200041	\$324.95

HARLEY-DAVIDSON STREET TIRE FITMENT GUIDE

ORIGINAL EQUIPMENT AND RECOMMENDED REPLACEMENT TIRES

MODEL FITMENT	STOCK OR OPTIONAL FITMENT	TREAD	SIZE	RIM SIZE IN INCHES	SIDEWALL STYLE	PART NUMBER	PRICE
HARLEY-DAVIDSON STREET® – FRONT							
MICHELIN HARLEY-DAVIDSON® TIRE SERIES							
'15-'20 XG (except XG750A)	Stock	SCORCHER 11	100/80-17	2.50 x 17	BW	43100017	\$237.95
'17-'20 XG750A	Stock	SCORCHER 21	120/70R17	3.50 x 17	BW	43100027	\$237.95

HARLEY-DAVIDSON STREET – REAR

MODEL FITMENT	STOCK OR OPTIONAL FITMENT	TREAD	SIZE	RIM SIZE IN INCHES	SIDEWALL STYLE	PART NUMBER	PRICE
MICHELIN HARLEY-DAVIDSON TIRE SERIES							
'15-'20 XG (except XG750A)	Stock	SCORCHER 11	140/75R15	3.50 x 15	BW	43200023	\$279.95
'17-'20 XG750A	Stock	SCORCHER 21	160/60R17	4.50 x 17	BW	43200032	\$279.95

Sidewall Style Key:
BW – Blackwall
SWW – Slim Whitewall

MWW – Medium Whitewall
WWW – Wide Whitewall
EWWW – Engraved Wide Whitewall



WARNING: Use only Harley-Davidson approved tires. Using non-approved tires or mixing approved tires from different manufacturers on the same motorcycle, can adversely affect stability, which could result in death or serious injury.

ORIGINAL EQUIPMENT AND RECOMMENDED REPLACEMENT TIRES

MODEL FITMENT	STOCK OR OPTIONAL FITMENT	TREAD	SIZE	RIM SIZE IN INCHES	SIDEWALL STYLE	PART NUMBER	PRICE	
VRSC™ – FRONT								
DUNLOP® HARLEY-DAVIDSON® TIRE SERIES								
'02- '17 VRSC™ models	Stock	'02-'10 D208F	120/70ZR19	3.00 x 19	BW	43172-01B	\$289.95	
MICHELIN® HARLEY-DAVIDSON TIRE SERIES								
'09 - '17 VRSCF	Stock	'11- '17	SCORCHER 11	120/70ZR19	3.00 x 19	BW	43213-11	\$309.95
'07- '17 VRSCDX	Stock	'11- '17						
'07-'10 VRSCAW	Optional							
'07 VRSCX	Optional							
'06 VRSCSE	Optional							

VRSC – REAR

MODEL FITMENT	STOCK OR OPTIONAL FITMENT	TREAD	SIZE	RIM SIZE IN INCHES	SIDEWALL STYLE	PART NUMBER	PRICE	
DUNLOP HARLEY-DAVIDSON TIRE SERIES								
'09- '17 VRSCF	Stock	'07-'10	D407	240/40R18	8.00 x 18	BW	41688-08A	\$359.95
'07- '17 VRSCDX	Stock	'07-'10						
'07-'10 VRSCAW	Stock							
'07 VRSCX	Stock							
'06 VRSCSE	Stock							
Replacement Tire for Harley-Davidson® Wide Tire Kit P/N 43687-06	Optional							
'02-'08 VRSC (except '06 VRSCSE, VRSCAW, VRSCDX, VRSCX and VRSCF).	Stock	D207	180/55ZR18	5.50 x 18	BW	43173-01	\$359.95	

MICHELIN HARLEY-DAVIDSON TIRE SERIES

MODEL FITMENT	STOCK OR OPTIONAL FITMENT	TREAD	SIZE	RIM SIZE IN INCHES	SIDEWALL STYLE	PART NUMBER	PRICE	
'09- '17 VRSCF	Stock	'11- '17	SCORCHER 11	240/40R18	8.00 x 18	BW	43189-11	\$399.95
'07- '17 VRSCDX	Stock	'11- '17						
'07-'10 VRSCAW	Optional							
'07 VRSCX	Optional							
'06 VRSCSE	Optional							

REVOLUTION® MAX EQUIPPED MODELS TIRE FITMENT GUIDE

ORIGINAL EQUIPMENT AND RECOMMENDED REPLACEMENT TIRES

MODEL FITMENT	STOCK OR OPTIONAL FITMENT	TREAD	SIZE	RIM SIZE IN INCHES	SIDEWALL STYLE	PART NUMBER	PRICE
REVOLUTION MAX– FRONT							
MICHELIN HARLEY-DAVIDSON TIRE SERIES							
'21-later RA1250 and RA1250S	Stock	Scocher Adventure	120/70R19	3.00 x 19	BW	43100042	\$259.95
'21-later RA1250 and RA1250S	Optional	Anahee Wild	120/70R19	3.00 x 19	BW	43100049	\$249.95
DUNLOP HARLEY-DAVIDSON TIRE SERIES							
'21-later RH1250S	Stock	GT503	160/70R17	4.5 x 17	BW	43100043	\$299.95
'22-later RH975	Stock	D401F	100/90-19	2.5 x 19	BW	43100063	\$179.95

REVOLUTION MAX– REAR

MODEL FITMENT	STOCK OR OPTIONAL FITMENT	TREAD	SIZE	RIM SIZE IN INCHES	SIDEWALL STYLE	PART NUMBER	PRICE
MICHELIN HARLEY-DAVIDSON TIRE SERIES							
'21-later RA1250 and RA1250S	Stock	Scocher Adventure	170/60R17	4.50 x 17	BW	43200042	\$319.95
'21-later RA1250 and RA1250S	Optional	Anahee Wild	170/60R17	4.50 x 17	BW	43200050	\$329.95

HARLEY-DAVIDSON X TIRE FITMENT GUIDE

MODEL FITMENT	STOCK OR OPTIONAL FITMENT	TREAD	SIZE	RIM SIZE IN INCHES	SIDEWALL STYLE	PART NUMBER	PRICE
PIRELLI HARLEY-DAVIDSON TIRE SERIES							
'23 LWZX350RA	Stock	ANGEL CT	110/70-17	3.5x17	BW	HDB140106D1780	
HARLEY-DAVIDSON X (LWZ) - FRONT							
PIRELLI HARLEY-DAVIDSON TIRE SERIES							
'23 LWZX350RA	Stock	ANGEL CT	150/60-17	4.5x17	BW	HDB140110C1780	

Sidewall Style Key:
BW – Blackwall
SWW – Slim Whitewall

MWW – Medium Whitewall
WWW – Wide Whitewall
EWWW – Engraved Wide Whitewall



WARNING: Use only Harley-Davidson approved tires. Using non-approved tires or mixing approved tires from different manufacturers on the same motorcycle, can adversely affect stability, which could result in death or serious injury.

Product	REVOLUTION MAX®	SPORTSTER®	DYNA®	SOFTAIL®	TOURING
Accessory Packages	12		–	104-105	214-215
Adaptive LED Headlamps	17	–	599	599	599
Air Cleaner Covers		343	343	343	343
Air Cleaner Kits	–	394	370	338, 370	338, 370
Air Deflectors	19	–	85	153	221, 235
Air Filter Elements	26	406, 720	406, 720	406, 720	406, 720
Antennas	–	–	–	–	585
Antifreeze and Coolant	–	–	–	–	690
Auxiliary Lighting/Fog Lamps	17	–	603	603	603, 605
Auxiliary Power Ports	–	583	583	583	583
Axle Covers	20	75	75	146	398-399
Backrest – Rider	–	64	–	155	250-251
Backrest Pads – Sissy Bar	–	66	94	126, 163	258-259
Backrest Pads – Tour-Pak®	25	–	–	–	264-265
Batteries	–	717	717	717	717
Battery Chargers	715	715	715	715	715
Battery Covers/Boxes	–	80	–	–	–
Bearing Greases	691	691	691	691	691
Belt Guards	–	77	102	184	–
Black Hardware - Engine	–	462	462	462	462
Black Standard Line Bags	–	70	654	654	654
Bluetooth® Headsets	577	577	577	577	577
Board To Peg Conversion Kit	–	–	–	137	282
Boom! Audio	–	–	–	–	562-574
Boom! Audio Amplifier Kits	–	–	–	–	564, 570
Boom! Audio SiriusXM® Satellite Radio	–	–	–	–	576
Brake Calipers	–	–	–	183	296
Brake Fluid	690	690	690	690	690
Brake Levers	27	–	–	171	282
Brake Pads	–	723	723	723	723
Brake Pedal Pads/Covers	–	–	468-497	468-497	468-497
Brake Rotors	–	642	642	642	642
Brush Guards	21	–	–	–	–
Bug Remover	694	694	694	694	694
Bungee Cords/Nets/Straps	656	656	656	656	656
Cams	–	402	–	355, 382	355, 382
Cell Phone Carriers	–	582	582	582	582
Center Stand	21	–	–	–	288
Chain Lube	–	691	691	691	691
Chizeled Handlebar	–	526	526	526	537, 540
Chopped Engine Guard	–	–	–	–	289
Chopped Tour-Pak™	–	–	–	–	672

Product	REVOLUTION MAX®	SPORTSTER®	DYNA®	SOFTAIL®	TOURING
Cleaning Brushes	698	698	698	698	698
Cleaning/Detailing Products	692	692	692	692	692
Clutch Kits	–	414	414	414	414
Coil Covers	–	–	102	145	–
Collection – #1 Skull	–	435	435	435	435
Collection – '66	426 & 470	427 & 470	428 & 470	429 & 470	430 & 470
Collection – Adversary	424 & 468, 425 & 469	425 & 468, 425 & 469	426 & 468, 425 & 469	427 & 468, 425 & 469	428 & 468, 425 & 469
Collection – Airflow	–	436 & 490-491	436 & 490-491	436 & 490-491	436 & 490-491
Collection – Black Fin	–	–	441	441	441
Collection – Dark Custom	–	434, 435	434, 435	434, 435	434, 435
Collection – Dominion™	–	–	480-482	480-482	480-482
Collection - Empire	428, 472-475	428, 472-476	428, 472-477	428, 472-478	428, 472-479
Collection - Endgame	–	–	–	478-479	478-479
Collection – H-D® Motor Co.	–	430, 431	430, 431	430, 431	430, 431
Collection – Kahuna	–	–	429, 488, 430, 489	429, 488, 430, 490	429, 488, 430, 491
Collection – Live to Ride	–	437	437	437	437
Collection – Willie G Skull	–	432-433, 484-487	432-433, 484-487	432-433, 484-487	432-433, 484-487
Collections - Wild One	427, 471	427, 471	427, 471	427, 471	427, 471
Console Kits	–	80	–	178	310
CoolFlow™ Fan Kit	–	–	–	–	236
Crate Engines	–	–	–	409	409
Cruise Control Kits	–	–	–	517	–
Daymaker™ LED Headlamps	–	601	601	601	600
Derby Covers	–	422	422	422	422
Detachable Saddlebags	23	–	96	128, 166	–
Detachable Seat Hardware	–	63	90	122	249
Detachable Sideplates/Backrest	–	64	–	123	256
Detachables Lock	–	69	–	709	709
Detailing/Cleaning Products	692	692	692	692	692
Disc Brake Locks	707	707	707	707	707
Docking Hardware - HoldFast™	–	–	–	123	–
Docking Hardware – Sissy Bar/Rack	–	–	91	123, 160	255
Dunlop Tires	739	730	731	732	735
EFI Tuners	–	332	332	332	332
Engine Guard Footpeg Mounts	–	502	502	502	502
Engine Guards	–	74	101	142, 175	288-289
Engine Mounts	–	453	–	–	449
Engines – LongBlock	–	–	418	418	418
Engines – Milwaukee-Eight®	–	–	–	410	410
Engines – Twin Cam	–	–	–	–	413
Ethanol Guard	691	691	691	691	691
Exhaust Shields	–	400	380	349	350

Product	REVOLUTION MAX®	SPORTSTER®	DYNA®	SOFTAIL®	TOURING
Fairing Edge Lights	-	-	-	-	598
Fairing Lower	-	-	-	-	234, 667
Fairing Pouches	-	-	-	-	232-233
Fairing Trim – Illuminated	-	-	-	-	598
Fender Skirts	-	-	-	188	305
Fender Strut Covers/Hardware	-	-	-	148	315
Fenders – Front	-	-	-	-	664
Flag Kits	-	658	658	658	658
Fog Lamps	17	-	603	603	603
Foot Controls	-	-	-	135-139, 170-173	280-283
Footboard Mounts	-	-	-	140	286
Footpeg Mounts/Hardware	27	502-505	502-505	502-505	502-505
Footpegs and Shifter Pegs	27	468-502	468-502	468-502	468-502
Fork Oil	-	690	690	690	690
Fork Sliders	-	-	-	176	295
Fork/Handlebar Bags	-	652	652	652	-
Forward Control Kits	36	73	98	135-139	-
Front End Kits	-	-	-	176	294
Fuel Caps – Flush Mount	27	591	591	591	591
Fuel Gauges	-	78	587	587	587
Fuel Stabilizer	691	691	691	691	691
Fuel Tank Console Doors	-	-	-	-	310-311
Funnels	689	689	689	689	689
Garage Door Opener	-	704	704	704	704
Gauge Bezels/Trim Rings	-	-	-	-	306
Gauges	-	78	587-590	587-590	587-590
Gear Indicator	-	588	588	588	588
Get-A-Grip™ Hand Grips	-	497	497	497	497
Gloss Detailer	695	695	695	695	695
Guards - Engine	-	74	101	143, 175	288-289
Guards - Hand	19	-	-	-	-
Guards - Headlamp	19	-	-	-	-
Guards - Muffler	21	-	-	-	-
Hand Control Lever Kits	-	510	510	510	510
Hand Grips	19	468-499	468-499	468-499	468-499
Handlebar Clamps	-	542	542	542	542
Handlebar Risers	19	542	542	542	542
Handlebar/Fork Bags	-	654	654	654	-
Handlebars	-	518	518	518	518
Hardware – Chrome	-	464	464	464	464
Hardware Covers	-	458	458	458	458
Harley Detailing Kit	699	699	699	699	699

Product	REVOLUTION MAX®	SPORTSTER®	DYNA®	SOFTAIL®	TOURING
Harley Hammock Touring Seats	-	-	-	117	243, 245
Harley Wash Bucket	697	697	697	697	697
H-D® Detachables	-	64	-	160	256
Headlamp Bulbs	-	600-605	600-605	600-605	600-605
Headlamp Trim Rings	-	606-610	606-610	606-610	606-610
Headlamp Visors	-	606-610	606-610	606-610	606-610
Headlamps – LED	-	600-603	600-603	600-603	600-603
Headsets	577	577	577	577	577
Heated & Cooled Seats	-	-	-	-	243
Heated Hand Grips	19	498	498	498	498
Heated Seats/Backrests	-	-	-	-	243, 264
Heavy Breather Air Cleaners	-	396	372	338, 372	338, 372
Heel Shifter	-	-	-	138, 170	283
Helmet Locks	708	708	708	708	708
Highway Peg Mounting Kits	-	72	-	502	502
Hog Ties® Straps	706	706	706	706	706
HoldFast System	-	-	-	123	-
Horns & Horn Covers	-	629-631	629-631	629-631	629-631
Inner Fairing – Color-Matched	-	-	-	-	670-671
Jiffy Stands and Extensions	21	-	100	174	280
King Size Windshields	-	-	-	111, 151	219
Knee Pads – Tank	16	91	91	122	-
Leather Rejuvenator	696	696	696	696	696
LED Headlamps	-	600-603	600-603	600-603	600-603
LED King Tour-Pak® Brake/Turn/Tail Lamp	-	-	-	-	623
LED Tail Lamps	-	613	613-617	613-618	620-625
LED Turn Signals	-	613-618	613-618	613-618	613-618
License Plate Frames & Trim	-	626-628	626-628	626-628	626-628
Lifter Covers	-	453	446	442	442
Lighted Hand Controls	-	-	-	-	516
Lithium LiFe Battery	-	717	717	717	717
Locks and Cables	707	707	707	707	707
LongBlock Program	-	-	418	418	418
Luggage - Pan America	22	-	-	-	-
Luggage – Trike	-	-	-	-	254, 278
Luggage Rack	-	68	-	127, 133, 164	270-271
Master Cylinder Cover Kits	-	511, 514	511, 514	511, 514	511, 514
Michelin Tires	739	728	728	728	728
Mid-Control Kits	36	73	-	136	-
Mid-Frame Air Deflectors/Trim	-	-	85	153	235
Milwaukee Eight® Engine Trim	-	-	-	424-443	424-443
Mini Footboard Kits	-	72, 500	500	500	500

Product	REVOLUTION MAX®	SPORTSTER®	DYNA®	SOFTAIL®	TOURING
Mirrors	-	507-509	507-509	507-509	506-509
Motorcycle Covers	702	702	702	702	702
Motorcycle Oil	682	682	682	682	682
Muffler End Caps	-	400	-	347, 348, 379	347, 348, 381
Muffler Guards	20	-	-	-	-
Mufflers	26	399	379	346-349, 379	350-352, 381
Mustache Engine Guards	-	74	101	142, 175	288
Ohlins Touring Suspension	-	-	-	-	290
Oil Change Kits	684	684	684	684	684
Oil Cooler Covers	-	-	101	144, 187	300
Oil Cooler Fan Kit	-	-	-	-	236-237
Oil Cooler Kits	-	78	103	187	237
Oil Dipsticks with Temperature Gauge	-	79	456	456	456
Oil Filters	29	688	688	688	688
Oil Pump	-	-	384	384, 367	384, 367
Oil Temperature Gauge	-	79	456	456	456
One-Piece Sissy Bar Uprights	34	65	93	125, 162	-
Onyx Premium Luggage	-	648	648	648	648
Organizer – Tour-Pak®	-	-	-	-	274-275
Paints	676	676	676	676	676
Passenger Backrest Pads	25, 126	66	94	126	258-265
Passenger Footboard Supports	-	-	-	140, 173	284
Passenger Footboards/Pans	-	-	-	141, 173	284-287
Passenger Footpeg Mounts	37	72	-	140, 173	284
Passenger Grab Rails	-	-	-	-	249
Passenger Pillions	32	61	89	120, 156	248
Phone Mounts	-	582	582	582	582
Portable Chargers	716	716	716	716	716
Power Port – 12V	-	583	583	583	583
Power Switches	-	517	517	517	517
Premium Shocks	-	-	97	-	290-293
Pushrod Covers	-	453	449	443, 449	443, 449
Pushrods	-	-	383	356, 383	356, 383
Quarter Fairing	-	59	85	106	-
Quick Wash	694	694	694	694	694
Quickshifter - Screamin' Eagle	26	-	-	-	-
Radio and Gauge Trim	-	-	-	-	306-309
Rain Covers – Seats	-	703	-	121, 158	253
Reach Seats	18	60	87	114, 154	240-241
Reach® Handlebars	-	-	520	520-521	533, 535
Rider Backrests	-	63	-	117, 155	250-251
Rider Footboards/Inserts	-	-	468-495	468-495	468-495

Product	REVOLUTION MAX®	SPORTSTER®	DYNA®	SOFTAIL®	TOURING
Riser and Clamp Kits	19	542-545	542-545	542-545	542-545
Road Glide® Windshields	-	-	-	-	228-230
Road Zeppelin® Seat Pads	-	-	89	158	252
Road Zeppelin® Seats	-	-	-	-	244
Rockford Fosgate Audio	-	-	-	-	548-560
Rockford Fosgate Road King Audio	-	-	-	-	556
Saddlebag Guard Kits	-	-	-	132, 174	270, 273
Saddlebag Liners	23	-	-	653	653
Saddlebag Lock Kits	-	709	709	709	709
Saddlebags	22	70	-	128-131, 166-169	668
Scratch & Swirl Repair	695	695	695	695	695
Screamin' Eagle – Twin Cam	-	-	370	370	370
Screamin' Eagle Suspension	-	-	-	-	290
Screamin' Eagle® – Milwaukee-Eight™	-	-	-	334	334
Screamin' Eagle® – Sportster®	-	394	-	-	-
Seat Pads	-	-	89	121	252-253
Seats	18, 32	18, 32	18, 32	18, 32	18, 32
Security Systems	41	710	710	710	710
Service Covers	-	703	703	703	703
Service Lifts	705	705	705	705	705
Shift Levers	-	-	98	138, 170	283
Shift Linkages/Covers	-	75	-	139, 172	281
Shocks	-	-	97	134, 177	290-293
Sissy Bar Bags	-	649-653	649-653	649-653	649-653
Sissy Bar Uprights	34	65	92	124-125, 161	256
Spark Plugs	29	722	722	722	722
Speakers	-	-	-	-	548-574
Speedometer/Tachometer Gauges	-	588	587-590	587-590	587-590
Spoilers	-	-	-	-	666
Spray Cleaner & Polish	694	694	694	694	694
Stage Kits	-	403-404	385	354, 356-365, 385	354, 356-365, 385
Storage Covers	702	702	702	702	702
Street Tuner	-	332	332	332	332
Sun Ray® Heated Seats/Backrests	-	-	-	-	264
Sundowner™ Seats	18	61	-	118, 154	243, 246
Sunwash® Bike Soap	694	694	694	694	694
Suspension Air Pumps	-	-	-	-	293
Suspension Kits	-	-	97	134, 177	290-293
Swingarm Bags	-	71	-	131, 167	-
Swingarm Pivot Bolt Covers	41	76	-	184	-
Switch Cap Kits	-	513	513	513	513
Switch Housing Kits	-	512	512	512	512

Product	REVOLUTION MAX®	SPORTSTER®	DYNA®	SOFTAIL®	TOURING
SYN3® Synthetic Oil	29	685	685	685	685
Tail Bag	35	-	-	-	-
Tail Lamps – LED	-	613	613	613-618	622-623
Tallboy® Seats	18	-	87	116	242
Tank Bag	25	-	-	-	-
Tank Knee Pads	16	-	90	122	-
Tappets	-	402	383	383	383
Timer Covers	-	424-441	424-441	424-441	424-441
Tire Pressure Gauges	724	724	724	724	724
Tire Pressure Monitoring System	28	-	-	-	724
Tires	739	730-731	730-731	730-731	730-731
Tool Kits	28	718-719	718-719	718-719	718-719
Top Case Mounts - Pan America	24	-	-	-	-
Top Cases - Pan America	22	-	-	-	-
Tour-Pak – King	-	-	-	-	672
Tour-Pak – Leather	-	-	-	133, 169	-
Tour-Pak Brake/Tail Lamp Kit	-	-	-	-	622-623
Tour-Pak Conversion Kit	-	-	-	-	268
Tour-Pak Hinges/Latches	-	-	-	-	312-314
Tour-Pak Liners	23	-	-	-	274-276
Tour-Pak Mounting Rack	-	71	-	133, 169	266-268
Tour-Pak® – Chopped	-	-	-	-	672
Transmission and Primary Lubricant	-	685	685	685	685
Travel-Paks	23	-	-	653	653
Trunk Guard	-	-	-	-	324
Turn Signal Lens Kit	-	611, 616	611, 616	611, 616	611, 616
Turn Signal Trim Rings	-	611	611	611	611
Turn Signals – LED	-	611-616	611-616	611-616	611-616
USB Charging Adaptors	-	586	586	586	586
Valve Springs	-	-	383	365, 383	365, 383
Ventilator Air Cleaner	-	-	375	340, 375	340, 375
Wheel and Tire Cleaner	694	694	694	694	694
Wheel Installation Kits	28	641	641	641	641
Wheels	28	-	-	640	634-639
Windshield Bags	-	654-655	654-655	654-655	654-655
Windshield Trim	-	-	-	-	226, 230-231
Windshields	16, 30	-	-	-	-
Wireless Headsets	577	577	577	577	577
Wireless Interface Module	-	-	-	-	578

93936	676	14100618	188, 304	16200086	418	25400117	382	25600125	368	25700505	436
98625	696	14100747	305	16200091	418	25400125	402	25600127	368	25700506	436
10400049	122, 159, 249	14100748	305	16200092	418	25400199	355	25600129	368	25700520	438
10400069	367	14100749	305	16200095	418	25400200	355	25600132	368	25700532	450
10500093	63, 90, 122, 159, 249	14101218	679	16200096	418	25400201	355	25600133	430	25700631	442
10800056	677	14101219	679	16200103	418	25400202	355	25600134	430	25700633	300
10800057	677	14101220	677	16200104	418	25400353	355	25600135	430	25700634	300
10800058	677	14101385	424	16200105	418	25600046	436	25600142	441	25700638	438
11100078	325	14101386	425	16200106	418	25600047	436	25600148	428	25700653	449
11100080	325	14101389	424	16200108	418	25600064	434	25600150	428	25700654	442
11100098	325	14101390	425	16200109	418	25600065	435	25600152	428	25700740	432
11100125	325	14101393	424	16200162	418	25600066	433	25600153	368	25700742	432
11100222	111	14101394	425	16200163	418	25600067	437	25600154	368	25700744	432
11100225	111	14101398	40, 427	16200164	418	25600068	431	25600156	426	25700750	438
11300002	691	14101402	40, 427	16200339	411	25600085	432	25600171	424	25700887	429
11300004	717	14101443	426	16200340	411	25600087	432	25600172	425	25700888	429
11300005	690	14101445	426	16200341	412	25600089	432	25600176	439	25700890	443
12600036	69, 93, 165, 255	14101557	40, 427	16200342	412	25600097	440	25700020	441, 444	25700913	438, 439
12600251	462	14101615	426	16200521	411	25600098	438	25700180	444	25700934	439
12600252	462	14101831	678	16200522	411	25600099	436	25700337	447	25700937	439
12600253	462	14101832	678	16400020	453	25600108	429	25700385	446	25700941	439
12600254	462	14101833	678	16400055	449	25600109	429	25700388	440	25700958	433
12600255	462	14101834	678	16400056	443, 449	25600114	429	25700434	434	25700959	431
12600256	462	14101835	678	17900032	383	25600115	429	25700435	435	25700960	434
12600257	462	14101836	678	17900033	383, 449	25600117	368	25700438	444	25700961	437
12600258	462	14900033	719	17900058	356	25600118	368	25700467	438	25700968	439
12600259	462	14900091	689	17900073	356	25600119	368	25700469	433	25700969	436
12600261	462	14900127	28, 719	17900076	383, 449	25600120	368	25700472	437	25700970	439
12600263	462	14900138	29, 689	17900081	443	25600121	368	25700476	431	25700971	438, 439
12600354	707	16200070	417	17900083	453	25600122	368	25700477	438, 441, 444	25700972	439
12700020	724	16200071	417	17900084	453	25600123	368	25700491	438	25700976	432
		16200085	418	18100080	356	25600124	368	25700504	436	25700987	429

25700988	429	26800128	236	29400221	377	29400388	338	31600190	29	33600325	283	37000026	416	41300148	143, 183	41600280	282	42400036	641	43100023	736	43300010	178
25701020	430	26800152	236	29400222	376	29400396	340	32700002	178	33600333	473	37000258	414	41300152	143, 183	41600299	479	42400038	28	43100026	730, 732	43300324	638
25701021	430	26800188	690	29400230	375	29400397	340	32700151	26	33600334	475	37000286	414	41300154	296	41600304	282	42400039	28	43100027	738	43300336	638
25701022	430	26800191	690	29400233	376	29400400	340	33600001	170, 283	33600335	476	37000287	414	41300161	723	41600305	282, 479	42400045	634	43100029	732	43300386	638
25701023	430	26800195	237	29400234	376	29400405	339	33600075	491	33600338	37, 471	37000288	414	41300169	723	41600326	37, 471	43000026	75, 146, 180, 298	43100035	733	43300589	640
25701039	439	27300139	406, 721	29400235	376	29400406	339	33600076	283	33600345	283	40100061	415	41300181	296	41600348	37, 470	43000046	75, 146, 180, 299	43100037	733	43300593	640
25701043	439	29200011	85	29400236	376	29400407	339	33600154	490	33600356	470	40900070	638	41300196	723	41600370	37, 470	43000051	185	43100039	732	43300594	640
25701077	439	29400015	720	29400237	376	29400412	340	33600164	138	33600357	470	40900346	638	41300197	723	41600371	27	43000052	185	43100041	738	43300597	640
25701164	424	29400019	406, 721	29400238	376	29400426	26, 720	33600165	138	33600383	469	40900391	638	41300214	723	41700297	514	43000055	185	43100042	739	43300640	639
25701165	425	29400020	406, 720, 721	29400239	376	29400427	26, 720	33600166	138	33600384	468	40900571	640	41500007	642	41700334	514	43000090	146	43100043	739	43300673	636
25701169	428	29400021	721	29400240	376	29400428	26	33600167	138	33600392	475	40900572	640	41500008	642	41700440	511	43000096	75, 146, 180, 299	43100045	732, 735, 738	43300674	636
25701171	428	29400042	720	29400247	406, 721	29400433	39	33600168	138	33600393	473	40900574	640	41500052	642	41700442	514	43000108	147	43100049	29, 739	43300821	28
25701173	428	29400045	720	29400248	720	29400440	39	33600180	480	33600401	27	40900622	639	41500053	642	41700463	511	43000109	147	43100063	730, 731, 732, 739	43300888	634
25701175	428	29400063	377	29400267	720	29400442	39	33600214	481	33600402	36	40900650	636	41500069	643	41700480	511	43000123	75, 146, 180, 298	43200001	734, 736	45400006	176
25701177	428	29400064	377	29400275	406, 721	29400449	26	33600215	482	33900186	281	40900651	637	41500094	642	41701018	511	43000124	75, 146, 180, 298	43200005	731	45400058	97
25701179	428	29400065	406, 721	29400276	406, 721	29400450	26	33600216	482	34800031	438	40900660	636	41500095	645	41800220	690	43000129	147, 186	43200007	730	45400218	292
25701181	40, 427	29400078	720	29400285	372	29400451	26	33600217	482	34800032	450	40900661	636	41500107	643	41800770	690	43000129	147, 186	43200011	731	45400219	292
25701209	426	29400103	377	29400293	406, 721	29400453	39	33600218	482	36700004	510	40900662	636	41500108	643	41800771	690	43000159	146	43200015	731	45500014	176
25701211	426	29400104	377	29400297	406, 721	31400088	442	33600224	139	36700052	510	40900814	28	41500109	643	41800772	690	43000177	75, 146, 180, 299	43200021	737	45500015	176
25701403	369	29400109	406, 721	29400298	341	31400090	442	33600256	489	36700064	510	40900871	634	41500110	643	41800773	690	43000178	147, 185	43200022	734	45500106	292
25701404	369	29400116	377	29400299	341	31400092	449	33600257	488	36700065	510	41000018	332	41500120	635, 639, 643	41800774	690	43000178	147, 185	43200023	738	45500157	292
25701407	369	29400117	377	29400339	432	31600012	722	33600258	485	36700067	510	41000369	517	41500147	635, 639, 643	41800822	690	43000212	75, 146, 298	43200027	733, 736	45500158	292
25701408	369	29400118	406, 721	29400341	432	31600085	407, 722	33600259	139, 172, 281	36700100	511	41001212A	332	41500154	643	41800823	690	43000214	41	43200030	730	45500167	294
25701532	424	29400127	397, 451	29400345	432	31600105	407, 722	33600292	283	36700104	510	41300004	723	41500156	643	42200007	644	43000214	41	43200039	733	45500171	294
25701533	425	29400128	397	29400355	342	31600106	407, 722	33600301	283, 479	36700105	510	41300027	723	41500161	643	42300009	725	43000215	41	43200041	738	45500200	294
25701536	424	29400141	406, 721	29400356	342	31600108	408	33600303	479	36700209	510	41300033	723	41500163	643	42300150	28	43000303	20	43200042	739	45500400	143
25701537	425	29400173	372	29400357	342	31600109	408	33600306	27	36700210	510	41300053	723	41500172	643	42400003	641	43000304	20	43200045	737	45500401	143
25800055	438	29400212	720	29400358	406, 721	31600110	408	33600313	493	36700211	510	41300061	516	41500174	643	42400008	641	43100004	730, 731	43200046	738	45500402	143
25800061	443	29400217	375	29400359	406, 721	31600111	408	33600314	139	36700271	510	41300062	516	41600079	282	42400016	296	43100008	732, 735	43200050	29, 739	45500403	143
25800098	438	29400218	375	29400363	343	31600112	408	33600318	139	36700272	510	41300072	723	41600082	282	42400033	641	43100014	736	43200054	736	45500404	143
26800120	236	29400219	375	29400366	343, 432	31600113	408	33600321	468	36700273	510	41300102	723	41600219	138	42400034	641	43100016	733	43200063		45500405	143
26800121	236	29400220	377	29400387	338	31600180	29	33600322	469	36700274	510	41300116	296	41600220	138	42400035	641	43100017	738		730, 731, 733, 734	45500406	143

750 PART#/PAGE# REFERENCE

PART#/PAGE# REFERENCE 751

45500427	134	49000231	142	50500144	72, 100, 174, 500	50500949	481	50501288	484	50501799	141	50502090	136	50600165	491	50600417	493	50700089	215	52000268	243	52000461	247
45500514	76, 181	49000232	142	50500167	502	50500967	494	50501289	485	50501800	493	50502111	476	50600232	490	50600424	477	50700093	104	52000269	62	52000463	243
45500515	76, 181	49000235	289	50500168	502	50500992	480	50501290	485	50501801	493	50502112	475	50600266	480	50600425	477	50700095	104	52000276	63, 157	52000471	18
45600022	295	49000248	20	50500225	98, 171, 280	50500993	481	50501382	477	50501819	493	50502113	473	50600267	480	50600457	472	50700096	105	52000277	62, 89, 157	52000472	18
45600023	295	50000023	280	50500247	98	50501113	140	50501383	27, 477	50501830	476	50502136	36	50600268	481	50600458	474	50700097	105	52000290	117	52000478	18
45700054	289	50000032	100	50500270	72	50501114	140	50501385	477	50501831	475	50502148	470	50600269	481	50600459	476	50700098	12	52000291	118	52000510	33
45700068	19	50000091	174	50500435	491	50501117	140	50501387	477	50501832	473	50502149	470	50600290	482	50600463	472	50700100	15	52000293	118	52000550	32
45800022	295	50000122	280	50500436	491	50501118	140	50501389	477	50501855	476	50502150	470	50600291	482	50600464	474	50700101	13	52000294	117	52000564	245
45800034	295	50000248	21	50500437	491	50501128	140	50501390	27, 477	50501856	475	50502151	470	50600292	482	50600465	476	50700102	14	52000295	119	52000566	245
45800035	295	50000263	280	50500578	284	50501142	487	50501392	477	50501857	473	50502158	483	50600293	482	50600466	472	50700104	15	52000298	118	52000567	245
45800036	295	50000264	21	50500695	135	50501143	494	50501394	477	50501895	476	50502159	483	50600294	482	50600467	474	50700109	217	52000300	118	52000571	32
45800037	295	50000276	280	50500696	135	50501144	99, 141, 286, 504	50501510	483	50501896	475	50502205	36	50600295	482	50600468	476	50700110	217	52000302	114	52100016	62
45800117	76, 181	50300030	68, 164	50500717	490	50501145	487	50501558	480	50501897	473	50502244	469	50600296	482	50600483	470	50700111	217	52000303	114	52100029	122
45800133	144	50300031	68, 164	50500718	487	50501147	99, 141, 286, 504	50501559	481	50501898	476	50502245	469	50600297	482	50600499	470	50700112	216	52000304	114	52100043	122
45800134	144	50300097	254	50500722	487	50501148	489	50501602	477	50501899	475	50502246	468	50600311	486	50600507	469	50700113	216	52000305	116	52100063	243
47200240	234	50300133	127	50500769	140	50501150	489	50501603	477	50501900	473	50502247	469	50600313	486	50600508	468	52000011	154	52000315	122	52200004	708
47200278	303	50300136	127	50500771	140	50501151	489	50501604	477	50501932	476	50502248	468	50600317	494	50600509	469	52000015	88	52000327	89, 121, 158, 252	52300018	64, 92, 161
47200732	20	50300140	127	50500840	135	50501197	483	50501605	477	50501933	474	50502249	468	50600318	494	50600510	468	52000057	248	52000334	240	52300020	64, 92, 161
47200927	142	50300174	133	50500856	486	50501225	488	50501610	99, 141, 286, 504	50501934	472	50502250	469	50600338	490	50600511	468	52000062	60	52000334	240	52300022	64, 92, 161
47500047	41	50300176	133	50500858	486	50501227	488	50501612	477	50501938	474	50502251	468	50600340	489	50600512	469	52000072	245	52000349	119	52300024	92
49000005	74	50300186	133	50500870	480	50501228	488	50501611	99, 141, 286, 504	50501939	472	50502252	469	50600341	488	50600517	474	52000075	245	52000350	119	52300038	162
49000006	74	50300188	133	50500871	480	50501228	488	50501612	477	50501945	476	50502253	469	50600342	484	50600518	472	52000128	246	52000352	115	52300103	89, 121, 158, 253
49000069	324	50300192	133	50500872	481	50501228	488	50501612	477	50501950	476	50502254	468	50600343	484	50700001	656	52000183	246	52000353	115	52300140	656
49000077	101	50300292	34	50500873	481	50501265	490	50501613	477	50501951	474	50502255	468	50600344	484	50700005	98	52000201	244	52000354	115	52300140	656
49000078	101	50300295	254	50500874	481	50501266	490	50501640	137	50501952	472	50502256	468	50600345	484	50700020	73	52000203	61	52000355	116	52300239	160
49000138	142	50500035	496	50500874	481	50501281	484	50501642	282	50501979	468	50502257	469	50600346	480	50700021	73	52000207	60	52000381	122	52300245	63
49000139	142	50500042	284	50500874	481	50501282	484	50501644	478	50501980	469	50502338	475	50600347	481	50700028	73	52000248	248	52000391	113	52300257	257
49000140	142	50500109	72, 100, 174, 500	50500937	482	50501283	485	50501679	478	50501988	136	50502339	473	50600365	482	50700040	73	52000249	248	52000398	115	52300258	257
49000141	142	50500124	72, 100, 174, 500	50500938	482	50501284	485	50501680	478	50502020	40, 471	50502353	475	50600366	482	50700061	135	52000252	242	52000399	119	52300300	259
49000191	20	50500139	72, 100, 174, 500	50500939	482	50501285	485	50501684	478	50502026	40, 471	50502354	473	50600367	482	50700085	214	52000253	240	52000400	113	52300312	264
49000192	21	50500139	72, 100, 174, 500	50500940	482	50501286	485	50501716	478	50502040	136	50502434	37	50600368	482	50700086	214	52000257	247	52000430	114	52300314	264
49000194	31	50500139	72, 100, 174, 500	50500947	480	50501287	485	50501796	493	50502041	136	50600159	491	50600401	479	50700088	215	52000259	62	52000452	247	52300317	264

52300319	265	52300567	265	52400196	113	53000405	672	55800440	540	55801060	536	56000029	308, 506	56100036	497	56100364	484	57001627	106, 675	57400093	228	57400319	58
52300353	255	52300572	265	52400197	113	53000431	278	55800563	520	55801061	536	56000039	509	56100048	492	56100394	478	57100179	185	57400110	151	57400320	230
52300354	255	52300573	259	52400204	119	53000459	267	55800568	540	55801062	539	56000042	509	56100108	491	56100401	19	57100210	234	57400111	151	57400323	108
52300359	265	52300574	265	52400225	120	53000570	133	55800569	540	55801063	539	56000076	308, 506	56100112	491	56100402	19	57100211	74	57400112	151	57400324	110
52300360	265	52300642	251	52400249	18	53000598	133	55800579	525	55801263	38, 522	56000077	308, 506	56100218	490	56100411	493	57100212	85	57400114	151	57400327	109
52300361	259	52300643	123	52400251	33	53000751	23	55800587	524	55801280	38, 522	56000080	506	56100231	480	56100412	499	57100213	175	57400115	151	57400328	111
52300364	65	52300644	123	52400271	33	53000800	25	55800589	535	55801284	527	56000081	506	56100232	480	56100427	476	57100227	303	57400120	83	57400329	111
52300366	65	52300645	123	52400288	32	53000814	22	55800590	535	55801308	522	56000084	308, 506	56100234	481	56100428	474	57100233	667	57400143	153	57400330	110
52300401	161	52300646	123	52400306	32	53000816	22	55800591	535	55801309	522	56000090	508	56100235	481	56100429	472	57100258	667	57400150	231	57400331	109
52300403	65	52300700	34	53000063	269	53000847	25	55800592	535	55801311	530	56000135	508	56100253	498	56100436	498	57100270	234	57400159	152	57400332	111
52300409	117	52300702	34	53000130	313	53000862	23	55800714	521	55801313	530	56000136	508	56100255	499	56100437	498	57100297	77	57400176	220	57400334	108
52300415	254	52300705	34	53000131	312	53000917	268	55800715	520	55801315	531	56000137	508	56100256	498	56100438	498	57100366	142	57400204	222	57400335	111
52300432	124	52300715	33	53000195	313	54000008	293	55800717	520	55801317	531	56000171	508	56100257	499	56100446	474	57200139	79	57400205	222	57400336	109
52300434	124	52400039	156	53000217	313	54000016	76	55800719	521	55801324	531	56000220	38, 507	56100259	499	56100447	472	57200140	79	57400206	222	57400337	109
52300435	124	52400040	248	53000218	313	54000017	76	55800721	521	55801325	531	56000221	38, 507	56100260	499	56100448	468	57200157	235	57400224	223	57400345	59
52300437	124	52400053	61	53000221	267	54000041	177	55800852	542	55801326	530	56000224	38, 507	56100261	499	56100449	469	57200159	79	57400225	223	57400360	111
52300439	124	52400090	249	53000225	266	54000066	97	55800854	542	55801327	530	56000225	38, 507	56100264	499	56100462	40, 471	57200258	21	57400226	223	57400367	110
52300441	124	52400091	249	53000229	270	54000077	74	55800856	523	55801330	525	56000241	40	56100266	499	56100477	470	57200347	36	57400227	223	57400368	110
52300442	124	52400121	61	53000237	313	54000091	293	55800858	523	55801332	532	56000261	38, 507	56100267	499	56100478	470	57200356	235	57400228	223	57400369	111
52300446	124	52400125	63	53000242	270	54000134	134	55800861	523	55900023	544	56000262	507	56100268	499	56100479	483	57300065	90, 122, 159	57400229	224	57400380	219
52300448	124	52400127	63	53000247	270	54000143	134	55800863	537	55900074	522	56000263	508	56100318	498	56100483	19, 40, 471	57300149	149, 591	57400243	224	57400381	219
52300454	124	52400128	120	53000252	312	54000159	293	55801003	527	55900122	543	56000279	507	56100319	489	56100487	19	57300151	149, 592	57400256	230	57400383	219
52300456	124	52400129	120	53000253	312	54000193	291	55801004	536	55900123	543	56000280	507	56100330	483	56100488	19	57300165	149, 592	57400270	228	57400454	16
52300502	125	52400140	248	53000302	275	54000294	134	55801006	539	55900165	544	56000294	507	56100331	498	56100544	468	57300186	149, 592	57400271	228	57400456	16
52300503	125	52400141	248	53000303	276	55800103	526	55801007	539	55900166	543	56000301	507	56100332	488	56100545	469	57300213	145	57400274	221	57400459	31
52300504	125	52400162	89, 121, 158,	53000322	274	55800188	527	55801015	528	55900194	542	56000305	507	56100342	498	57000063	235	57300214	145	57400279	228	57400479	30
52300513	127, 709		252	53000323	274	55800198	526	55801016	528	55900227	542	56100007	497	56100355	497	57000307	325	57300216	149, 591	57400280	229	57400492	30
52300514	127, 709	52400168	120	53000329	312	55800345	524	55801029	528	55900228	542	56100008	497	56100356	490	57000510	235	57300236	149, 592	57400281	228	57400499	16
52300518	127, 709	52400169	120	53000330	312	55800421	526	55801030	528	55900237	542	56100009	497	56100358	498	57000529	225	57300289	145	57400294	230	57400503	110
52300519	127, 709	52400170	120	53000343	312	55800430	526	55801057	529	55900238	542	56100010	497	56100361	484	57001234	666	57300291	16	57400299	230	57400505	110
52300557	126, 258	52400171	120	53000392	275	55800431	526	55801058	529	55900241	19	56100015	497	56100362	499	57001249	106, 675	57400091	222	57400310	229	57400526	229
52300560	126, 258	52400186	120	53000404	672	55800439	540	55801059	529	55900297	21	56100034	499	56100363	499	57001250	106, 675	57400092	222	57400318	58	57400528	224

57400536	59, 709	61300218	435	61301045	630	61400374	659	62600019	685	62600139	687	64901190	348	65400460	349	66000347	716	67800615	624	67900007	626	68000213	597
57400630	221	61300254	431	61301177	630	61400375	659	62600021	683	62600140	686	64901191	348	65400461	349	67700059	601	67800616	624	67900008	319, 627	68000214	597
57400631	221	61300275	226	61301326 344, 439, 454		61400377	659	62600023	684	62600141	686	64901192	347	65400464	380, 400	67700109	601	67800617	624	67900056	319, 627	68000218	596
58900319	665	61300299	378	61301327 344, 439, 454		61400399	307	62600024	684	62700009	79, 456	64901193	347	65400466	348	67700112	601	67800639	616	67900058	319, 627	68000252	602
58900590	665	61300310	227	61400001	309	61400411	663	62600025	690	62700011	79, 456	64901205	350	65400468	348	67700115	608	67800640	616	67900130	96	68000253	602
59500766	148	61300358	226	61400002	447	61400437	145	62600026	690	62700015	689	64901208	350	65400472	349	67700116	608	67800642	616	67900273	319, 627	68000312	317, 623
59500767	148	61300452	630	61400025	437	61400440	145	62600027	690	62700045	688	65100016	353, 381	65400480	349	67700117	608	67800643	616	67900275	319, 627	68000313	317, 623
59500769	148	61300505	663	61400028	235	61400451	306	62600033	685	62700055	688	65100017	353, 381	65400481	349	67700215	606	67800644	616	67900645	628	68000340	17, 605
59500770	148	61300516	375, 454	61400058	271	61400455	437	62600060	684	62700082	78	65100019	353, 381	65400648	27	67700216	607	67800645	616	67900653	628	68000341	605
59500771	148	61300517	375, 454	61400148	458	61400509	144	62600082	684	62700180	456	65100044	379, 400	65400681	39	67700439	602	67800706	302, 612	68000042	605	68000342	605
59600018	324	61300536	454	61400176	458	61400573	145, 608	62600083	684	62700194	456	65100062	353, 381	65600155	400	67700487	608	67800707	302, 612	68000076	68, 95, 164	68000343	17, 605
59600022	302	61300542	436	61400193	307	61400574	608	62600087	684	62700199	689	65100063	379, 400	65600330	352	67800061	613	67800977	617	68000090	603	69000007	80, 629
60300196	77	61300621	630	61400194	308	61400593	226	62600088	684	62700204	236	65100078	351	65600331	352	67800133	624	67800980	617	68000092	603	69000009	80, 629
60800005	101	61300622	631	61400197	308	61400617	658	62600091	685	62700239	689	65100085	351	65600332	352	67800166	605	67800982	617	68000104	598	69000038	703
61100076	149	61300623	630	61400201	306	61400721	659	62600093	685	62700280	29	65100153	347	65600389	26	67800167	612	67801023	316, 622	68000105	624	69000058	101
61100106	81, 592	61300654	433	61400205	659	61400722	659	62600094	685	62700296	688	65100160	348	66000005	716	67800355	624	67801024	316, 622	68000111	261, 262	69000124	41
61100131	149, 591	61300656	437	61400206	658	61400723	659	62600098	690	62700297	688	65100161	348	66000107	710	67800356	624	67801080	316, 622	68000112	269	69200091	321, 583
61100132	149, 591	61300762	345	61400210	307	62400260	367	62600099	29, 683	64900334	379	65100165	348	66000130	716	67800357	624	67801082	316, 622	68000113	269	69200357	321, 586
61100133	149, 591	61300768	341	61400224	226	62400264	367	62600100	29, 683	64900341	379	65100166	348	66000147	716	67800358	624	67801128	317, 623	68000114	271	69200441	604
61100134	149, 591	61300769	341	61400292	609	62500026	144	62600101	29, 683	64900343	379	65100196	351	66000301	717	67800374	618	67801129	317, 623	68000115	271	69200442	604
61100136	149, 591	61300770	341	61400293	609	62600004	685	62600102	29, 683	64900476	399	65100205	351	66000302	717	67800375	618	67801147	614	68000116	261, 262	69200722	322, 586
61100158	149, 591	61300788	344, 454	61400294	609	62600005	683	62600111	684	64900477	399	65100216	348	66000303	717	67800452	619	67801148	614	68000129	324	69200772	261, 262
61100180	149, 592	61300792	431	61400295	609	62600007	684	62600112	684	64900636	347	65100217	348	66000304	715	67800477	613	67801149	615	68000141	603	69200826	321, 583
61100188	27	61300794	311	61400296	306	62600008	684	62600123	686	64900638	347	65100218	348	66000305	715	67800478	613	67801150	615	68000142	603	69200854	320, 583
61100210	149, 591	61300811	144	61400298	306	62600009	684	62600128	686	64900690	347	65100219	351	66000306	715	67800483	318, 621	67801151	615	68000151	319	69200855	320, 583
61100211	149, 591	61300828	345, 455	61400311	305	62600010	685	62600131	686	64900691	347	65100220	351	66000307	715	67800484	318, 621	67801152	615	68000152	319	69200863	603
61300057	343, 434	61300845	343	61400312	305	62600011	683	62600132	686	64900752	348	65100221	351	66000308	715	67800492	318, 621	67801184	614	68000170	603	69200864	603
61300109	374	61300846	343	61400323	343, 436	62600013	684	62600134	687	64900754	348	65400078	401	66000309	715	67800493	318, 621	67801186	614	68000171	603	69200865	576
61300110	374	61300928	429	61400325	227	62600014	684	62600135	687	64900756	348	65400405	380, 400	66000310	715	67800494	318, 621	67801297	35	68000172	600	69200907	576
61300120	344, 455	61300993	340	61400328	307	62600015	683	62600136	687	64900758	348	65400457	349	66000312	715	67800554	625	67801326	615	68000173	600	69200970	320, 583
61300128	344, 455	61300994	340	61400334	307	62600017	684	62600137	687	64900828	346	65400458	349	66000313	715	67800555	625	67801327	615	68000183	603	69200971	320, 583
61300217	433	61301005	430	61400339	343	62600018	684	62600138	687	64900829	346	65400459	349	66000319	715	67800614	624	67801329	615	68000184	603	69201108	603

69201109	603	71400106	322	76000749	574	76000988	552	90200876	271	90202254	35	92500080	363	93100017	706	93300105	649	93600056	699	93600171	694	25338-99B	431
69201148	586	71400129	322	76000751	574	76000989	552	90200882	276	90202332	130	92500081	363	93100018	701, 702	93300106	650	93600068	695	12700096A	724	25340-99A	437
69201149	586	71500110	513	76000768	578	76000990	553	90200914	314	90202530	35	92500082	363	93100019	701, 702	93300107	132, 653	93600080	696	16205-10	449	25364-01B	445
69201150	586	71500177	513	76000842	576	76000991	552	90200915	314	90202531	35	92500083	358	93100020	701, 702	93300110	132, 653	93600081	696	16213-10	443, 449	25369-01B	446
69201525	597	71500178	513	76000862	585	76000992	549	90200918	274	90300003	167, 709	92500084	359	93100021	701, 702	93300112	654	93600082	695	16295-07A	452	25440-04A	433
69201529	597	71500179	513	76000863	585	76000997	553	90200981	272	90300017	167, 709	92500086	359	93100022	701, 702	93300113	654	93600083	696	17537-07A	452	25441-04A	433
69201530	597	71500185	512	76000947	566	76001045	554	90200991	277	90300111	710	92500094	364	93100023	701, 702	93300114	654	93600084	694	17537-96C	452	25454-01	441
69201594	597	71500285	513	76000950	565	76001046	554	90200992	279	90300117	710	92500095	365	93100024	701, 702	93300116	653	93600107	698	17551-04	452	25460-04	452
69201595	597	71500286	513	76000951	573	76001071	582	90201052	314	90300118	712	92500096	358	93100025	701, 702	93300117	653	93600110	698	17572-99	446	25460-06	452
69201625	597	71500441	513	76000952	573	76001072	582	90201084	314	91600001	691	92500097	358	93100026	701, 702	93300119	652	93600115	696	17573-99A	446	25482-10	382
69201636	597	71500442	512	76000953	566	76001074	556	90201107	668	91800029	645	92500121	442	93100027	701, 702	93300120	652	93600121	694	17618-99A	445	25486-05	451
69201704	333	71500515	513	76000954	572	76001082	581	90201108	669	91800030	179	92500122	442	93100028	703	93300121	652	93600122	694	17620-99	445	25562-09	434
69201706	322, 586	71500517	513	76000955	571	76001100	552	90201109	669	91800066	456	92500127	354	93100034	713	93300122	652	93600123	695	17645-07A	451	25563-09	434
69201726	578	71500561	516	76000956	571	76001113	556	90201206	315	92500011	392	92500128	354	93100040	701	93300123	650	93600124	695	17655-05	451	25638-07	382
69201750	586	71500629	516	76000957	572	76001137	581	90201312	132	92500028	386	92500129	354	93100041	701	93300124	650	93600125	695	17707-11	444	25913-99	461
69202757	17	76000193	657	76000959	565	76001163	555	90201315	132	92500031	391	92500130	354	93100042	702	93300125	650	93600126	694	17709-11	444	26082-05C	237
69202993	41	76000259	584	76000960	565	76001164	555	90201321	70	92500032	391	92800008	69, 93, 165, 255, 709	93100043	701, 702	93300126	651	93600127	695	17964-99	446	26151-07B	101
70900078	588	76000280	564	76000961	565	76001178	579	90201324	71	92500033	391	92800012	707	93100070	25, 701	93300128	35	93600129	694	17966-99	446	26155-09A	237
70900176	589,590	76000351	576	76000974	554	76001179	579	90201433	71	92500035	387	92800013	707	93100073	701, 702	93300129	25	93600130	697	18013-03A	383, 402	26157-07A	187
70900274	78, 587	76000505	567	76000975	554	76001180	580	90201558	129	92500038	390	92800018	708	93100074	701, 702	93300142	24	93600132	698	18404-08	383	26157-11A	187
70900283	590	76000512	575	76000976	554	76001339	582	90201567	131, 167	92500041	404	92800019	708	93300001	275	93300158	651	93600133	697	18572-13	383, 402	27539-08A	389
70900284	590	76000523	564, 570	76000977	551	76001340	582	90201568	131, 167	92500042	404	92800020	708	93300060	278	93300159	650	93600136	698	19221-15	413	27543-08	388
70900463	310	76000539	231	76000978	551	76001341	582	90201768	168	92500047	354	92900001	705	93300061	278	93300168	652	93600140	694	24017-10	384	27557-08	388
70900475	78, 587	76000549	582	76000979	550	76001342	583	90201769	70, 132, 169	92500054	393	92900002	705	93300062	278	93500006	179, 303	93600141	694	24018-10	384	27564-09A	388
70900501	310	76000584	574	76000980	549	76001343	583	90201770	70, 132, 168	92500055	393	92900004	705	93300063	278	93500011	303	93600155	695	25127-04A	437	27794-08	722
70900709	593	76000585	574	76000981	549	76200037	144, 556	90201777	132	92500058	354	92900042	705	93300070	277, 653	93600002	695	93600156	695	25130-04A	431	27956-10	343, 435
70900774	589	76000586	574	76000982	549	90200737	271	90201973	23	92500059	438	92900043	705	93300072	277, 653	93600016	697	93600162	694	25213-04	452	28714-10	406, 721
70900775	589	76000617	567, 574	76000983	549	90200787	272	90202082	22	92500074	354	92900066	21	93300097	233	93600028	696	93600166	696	25282-11	384	28720-10	374
70900781	593	76000618	574	76000984	551	90200788	272	90202087	25	92500075	354	93100005	704	93300098	251	93600029	694	93600167	695	25284-11	384	28721-10	375
70900817	145	76000734	572	76000985	551	90200791	273	90202088	22	92500077	361	93100015	704	93300099	653	93600031	695	93600168	698	25307-06	451	28722-10	375
70900843	311	76000745	574	76000986	550	90200792	271	90202107	24	92500078	361	93100016	704	93300103	649	93600033	696	93600169	696	25331-10	435	28728-10	378, 398
71400105	322	76000748	564	76000987	550	90200793	271	90202220	23	92500079	363	93100016	704	93300104	649	93600034	696	93600170	695	25333-10	435	28739-10A	374, 396

45310-98	176	46646-05	645	49021-09	98	50177-95	495	50501295A	481	51060-08	280, 504	51676-97A	63, 90, 122, 159, 249	52300617A	126	52729-08A	162	53000399EKA	672	53000402ESS	672	53000731ELE	672
45355-06B	511	46647-05	645	49023-02A	175	50193-96	287, 505	50501388A	477	51074-10	89	51726-05	246	52347-97	66, 94, 163	52760-11	162	53000399EKG	673	53000402ETF	672, 673	53000736ELE	672
45355-08A	511	46944-07A	510	49037-05A	175	50194-96	505	50501395A	477	51076-10	121, 158, 253	51727-05A	260	52348-97	66, 94, 163	52825-05	126, 259	53000399EKP	672	53000402EUZ	672	53000775DH	673
45500172B	294	47300-88T	184	49050-09A	288	50198-97C	284	50502192A	37	51078-10	89, 121, 158, 253	51732-10	65, 94	52378-07	88	52866-06A	92	53000399ENT	672, 673	53000402EVA	672, 673	53000775EGZ	672
45591-02	178, 295	47498-09	315	49053-04A	72	50203-04	72	50602-00A	173			51736-07	61	52395-03B	264	52886-98D	260	53000399ENV	673	53000402EVD	672, 673	53000775ENT	673
45800038B	295	47596-91B	186	49060-04	74	50210-06	100	50631-04	492			51737-07	60	52408-07A	258	52892-98B	264	53000399ENX	672	53000402EWZ	672	53000775ENV	673
45813-03	182, 297	47612-08	184	49080-06A	98	50211-04	492	50683-04	504			51763-07	156	52412-79A	66, 94, 163	52898-98A	265	53000399ESH	672	53000574ECL	672	53000775ENX	672
45848-03	182, 297	47630-09	184	49087-01	273	50246-00	287, 505	50688-04	504			51764-06	154	52423-09A	250	52900-09A	251	53000399ESK	672	53000643EEM	673	53000775ENZ	672
45896-98	315	47660-09	184	49102-86T	500	50300008A	262	50704-04	487			51804-02	159	52447-96	253	52912-00	156	53000399ESN	672	53000649EGZ	674	53000775EOB	673
45963-97	178, 295	47663-09	184	49110-98	501	50300042A	263	50710-04	487			51902-09	157	52501-09A	250	52914-09A	251	53000399ETF	672, 673	53000649EJD	674	53000775EOE	672
46089-98B	708	47951-10A	639	49128-82	501	50300044B	261	50713-04	487			51985-08	155	52540-09A	161	52915-07	156	53000399EVA	672, 673	53000649EJH	674	53000775ESC	672
46098-98	512	48035-09	69, 93, 165, 459	49140-05B	175	50300054A	263	50716-04	99, 141, 286, 505			52000211A	62	52544-05A	241	52920-98B	260	53000399EVD	672, 673	53000650ERP	674	53000775ESH	672
46099-98	512			49144-86	500	50300058A	263					52004-25	157	52546-09A	250	52924-98B	260	53000402BYM	672	53000651EHA	674	53000775ESN	672
46129-98B	181	48211-08	184	49149-84A	501	50300076B	261	50752-04	99, 141, 286, 505			52066-97C	247	52572-09A	251	52930-05	156	53000402DH	673	53000651EJB	674	53000775ESU	672
46302-01	172	48212-08	184	49155-05B	288	50300099A	165					52067-08A	247	52583-09A	251	52933-97C	256	53000402DWC	673	53000651EJC	674	53000775ESW	672
46303-01	281	48218-10	69, 93, 165, 459	49155-09B	288	50300124A	127	50763-09	72, 100, 284, 503			52093-08A	246	52587-09	251	52952-97	253, 703	53000402DZT	673	53000652EGZ	674	53000775ETF	672, 673
46305-01	281	48220-10	69, 93, 165, 459	49179-09	273	50300125A	127	50768-07A	285			52095-08A	247	52589-09A	251	52975-05	242	53000402ECN	672	53000652EJD	674	53000775EUZ	672
46318-04	707			49184-09A	288	50300126A	127	50782-91	287, 505			52099-09A	242	52591-09A	250	52976-05	242	53000402EFC	672	53000652EJH	674	53000775EVD	672, 673
46363-11	723	48221-10	69, 93, 165, 459	49200-07A	175	50300127A	127	50789-99B	285			52124-09A	92	52593-09A	250	53000375EGA	673	53000402EFF	673	53000653ERP	674	53000775EVI	672
46399-05A	76			49215-07	74	50300130A	127	50807-08	99, 141, 287, 505			52265-01A	247	52596-09A	250	53000375EOO	673	53000402EFH	673	53000653EUD	674	53000776DH	673
46418-05B	511	48223-10	69, 93, 165, 459	49261-00A	174	50300131A	127	50810-08	99, 141, 287, 505			52284-06	88	52609-05	241	53000399BYM	672	53000402EFP	673	53000653EUF	674	53000776EGZ	672
46424-05B	514	48225-10	69, 93, 165, 459	49282-09B	272	50357-04	99, 141, 286, 505	50829-07A	502			52292-00A	155	52610-09A	256	53000399DWH	673	53000402EFU	672	53000654EHA	674	53000776ENT	673
46425-05A	515			49283-09	273			50830-07A	502			52300040A	65	52612-95	66, 94, 163	53000399DWC	673	53000402EGZ	672	53000654EJC	674	53000776ENV	673
46463-08	515	48434-05A	77	49287-11	74	50370-04	486	50829-07A	502			52300046A	93	52626-04	66, 94, 163	53000399DZN	672	53000402EKG	673	53000660ELH	673	53000776ENX	672
46477-00	176	48452-00	184	49291-07	272	50378-07B	286	50830-07A	502			52300070A	92	52627-09A	256	53000399DZW	672	53000402EKP	672	53000662ELF	673	53000776EOB	673
46482-00	176	49000105A	289	49312-10	494	50379-07B	286	50832-07A	503			52300141A	259	52631-07	65, 93, 162	53000399EFC	672	53000402ENT	672, 673	53000662ELH	673	53000776EOE	672
46546-03	294	49000114A	289	49320-09	101	50399-07A	173	50911-08A	496			52300324A	254	52652-04	66, 94, 163	53000399EFD	673	53000402ENV	673	53000663EJB	674	53000776ESC	672
46548-03	273	49000117A	289	49440-10	175	50420-05	492	50915-90T	501			52300555A	126	52657-04B	260	53000399EFF	673	53000402ENX	672	53000699EJE	674	53000776ESH	672
46549-03	288	49004-00A	175	49442-10A	288	50454-09	174	50916-90T	501			52300556A	126, 258	52709-97C	260	53000399EFH	673	53000402EOG	673	53000699EJF	674	53000776ESN	672
46555-03B	608	49004-90	175	50130-95A	495	50459-06	173	50932-08	173			52300558A	126, 258	52710-07	64	53000399EFP	673	53000402ESH	672	53000700EJE	674	53000776ESU	672
46559-03	303	49010-06	101	50131-95A	495	50500-03	495	50957-02C	502			52300559A	126, 258	52715-04A	173	53000399EFU	672	53000402ESK	672	53000716EJF	674	53000776ESW	672
46565-04	272	49018-88C	74	50176-95	495	50500403A	284	50964-98	503			52723-06A	256	53000399EGZ	672	53000402ESN	672	53000731ELD	672	53000776ETF	672, 673		

53000776EUZ	672	53000866EXN	673	53302-07	274	54097-10	91	55192-10	730	56567-86B	545	57000388DH	670	57000389ESC	670	57000482EUZ	671	57001042EXF	666	57100257ENZ	667	57200261ENX	666
53000776EVD	672, 673	53000867EOU	673	53303-07A	268	54099-10	250	55193-10	730, 731	56626-99	654	57000388EEN	670	57000389ESH	670	57000482EVA	671	57001042EXU	666	57100257EOB	667	57200261EOR	666
53000776EVI	672	53000867ESZ	673	53472-09A	263	54145-10	280	55798-10A	510	56740-04	486	57000388EFF	670	57000389ESN	670	57000482EVD	671	57001615DH	106, 675	57100257EOW	667	57200261EPB	666
53000776EWZ	672	53000867EVO	673	53512-07A	69	54157-10	285	55800035A	522	56740-08	486	57000388EFP	670	57000389ESS	670	57000482EVG	671	57001615EGZ	106, 675	57100257EPB	667	57200261ESH	666
53000776EXE	672	53000867EVR	673	53528-95B	64	54171-11	313	55800548A	538	56741-04	486	57000388EKA	670	57000389ESW	670	57000482EWI	671	57001615EKP	106, 675	57100257ESC	667	57200261ESK	666
53000776EXF	672	53000867EXN	673	53529-04	64	54187-10	494	55800549A	538	56746-08	496	57000388ELD	670	57000389ETF	670	57000482EWX	671	57001615EKR	106, 675	57100257ESH	667	57200261ESN	666
53000777EOY	673	53000900EOU	673	53532-02	64	54205-09A	255	55800550A	538	56751-04	486	57000388ELG	670	57000389EUZ	670	57000482EWZ	671	57001615ENR	106, 675	57100257ESK	667	57200261ESS	666
53000777EPA	673	53000900ESZ	673	53544-04	64	54213-09A	263	55800551A	538	56902-08	532	57000388ENX	670	57000389EVD	670	57000482EXB	671	57001615ENT	106, 675	57100257ESN	667	57200261ESU	666
53000778EOY	673	53000900EVO	673	53566-09A	263	54215-09A	263	55900157B	530	56916-07	543	57000388EOG	670	57000389EWI	670	57000482EXE	671	57001615ENX	106, 675	57100257ESS	667	57200261ETF	666
53000778EPA	673	53000900EVR	673	53605-97	277, 653	54234-10A	502	55914-98	535	56929-10	543	57000388EOX	670	57000389EWX	670	57000482EXF	671	57001615EOB	106, 675	57100257ESW	667	57200261EUZ	666
53000779EOW	673	53000900EXK	673	53655-04A	71	54246-09A	255	55954-00	533	57000387DH	670	57000388EPB	670	57000389EWZ	670	57000482EXU	671	57001615EOG	106, 675	57100257ETF	667	57200261EVA	666
53000779EOX	673	53000901EOU	673	53665-87	270	54247-09A	256	55967-08	525	57000387EEV	670	57000388ESH	670	57000389EXB	670	57001042DH	666	57001615EUZ	106, 675	57100257EUZ	667	57200261EVD	666
53000780EOX	673	53000901ESZ	673	53690-06A	169	54248-09A	256	56036-08	534	57000387EFF	670	57000388ESU	670	57000389EXE	670	57001042EFC	666	57001615EVC	106, 675	57100257EVA	667	57200261EVI	666
53000830ELV	674	53000901EVO	673	53797-09	91	54256-10	161	56063-82A	544	57000387EFP	670	57000388ETF	670	57000394A	227, 598	57001042EFF	666	57001615EVD	106, 675	57100257EVD	667	57200261EWI	666
53000830ELZ	674	53000901EVR	673	53803-06	255	54258-10A	161	56066-82A	544	57000387EGZ	670	57000389DH	670	57000395A	227, 598	57001042EGZ	666	57001615EXE	106, 675	57100257EVI	667	57200261EWX	666
53000830ERS	674	53000901EXK	673	53804-06	255	54263-10	164	56165-03	544	57000387ELG	670	57000389EFF	670	57000482DH	671	57001042EKG	666	57061-09	151	57100257EWI	667	57200261EWZ	666
53000830ERT	674	53000946EUI	674	53810-00C	161	54268-10	160	56166-08	533	57000387ELI	670	57000389EFP	670	57000482EFF	671	57001042EKP	666	57070-97DH	59, 85	57100257EWX	667	57200261EXB	666
53000833ELV	674	53000955EUI	674	53815-00A	161	54283-09A	262	56170-83TA	545	57000387ENR	670	57000389EGZ	670	57000482EFP	671	57001042ELG	666	57070-98	85	57100257EWZ	667	57200261EXE	666
53000833ELZ	674	53000960EUL	674	53842-00C	310	54290-11	68, 95, 164	56178-92TA	545	57000387ENV	670	57000389EKA	670	57000482EGZ	671	57001042ENT	666	57100257DH	667	57100257EXE	667	57200261EXF	666
53000833ERS	674	53000963EUL	674	53862-00	68, 95, 165	54291-11	68, 95, 164	56180-08	533	57000387ENX	670	57000389EKG	670	57000482EKA	671	57001042ENV	666	57100257DWC	667	57100257EXF	667	57200261EXU	666
53000833ERT	674	53000985EWJ	672	53913-04	64	54296-11	160	56246-08	495	57000387EOR	670	57000389EKP	670	57000482EKP	671	57001042ENX	666	57100257DZT	667	57100257EXU	667	57203-07	233, 655
53000835EML	674	53015-05B	166	53919-04B	310	54376-10B	157	56246-96A	495	57000387EOW	670	57000389EKR	670	57000482ELE	671	57001042EPB	666	57100257EFC	667	57140-05	152	57207-05A	654
53000835ERL	674	53061-00B	166	53930-03B	160	54380-11	154	56263-08	495	57000387EPB	670	57000389ELD	670	57000482ELG	671	57001042ESH	666	57100257EFF	667	57141-05	152	57300-06	83, 108
53000835EUD	674	53070-00A	284	53931-03A	160	54382-11	240	56263-96A	495	57000387ESC	670	57000389ELG	670	57000482ENT	671	57001042ESK	666	57100257EFH	667	57164-10	222	57301-06	83 108, 150
53000835EUF	674	53075-03	160	53932-03A	160	54383-11	241	56266-09	544	57000387ESH	670	57000389ELI	670	57000482ENV	671	57001042ESN	666	57100257EGZ	667	57166-10A	228	57338-08	82
53000836EML	674	53246-09C	268	53953-06	164	54384-11	87	56267-09	543	57000387ESN	670	57000389ENT	670	57000482EOG	671	57001042ETF	666	57100257EKG	667	57185-05	224	57357-07	220
53000836ERL	674	53249-01B	275	53959-06	160	54630-03A	293	56269-09	543	57000387ESU	670	57000389ENX	670	57000482EOR	671	57001042EUZ	666	57100257EKP	667	57200261BYM	666	57400146A	221
53000866EOU	673	53260-09B	266	53961-06	91	54635-09	293	56275-08	497	57000387ETF	670	57000389ENZ	670	57000482ESH	671	57001042EVA	666	57100257ELE	667	57200261DH	666	57400273A	221
53000866ESZ	673	53270-06DH	673	53963-10DH	673	54651-05	177	56275-96B	497	57000387EUZ	670	57000389EOE	670	57000482ESK	671	57001042EVD	666	57100257ELG	667	57200261EGZ	666	57454-10	494
53000866EVO	673	53276-04A	267	53964-06B	91	54758-07	177	56298-03A	544	57000387EVD	670	57000389EOW	670	57000482ESN	671	57001042EWI	666	57100257ENT	667	57200261EKR	666	57457-10	494
53000866EVR	673	53276-09B	267	53968-06C	91	55035-11A	730, 733	56405-08	496	57000387EWX	670	57000389EOX	670	57000482ESS	671	57001042EWX	666	57100257ENV	667	57200261ELG	666	57474-11	537
53000866EXK	673	53301-06	274	54014-05	276	55071-11A	639	56486-01	545	57000387EXU	670	57000389EPB	670	57000482ETF	671	57001042EWZ	666	57100257ENX	667	57200261ENV	666	57485-11	537

57688-10	151	58243-95	151	58900196EFC	665	58900336ETF	665	58900591EVD	665	59664-03	102, 188	61100093B	149, 592	61300461EWX	663	61400412EWK	663	62667-87TA	79, 456	63796-77A	688	66375-97	103
57740-05	225	58277-95	153	58900196EGZ	665	58900336EUZ	665	58900591EWX	665	59685-10	318, 625	61100103A	149, 591	61300461EWZ	663	61400412EWX	663	62668-87TA	456	63797-10	689	66426-04	103
57754-04	153	58278-95	151	58900196EKP	665	58900336EVA	665	58900591EXB	665	60051-01	628	61100107A	81, 149, 592	61300461EXB	663	61400412EWZ	663	62700005A	456	63798-99A	688	66439-07	103
57800-00	325	58298-87	654	58900196ENT	665	58900336EVD	665	58900591EXE	665	60215-06	626	61100117A	591	61300461EXE	663	61400412EXB	663	62700017A	101	63799-10A	689	66441-05	179
57801-11	58	58301-96	223	58900196ENX	665	58900336EWX	665	58900591EXF	665	60277-07	627	61100125A	149, 591	61300461EXF	663	61400412EXE	663	62809-06	457	63805-80A	688	66443-06	103
57802-11	58	58302-96	223	58900196ERI	665	58900336EWZ	665	58900594EVO	665	60280-07	627	61100126A	149, 592	61300461EXU	663	61400412EXF	663	62818-06G	593	63806-00Y	688	66462-07	103
57804-07	225	58303-96	223	58900196ESC	665	58900336EXF	665	58900594EVR	665	60293-00	102	61100129A	591	61308-09A	311	61400412EXU	663	62823-06D	593	63810-80A	688	66477-10	448
57805-03A	279	58308-95	233, 654	58900196ESH	665	58900360ERL	665	58900594EXK	665	60408-09	315	61200008A	587	61335-09A	311	61653-04	80	62823-08D	593	63813-90	688	66543-08	448
57838-08	58, 83	58314-97	223	58900196ESK	665	58900360ERP	665	58900594EXN	665	60514-07A	102	61286-92T	311	61374-04	311	61740-90T	678	62858-99	457	64900186B	353, 381	66718-01	80, 103
57892-11	279	58325-06	219	58900196ESN	665	58900360EUE	665	58900596EUK	665	60529-90A	440, 447	61300049A	311	61400412DH	663	61742-93T	678	62896-00B	456	64900187B	353, 381	67182-07	588
57965-97A	84, 150	58346-06	82, 109	58900196ESS	665	58900360EUK	665	58900598EUE	665	60543-99B	446	61300461DH	663	61400412EFF	663	61769-40T	678	62910-06D	593	64900208A	399	67313-05A	588
57975-99	153	58348-06	82, 109	58900196ESU	665	58900360EWJ	665	58900598EWJ	665	60553-07A	446	61300461EFC	663	61400412EFP	663	61769-47T	678	62946-09A	456	64900209A	399	67315-05A	588
57981-97	219	58350-96	84, 150	58900196ESW	665	58900400EOY	665	58900631EWJ	665	60572-86	440, 447	61300461EFH	663	61400412EGZ	663	61774-51T	678	62955-09A	456	64900552A	350	67516-04B	589
57995-96	219	58387-06	82, 109, 150	58900196ETF	665	58900527EOU	665	58904-03	232, 655	60654-07A	185	61300461EFP	663	61400412EKA	663	61775-59T	678	63002-09A	456	64900553B	350	67516-08	589
58002-09A	235	58397-00	150	58900196EUB	665	58900527ESZ	665	58907-96B	150	60655-07A	185	61300461EFW	663	61400412EKP	663	61776-61T	678	63004-09A	456	64900554B	350	67700093B	601
58022-07A	235	58433-96	219	58900196EUZ	665	58900527EVO	665	59002-98	189, 304	60665-99B	446	61300461EGZ	663	61400412EKR	663	61783-92T	678	63020-04	457	64900555A	350	67700144A	601
58024-96A	59	58444-06	82, 109, 150	58900196EVA	665	58900527EVR	665	59005-98	305	60706-09A	445	61300461EKA	663	61400412ELE	663	61784-92T	678	63023-05	79, 456	64981-09	380	67700145A	601
58063-04	58, 82	58519-07A	231	58900196EVD	665	58900527EXK	665	59027-99	189	60713-07	441, 445	61300461EKR	663	61400412ELG	663	61785-92T	678	63030-09A	456	65100048A	400	67700353A	602
58120-96A	225	58520-79TC	296	58900196EVG	665	58900527EXN	665	59045-00B	303	60715-99B	445	61300461ELG	663	61400412ENT	663	61814-55T	678	63055-09A	456	65100076A	351	67700354A	602
58135-94	219	58602-04	58, 82	58900196EVI	665	58900529EOU	665	59052-98	189, 304	60717-07A	445	61300461ENR	663	61400412ENX	663	61840-94T	678	63065-09A	456	65100084A	351	67700356A	602
58146-07	234	58617-09	82	58900196EWX	665	58900529ESZ	665	59081-96	189, 304	60758-06A	445	61300461ENT	663	61400412EOG	663	62063-01	279	63121-11A	300	65247-09	380	67700426A	600
58156-08A	225	58630-09	82	58900196EWZ	665	58900529EVR	665	59133-99	226	60764-06A	446	61300461ENX	663	61400412EOR	663	62378-10A	311	63131-09A	456	65400137A	401	67700427A	600
58163-02	220	58684-89B	234	58900196EXB	665	58900529EXK	665	59141-98	628	60766-06	440	61300461EOR	663	61400412ESH	663	62600030A	683	63133-10B	81, 591	65400285A	350	67700430A	600
58164-96A	84	58703-09	58, 82	58900196EXE	665	58900529EXN	665	59147-96	188, 305	60782-06A	446	61300461EOX	663	61400412ESK	663	62600031A	683	63134-10B	81, 591	65948-00C	717	67700433A	600
58165-09	150	58706-09	58, 82	58900196EXF	665	58900591BYM	665	59209-91T	189, 302	60826-11	435	61300461ESC	663	61400412ESN	663	62600038A	684	63139-10B	81, 591	65958-04C	717	67700555A	21
58187-96	223	58770-96	150	58900336DH	665	58900591DH	665	59228-91	188, 305	60867-08	184	61300461ESH	663	61400412ESS	663	62600041A	684	63140-10B	81, 591	65989-90B	717	67734-88T	610
58189-98	233, 654	58772-97	152	58900336EGZ	665	58900591EGZ	665	59369-97	189	60868-10	447	61300461ESN	663	61400412ETF	663	62600042A	684	63692-00A	457	65989-97E	717	67735-91T	610
58192-87A	59, 84	58900-11	232	58900336ENT	665	58900591ESN	665	59500105BEO	301	60876-11A	444	61300461ESS	663	61400412EUZ	663	62600043A	684	63698-02	457	65991-82B	717	67737-88T	610
58195-94	219	58900196BEO	665	58900336ESH	665	58900591ESS	665	59500245A	301	60885-10	447	61300461ETF	663	61400412EVA	663	62600084A	684	63731-99A	688	66006-29F	717	67738-91T	610
58207-04	224	58900196DH	665	58900336ESK	665	58900591EUB	665	59500246A	301	60886-11A	444	61300461EUZ	663	61400412EVD	663	62600085A	684	63793-01K	688	66010-82B	717	67750-88T	610
58221-04	219	58900196EEM	665	58900336ESN	665	58900591EUZ	665	59582-02A	188, 305	61100006B	591	61300461EVD	663	61400412EVG	663	62600089A	684	63794-10	689	66010-97E	717	67751-91T	610
58240-95	151	58900196EEZ	665	58900336ESS	665	58900591EVA	665	59651-01	189, 304	61100007B	591	61300461EWI	663	61400412EWI	663	62600090A	684	63795-10	688	66375-06	103	67752-77T	610

67761-96	610	68328-06A	711	69304-02	613	69793-07	610	71790-05	309	74667-06	102			76000497DWC	667	76000497EWZ	667	83976-10	279	90200826EOG	669	90200827EEN	669	90200827ESS	669
67774-10	318, 625	68332-08	626	69307-02	618	69795-07	610	71802-03	513	74682-10	589			76000497EEZ	667	76000497EXB	667	83989-10A	325	90200826EOR	669	90200827EEV	669	90200827ESU	669
67783-78T	610	68348-05	604	69308-02	618	69817-07A	625	71804-03	513	74683-10	589			76000497EFF	667	76000497EXE	667	84031-11	276	90200826EOW	669	90200827EFC	669	90200827ETF	669
67791-91T	610	68358-07A	318, 625	69309-10	711	69820-06	620	71813-09	512	74688-10	589			76000497EGZ	667	76000497EXF	667	88232-06	276	90200826EPB	669	90200827EFF	669	90200827ETX	669
67796-91T	610	68388-10	271	69366-07	625	70113-08	268	71816-09	513	74689-10	589			76000497EKA	667	76000497EXU	667	88299-09	271	90200826ERG	669	90200827EFH	669	90200827ETY	669
67800366A	605	68411-10	618	69461-06D	620	70213-02C	517	71826-11	512	74690-10	589			76000497EKG	667	76000582A	585	90200826BYM	669	90200826ERI	669	90200827EFM	669	90200827EUZ	669
67800367A	605	68435-10	618	69462-06D	620	70222-96B	512	72673-11	586	74691-10	589			76000497EKP	667	76000746A	574	90200826BYZ	669	90200826ESC	669	90200827EFU	669	90200827EVA	669
67800802A	128	68517-94A	59, 619	69492-05	612	70228-96C	512	73294-10	179	74692-10	589			76000497EKR	667	76000747A	567, 574	90200826DH	669	90200826ESH	669	90200827EGZ	669	90200827EVD	669
67800830A	128	68544-10	96	69577-06A	612	70239-07	517	73342-09	611	74774-11D	587			76000497ELD	667	76000829A	575	90200826DWC	669	90200826ESK	669	90200827EKA	669	90200827EVG	669
67890-91C	179	68611-98	620	69604-03A	608	70248-02B	517	73343-09	611	74775-11C	587			76000497ELE	667	76000834A	575	90200826DZN	669	90200826ESN	669	90200827EKG	669	90200827EWC	669
67891-99	179	68615-04	620	69622-99B	606	70255-02B	517	73344-09	611	74776-11D	587			76000497ELG	667	76312-98	584	90200826DZT	669	90200826ESS	669	90200827EKP	669	90200827EWI	669
68000123A	620	68617-04	620	69623-99A	606	70264-94A	322, 586	73415-11	95, 164	74777-11C	587			76000497ELI	667	76386-08	585	90200826EEN	669	90200826ESU	669	90200827ELD	669	90200827EWK	669
68000190A	598	68643-09	59, 619	69624-99A	606	70270-04A	322, 586	73416-11	624	75008-02A	725			76000497ENR	667	76386-09A	585	90200826EEV	669	90200826ETF	669	90200827ELE	669	90200827EWX	669
68000191A	598	68669-05A	604	69626-99	606	70683-08	68	73420-11	624	75012-82D	590			76000497ENT	667	76388-08	585	90200826EFC	669	90200826ETX	669	90200827ELG	669	90200827EWZ	669
68006-83T	626	68732-02A	96	69627-99	606	70900070B	587	74538-09	303	75014-06D	593			76000497ENV	667	76572-09	581	90200826EFF	669	90200826ETY	669	90200827EMA	669	90200827EXB	669
68011-91T	626	68733-02A	96	69732-05	607	70900071A	587	74541-00	306, 590	75027-08D	593			76000497ENX	667	77117-10	584	90200826EFH	669	90200826EUZ	669	90200827ENR	669	90200827EXE	669
68055-10BHP	179	68775-93TA	610	69733-05	607	70900072A	587	74543-00	303	75031-09	78			76000497ENZ	667	79179-08	269	90200826EFM	669	90200826EVA	669	90200827ENT	669	90200827EXF	669
68127-10	618	68926-00	710	69734-05	607	70900100C	78, 587	74550-92T	306	75098-08A	593			76000497EOG	667	79192-10	265	90200826EFU	669	90200826EVD	669	90200827ENV	669	90200872DH	315
68128-10	618	68926-07	710	69735-05	607	70900465A	310	74552-04A	589	75110-98B	725			76000497EOW	667	79211-08A	312	90200826EGZ	669	90200826EVG	669	90200827ENX	669	90201078DH	668
68129-97	85	68927-00	710	69736-02	611	70900773B	589	74553-04A	589	75113-04A	589			76000497EOX	667	80503-07	399	90200826EKG	669	90200826EWC	669	90200827ENZ	669	90201078EOG	668
68129-98DH	85	69036-88A	631	69738-05	607	70900777B	589	74554-04	589	75113-08	589			76000497ESC	667	80611-09	353, 381	90200826EKP	669	90200826EWI	669	90200827EOB	669	90201326A	71
68185-00	619	69039-09A	630	69739-01	611	70900778B	589	74562-98	306	75133-99	590			76000497ESH	667	80716-08	381	90200826ELD	669	90200826EWK	669	90200827EOE	669	90201513A	129
68189-07A	631	69060-90H	80, 629	69740-01	606	71031-04	712	74567-11	187	75137-98B	725			76000497ESK	667	80726-09A	399	90200826ELE	669	90200826EWX	669	90200827EOG	669	90201552A	128
68200-00D	711	69112-95E	80, 631	69749-05	607	71040-04	712	74584-99	308	75158-10	725			76000497ESN	667	80794-10A	379	90200826ELG	669	90200826EWZ	669	90200827EOR	669	90201555A	129
68200-07A	711	69153-03A	618	69752-04	611	71282-04	102	74597-01	187	75327-09D	593			76000497ESS	667	80821-10	380	90200826EMA	669	90200826EXB	669	90200827EOW	669	90201561A	128
68207-00D	711	69166-01B	631	69753-04	611	71283-01	178	74604-99	308	75357-10A	593			76000497ESW	667	83324-09B	738	90200826ENR	669	90200826EXF	669	90200827EPB	669	90201645A	130
68207-07A	711	69201599A	322, 586	69756-05	611	71500186A	513	74612-06	306	75358-10A	593			76000497ETF	667	83825-09B	324	90200826ENT	669	90200827BYM	669	90200827ERG	669	90201905EHT	668
68208-98A	604	69208-09	613	69757-05	611	71500187C	513	74616-04	102, 187	76000232C	575			76000497EUZ	667	83841-09	324	90200826ENV	669	90200827BYZ	669	90200827ERI	669	90201905EHX	668
68227-09	91, 96	69228-04	605	69758-05	611	71500228C	513	74622-04	323	76000277B	570			76000497EVA	667	83843-09	324	90200826ENX	669	90200827DH	669	90200827ESC	669	90201906EHT	669
68250-08A	269	69234-04	605	69759-05	611	71500248C	516	74622-06	323	76000278A	564, 570			76000497EVD	667	83911-09B	723	90200826ENZ	669	90200827DWC	669	90200827ESH	669	90201906EHX	669
68311-01	626	69235-04	605	69760-05	611	71500250B	516	74622-09	323	76000486A	576			76000497EWI	667	83946-11	319	90200826EOB	669	90200827DZN	669	90200827ESK	669	90201907EHT	669
68317-06A	711	69303-02	613	69761-05	611	71718-02	517	74661-04	309, 590	76000497DH	667			76000497EWX	667	83968-10	279	90200826EOE	669	90200827DZT	669	90200827ESN	669	90201907EHX	669

768 PART#/PAGE# REFERENCE

90201953ELD	668	91672-07	713	92023-03A	509	94131-93T	461	94684-00A	719	98170-88T	656
90201953ELE	668	91684-08A	711	92059-07A	506	94132-93T	461	94686-00	689	98185-90T	656
90202005EOX	668	91697-06A	508	92068-08A	506	94133-01	503	94697-08	718	98187-90T	706
90202534DH	131	91718-02	679	92189-06	274	94135-93T	629	94704-10	706	98196-85T	656
90238-00	174	91722-04	657	92190-06	508	94139-01	503	94705-10	706	98197-85T	656
90300096A	310	91723-02	679	92416-08	508	94140-02	503	94708-98	77, 645	98198-85T	656
90465-98A	64	91743-87T	655	92423-08A	508	94207-04	461	94755-99	309	98199-85T	656
90564-06D	96	91744-87T	655	92441-10	508	94208-04	461	94773-00A	645	98600BF	676
90853-06DH	314	91745-02	679	93024-88	657	94280-04	463	94773-07	645	98600BY	676
90857-06DH	314	91773-85	655	93036-95	657	94281-04	463	94778-10	699	98600EK	676
90876-05	166	91811-85	679	93037-09	657	94289-94T	159	94793-01	718	98605AX	676
90881-09A	272	91815-85	679	93300054B	232	94291-04A	463	94819-02	719	98605BF	676
90892-09	270	91840-03B	509	93600057A	699	94415-05	176	94830-02	461	98606BF	676
91080-93	189	91845-03B	509	94055-03	463	94435-10	718	94832-02	461	98606BY	676
91099-94A	302	91846-03B	509	94056-03	463	94448-82B	718	94844-10	698	98606EK	676
91100-09	302	91848-03B	509	94058-03	463	94451-05	545	94863-10	689	98628EK	676
91124-03A	515	91857-91	657	94059-03	463	94452-05	545	94868-10A	707	99000-77	679
91135-09	102, 178	91864-90T	509	94068-03	463	94453-05	545	94869-10A	707	99020-90T	677
91194-04	188	91866-90T	509	94109-95	629	94454-05	545	94871-10	708	99027-90T	679
91195-04	188, 304	91885-97A	277, 653	94111-95	153, 464	94546-05	628	94873-10A	707	99352-82Z	679
91216-97	270	91887-98	277, 653	94114-02	628	94616-98	658	94901-03	659	99539-97	677
91315-04	508	91907-87	509	94116-93T	464	94624-97B	716	94902-03	659	99650-02	691
91347-00	644	91909-03B	509	94117-93T	464	94625-98	658	94923-09	460	99661-92T	297
91402-00	189	91910-03B	509	94119-93T	464	94626-98	658	94924-09	460	99663-92T	297
91558-01B	704	91930-92T	509	94120-93T	464	94630-98	461	94943-07	460	99669-04	677
91561-01B	704	91931-92T	509	94121-93T	464	94631-98	461	94968-09	691	99670-04	677
91562-01	704	91945-98B	308, 506	94122-93T	464	94640-08	703	95615-04	645	99688-10	677
91573-09A	288	91968-98	508	94124-93T	464	94641-08	703	95982-98B	713	99821-09	716
91615-09A	96	91971-98	508	94125-93T	464	94647-98	713	96396-09	306	99825-02	676
91660-06	713	91982-03B	509	94126-93T	464	94650-98	706	97008-07	656	99828-09	716
91668-05	249	91983-03B	509	94127-93T	464	94651-09	699	97410-10	689	99856-92	691
91671-10	321, 583	92022-03A	509	94130-93T	461	94669-00	718	98169-88T	656	99857-97A	691

ONE-YEAR OVER-THE-COUNTER PARTS AND ACCESSORIES WARRANTY

Harley-Davidson warrants that street legal Genuine Motor Parts (“Parts”) and street legal Genuine Motor Accessories (“Accessories”) that are purchased on or after January 1, 2012 through an authorized dealer will be free from factory defects, under normal use and service, for a period of one year starting from the date of retail sale and delivery (not date of installation). Because this limited warranty covers only Parts and Accessories, labor is not covered. This limited parts warranty does not cover defects or damage due to abuse, misuse or improper installation. This parts warranty applies to Parts and Accessories you or an aftermarket shop have installed, but only for defects in manufacturing — not conditions caused by the improper installation.

This Parts and Accessories warranty is separate and distinct from the limited factory warranty that applies to your stock motorcycle. This Parts and Accessories warranty does not extend or modify the factory warranty that applies to your motorcycle. It only covers the street legal Genuine Motor Parts and street legal Genuine Motor Accessories added to your motorcycle.

This Parts and Accessories warranty does not cover defects, damage or premature wear to your motorcycle that are caused by the installation or use of Parts and Accessories, even those installed by an authorized dealership. Examples include, but are not limited to performance-enhancing powertrain components or software, exhaust systems, non-approved tires, lowering kits, handlebars, add-ons connected to the factory electrical system, etc.

The fact that Parts or Accessories are labeled or branded Harley-Davidson, or are sold or installed by an authorized dealership, does not necessarily make them appropriate or warranted for the make and model of your motorcycle. The use of Parts and Accessories not designed and tested for your motorcycle may have negative consequences on the performance of your motorcycle and may create conditions not covered by the limited factory warranty.

The remedy for breach of this limited Parts and Accessories warranty is expressly limited to the repair or replacement of any component that proves to be defective, and does not extend or create liability for consequential damages, costs or expenses, including loss of time, inconvenience, or loss of use of the motorcycle. Any implied warranty, including warranty of merchantability or fitness for a particular purpose, is expressly limited to the duration of this limited one-year Parts and Accessories warranty, or to the shortest duration permitted by the laws in your state.

EXCLUDED COMPONENTS:

All Genuine Motor Parts & Accessories will qualify for the one-year over-the-counter warranty, with the following exceptions:

- Tires
- Chemicals
- Premium Luggage (two years)
- Audio and Navigation (see Radio/Electronic Warranty Matrix on h-dnet.com)
- Non-street legal components (including Screamin’ Eagle® Pro)
- Anything with a manufacturer/factory warranty
- Other disposable and consumable items

To obtain warranty service, return the affected component(s) with proof of purchase, at your expense, within the limited warranty period to an authorized Harley-Davidson® dealer.



Harley-Davidson Parts and Accessories Division, a facility of Harley-Davidson Motor Company, is registered to International Quality Standard ISO 9001:2015.

The sale or use of these parts or accessories does not grant the purchaser a license or other right under any Harley-Davidson patent.

IMPORTANT – PLEASE READ: We have tried to make this catalog comprehensive and factual. All product descriptions (including depictions, specifications, dimensions, measurements, ratings and competitive comparisons) are based on available information at the time of publication. Although such descriptions are believed correct, errors and changes can occur and complete accuracy cannot be guaranteed. Harley-Davidson may make changes at any time to prices and specifications, and may change or discontinue any of the items depicted in this catalog without notice, and without incurring any obligation.

ATTENTION: Vehicles in the configurations shown and the accessories described in this catalog may not be available for sale or use in some locations. Please check with your dealer for complete product details and the latest information.

NOTICE: Selection varies by dealership. Prices listed are generally the Manufacturer’s Suggested Retail Price (MSRP), excluding taxes and shipping, and are subject to change without notice. Prices at local dealerships may vary. All online orders will be fulfilled and shipped by Harley-Davidson Motor Company as the agent for the Selling Dealer. All taxes are extra. Harley-Davidson reserves the right without prior notice to discontinue at any time any of the items herein or change specifications or designs without incurring any obligation to the customer. All items are subject to availability and prior sale by our dealers.

TRADEMARKS: Adversary, Aluminator, Badlander, Bar & Shield logo, Blackline, Boom!, Brawler, Breakout, CoolFlow, Cross Bones, Custom Vehicle Operations, CVO, Dark Custom, Daymaker, Destroyer, Deuce, Diamond Back, Diamondback, Digital Technician, Dominion, Dyna, Electra Glide, Electra Glo, Empire, Evolution, Fat Bob, Fat Boy, Forty-Eight, Freewheeler, FXDR, Get-A-Grip, Hard Candy Custom, Harley, Harley-Davidson, Harley-Davidson Street, Harley Owners Group, HD, HDMC, H-D, H-D Connect, H-D Prodigy, H-D1, Heritage Softail, Heritage Springer, H.O.G., HOG, Hog Ties, HoldFast, Hugger, Iron883, Knockout, Kahuna, LiveWire, Low Rider, Nightster, Night Rod, Night Train, Nightster, Onyx, Pan America, Profile, Reach, Revolution, Revolution Max, Revolution X, Ride Free, Road Glide, Road King, Roadster, Road Tech, Road Zeppelin, Rocker, Screamin’ Eagle, Seismic, Seventy-Two, Signature Series, Softail, Softail Slim, Spectra Glo, Sport Glide, Sportster, Springer, Street, Street Bob, Street Glide, Street Rod, Street Stalker, Sturgis, Sundowner, Sun Ray, Sunwash, Super Glide, SuperLow, SuperLow 1200T, Switchback, SYN3, Tallboy, Tour Glide, Tour-Pak, Tri-Glide, T-Sport, Twin Cam 88, Twin Cam 88B, Twin Cam 96, Twin Cam 96B, Twin Cam 103, Twin Cam 103B, Twin Cam 110, Twin Cam 110B, Twin-Cooled, Ultra Classic, Voltaic, V-Rod, V-Rod Muscle, VRSC, Wide Glide, Willie G, XR1200, XR1200X, 80Grit and the Harley-Davidson Genuine Motor Parts and Genuine Motor Accessories Logo are among the trademarks of H-D U.S.A., LLC.

3M, AGM, Allen, Apple, Bluetooth, Brembo, City Navigator, Cordura, Dow Corning, Dunlop, Galaxy5, Google, Hylomar, iPhone, iPod, Kevlar, Loctite, Michelin, NavTraffic, NavWeather, Ohlins, PJ1, QuickTite, Rockford Fosgate, Samsung, Scorcher, Scotchlite, SD, Showa, Sirius, SiriusXM, Teflon, Threadlocker, Velcro, Wounded Warrior Project, Windows, Xenon, XM, zūmo and all other marks are trademarks of their respective owners.



The only way to get Genuine Motor Parts and Accessories is through an authorized Harley-Davidson® dealer or directly from h-d.com/parts. You can ship your online orders to your local participating Harley-Davidson® dealership where you can pick them up — for free. For your nearest local dealership, please visit our dealer locator at h-d.com/dealer.

We care about you. When riding your Harley-Davidson® motorcycle, be sure to ride safely, respectfully and within the limits of the law and your abilities. Always wear an approved helmet, proper eyewear and protective clothing, and insist your passenger does too. Never ride while under the influence of alcohol or drugs. Know your Harley-Davidson® motorcycle, and read and understand your owner's manual from cover to cover. Sign up for a Harley-Davidson® Riding Academy course (visit harley-davidson.com for a course near you) or Motorcycle Safety Foundation rider course (call 1-800-446-9227 for a course near you). Protect your privilege to ride by joining the American Motorcyclist Association. Visit americanmotorcyclist.com for more information.

The sale or use of these parts or accessories does not grant the purchaser a license or other right under any Harley-Davidson patent.

©2023 H-D or its Affiliates. H-D, Harley, Harley-Davidson and the Bar & Shield Logo are among the trademarks of H-D U.S.A., LLC. Third-party trademarks are the property of their respective owners.
94500352